

Standard Range
Catalogue **4.0**

NEW



air technology



Code index, new products, information for project planning

2
20

Small room, wall, in-line duct, window, ceiling fans and fan heaters



Controlled residential ventilation according to DIN 18017-3

Mono tube ventilation system ultraSilence® ELS
Central ventilation system ZLS
Central ventilation box ZEB

EcogreenVent®

42



KWL® ventilation systems with heat recovery
KWL® periphery

EcogreenVent®

76



Ex Low and medium pressure axial fans
Ex RADAX® VAR high pressure fans

EcogreenVent®

138



Box fans

GigaBox
MegaBox
Fresh air box

Ex

EcogreenVent®

234



In-line fans

MultiVent®
1 ph. small fans RRK Ex e II 2G
RR, RRK and SlimVent® SV
AcousticLine SilentBox® SB and SlimVent® SVS

Ex

EcogreenVent®

294



Rectangular fans

Ex Forward curved
Backward curved
AcousticLine, sound-insulated

Ex

EcogreenVent®

370



Air treatment

Filters, heater batteries and control systems, attenuators

421



Roof fans

Ex Vertical and horizontal discharge
Diagonal discharge

Ex

EcogreenVent®

437



Accessories

Shutters, grilles, ventilation valves, wall/roof terminations, fire protection systems and shutter elements

487



Measure. Control. Regulate.

EcogreenVent®

525

Type	Page	Type	Page	Type	Page
ABV Abluvent extract / intake grille	504	DSEL Dual speed controller	528	ELF-ZS Spare filter for ELS-ZS	61
ACL Air quality controller/sensor	543	DSTS / DSTS Ex Flanged flexible connector (roof)	485 443 on	ELFZ / ELF-ZLE Spare filter for ZLA / ZLE	513
AE Air extract elements	501 on 68, 74	DSZ Speed controller	528	ELS ultraSilence® Mono tube ventilation system	46 on 56
ALB Fresh air boxes and accessories	284 on	DVAM / DVAW Ceiling fans	38	- Casings flush/surface mount.	58
ALEF Air intake element	515 61, 68, 74	DV EC Roof fan with EC technology	444 on 65 on	- Fan units	60
ALF Helioflex ducting	496, 75	DVS Backdraught shutters (for roof fans)	485 443 on	- Accessories	60
AMD / AMW Medium pressure axial fans	180 on	DVW Ceiling fans	38	ELS-D Fire damper	522 61, 69
AS Spigot plate	496	DX Centrifugal fans, Ø 100 mm	32	ESA / ESU Electronic speed controllers stepless, for 1 ph. fans	531
ASD / ASD-SGD Bell mouth + guard	231	EBR Mounting rings for valves	508 on	ESD Electronic speed controllers stepless, for 3 ph. fans	535
AV External wall fan	34	EC fans Types with EC technology	Overview see page 1	ESE Built-in speed controllers	531
AVD DK / RK High performance axial fans short inlet cone / short cased	172 on	EDR Electron. pressure controller	540	EST Four step thermostat	534
BAE / BAK Fire protection shutter, damper	518 68	EDT Differential temp. controller	543	ETR Electronic temperature controller	540
B-ALB Operating switch for ALB	287, 289	EH Mounting sleeve	518	ETS Cross talk attenuators	505
BA-S Limit switch (accessories BAE/BAK/BTK)	518 on	EHR-K / EHR-R TR Electric heater batteries	425, 428	ETW Electronic transformer controllers for 1 ph. fans	535
BLS Fire protection ventilation brick	524	EHS / EHSD Electronic temperature control system for EHR	427	EUR 6 C / EUR EC Universal controller	538
BM Pipe clamp connectors	320 on	EKL Spare filter cassettes (for KLF)	423	EVK Electrical louvre grilles	488
BSX Reversing switch	531	ELF Spare filter mats (for LF and LFBR)	422, 424	F Adaptors for square shutters	496
BTV / BTK Fire protection valve, damper	520	ELF-ABV Spare filter mats for ABV	504	F Flat duct system, polymer	133
DDF Roof outlet	495	ELF-ALB Spare filter for ALB	287 on	FAP Flange connecting plate	69
DDS Differential pressure switch	542	ELF-DLV Spare filter for DLV	507	FDH Flat roof cowl	494
DFR Counterflanges (roof fans)	485 443 on	ELF / ELS Perm, filter for ultraSilence® ELS	61	FDP Flat roof pan tile (for DH)	494
DH Roof cowl	494 75	ELF-KWL Spare filter for KWL® units	81 on	FDS Roof purlin box (for roof fans)	486 443 on, 69
DLV / DLVZ Design ventilation valve	506	ELF-LEWT Spare filter for LEWT-A	121	FES Window mounting kit	29, 36
DR Mounting kits for double glazing	37	ELF-SEWT Spare filter for SEWT-W	119	FF Flat flange	143 on, 232
DRVM / DRVS Backdraught shutter (roof fans)	485 443 on	ELF-VFE Spare filter for VFE	504	FK Flat duct system, galv. steel	134
DS Star / Delta switch	529			FM / ..Ex / ..T120 Flexible sleeves	232 317, 266 on

Type	Page	Type	Page	Type	Page
FR Coupling flange – for in-line fans – for roof fans	232, 143+211 on 485, 443 on	HWD / HWW / ..EC High performance axial fans, low pressure, with inlet cone Types with EC technology	154 on 142 on	M1 MiniVent® small room fans connection Ø 100, 120, 150 mm	22 on
FR Operation switch for window fans GX	528 37	HY Hygrostat	542	M Full motor protection switch	530
FRS FlexPipe® plus Flexible duct system, round + oval Design grille	128 on 125	IP IsoPipe® Insulated ducting system	122 on	MBD / MBW / ..EC MegaBox centrifugal fans Types with EC technology	275 on 266 on
FRS FlexPipe® Flexible duct system, round	132 on	JVK Volume control dampers	420	MBR Mounting plate for M1/100, HR 90 KE	23, 29
FSD Flexible attenuator	435	KAK Cold smoke shutters	523	MD / MW Full motor protection unit	530
FSK Adapting plate, rect. / circular	375 on	KLB Sealing strip	123, 133 on	MF Spacer frame for M1/100, HR 90 KE	23, 29
FU Frequency inverter	536	KLF Rectangular filter	423	MK Mounting feet – for centrifugal in-line fans – for axial, VAR fans	317, 323 on 233
G Fixed grilles	492	KR Wall sleeve for wall installation	37	MRV Mounting ring	233
GBD / GBW / ..EC GigaBox centrifugal fans Types with EC technology	248 on 239 on	KRD / KRW / ..EC InlineVent® rectangular fans Types with EC technology	406 on 390 on	MSA Full motor protection unit	530
GF Coupling flange	420	KSB Cold shrink tape	135	MTVA / MTVZ Metal valve, extract/supply air	508 510
GVK Twin swing shutter (access. HV)	31	KSD Rectangular attenuator	435	MV / ..EC MultiVent® in-line fans Types with EC technology	304 on 300 on
GX Window fans up to 1600 m³/h	37	KTRD / KTRW Clim. trans. contr., 400 V / 230 V	534	MVB Operation switch	23 on, 32 305 on
HDH Roof cowls	484	KTVA / KTVZ Polymer two way valves	509, 511	MVS Guard	305 on
HQD / HQW / ..EC High performance axial fans, low pressure, with square plate and inlet cone Types with EC technology	154 on 142 on	KVD / KVV InlineVent® rectangular fans, forward curved	374 on	MWS 5-step transformer controller	532
HR HelioVent® Mini fans with electric shutter	28	KWL® Ventilation systems with heat recovery and accessories	76 on	NG 24 Mains adaptor for EDR / ETR	540
HRFD / HRFW / ..EC High performance axial fans, low pressure, cylindrical duct and flanges on both ends Types with EC technology	154 on 142 on	LDF Differential pressure sensor	538	PA / PU Speed potentiometer	541
HSD / HSW High performance axial fans, low pressure, cylindrical duct and spigot ends	138 on	LEWT Ground-to-air heat exchanger	120	PDA / PDU Pole switches for Dahlander windings	529
HSDV Roof fan attenuator (for roof fans)	484	LF / LFBR Air filter / Air filter box	422, 424	PGWA / PGWU Pole switches, for separate windings	529
HV HelioVent® wall fan 450, 840 m³/h	31	LGF Air flow speed sensor	538	PWDA / PWGW Reversing and pole switch	529
HVR HelioVent® flush-mounted wall and window fans	30 36	LGK / LGM Int./extr. grilles, polymer/metal	493	QVK Ventilation grille, adjustable	492
		LGR Ventilation grille, adjustable	492	RAG Rain-repellent grille	491
		LTA Outdoor temperature sensor	538 on	RDD / RDW / ..EC Centrifugal roof fans, horizontal discharge Types with EC technology	460 on 450 on
		LTGB / LTGW Door grilles	493		
		LTK / LTR Duct/room temperature sensor	538 on		

Type	Page	Type	Page	Type	Page
RDS 5-step transformer controller	533	SGR Guard for RRK Ex / RR	317 323 on	UDP Universal pan tile (for DH)	494
REW Axial in-duct fans	33	SH Stationary heater fan	41	VARD / VARW High pressure in-line fans	206 on
RHS Isolator switch	529	SKRD / SKRW / ..EC InlineVent® rectangular fans, sound insulated Types with EC technology	410 on 394 on	VDD / VDW Centrifugal roof fans, vertical discharge	460 on
RP RenoPipe Air distribution system	126	SSD Base attenuator (for roof fans)	486 443 on	VDR Centrifugal roof fans, vertical discharge	458
RR / RRK / ..EC Centrifugal in-line fans made from steel or polymer Types with EC technology	330 on 320 on	STH Electric fan heater	40	VFE Adapter filter element	504
RRK Ex Centrifugal in-line fans, explosion-proof	316	STM Servo motor for dampers, auxiliary switch (access. JVK)	420	VH Extension tube	155 on
RS Isolator switch	484, 528	STS / STS Ex Flanged flexible connector – for axial in-line fans – for roof fans	232, 143 on 485, 443 on	VK Gravity shutter, automatic	488
RSD Flanged circular attenuator	436	STSSD / STSSW Five step rotary switch for TSSD / TSSW	532	VKH Constant air flow vol. controller	498
RSK / RSKK Backdraught shutter	490	STV Pipe joint (accessories DH)	494	VR Extension duct	232
RVB / RVBD Duct connector / with seal	496	SVV / SVR / ..EC Centrifugal in-line fans Types with EC technology	319, 330 on 320 on	VS / VS Ex Rectangular flexible connector	420
RVE In-duct backdraught shutter	490	SVS / ..EC Centrifugal in-line fans, sound insulated Types with EC technology	358 on 344 on	WDS Soaker sheet (for roof fans)	486 443
RVK Manual grille, adjustable	488	SVE Sound insulation element	497	WER Wall sleeve for flush-mounting on wall (accessories HV, GX)	31, 37
RVM / RVS Backdraught shutter	490	SWE / SWT Electronic air flow switch	543	WES Wall mounting kit	23 on
RZ Duct reducers	496	TFK / TFR Duct / room sensor (for EHS, EHR-R, ALB)	427 287, 289	WHR Warm water heater battery	429
SA / SU Three step switch	541	TFR-ALB Room temp. sensor for ALB	287, 289	WHST 300 T38 / T50 Temperature control systems for warm water heater battery WHR	431 137
SB Ladder strips (for GX)	37	TH Electric fan heater	40	WHS HE / WSH HE Temperature control system	432
SB / SBD / ..EC SilentBox®, in-line fans Types with EC technology	358 on 344 on	TME Thermostats	542	WS Reversing switch	528
SCH Worm drive clips	496	TMK Telescopic wall kit	495	WSG External louvre	491
SDD / SDZ Anti-vibration mounts	233	TS T-pieces	496	WSUP / WSUP-S Timer clock	527
SDE Attenuators (for KWL® units)	137	TSD / TSSD 5 step transformer for 3 ph. fans	533	Z Overrun timer	527
SDH Pitched roof outlet	495	TSW / TSSW 5 step transformer for 1 ph. fans	532	ZAV Supply-extract air valve	136
SDS Sloping roof base for roof fans	486 443 on	TWH Telescopic wall sleeve	23 on 31, 37	ZEB / ..EC Central ventilation box Type with EC technology	70 on
SEWT Ground-to-brine heat exchanger	118			ZLA / ZLE Intake air machine / element	513
SG Guard	231			ZLS-DV EC Central ventilation system	65 on, 444 on
				ZTV Thermostat valve, supply air	512

Axial fans with smaller power ratings

Series MiniVent® M1, HR 90 KE, HV, REW, GX

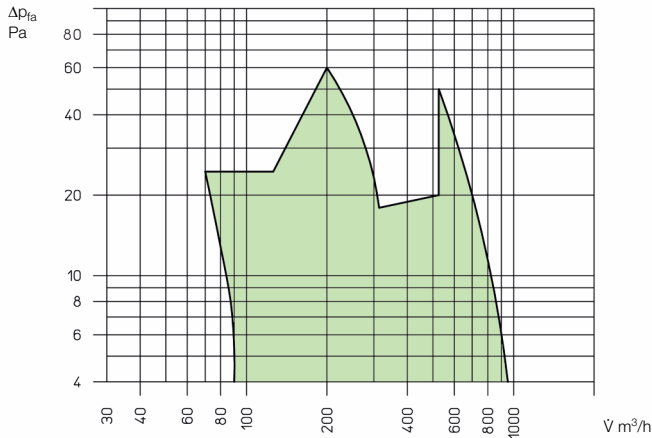

High performance axial fans

from 200 – 1000 mm \varnothing , series HQ, HW, HS, HRF, AMD, AVD

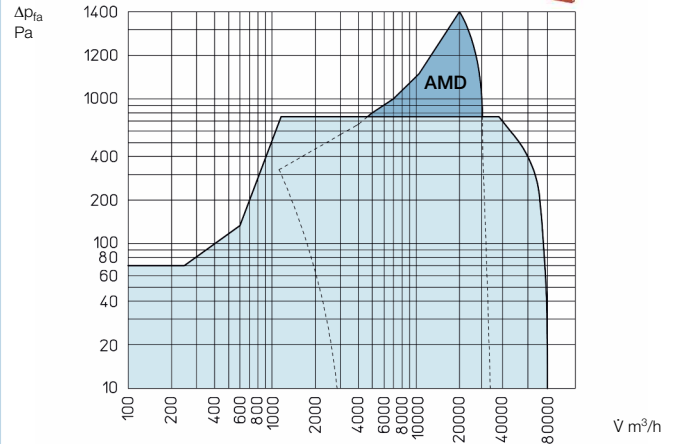

Centrifugal in-line and rectangular fans, fresh air boxes, etc.

Series AV, DX, MV, RR, SB, SV, KV, KR, SKR, ALB

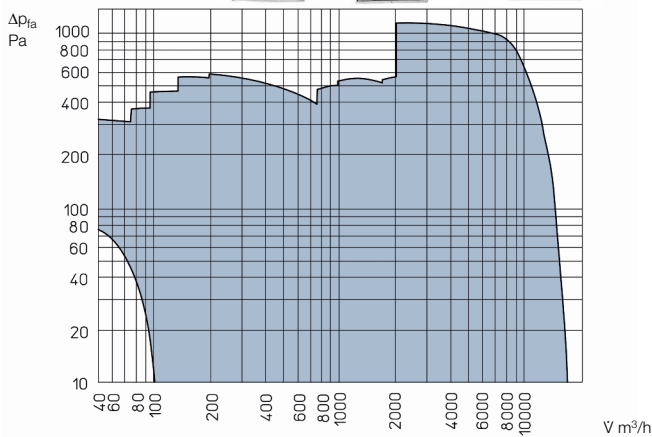

Centrifugal roof fans

Series DV EC, VDR, VD, RD

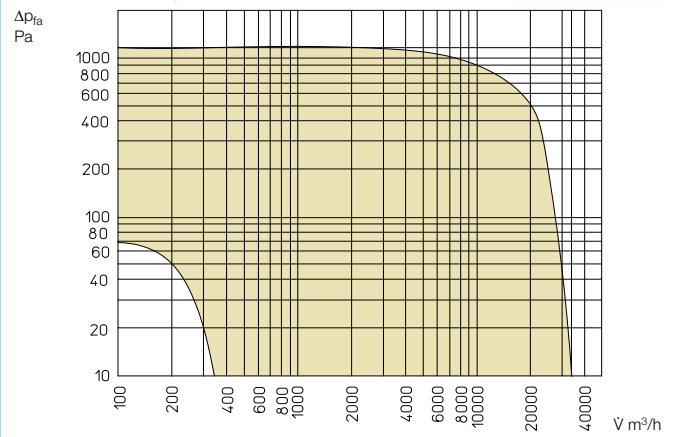

High-pressure in-line and centrifugal fans

Series VAR, MB, GB

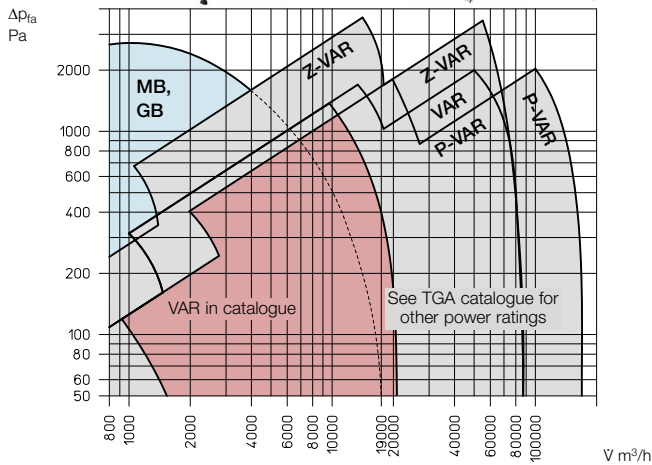

Large axial fans

from 1000 – 7100 mm impeller \varnothing

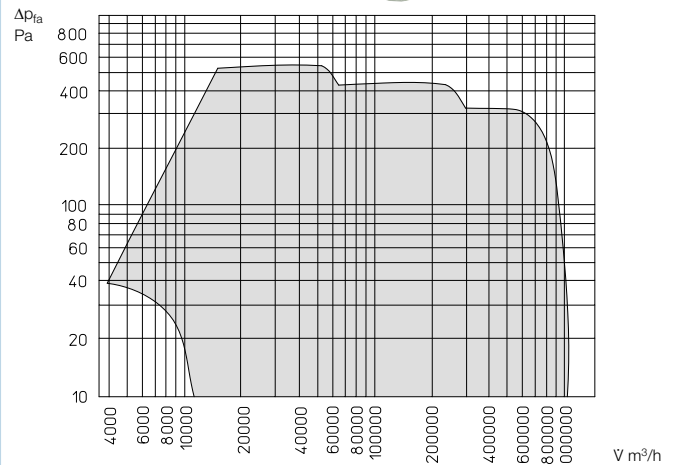

Comfortable climate and energy saving.
For low-energy and passive house,
multi-storey constructions and commerce.

THE NEW KWL EC SERIES "S"

For standing, space-saving floor installation. With air flow rates from 800 to 2600 m³/h and fresh powerful look. Ideal for use as central units with heat recovery in residential, commercial and industrial applications.

Certified pursuant to passive house standard including special control technology for constant volume or constant pressure control. Optional with integrated PWW heater battery.

106^{on}



FLUSH-MOUNTED WALL INSTALLATION

KWL EC 45, KWL EC 60 for flush-mounted wall installation in single rooms, ideal for refurbishment.

WALL INSTALLATION "W"

Compact wall units from 200 to 500 m³/h. KWL EC 270, 370 W with passive house certificate. All models come with easyControls as standard and optionally with enthalpy heat exchanger.

CEILING INSTALLATION "D"

Ultra-flat units from 220 to 2000 m³/h for space-saving ceiling installation. With highly efficient heat exchanger, EC technology and passive house certificate. KWL EC 220, 340 D with easyControls as standard.

KWL® PERIPHERY

Ideally coordinated accessories, such as the ground heat exchanger and the active humidification unit HygroBox, for the functional enhancement of the entire KWL® system. Innovative air distribution systems for all installation types and areas of application. Design ventilation valve, and much more.

80^{on}

96^{on}

114^{on}

EC FANS VENTILATION OF THE FUTURE



**Energy – the future topic.
Efficiency – the requirement
of our time.**

The complete EC fan range from Helios contains over 100 types in 14 series with performance ranges from 300 to 20 000 m³/h.

Depending on the type, the EC axial, box, in-line, rectangular and roof fans with speed control achieve savings of 40 to 70% compared to conventional AC fans.

MEDIUM-PRESSURE AXIAL FANS



**Innovative axial impeller and
new form of guide vane.**

The established and proven series with adjustable blades has been extended by the AMD / AMW Ø 225 – 400 mm with voltage-controllable 1 phase and 3 phase motors and fixed pitch angle.

The new optimally coordinated system, consisting of a polymer impeller with perfectly integrated flow geometry, an innovative guide vane with maximum pressure recovery and specially tuned motors, ensures maximum efficiency.

ENERGY-EFFICIENT ROOF FANS



**Vertical, horizontal and
diagonal discharge.**

The new roof fan range from Helios provides the optimal solution for every application.

Air flow rate capacity from 460 to 26 500 m³/h, motor inside or outside the airflow, horizontal, diagonal or vertical air discharge.

In metal or polymer casing, for air flow temperatures of up to +70 °C, +120 °C and in temperature class F400 (120 min.) according to DIN 12101-3.

EC range
overview

1

180^{on}

437^{on}

air technology. Expertise for tomorrow.

As a leader in the field of ventilation technology, we offer you expertise in the form of a modular range of workshops and technical seminars. It takes into account the current extensive changes to the standards and statutory framework, as well as the increased requirements on the planning and design of technical ventilation systems.

In addition to delivering a theoretical background, providing answers to practical and application-related issues is the top priority of our training events. Workshops designed specifically for professional tradesmen, amongst others, take place in specially developed assembly spaces. As an example, helpful tips and tricks for practical work in designing, installing and commissioning KWL® ventilation systems with heat recovery are provided using realistic situations.



At the "LCC" Ventilation Competence Centre, you will find out everything you need to know in the field of ventilation technology. Regardless of whether you want to get to know future-oriented solutions or training on subjects such as ventilation with heat recovery.

Take advantage of ventilation expertise both in theory and in practice. Pleasant surroundings, the latest media technology and a quickly assembled showroom await you.



Comfortable climate Helios.

Ventilation and air drive every facet of our passion. Passion that has moved us, spurred us on and fascinated us for decades. Visions that once inspired us have since been established optimally as market-leading products.

**AIR.
OUR PASSION.**



PURE.



QUIET.

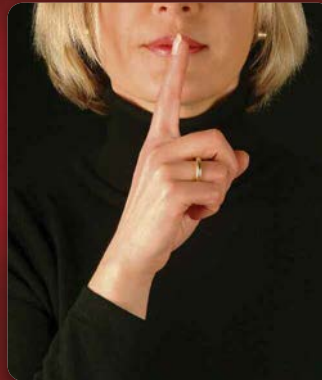

TAILORED.



As one of the leading manufacturers of fans and ventilation systems, Helios repeatedly sets ground-breaking milestones. The product portfolio offers customized solutions tailored to the respective requirements in terms of ventilation technology.

The origin of the company Helios Ventilatoren goes back to the foundation of Fernwellen Apparatebau AG in Schwenningen a.N. in 1923. The company manufactured headphones and loudspeakers with horns, as well as detector elements and had 30 employees within a short space of time.

In the early 1930s, production started on bicycle lights (dynamos, headlamps and rear lights), which were successfully marketed under the brand name "Helios" – taking its roots from the god of the sun from Greek mythology.

In 1951 the company started production of fans. In the beginning, table, ceiling and standing fans are manufactured. As early as the early 1960s, the Helios range includes axial fans in three model ranges with an impeller with a diameter of 200 to 950 mm. The following decades are shaped by successful and continuous additions to the core areas.

The required extract or intake air volume of a room depends on the use and the contamination or odours that are created within it. The air volume can also be determined by the generated process heat in industrial and commercial facilities.

The air flow volume can be calculated using various criteria with the following equations and tables. In some cases, several ways of calculating should be used and the higher figure taken.

■ Calculation of air flow volume using air change rate

Air change rates (see table 1) are based on past experience and do not take into account special pollutants.

$$\dot{V} = V_R \cdot LW/h \text{ [m}^3\text{/h]}$$

V_R : Room volume m³
 LW : Air change 1/h from table 1

■ Calculation of air flow volume using the number of people in a room

(DIN 1946-2, Stand 01.1994)
In rooms with additional pollutants (e. g. tobacco smoke) the air flow per person has to be increased by 20 m³/h.

$$\dot{V} = P \cdot A_{RP} \text{ [m}^3\text{/h]}$$

P : Number of people
 A_{RP} : Air change rate per person (from table 2)

■ Calculation of air flow volume using maximum pollutant concentration levels.

$$\dot{V} = \frac{M}{k_{AGW} - k_a} \text{ [m}^3\text{/h]}$$

M : Hourly absorption of toxic agent mg/h
 k_{AGW} : Max. permitted toxic agent concentration mg/m³ (see AGW-table 3)
 k_a : Concentration of toxins in supply air mg/m³ (AGW-table v. C. Hermanns Verlag, Cologne)

■ Calculation of air flow volume using the amount of humidity

$$\dot{V} = \frac{G}{(x_2 - x_1) \cdot \rho} \text{ [m}^3\text{/h]}$$

G : Amount of water g/h
 x_2 : Water content of extracted air g water / kg air
 x_1 : Water content of supply air g water / kg air
 ρ : Air density kg/m³ (air 20 °C, 1013 mbar = 1.2 kg/m³)

■ Calculation of air flow volume using the heat to be extracted

$$\dot{V} = \frac{\dot{Q} \cdot 3600}{\rho \cdot c_p \cdot \Delta T} \text{ [m}^3\text{/h]}$$

\dot{Q} : Required heat extraction kW
 c_p : Specific heat capacity of air kJ/(kg · K) (air 20 °C; $c_p \approx 1$)
 ΔT : Temperature difference between intake and extract air K
 ρ : Air density kg/m³ (air 20 °C, 1013 mbar = 1.2 kg/m³ (1 kWh = 3600 kJ))

■ Calculation of required heat to temper intake air

$$\dot{Q}_L = \frac{\dot{V} \cdot \rho \cdot c_p \cdot \Delta T}{3600} \text{ [kW]}$$

\dot{Q}_L : Heater output kW
 \dot{V} : Air flow volume m³/h
 ρ : Air density 1.2 kg/m³ (20 °C)
 c_p : Spec. heat capacity kJ/(kg · K)
 ΔT : Temperature difference (K) between ϑ_i room temperature and ϑ_a outdoor temperature

$$\Delta T = \vartheta_i - \vartheta_a \text{ [K]}$$

Table 1 Air change and sound pressure (recommended levels)

Room type	LW/h	max. sound pressure level dB(A)	Remark
Assembly halls	4 – 8	60 – 70	
Assembly rooms	5 – 10	45	
Bathrooms	5 – 7	45	Pre-heated intake air
Battery rooms	5 – 10	70	"Ex" required
Breweries	5 – 15	70	Acid protection
Changing rooms	6 – 8	60	Extract
Cinemas and theatres	5 – 8	35 / 25	Intake and extract
Classrooms	5 – 7	40	
Conference rooms	6 – 8	45	
Dressing rooms	4 – 6	50	
Dye rooms	5 – 15	70	"Ex" check, Acid protection
Foundries	8 – 15	80	Extract, energy balance
Garages	approx. 5	70	Extract
Gymnasiums	4 – 6	50	
Hardening shops	up to 80	80	Extract, energy balance
Kitchens private	15 – 25	45 – 50	Extract
commercial	15 – 30	50 – 60	Extract
Laboratories	8 – 15	60	Extract, Ex, Acid protection
Laundrettes	10 – 20	60 – 70	Energy balance
Lecture halls	6 – 8	35 – 40	Intake and extract
Libraries	4 – 5	35 – 40	
Machine halls	10 – 40	60 – 80	Energy balance
Meeting rooms	6 – 8	40	
Offices	4 – 8	45	
Paint rooms	25 – 50	70	"Ex" required
Photographic printing	10 – 15	60	Extract
Restaurants, casinos	8 – 12	40 – 55	Intake and extract
Salesrooms	4 – 8	50 – 60	
Sheet metal works	8 – 12	60	Extract, energy balance
Shower rooms	15 – 25	65 – 70	Pre-heated intake air
Spraying rooms	10 – 20	70	"Ex" required
Swimming pools	3 – 4	50	Pre-heated intake air
Toilets - Domestic	4 – 5	40	Extract
-commercial/public	5 – 15	50	Extract
Vaults	3 – 6	60	
Waiting rooms	4 – 6	45	
Welding shops	20 – 30	70 – 80	Spot extract systems
Workshops			
with high pollution	10 – 20	60 – 70	
with low pollution	3 – 6	60 – 70	

Living spaces pursuant to DIN 1946-6 – 05/2009 and DIN 18017-3 (see also www.KWLeasyPlan.de)

Table 2 Air exchange rate per person and room type

Room type	m ³ h x persons	Room type	m ³ h x persons
Auditoriums	30	Gymnasiums with spectators	30
Ballrooms	30	Museums	30
Break rooms	30	Offices (open plan)	60
Canteens	30	Offices (small)	40
Cinemas	30	Reading rooms	20
Classrooms	30	Restaurants	40
Conference rooms	20	Rest rooms	30
Exhibition halls	30	Shops	20
Hotel rooms	40	Theatres, concert halls	20

Table 3 Extract from occupational exposure limit table*

Toxic	cm ³ m ³	mg m ³	Toxic	cm ³ m ³	mg m ³
Acetone	1000	2400	Hydrazine	0,1	0,13
Aniline	2	8	Iodine	0,1	1
Ammonia	50	35	Methanol	200	260
Butane	1000	2350	Ozone	0,1	0,2
Chloride	0,5	1,5	Propane	1000	1800
Chromate	—	0,1	PVC	3	8
Carbon monox.	30	33	Quicksilver	0,01	0,1
CO ₂	5000	9000	Nitric acid	10	25
Formaldehyde	0,1	1,2	SO ₂ (H ₂ SO ₄)	2 (-)	5 (1)
Hydro chloride	5	7	Zinc oxide	—	5

* TRGS 900 (see quarterly lists from the Institute for Occupational Safety BGIA, Sankt Augustin)

The noise level of a fan must be taken into consideration when designing a ventilation system. The effect of a sound source (fan) on the rooms that need ventilation and the neighbourhood can be estimated using the following information:

The noise is primarily created by the fan, possibly also by ducting, and other components like filters, heaters, shutters etc. If the air flow speed is too high this will result in whistling noises. A maximum air flow speed of 7 m/s is recommended and at the same time noise transmission by fan or other components must be reduced as much as possible when installing. The maximum noise emission recommendations should not be exceeded.

Reduction in noise can be achieved by installing the noise source as far away as possible from inhabited area or by use of attenuators. Generally the noise level should be kept as low as possible at its source, that means selecting low noise fans.

Room absorption (Figure 8)

Each room has a specific attenuation characteristic.

It depends on the state of the walls, floor, ceiling, furniture and of course the size.

The sound pressure level L_{PA} is different at each position of a room. The figure is always lower than the sound power level L_{WA} of the noise source.

With room size and average absorption coefficient the average room absorption can be calculated (in m^2 Sabine).

Directivity factor Q

The directivity factor takes into account at what position the noise source and the listener are with in a room.

Noise angle 45° , $Q = 4$

Noise angle 0° , $Q = 8$

Room attenuation ΔL

Is the difference between sound power and sound pressure level (VDI 2081).

$$\text{Sound pressure level in room } L_{PA} = L_{WA} - \Delta L \text{ [dB]}$$

Example classroom

Room volume: $72 m^3$

average absorption coefficient: 0.1α

average absorption area: Sabine $14 m^2$

Room position 1, grille in middle of room

Noise angle 0° , $Q = 8$

Distance $1.8 m$

$\Delta L = 2.5 \text{ (dB)}$

Room position 2, grille in room corner

Noise angle 45° , $Q = 4$

Distance $4 m$

$\Delta L = 5 \text{ (dB)}$

To adapt a sound power level figure to what the human ear hears it can be converted into a sound pressure level. Stated with spherical sound level propagation (freefield conditions) the reduction can be calculated in relation to the distance from the noise source (figure 4). For an exact noise figure within a room the absorption capacity of the room is of much higher importance.

Sound emission levels affecting the neighbourhood

The following recommended sound levels for neighbourhoods should not be exceeded.

Area	Emission dB(A)	
	day	night
Industrial (100%)	70	70
Industrial (mainly)	65	50
Industrial/residential	60	45
Residential (mainly)	55	40
Residential (100%)	50	35
Hospitals etc.	45	35

Noise levels for working environments

The following recommended sound levels should not be exceeded permanently:

Activity	dB(A)
Intellectual concentration	55
Computer and office work	70
Other areas	85
(Maximum deviation 5 dB)	
Break, first-aid, stand-by and recovery rooms	55

Figure 4
Diff. between sound power and pressure level at a distance

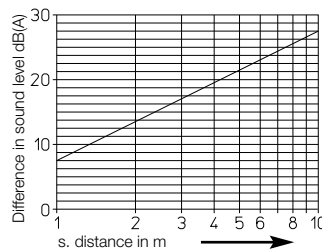

Example:
Sound power level of fan = 70 dB(A)
Sound pressure level at 1 m (freefield cond.) = 70 dB(A) less 8 = 62 dB(A)

Figure 5
Sound pressure level drop in relation to distance

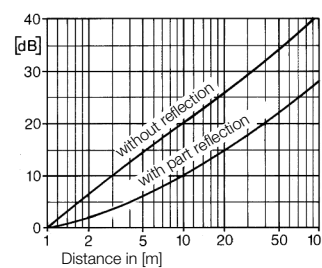

Example:
Sound pressure level at 1 m = 60 dB(A)
Sound pressure level in 5 m distance without reflection (freefield): less 15 = 45 dB(A)
with part reflection: less 5 = 55 dB(A)

Figure 6
Addition of several noise sources of equal intensity

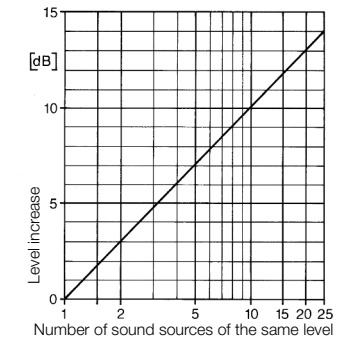

Example: 10 noise sources of 60 dB(A)
Total noise level: 60 dB(A) + 10 dB = 70 dB(A)

Figure 7
Addition of several noise sources with different intensity

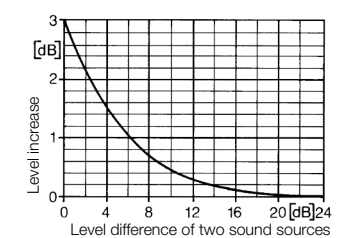

Example: 2 noise sources with 60 dB(A) and 64 dB(A)
Total noise level: 64 dB(A) + 1.5 dB = 65.5 dB(A)

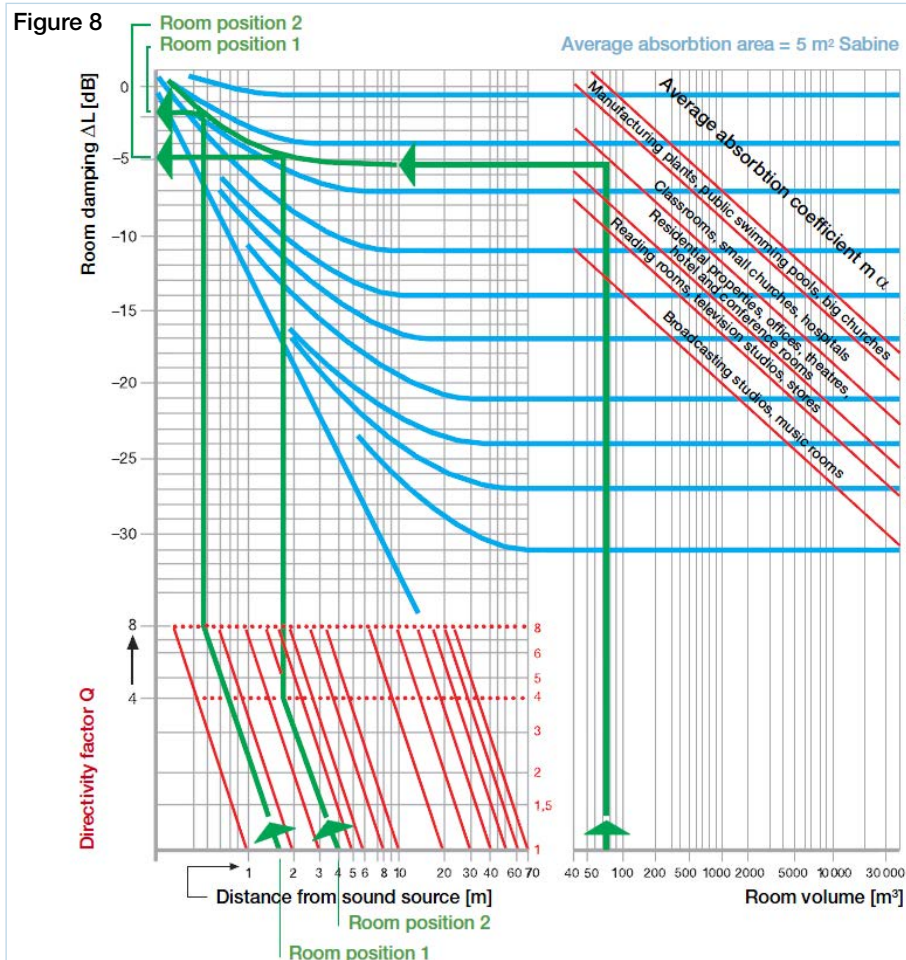

Pressure losses

Ventilation systems consist of various different components such as: fans, bends, grilles, heat exchangers, filters, etc. All these components cause pressure losses, which needs to be considered when selecting a suitable fan. The pressure loss Δp_{fa} (static pressure difference) of the total system is calculated by adding all individual resistances (see Fig. 9).

Fig. 9 Pressure losses in a ventilation system

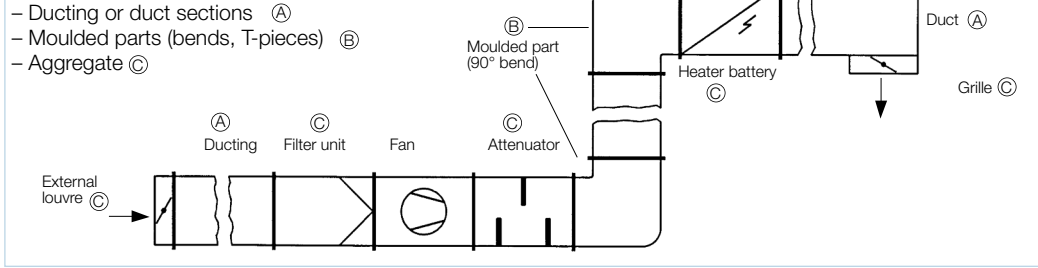

■ Pressure loss in circular or rectangular ducting

A $\Sigma \Delta p = \Delta p_1/L \cdot L_1 + \Delta p_2/L \cdot L_2 + \dots$ [Pa]

$\Delta p_{L1,2,\dots}$: From diagram Fig. 10 [Pa/m]
L: Ducting length [m]
Equivalent diameter d_h

Equivalent diameter d_h

$$d_h = \frac{2 \cdot b \cdot h}{b + h} \text{ [mm]}$$

b: Ducting width [mm]
h: Ducting height [mm]
Equivalent diameter d_h

d_h for rectangular fans

b x h [cm]	d_h [mm]
30 x 15	200
40 x 20	260
50 x 25	330
60 x 30	375
60 x 35	400
70 x 40	500
80 x 50	600
100 x 50	650

Correction factor for roughness ϵ

$\Delta p_R = \Delta p_{\epsilon=0} \cdot \text{Corr. factor}$

■ Pressure loss in moulded parts e.g. bends, T-pieces, cross-section changes

B $\Sigma \Delta p_F = \Delta p_{F1} + \Delta p_{F2} + \dots$ [Pa]

$\Delta p_F = \zeta \cdot \frac{\rho}{2} \cdot c^2$ [Pa]

$\Delta p_{F1,2,\dots}$: From diagrams Figs.12-15 [Pa]
Equivalent diameter c: air flow velocity [m/s]
 ζ : Pressure loss coefficient

■ Aggregate resistance

C $\Sigma P_{Agg} = \Delta p_{Agg1} + \Delta p_{Agg2} + \dots$ [Pa]

$\Delta p_{Agg1,2,\dots}$: From table 11 or diagram

■ Dynamic pressure at discharge opening

D $\Delta p_d = \frac{\rho}{2} \cdot c^2$ [Pa]

ρ : Air density [kg/m³]
(Air 20 °C, 1013 mbar = 1.2 kg/m³)
c: Air flow velocity [m/s]

Fig. 10 Pipe friction losses Δp [Pa/m] (roughness $\epsilon = 0$)
 \dot{V} [m³/h], c [m/s], d [mm]

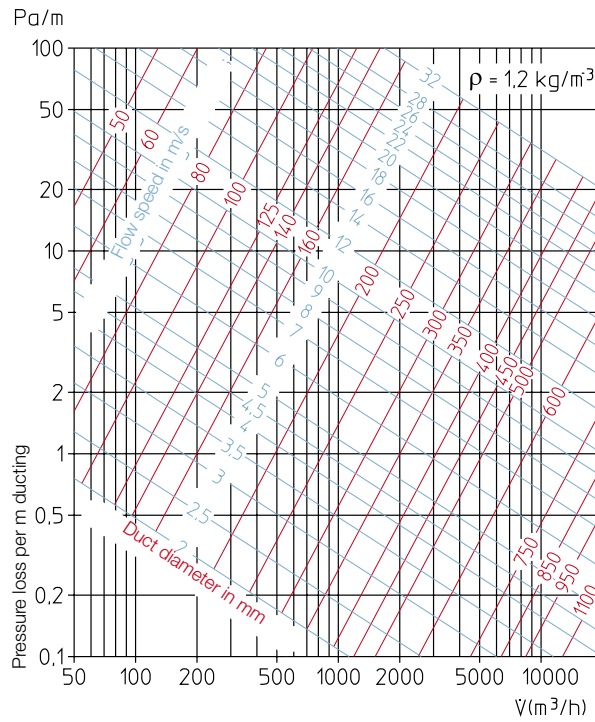

Correction factor for roughness ϵ different ducting

Folded sheet metal ducting	1.5	Wooden ducting	1.5
Flexible ducting	7.0	Concrete ducting	2.0
Fibre cement	1.5	Bricked ducting	3.0

Table 11 Aggregate resistance

(as a calculation guide)

Aggregate/Component	Resistance Δp Aggregate [Pa]
Ventilation grille, gravity shutters, external louvres*	20 – 40
Helios VK shutters*	10 – 20
Heater batteries, heat exchangers*	100 – 150
Filter clean*	40 – 60
dirty	250 – 300
Attenuators*	40 – 80
Valves*	10 – 200
Cyclone	500 – 750

*see product page for more accurate figures

■ Total resistance calculation process

$\Delta p_{ges} = \text{A} + \text{B} + \text{C} + \text{D}$ [Pa]

■ Auxiliary parameters Air flow velocity

$c = \frac{\dot{V}}{A \cdot 3600}$ [m/s]

A: Air flow area [m²]
 \dot{V} : Air flow volume [m³/h]

Moulded part resistance

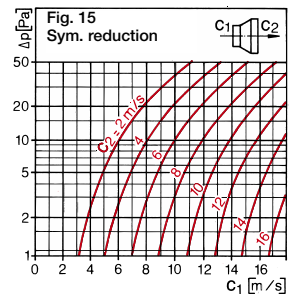
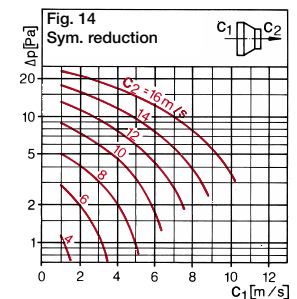
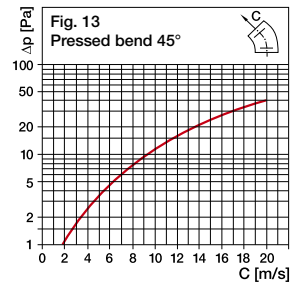
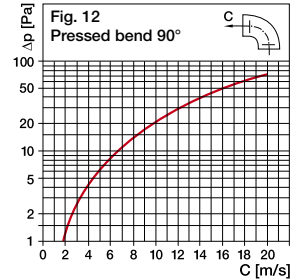

Fan parameters

Air flow volume \dot{V} [m³/h, m³/s]
 Total pressure increase $\Delta p_{tot} = \Delta p_{fa} + \Delta p_d$ [Pa]
 static pressure increase $\Delta p_{fa} = \Delta p_{tot} - p_d$ [Pa]
 dynamic pressure $p_d = \rho/2 \cdot c^2$ [Pa]
 Shaft power P_w [W, kW]
 Nominal motor power P [W, kW]
 Sound power/pressure level L_{WA}, L_{PA} [dB(A)]

All figures were measured on a test chamber stand to DIN 24163 Pt. 2. The noise figures in the acoustic chamber or in free field conditions correspond to DIN 45635, Pt.1 and 2.

Performance curves

The operational characteristics of a fan are shown in form of a performance curve. In a performance curve the air flow volume is given in relation to a static pressure (Δp_{fa}) or total pressure (Δp_{tot}). The operating point BP is the point at which the system curve meets the fan performance curve (Δp_{fa}). The air flow volume can be determined from the horizontal axis.

System curve

The pressure of a system changes as a square of the changing air flow volume.

System parabola

$$\Delta p = k \cdot \dot{V}^2$$

For consideration when selecting:

$$\Delta p_{fa} = \Delta p_{tot} - p_d \text{ [Pa]}$$

The static pressure difference is the pressure loss (Δp_{fa}) of the system (pipe friction, moulded parts, aggregates).

Fig. 16: In the performance curve of speed controllable high performance axial fans and VAR types, the performance for 1 ph. (green) and 3 ph. fans (blue) are shown. The static pressure can be read off. Line @ shows the airflow velocity through the fan at a certain air flow volume. The operating point (BP) is where the fan curve meets the system curve.

Fig. 17: The performance curve of a speed controllable fan shows the performance curves for the various speed steps (transformer voltages).

Fig. 18: For AVD above \varnothing 710, the air flow volume and the static pressure can be adjusted by changing the pitch angle of the impeller blades (adjustment of individual blades at standstill) to the calculated operating point.

Fig. 19: The performance-oriented characteristic curve diagram for the AMD series allows the adjustment of the motor power to the respective project requirements.

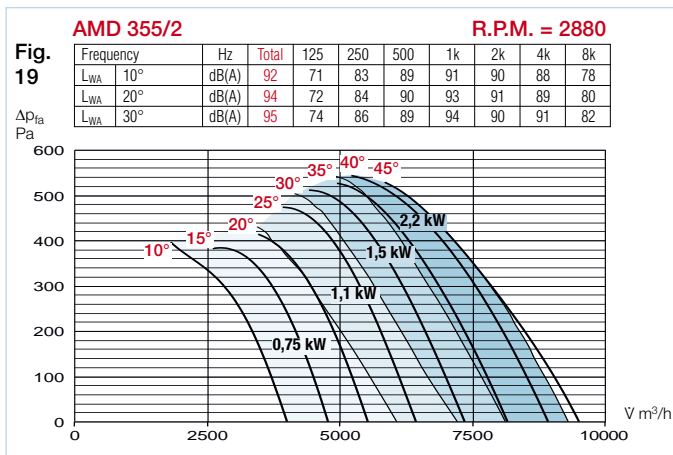
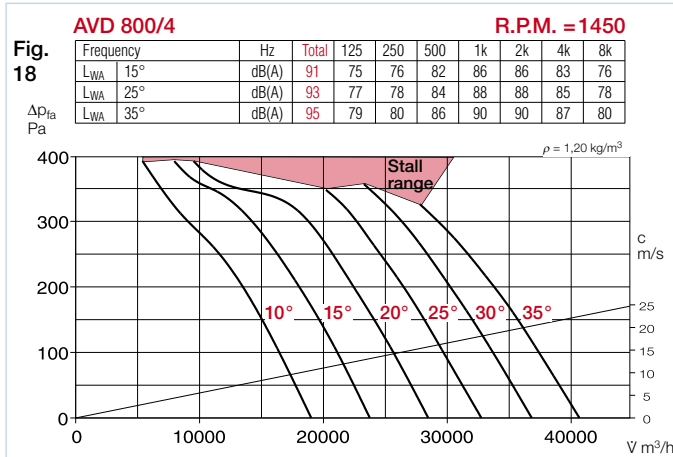
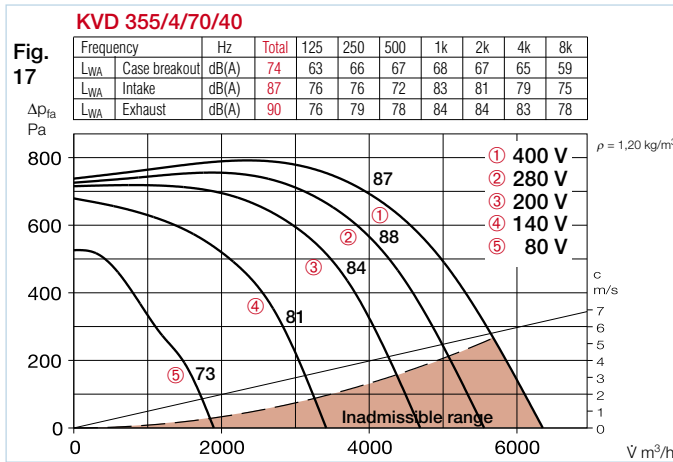
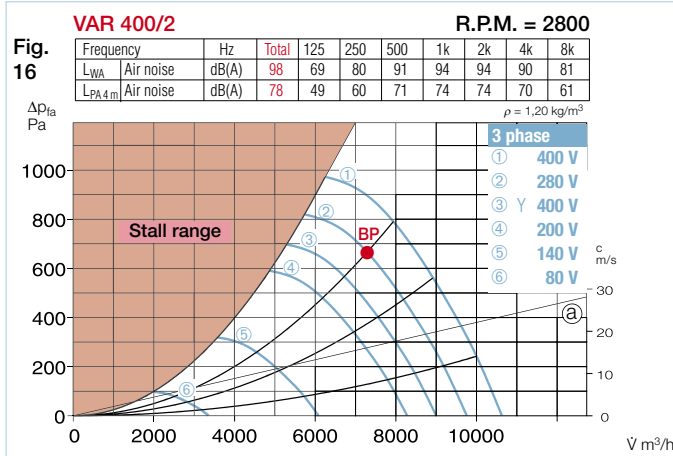

Calculation of the required shaft power of a fan

$$P_{W1} = \frac{\dot{V} \cdot \Delta p_{tot}}{1000 \cdot \eta} \text{ [kW]}$$

Δp_{tot} = Total pressure increase [Pa]
 η = Fan efficiency
 \dot{V} = [m³/s]

When using a pole-switching motor

Pole figure	Air flow volume	Pressure	Power
n_1/n_2	$\frac{\dot{V}_2}{\dot{V}_1}$	$\frac{\Delta p_2}{\Delta p_1}$	$\frac{P_{W2}}{P_{W1}}$
4/2	2	4	8
8/4			
12/6			
6/4	1,5	2,25	3,38
8/6	1,33	1,78	2,37

Conversions, affinity labels

The performance data of a geometrically similar fan series can be converted in relation to speed, diameter and air density.

Speed change:

$$\dot{V}_2 = \dot{V}_1 \cdot \frac{n_2}{n_1}; \Delta p_2 = \Delta p_1 \left(\frac{n_2}{n_1}\right)^2;$$

$$P_{W2} = P_{W1} \left(\frac{n_2}{n_1}\right)^3$$

Diameter change:

$$\dot{V}_2 = \dot{V}_1 \cdot \left(\frac{D_2}{D_1}\right)^3; \Delta p_2 = \Delta p_1 \left(\frac{D_2}{D_1}\right)^2;$$

$$P_{W2} = P_{W1} \left(\frac{D_2}{D_1}\right)^5$$

Density, temperature change:

$$\dot{V}_1 = \dot{V}_2 = const.$$

$$\frac{\Delta p_2}{\Delta p_1} = \frac{\rho_2}{\rho_1} = \frac{T_1}{T_2}$$

$$\Delta p_2 = \Delta p_1 \frac{\rho_2}{\rho_1} = \Delta p_1 \cdot \frac{T_1}{T_2} \text{ [Pa]}$$

$$P_{W2} = P_{W1} \frac{\rho_2}{\rho_1} = P_{W1} \frac{T_1}{T_2} \text{ [kW]}$$

T: Absolute temperature (T = 273+ t) [K]
 t: Air flow temperature [°C]

Index 1: Original condition

Index 2: Modified condition

Use of a fan at different altitudes air density

$$\rho = \frac{p_a \text{ [hPa]} \cdot 100}{R_i \cdot T} \text{ [kg/m}^3\text{]}$$

p_a : Air pressure [hPa, mbar]
 R_i : Gas constant (Air: 287 J/(kgK))

■ Explosion protection according to Directive 2014/34/EU (ATEX)

□ Helios explosion proof fans for operation in or to move potentially hazardous atmospheres or substances must be in accordance with Directive 2014/34/EU (ATEX).

□ For that purpose the fans are classified according to ④.

■ Zone definition, Product group, Product categories ①

□ Zone definition

Explosion proof zones will normally be determined according to the implementation of the 94/92/EC and industrial safety regulation. The definition of the zones is to be determined by the operator and is his responsibility. If in doubt or for special applications, the local authorities should be consulted. Different zones have been allocated to take into account of the different degrees of risk from the concentration of flammable gas or vapour that may arise in an installation. It considers the frequency and duration of the hazardous atmosphere on each occasion.

□ Product groups

Product group I: Products for use in the underground part of mines and those parts of surface installations of such mines those are likely to become endangered by firedamp and/or combustible dust.

Product group II: For use in other places likely to become hazardous by explosive atmospheres.

□ Product categories

1 – Very high level of protection.
2 – High level of protection.
3 – Normal level of protection.
The explosive atmospheres are either Gas vapour (G) or Dust (D) and need one of the following categories of protection.

□ Helios explosion proof fans are suitable for product II category 2G or 3G (see product specific information) for operation in zone 1 and 2 and fulfil with professional installation the fundamental safety and health requirements.

□ All certified information is stated on motor type plate. Also the tripping period t_E for the motor protection unit according to DIN EN 60079-0 / VDE 0170 / 0171 or DIN EN 60079-10 / VDE 0165-101.

□ When connecting, all relevant safety and installation regulations must be observed.

□ Special execution, abnormal voltages, protection to class “d” (flameproof enclosure) are possible on request.

□ For some types a vibration monitoring is to be carried out according to DIN EN 14986 (see resp. product catalogue age).

■ Types of protection ②

□ Classification:

- “e” – Increased safety
- “d” – Pressure-tight enclosure
- “de” – Pressure-tight enclosure with subgroup “e”

“c” – Constructional safety
For Vfan motors with terminal boxes ignition protection type “e” is normally applied as a subgroup.

□ Explosion group ②

additionally divided into I = firedamp protection or II = explosion protection. The explosion groups are divided into IIA, IIB and IIC. The hazard level of gases increases from IIA to IIC. Thus, If an apparatus is suitable for group IIB it can automatically be used for group IIA. According to EN 14986, fans can only be used with gases from explosion groups IIA and IIB (except Hydrogen H2 from explosion group IIC, provided IIB+H2 is marked on the fan type plate).

■ Ignition-, surface temperature and temperature classes ②, ③

□ The ignition temp. ③, i.e. the temperature at which an ignition may occur e.g. through contact with a hot motor surface, depends on the nature of the gases and steams. The maximum surface temperature of an electrical appliance must always be lower than the ignition temperature of the substance used (DIN EN 60079-0 or DIN EN 60079-10).

□ In order to simply label and select electrical equipment in product group II with regard to their max. surface temperatures, distinctions are made between several temperature classes. Accordingly, the gases can be assigned to these classes based on their ignition temperatures. Apparatus with a higher temperature (e.g. T5) can also be used for substances classified with a lower class (e.g. T2 or T3).

□ The temperature class, the maximum surface temperatures and ignition temperatures are given in tables ②, ③.

□ The temperature class of each fan is stated on the individual catalogue page; binding specifications can be found on the motor type plate.

■ Operation

□ Explosion-proof motors (protection “e” increased safety) do not have thermal contacts. The Ex-proof rectangular, roof, high-performance axial and VAR fans with larger outputs are fitted with PTC thermistors.

① Zone allocation, product groups and categories

Flammable substances	Zone to DIN EN 60079-10	Descriptions	Product group	Product category
Gases, vapour, mist	Zone 0	Zone in which an explosive atmosphere is continuously present, or present for long periods.	II	1G
	Zone 1	Zone in which an explosive atmosphere is likely to occur in normal operation.	II	1G or 2G
	Zone 2	Zone in which an explosive atmosphere is not likely to occur in normal operation, and if it occurs it will exist only for a short time	II	3G, 2G or 1G
Dust	Zone 20	Zone in which an explosive atmosphere is continuously present, or present for long periods.	II	1D
	Zone 21	Zone in which an explosive atmosphere is likely to occur for a short period due to the presence of dust in the atmosphere.	II	2D or 1D
	Zone 22	Zone in which an explosive atmosphere in the form of a cloud of combustible dust in the air is not likely to occur in normal operation and if it occurs it will exist only for a short time.	II	3D

**② Safety-related figures for flammable gases and vapours
Ignition temperature, temperature class, explosion group**

Flammable material	Ignition temperature °C	Temperature class				Explosion group		
		T 1	T 2	T 3	T 4	II A	II B	II C
Acetaldehyde	155				T 4	II A		
Acetone	535					II A		II C
Acetylene	305		T 2					
Ethane	515	T 1				II A		
Ethyl acetate	470	T 1				II A		
Ethyl aether	175				T 4		II B	
Ethyl alcohol	400		T 2				II B	
Ethyl chloride	510	T 1				II A		
Ethylene	440		T 2				II B	
Ethylene oxide	435		T 2				II B	
Ethyl glycol	235						II B	
Ammonia	630	T 1		T 3		II A		
i-Amyl acetate	380		T 2			II A		
Benzines, fuels	220 to 300			T 3		II A		
Boiling inception < 135 °C								
Special benzines	220 to 300			T 3		II A		
Boiling inception > 135 °C								
Benzene (pure)	555	T 1				II A		
n-Butane	365		T 2			II A		
n-Butyl alcohol	325		T 2			II A		II B
Cyclohexanone	430		T 2			II A		
1,2-Dichloroethane	440		T 2			II A		
Diesel fuels	220 to 300			T 3		II A		
DIN 51601/04.78								
Jet fuels	220 to 300			T 3		II A		
Acetic acid	485	T 1				II A		
Acetic anhydride	330		T 2			II A		
Heating oil EL	220 to 300			T 3		II A		
DIN 51603 Pt. 1/12.81								
Heating oil L	220 to 300			T 3		II A		
DIN 51603 Pt. 2/10.76								
Heating oil M and S	220 to 300			T 3		II A		
DIN 51603 Pt. 2/10.76								
n-Hexane	230			T 3		II A		
Carbon oxide	605	T 1				II A		
Methane	595	T 1				II A		
Methanol	440		T 2			II A		
Methyl chloride	625	T 1				II A		
Naphthalene	540	T 1				II A		
Oleic acid	250			T 3			→	
Self-disaggregation								
Phenol	595	T 1				II A		
Propane	470	T 1				II A		
n-Propyl alcohol	385		T 2				II B	
Carbon disulphide	95				T 6			II C
Hydrogen sulphide	270			T 3			II B	
Town gas (illuminating gas)	560	T 1					II B	
Tetralin	390		T 2				→	
(Tetrahydronaphthalin)								
Toluene	535	T 1				II A		
Hydrogen	560	T 1						II C

* Extract from the reference book “Sicherheitstechnische Kenngrößen”, Band 1: Brennbare Flüssigkeiten und Gase, Physikalisch-Technische Bundesanstalt, Braunschweig, von E. Brandes/W. Möller. ISBN 3-89701-745-8

→ Explosion group not identified yet for this material

③ Temperature class, surface and ignition temperature

Temp. class	Maximum surface temp. of equipment	Ignition temp. of flammable substance
T 1	450 °C	> 450 °C
T 2	300 °C	> 300 °C
T 3	200 °C	> 200 °C
T 4	135 °C	> 135 °C
T 5	100 °C	> 100 °C
T 6	85 °C	> 85 °C

④ Classification

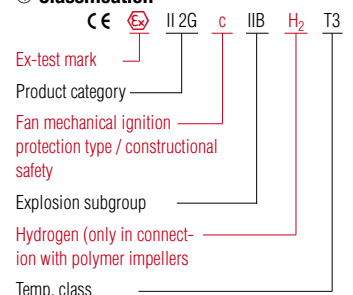

- The perfect technical solution is of highest priority for Helios. Experience and the consistent development of ideas and methods has resulted in world wide acceptance of Helios products. Research and development are reflected in an extensive product range which offers the technical solution for most applications. Helios is also your partner for custom-made products. The combination of the latest technology with the highest quality and design lead to many product advantages like:
 - Economical operation through high efficiency products. Fans and motors are perfectly tuned for each other.
 - Highest reliability even under toughest working conditions is gained by use of immersion impregnated windings, sealed for life ball bearings, quality checks etc.
 - Simple adjustment of performance through speed controllable motors using transformer or electronic speed controllers.
 - Innovative aerodynamical design of parts and components.
 - Low noise levels make Helios fans some of the most quiet available.
 - Easy installation and maintenance free operation in combination with highest electrical and mechanical safety standards are beneficial for installer and user.

■ Use and operation of fans

Factors which are individual to each installation have an influence on the fan's performance as well as the electrical and mechanical safety. Before installation/use of fan and accessories, the operation and requirements of the fan system must be clarified. The equipment must not be used for purposes for which it is not intended.

■ Motors

Fans make special demands on motors. Therefore Helios develop and manufacture many of their own motors, especially the speed controllable models. This guarantees optimal matching to the fan's needs. This results in a range of specialised drives serving the individual fan's requirement. For example, this guarantees:

- Superb speed control.
- Low power consumption.
- Low maintenance.
- Trouble free operation even under difficult conditions.
- Compliance with all relevant standards, such as DIN EN 60034 / VDE 0530 and DIN EN 60335-1 / VDE 0700.

□ Design of Helios motors

- Casing made of aluminium or cast iron, totally enclosed with cooling fins. Protection class: see individual type page.
- Bearings: maintenance free (sealed for life) and dust proof through double lip sealing. Lubrication graded from -40 to +140 °C.
- Full immersion, tropical moisture protection to windings, insulation class B.

- All other motors are manufactured to IEC standard and conform with all relevant regulations. Their specifications may vary. Different specifications are available on request.

■ Performance data

Technical data (power, noise figures, etc.) is stated in accordance with DIN 24166 Technical Conditions of Sale accuracy class 2 or 3, DIN 44974, Pt.1-3 Electrical domestic fans, DIN EN 60335-1 / VDE 0700.

□ Air performance

Pressure increases and air flow volumes are stated in performance curves on the individual product pages.

- All performance data is determined on test stands to DIN 24163, Pt. 2 and Pt. 3. **Air flow volume \dot{V} , pressure increase Δp_{fa}** in installation type A (free intake, free discharge). The **total pressure increase Δp_{tot}** is calculated with the dynamic pressure p_d from the cross-sectional area.

- Ducted fans are measured with a bell mouth on the intake and ducting of 1 diameter of the fan in length attached on the outlet. If the installation varies from this (obstructions, bends, etc.) a reduction in performance must be taken into account.

- The presented **performance curves** relate to an air density of $\rho = 1.2 \text{ kg/m}^3$ and to the given nominal R.P.M. figure. The actual speed of the individual fans may vary and are stated in the related tables. The specified air flow velocity c and the dynamic pressure p_d relate to the extract cross sectional area (casing cross sectional area).

□ Electrical data

Voltage, frequency, current, absorbed or nominal motor power, protection class and the wiring diagram number for the fan can be found in the fan's data table.

The figures relate to normal operating conditions (Density $\rho = 1.2 \text{ kg/m}^3$, Temperature $T = 20 \text{ }^\circ\text{C}$, Mains frequency 50 Hz).

The actual figures may vary depending on the installation conditions. When installing the equipment the electrical figures stated on the rating plate must be observed.

For other environmental conditions, in particular at low temperatures, an increase in the current and power figures can be expected. This needs to be considered when sizing the electrical supply (wires, contactors, circuit breakers). If in doubt consult Helios.

□ Noise levels

Noise figures are given as A rated sound power levels and/or sound pressure levels at a distance of 1 or 4 metres. The levels are illustrated in the performance curves and fan data tables.

The sound pressure levels are for freefield conditions and may be affected by reflections of walls etc. The figures relate to the details given in chapter 'performance data' and are in accordance with DIN 24166. Installation conditions may increase noise levels, in some cases substantially.

If no other references are made, the noise levels represent the air noise on the intake. All figures were measured in accordance with DIN 45635, Part 38.

The **sound pressure level** heard by the human ear from a certain distance is always lower than the sound power level and independent of the distance to the noise source and the environmental conditions.

■ Electrical connection

For each electrical item there is a wiring diagram number shown in the data table which must be used when connection is made. All relevant regulations must be observed during installation and electrical connection. The fans must be protected against overload of the motor (for each phase, e.g. if one phase fails) by a circuit breaker or via the built-in thermal contacts connected to a motor protection unit. The protection must be provided for all phases and fan speeds (pole-switching models). For selection of the circuit breaker the electrical figures stated on the motor rating plate must be used. If not it might malfunction and invalidate any guarantee claim.

HELIOS – Chamber test stand according to DIN 24163, Pt. 2

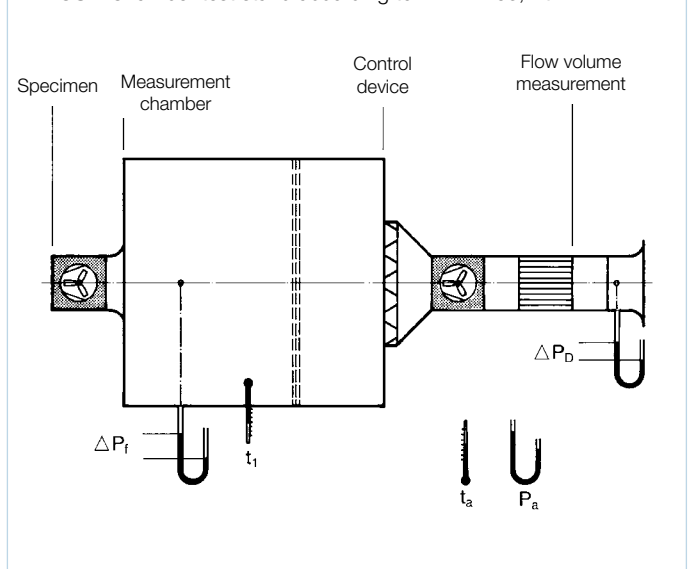

■ **Motor protection for AC motors**

All **ph. motors** are fitted with thermal contacts (TK) as standard. For some models they are wired in series with the motor windings on others they are wired to the terminal block.

The majority of **controllable 3 ph. motors** (except explosion-proof versions) have thermal contacts wired to the terminal block.

□ **Motors with thermal contacts wired to the terminal block**

must be connected to a motor protection unit (see accessories). The ports marked 'TK' have to be connected in accordance with the wiring diagram. If temperatures in the motor windings are too high (e.g. caused by bearing problems, obstructed impeller, inefficient cooling, too high air flow temperature, 2-phase connection) the thermal contact trips and the motor protection device isolates the fan from the supply. The fan must be restarted manually. If this happens frequently there is a fault in the system which must be remedied. This protection offers a full protection of the motor even if speed controlled. Most Helios 1 ph. and 3 ph. fans have built-in thermal contacts as standard (see fan data table). For other models they can be supplied as an extra.

□ **Motors with thermal contacts wired in series with the motor windings**

The majority of Helios 1 ph. fans with smaller performances have thermal contacts wired in series with the motor windings (see fan data table). They trip if the motor temperature is too high and open the electrical circuit. After having cooled down the fan will restart automatically. If thermal contacts trip this indicates a fault (e.g. stiff running, obstructions, too high air flow temperatures) which must be removed before continuing operation.

□ **Motors with built in PTC thermistors**

are used for higher performances where temperatures rise quickly (e.g. under difficult working conditions). To offer a full protection each winding should be fitted with a PTC thermistor (available at special order; as standard for explosion proof rectangular fans and RD roof fans as well as Axial and mixed-flow fans VAR with large motor powers (see product page). The thermistors are temperature sensitive elements. If a certain temperature is exceeded the electrical resistance jumps up. The thermistors must be connected to a special circuit breaker (type MSA, see accessories).

□ **Motors without thermal overload protection**

can be protected with overcurrent motor protection switches with bimetal relays. Installation in the mains supply line. This option does not offer protection for speed-controlled fans against exceedingly high air flow temperatures and potentially insufficient motor cooling. For pole-switching motors, each speed should be protected separately.

■ **Air flow temperatures**

The standard fan range is suitable for operation in ambient temperatures from -30 to at least +40 °C, or higher for a short period (except explosion proof fans).

The maximum permanent temperature for each model is stated in the fan data table or in the range of the custom product.

□ **Speed control**

Speed control causes an increase in motor temperature. The max. temperature figures stated in the fan data table should be reduced by 10 °C when using a speed controller.

■ **Flow medium**

The standard models are suitable for normally dirty, non-aggressive and normally humid air. For differing operation conditions, please consult Helios.

■ **Protection against contact**

Some fans come with a protection guard to DIN EN 60335-1 / VDE 0700 respectively DIN EN ISO 13857. Depending on the installation, additional protection may be required. The installer as well as the user is responsible to ensure that sufficient protection is given.

All safety regulations must be followed and a protection against accidental contact to DIN EN ISO 13857 guaranteed. Contact with rotating parts must be avoided. Ensure that there are not any items near the intake which could be pulled into the fan. Fans which are protected by their installation (e.g. installation in ducting or closed aggregate), do not require a guard if the system provides the required protection. We emphasise that the installer is liable for accidents due to insufficient safety measures. Suitable guards are available as accessories.

■ **Explosion protection according to Directive 2014/34/EU (ATEX)**

□ Helios Ex-proof fans are manufactured according to Directive 2014/34/EU.

□ They have EC type approval.

□ Helios explosion proof fans are designed:

- operate in explosion-proof areas.
- to move potentially hazardous gas, vapour and air mixtures.

□ The declaration of conformity according to Directive 2014/34/EU confirms the accordance of the product as well as the requirements and assessment procedures as defined in the EC Directive. It is enclosed with each unit.

□ The Helios quality control system is certified according to Directive 2014/34/EU, Annex IV.

□ The fulfil the ignition protection type "e" Increase safety. Use in zone 1 and 2. Product group II, category 2G and 3G.

□ The mechanical part is manufactured to DIN EN 14986.

□ Connection according to all relevant regulations.

□ The motor protection switch must be selected and configured according to VDE 0165, DIN EN 60079-0 and DIN EN 60079-10. The t_E time can be found on the motor type plate.

□ Speed control is only permitted for models with fitted PTC thermistors in combination with a motor protection unit MSA.

□ Depending on the selected motor brand, the electrical data can differ from data stated in the catalogue. For the selection of possible controllers the data on the motor rating plate are to be requested.

□ Special execution, abnormal voltages, protection to class "d" (flameproof enclosure) are possible on request.

■ **IP protection classes**

describes the amount of protection against solids (1st digit) and water (2nd digit):

- IP X4 – Protection against spray water from all directions.
- IP X5 – Protection against jet water from a nozzle in all directions.
- IP 4X – Protection against solid objects > 1 mm.
- IP 5X – Moderate protection against dust.

■ **Test marks – Approvals**

Helios fans have a high quality-standard and conform with national and international regulations. When correctly installed they comply with the regulations in the machinery directive and those of trade associations. Various products undergo a process of periodical testing by independent bodies like TÜV, VDE and the Forschungs- und Materialprüfungsanstalt des Landes Baden-Württemberg, Otto-Graf-Institut. All products carry at least one of the following harmonized approvals:

	VDE- and GS (approved safety) approval from VDE test centre
	SEV conformity mark, Switzerland
	Test mark of the Austrian Association of Electrotechnics
	DEMKO Safety approval of Danmarks Elektriske Materielkontrol
	SEMKO Safety approval of Svenska Elektriska Materialkontrollanstalten
	NEMKO Safety approval of Norges Elektriske Materielkontrol
	M.E.E.I. Safety approval of MAGYAR ELEKTROTECHNIKAI ELLENORZO INTEZET, Hungary
	Safety approval of STAVEBNÍHO INŽENÝRSTVI, Czech Republic
	Safety approval of DRŽAVNI ZAVOD ZA NORMIZACIJU I MJERITELJSTVO, Republic of Croatia
	Safety approval of Instytut Ukrometrestandard, Ukraine
	Safety approval of Federal Agricultural Employer's Liability Insurance Association
	Production monitoring approval of the Material Testing Institute Stuttgart University and TÜV SÜD
	Approval from the Deutsche Institut für Bautechnik
	Explosion protection pursuant to ATEX Directive
	EC – conformity mark
	Protection class IP X4
	Protection class IP X5
	Protection category II

■ **Design**

The innovative and functional product design of various Helios fans has been acknowledged with:

product design award 2008	reddot design award winner 2008	GERMAN DESIGN AWARD SPECIAL 2016

■ Performance adjustment by speed control for AC motors

The requirement to control the performance of a fan system is based on various factors.

- To increase comfort.
- To adapt the system to the changing requirements within building (number of people, air quality, temperature etc.).
- To ensure economical operation.

Controlling fans by speed controlling is the best way of adapting the performance with regards to energy consumption and noise. The required shaft power is reduced by the cube of the speeds change. If the speed is halved the shaft power drops to one eighth of the full speed figure.

$$\frac{P_L}{P_{L_0}} = \left(\frac{n}{n_0}\right)^3$$

How much of this reduced shaft power results in energy savings depends on the characteristic of the used motor and controller.

Helios motors are specially designed to match the impeller's power requirements. This guarantees optimal efficiency at full speed and when controlled.

■ Controllers

The controllers offered by Helios can control a number of fans within their rating. When selecting a controller it should be noted that in some cases using a control increases the current above the Full Load Current (see product pages). In case of doubt a 20% buffer should be given.

□ Frequency inverter

Four different frequency inverter series in "Basic", "Basic Sine", "Comfort" and "Comfort Sine" versions are available for speed-controlling 3 ph. motors. All frequency inverters are specially tuned to the features of the Helios fans. When using different brands, special fan versions may be necessary (contact Helios).

The "Basic" frequency inverter types are design for simple speed control in combination with speed-potentiometers (accessories) or speed control in combination with electronic controllers (accessories). With regard to the "Comfort" series, the operation and adjustment of control parameters takes place via the display and operating keys or, even more conveniently, via the integrated Modbus. They are equipped

with a complete controller for temperature, pressure and air velocity regulation, and the necessary sensors are available as accessories.

The frequency inverter-suitability must be specified when ordering product series without sine filters.

FU "Basic" and "Comfort" are suitable for the operation of individual fans that are suitable for frequency inverters, and the shielded cable length between the frequency inverter and fan should not exceed 10 metres. "Basic Sine" and "Comfort Sine" are suitable for the parallel operation of several fans in series design (up to max. current) and do not require additional EMC measures for customer-side wiring.

The use of different controller manufacturers may lead to functional problems as well as motor or controller defects. If such devices are used – not authorised by Helios – guarantee and warranty claims shall lapse.

- ### ■ Electronic speed controllers,
- which work on the principle of voltage reduction by cutting the phase may create electromagnetic noise (humming) in the motor at low speed which could be disturbing. For noise critical (sensitive) installations the use of a transformer is recommended.

■ Comparison of different control methods

1. Speed control
2. Reduction or bypass
3. On/off operation
4. Guide vane/rotor blade adjustm.

The opposite diagram shows the advantages of speed control in comparison to other methods used in practice.

Helios fans are speed controllable by voltage reduction, by using frequency inverters or pole-switching motors (2 speed). The suitable controller range is offered as accessories on the "MSR Measurement – Control – Regulation" pages.

■ Behaviour of important fan parameters for speed control

An additional advantage of speed control is the substantial reduction in noise levels. The sound level may be reduced by up to

$$\Delta L \approx 50 Lg\left(\frac{n}{n_0}\right) \text{dB}$$

(n_0 : nominal speed)

and therefore is ideal for operation of fan systems at night.

Example:

If the speed is halved the noise level drops by up to 15 dB.

The diagram systematically shows the relation of air flow volume, pressure loss, power and noise level when a fan is speed controlled.

■ Speed controllable types

are marked as such on the product page. Suitable speed controllers are shown in the data table. Models which don't have a controller shown must only be used at full speed.

■ Guarantee, sale conditions, warranty

The warranty period is 12 months from the date of delivery. The scope of warranty is defined in the Helios sale conditions.

Changes made to the products, interferences or non-compliance with the relevant installation and connection instructions shall release Helios from any warranty obligation.

All information in this catalogue is completely non-binding and can be changed without prior notice.

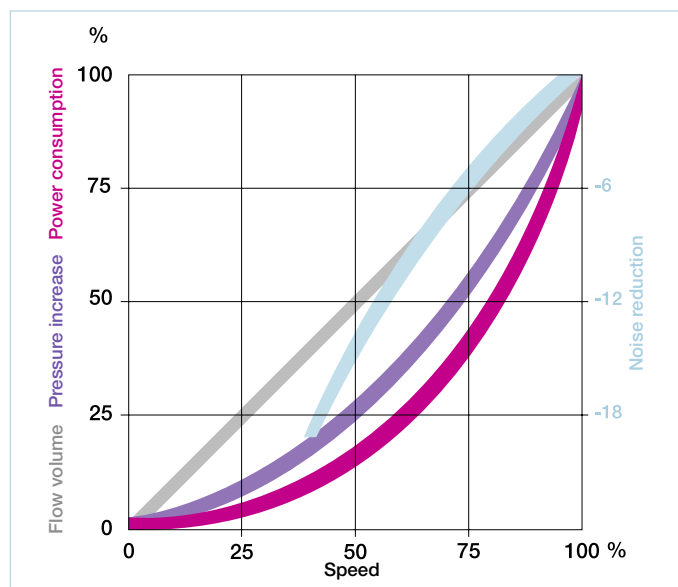
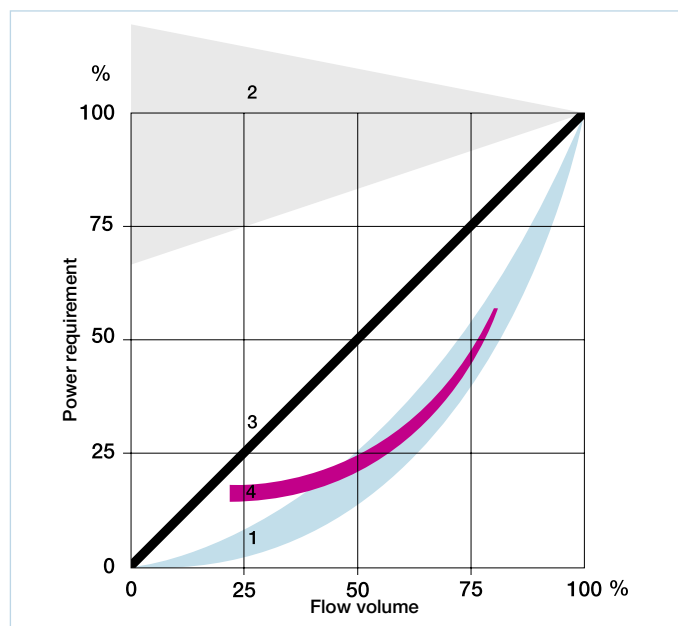



EC technology

EC motor technology is being increasingly used in fan technology as EC (electronically commutated) motors have significant advantages over AC (alternating current) motors. An AC motor runs according to its number of pole pairs and network frequency (generally 50 Hz) and the static rotating field produced from this as a factor of the slip.

Example of a 2-pole motor, 50 Hz:
50 Hz x 60 sec./pole pair
– 5 % slip
= 2850 R.P.M.

- In contrast, the EC motor is a brushless direct current motor, designed as an external rotor motor. In this type of motor, the magnetic field is generated by a ring-shaped permanent magnet in the rotor. The stator stack with the coils – unlike in the conventional collector motor – is firmly connected to the bearing cap of the motor and does not rotate. The angle of the permanent magnet in the rotor is determined by three Hall sensors and evaluated by electronics built into the motor. The electronics energise the corresponding coils depending on the angle of the rotor and the desired direction of rotation in order to generate the required torque. The entire process takes place without wear and tear and without sparking. The commutation means that there is no wear and tear in the motor, the ball bearing is the only remaining wearing part. Permanent magnets form the magnetic poles. The network frequency is of no importance here. The motor winding is intermittently supplied with energy with a defined switching frequency according to the desired maximum torque.
- This makes stepless, almost linear regulation possible over the entire range of speeds (see figure 1).

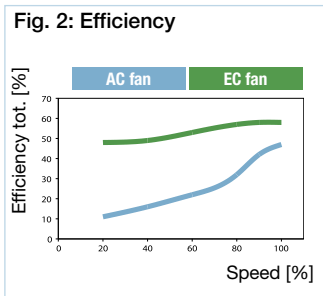
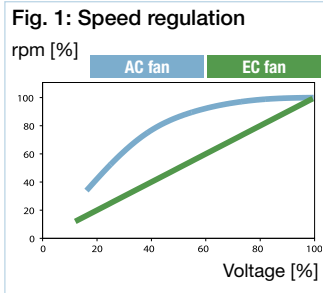

- The use of modern, energy-efficient EC motor technology produces significantly higher fan efficiency (see figure 2) as there are almost no losses caused by iron, copper and slip in the EC motor.
- In addition, EC fans work without wear and tear and therefore do not require maintenance. They are also characterised by low-noise operation. The EC motor has almost no brushing noises and runs almost silently – other than the low level of noise caused by the air conveyance. There is no more magnetising humming that interferes with AC motors during regulation. Ultimately, the EC motor is always more quiet than the comparable collector motor.

Energy savings

In ventilation technology, fans are normally designed for the worst case scenario. This means that fans are planned for the maximum anticipated capacity. However, this operating state is very rare in practice. Ventilation and air conditioning systems are generally operated based on demand. The need for ventilation is determined based on a wide range of parameters (e.g. air temperature, humidity, CO₂ content, etc.) and the required volumetric air flow is derived from this. Specifically therefore, the fans have to be reduced to partial load operation with the help of control and control devices.

- Due to its significantly higher motor efficiency, the EC fan has considerable energy benefits in comparison to its AC equivalent even in full load operation. These become even more apparent in partial load performance. Although the motor losses remain almost equal in the EC motor even at lower speeds, the losses with the AC motor rise considerably at lower speeds.

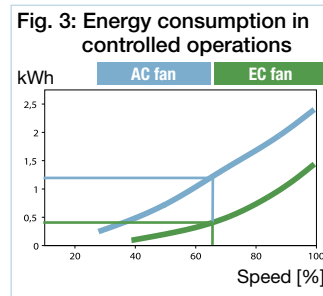

- In this specific application, the EC motor has considerable potential to save energy and therefore operating costs given its considerably improved partial load performance.
- Thanks to the energy-efficient EC technology, energy savings of over 50% in comparison to conventional AC technology can be achieved in operations where the speed is regulated (see figure 3). When considering the bigger picture, it must also be taken into account that the necessary regulation and control devices have a significantly lower investment cost than with EC technology.

Controllability / partial load performance

- The benefits of EC technology are significantly more apparent in partial load operation. Whereas standard AC motors can be controlled by tapped transformers or phase angle control in partial load operations, the regulating components are already integrated in commutation electronics with EC motors. This means that only a 0-10 V control signal (speed potentiometer) is required for speed control.
- The electronics already integrated in the motor also enable regulation variations other than constant pressure or volumetric flow regulation. Cost-effective universal control devices are available for this. Whereas the EC motor

has an impressive, almost proportional characteristic, % voltage = % speed, the AC motor is significantly less advantageous. AC motors have improved regulation thanks to so-called "softening". A "soft AC motor" can be understood as a synonym for a motor with high slip (speed difference between stator and rotor). However, a reduction of the motor efficiency must be accepted in return for the optimised controllability.

- Benefits of EC technology**
- Maximum efficiency, particularly in controlled operations.
- Up to 30% energy savings in full load operation and over 50% in partial load operation.
- Exceeds the requirements of the 2015 ErP Directive.
- Short amortisation.
- Stepless, almost linear control behaviour.
- Simple, cost-effective regulation through the speed potentiometer.
- Integrated regulation electronics (0-10 V signal) saves high-loss, expensive solutions such as transformers or phase angle control.
- Integrated electronic temperature monitoring.
- Low-noise, smooth operation without humming from magnetisation.
- Can be used universally within the 200-270 V power supply range and in 50 Hz and 60 Hz networks.

■ Characteristic curve display

The EC fan is regulated steplessly with the aid of a simple potentiometer or seamless speed control with a universal control system. For example, the characteristic curve shows performance levels as a factor of control voltage (e.g. 2, 4, 6, 8, 10 V). Given the seamless controllability, any operating point within the characteristic curve is conceivable. The speed (n), power consumption (P), current consumption (A), noise level (Lp) and specific fan performance (SFP) are stated in tabular form beneath each EC characteristic for the free blowing (no system resistance) operating state (excluding high-performance axial fans) for the respective sample control voltage. The maximum voltage and the maximum power consumption are stated for high-performance axial fans.

■ Efficiency analysis

Ventilation devices with an AC motor have a cost advantage in terms of investment costs, however, this only relates to the fan. As soon as the normal speed regulation required is included in the considerations, the supposed benefit balances itself out rapidly:

- The speed of AC motors is often regulated by high-cost transformer speed controller or frequency inverters.
- In contrast, in EC fans, the network voltage is directly connected to the motor on-site and converted to a corresponding DC voltage by the electronics integrated in the motor. Only one control signal (0-10 V) is required from the setpoint generator to regulate the speed. Therefore, price-effective potentiometers are used as field devices.

□ Now if you compare the total costs of all required components for investment in ventilation technology, these not only even out, but often the cost benefit lies with the EC technology.

□ Given its benefits in terms of efficiency, the EC motor is suitable for full load operation and primarily in partial load operation primarily for installations with long operating times and changing operating states.

□ The following example of the H-series clarifies the operating cost benefits in comparison to EC technology (see table 1: Efficiency analysis).

Figures 1 and 2 show the electrical power consumption for the free blowing operations. Figure 1 full load operation (1400 min⁻¹). Figure 2 shows the partial load operation (700 min⁻¹).

The X-axis shows the speed. The Y-axis on the left shows the power consumption in Watts. The Y-axis on the right shows the benefits of EC over AC in Euro/year given the corresponding partial load and the stated framework conditions.

Characteristic curve GBD EC 560

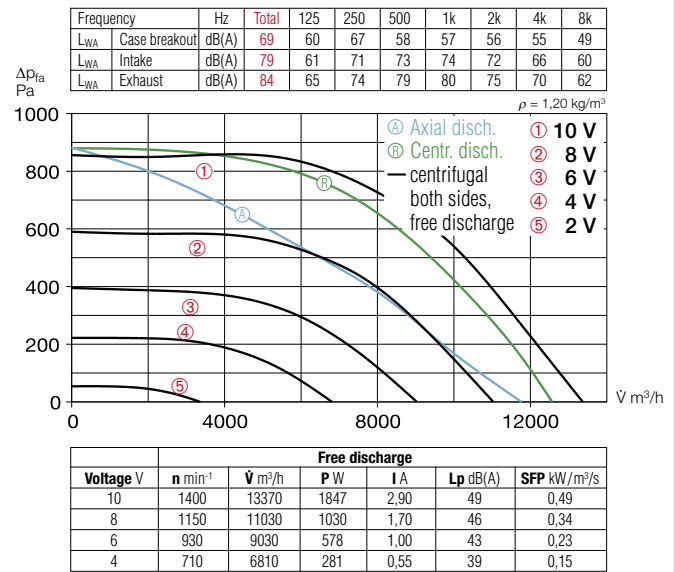

Fig. 1: Full load operation

Calculation based on following framework conditions:
Conveyor cap. free discharge. Operation 4 h/day, 365 days/year = 1460 h/year
Electricity price 0.24 Euro/KWh

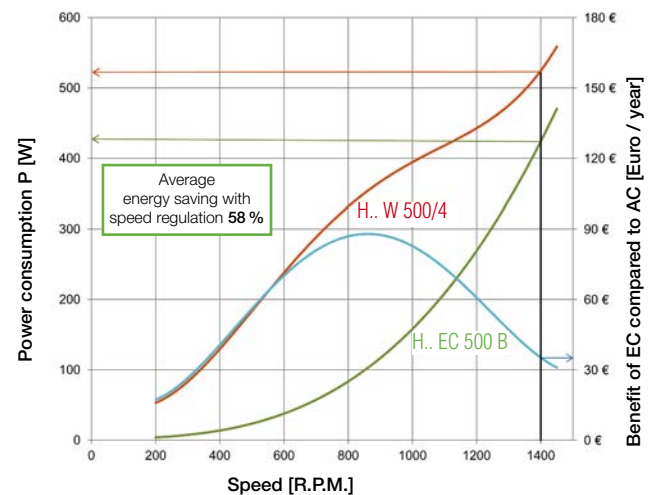

Fig. 2: Partial load operation

Calculation based on following framework conditions:
Conveyor cap. free discharge. Operation 8 h/day, 365 days/year = 2920 h/year
Electricity price 0.24 Euro/KWh

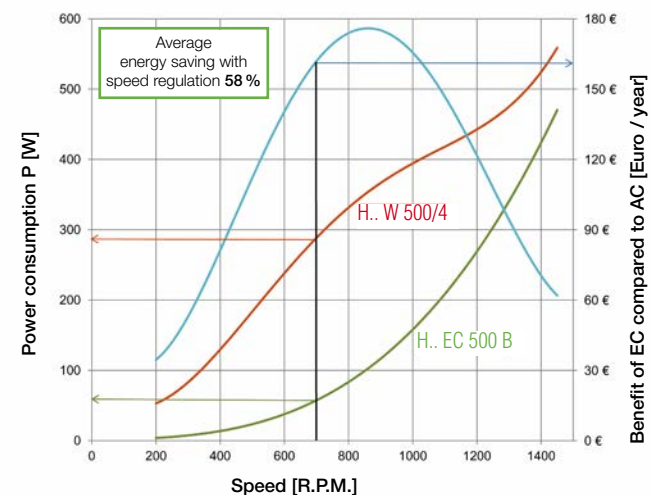

Table 1: Efficiency analysis

	AC Type H.. W 500/4	EC Type H.. EC 500 B	Saving
Operating mode 1	Full load 100 %	Full load 100 %	
Electrical power consumption W	525	424	
Operating hours p.a. (at 4h/day)	1460	1460	
Energy consumption kWh/a	767	619	148 kWh/a
Energy costs p.a. (0.24 Euro/kWh)	184	149	35 Euro p.a.
Saving in % p.a.			19.3 %
Operating mode 2	Part. load 50%(140V)	Part. load 50%(5V)	
Electrical power consumption W	289	57	
Operating hours p.a. (at 8h/day)	2920	2920	
Energy consumption kWh/a	844	166	678 kWh/a
Energy costs p.a. (0.24 Euro/kWh)	203	40	163 Euro p.a.
Saving in % p.a.			80.3 %
Mixed operation 1 + 2	Mixed operation	Mixed operation	
Energy consumption kWh/a	1611	785	826 kWh/a
Energy costs p.a. (0.2369 Euro/kWh)	387	188	198 Euro p.a.
Saving in % p.a.			51.3 %

World-class small room fans.
Premium design with highest
energy efficiency.



M1

Insulated building envelopes and negative environmental influences make mechanical ventilation indispensable nowadays.

The traditional ventilation of the home or workplace by opening windows is no longer an effective solution and it wastes valuable energy.

The small room fans MiniVent® M1 stand for top pressure performance, lowest noise levels and maximum energy efficiency. Two power stages, spray water protection IP X5 and high-quality long-life ball bearings are standard features with clear added value.

Equipped with Helios ultraSilence® technology, MiniVent® runs almost silently and consumes around a third less energy than traditional small room fans.

The minimalist premium design fits in any room through understated elegance.

Fully developed and manufactured in Germany, MiniVent® ensures compliance with the highest quality standards.

In addition to MiniVent[®], Helios offers a wide range of fans for ventilation and extraction in residential and smaller commercial premises.

The devices stand out through their innovative design and they meet the highest technical requirements.

FANS FOR WALL,
CEILING AND WINDOW
INSTALLATION



22^{on}

CENTRIFUGAL FANS
WITH EXHAUST SPIGOTS
Ø 100 MM



32

IN-DUCT FANS



33

EXTERNAL WALL FANS



34

WINDOW FANS



36

CEILING FANS



38

FAN HEATERS



39^{on}

CONTROLLED
HOME VENTILATION
SYSTEMS

42^{on}

M1/100

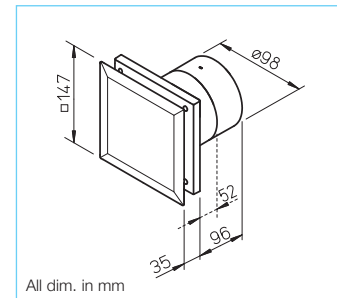

All dim. in mm

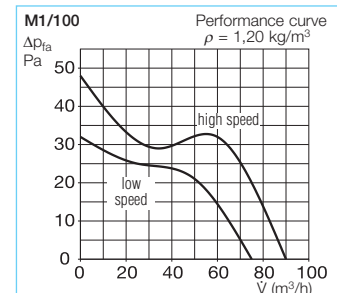

■ Mini fans of highest quality. Design and performance of the MiniVent® M1/100 sets the standard for the mini fans range.

The excellent design of the MiniVent® M1/100 blends in everywhere beautifully. The compact and attractively designed fascia shields the view of the fan interior completely.

All M1/100 models are supplied with 2 speeds and with airtight back draught shutter as standard.

The noise level is extremely low due to Helios ultraSilence® technology.

Available with interval function, overrun timer or automatic function like motion sensor or humidity controlled operation. This responds with intelligent electronics and prevents development of mildew effectively.

Suitable for all ventilation applications in bathrooms, toilets and other small rooms.

■ Features

- Lowest power consumption of only 5 Watt at vol. = 75 m³/h.
- Extremely quiet due to the ultraSilence® technology; just 25 dB(A)* at vol. = 75 m³/h.
- Pressure capacity: 60 m³/h air flow rate at 31 Pa resistance. 90 m³/h free discharge, ΔP max. 45 Pa.
- Where space is limited the guide vane of M1/100 can be simply removed. Thus reducing the installation depth to 52 from 96 mm.
- Compact dimensions for flush mounted installation in walls, shafts or ceilings with nominal dia. 100 mm.
- All components made from high quality white polymers.
- The motor design and ball bearings are selected for long-term durability, steady performance and lifelong operational reliability.
- Motor supplied with thermal overload protection, providing maintenance and trouble-free, continuous operation.
- Suitable for use in zone 1 of bathrooms according to DIN VDE 0100-701.
- The electrical supply cables to the unit may be recessed or surface mounted.
- Practical quick assembly using the push on cable connectors for the electrical connection.

Type	M1/100	M1/100 N/C	M1/100 F	M1/100 P
Ref. no.	6171	6172	6175	6174
Model	Standard model equipped with two speeds	As M1/100, with adjustable overrun and interval timer ¹⁾	As M1/100, with automatic humidity control ¹⁾⁴⁾	As M1/100, with PRI motion sensor ¹⁾
Run on time, min. optionally on high or low speed	—	6, 10, 15, 21 adjustable	6, 12, 18, 24 adjustable ³⁾	6
Interval operation, hrs. optionally on high or low speed	—	0, 8, 12, 24 adjustable	—	—
Delayed start, approx. sec.	—	0, 45, 90, 120	0 or 45 ³⁾	—
Back draught shutter, mech., remov.	Yes	Yes	Yes	Yes
Air flow volume (FID) m³/h	90 / 75	90 / 75	90 / 75	90 / 75
Impeller Ø mm	92	92	92	92
R.P.M. min ⁻¹	2650 / 2250	2650 / 2250	2650 / 2250	2650 / 2250
Voltage/Frequency 50 Hz	230 V	230 V	230 V	230 V
Power consumption W	9 / 5	9 / 5	9 / 5	9 / 5
Rated current A	0.06 / 0.04	0.06 / 0.04	0.06 / 0.04	0.06 / 0.04
Sound pressure level dB(A) in 3 m ²⁾	30 / 25	30 / 25	30 / 25	30 / 25
Wiring diagram no.	915	917	919	918
Electrical power supply NYM-O in mm ²	3 x 1,5	4 x 1,5	4 x 1,5	3 x 1,5
Protection cat. II, protection	IP 45	IP 45	IP 45	IP 45
Max. air flow temperature	+40 °C	+40 °C	+40 °C	+40 °C
Weight approx. kg	0,80	0,80	0,80	0,80

¹⁾ All electronic functions optionally on high or low speed - adjustable.

²⁾ Freefield conditions.

³⁾ With manual operation.

⁴⁾ Limit value 60, 70, 80, 90% adjustable.

Nice and clean

Since every fan gets dirty sooner or later, the M1 facia was designed in a way that air flows in on all sides. The design of the facia elegantly avoids the internal view of the fan opening, even when dirty.

M1 blends harmoniously into any environment. The smooth-surfaced facade always remains easy to maintain and clean.



Intelligent humidity control

The humidity control of the M1/100 F starts the fan automatically with increase of humidity. The fan operates until the humidity is reduced below the set point. With constantly high humidity the fan changes into a defined interval operation.

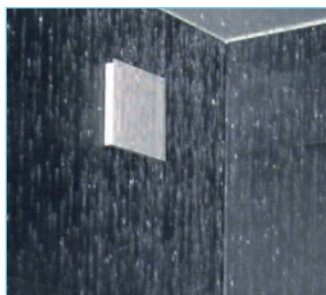

Connected at lightning speed

A generously dimensioned, circular cable storage space, the simple rotatability of the casing and the push on cable connectors assist the electrical connection enormously. Ball bearings (approx. 40 000 hours running) allow the installation in any position, also directly in the ceiling.



Flexible installation depth

Removable guide vane reduces installation depth from 96 to 52 mm. Can be installed with or without back draught shutter.



Suitable for use in zone 1

MiniVent® M1/100 provides protection to IP 45, insulation class II and may be used in accordance with DIN VDE 0100-701 in zone 1 bathrooms.



Wall mounting kit

Type WES 100 Ref. no. 0717

Two telescopic polymer sleeves guide the air through cavity walls and serve as wall liners.

Outside wall termination possible in two ways:

- Three bladed automatic back draught louvre shutter.
- Fixed grille. All parts made of high quality polymer.

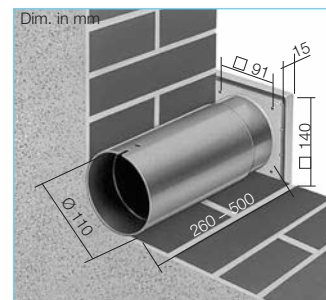

Telescopic wall sleeve

Type TWH 100 Ref. no. 6352

As WES, however without back draught louvre shutter and grille.

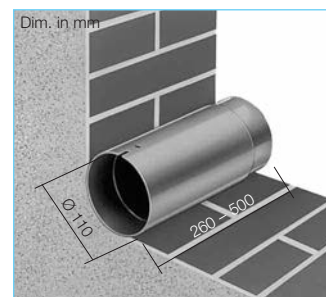

Operation switch 0-1-2 for standard model

Type MVB Ref. no. 6091

Two speed and on/off switch.

Current 3 A (ind.)
Voltage 230 V, 1~, 50/60 Hz
Protection to IP 30
Installation in standard gang boxes
Dimensions mm W 80 x H 80 x D 15
Weight approx. 0.1 kg



Mounting plate

MBR 90/160/300 Ref. no. 0281

Made from high quality, impact resistant polymer. Colour: white. Ideal for refurbishment of old housing. Easy installation of all M1-models in existing rectangular shaft openings. To make the plate almost invisible it can be painted or wallpapered.

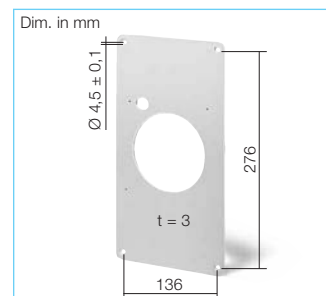

Spacer frame

Type MF 100 Ref. no. 6188

To reduce the installation depth in thin walls, narrow duct and tight 90° bends. Also suitable for the assembly of a pull cord switch (accessories). More MF 100 can be put on top of each other, if necessary.

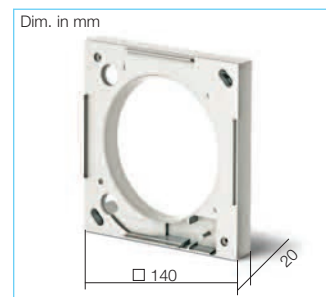

Accessory details Page

Flexible ducting, roof outlets and grilles	487 on
Air intakes	512 on

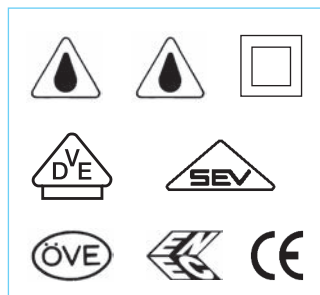

M1/120

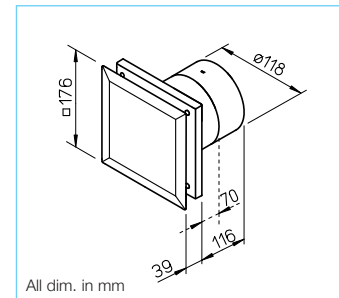

All dim. in mm

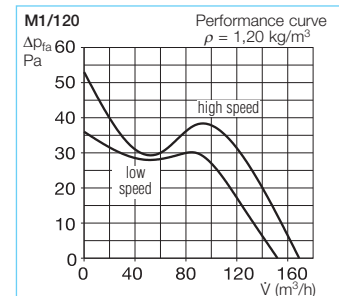

■ Mini fans of highest quality. Design and performance of the MiniVent® M1/120 sets the standard for the mini fans range.

The excellent design of the MiniVent® M1/120 blends in everywhere beautifully. The compact and attractively designed fascia shields the view of the fan interior completely.

All M1/120 models are supplied with 2 speeds and with airtight back draught shutter as standard.

The noise level is extremely low due to Helios ultraSilence® technology.

Available with interval function, overrun timer or automatic function like motion sensor or humidity controlled operation. This responds with intelligent electronics and prevents development of mildew effectively.

Suitable for the ventilation of small to medium-sized rooms in private, commercial and industrial areas.

■ Features

- Lowest power consumption of only 10 Watt at vol. = 150 m³/h.
- Extremely quiet due to the ultraSilence® technology; just 32 dB(A)* at vol. = 150 m³/h.
- Pressure capacity: 120 m³/h air flow rate at 31 Pa resistance. 170 m³/h free discharge, ΔP max. 53 Pa.
- Where space is limited the guide vane of M1/120 can be simply removed. Thus reducing the installation depth to 116 from 70 mm.
- Compact dimensions for flush mounted installation in walls, shafts or ceilings with nominal dia. 120/125 mm.
- All components made from high quality white polymers.
- The motor design and ball bearings are selected for long-term durability, steady performance and lifelong operational reliability.
- Motor supplied with thermal overload protection, providing maintenance and trouble-free, continuous operation.
- Suitable for use in zone 1 of bathrooms according to DIN VDE 0100-701.
- The electrical supply cables to the unit may be recessed or surface mounted.
- Practical quick assembly using the push on cable connectors for the electrical connection.

Type	M1/120	M1/120 N/C	M1/120 F	M1/120 P
Ref. no.	6360	6361	6364	6363
Model	Standard model equipped with two speeds	As M1/120, with adjustable overrun and interval timer ¹⁾	As M1/120, with automatic humidity control ¹⁾⁴⁾	As M1/120, with PIR motion sensor ¹⁾
Run on time, min. optionally on high or low speed	—	6, 10, 15, 21 adjustable	6, 12, 18, 24 adjustable ³⁾	6
Interval operation, hrs. optionally on high or low speed	—	0, 8, 12, 24 adjustable	—	—
Delayed start, approx. sec.	—	0, 45, 90, 120	0 or 45 ³⁾	—
Back draught shutter, mech., remov.	Yes	Yes	Yes	Yes
Air flow volume (FID) m³/h	170 / 150	170 / 150	170 / 150	170 / 150
Impeller Ø mm	111	111	111	111
R.P.M. min ⁻¹	2350 / 2050	2350 / 2050	2350 / 2050	2350 / 2050
Voltage/Frequency 50 Hz	230 V	230 V	230 V	230 V
Power consumption W	13 / 10	13 / 10	13 / 10	13 / 10
Rated current A	0,09 / 0,08	0,09 / 0,08	0,09 / 0,08	0,09 / 0,08
Sound pressure level dB(A) in 3 m ²⁾	36 / 32	36 / 32	36 / 32	36 / 32
Wiring diagram no.	915	917	919	918
Electrical power supply NYM-O in mm ²	3 x 1.5	4 x 1.5	4 x 1.5	3 x 1.5
Protection cat. II, protection	IP 45	IP 45	IP 45	IP 45
Max. air flow temperature	+40 °C	+40 °C	+40 °C	+40 °C
Weight approx. kg	1,05	1,05	1,05	1,05

¹⁾ All electronic functions optionally on high or low speed - adjustable.

²⁾ Freefield conditions.

³⁾ With manual operation.

⁴⁾ Limit value 60, 70, 80, 90% adjustable.

Nice and clean

Since every fan gets dirty sooner or later, the M1 fascia was designed in a way that air flows in on all sides. The design of the fascia elegantly avoids the internal view of the fan opening, even when dirty.

M1 blends harmoniously into any environment. The smooth-surfaced facade always remains easy to maintain and clean.



Intelligent humidity control

The humidity control of the M1/120 F starts the fan automatically with increase of humidity. The fan operates until the humidity is reduced below the set point. With constantly high humidity the fan changes into a defined interval operation.

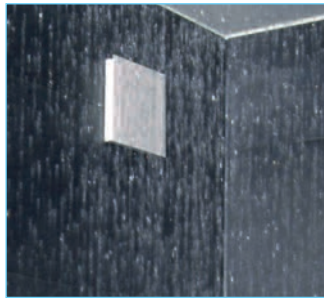

Connected at lightning speed

A generously dimensioned, circular cable storage space, the simple rotatability of the casing and the push on cable connectors assist the electrical connection enormously.

Ball bearings (approx. 40 000 hours running) allow the installation in any position, also directly in the ceiling.



Wall mounting kit

Type WES 120 Ref. no. 0486

Two telescopic polymer sleeves guide the air through cavity walls and serve as wall liners. Outside wall termination is carried out by application of three bladed automatic back draught louvre shutter.

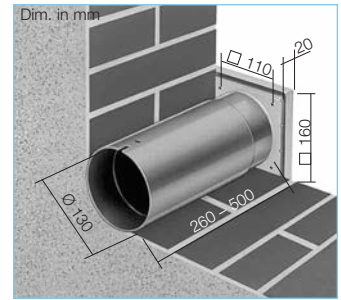

Telescopic wall sleeve

Type TWH 120 Ref. no. 6353

As WES, however without back draught louvre shutter.

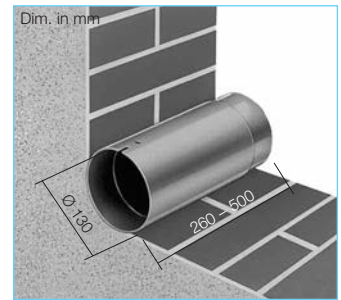

Operation switch 0-1-2 for standard model

Type MVB Ref. no. 6091

Two speed and on/off switch.

Current 3 A (ind.)
Voltage 230 V, 1~, 50/60 Hz
Protection to IP 30
Installation in standard gang boxes
Dimensions mm W 80 x H 80 x D 15
Weight approx. 0.1 kg



Accessory details	Page
Flexible ducting, roof outlets and grilles	487 on
Air intakes	512 on

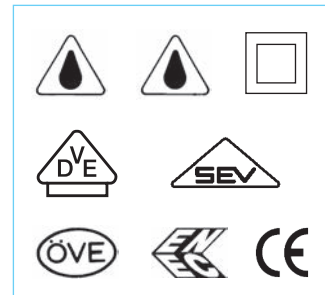

Flexible installation depth

Removable guide vane reduces installation depth from 116 to 70 mm. Can be installed with or without back draught shutter.

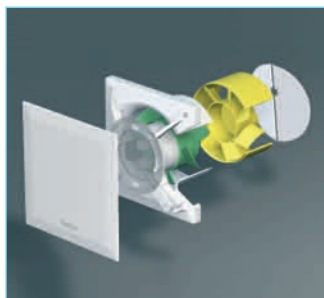

Suitable for use in zone 1

MiniVent® M1/120 provides protection to IP 45, insulation class II and may be used in accordance with DIN VDE 0100-701 in zone 1 bathrooms.

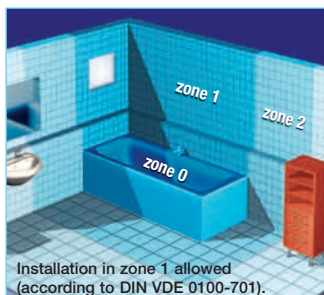

Installation in zone 1 allowed (according to DIN VDE 0100-701).

M1/150

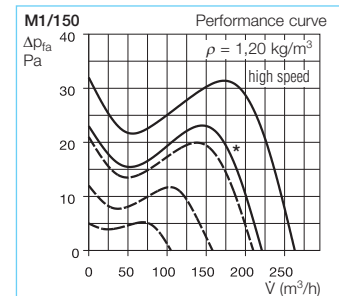
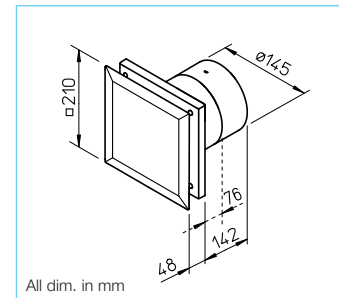

■ Mini fans of highest quality. Design and performance of the MiniVent® M1/120 sets the standard for the mini fans range.

The excellent design of the MiniVent® M1/120 blends in everywhere beautifully. The compact and attractively designed fascia shields the view of the fan interior completely.

All M1/150 models are supplied with highly efficient EC motor technology, with 2 speeds and with airtight back draught shutter as standard.

The noise level is extremely low due to Helios ultraSilence® technology.

stepless speed regulation. This responds with intelligent electronics and prevents development of mildew effectively. Suitable for the ventilation of small to medium-sized rooms in private, commercial and industrial areas.

■ Features

- Lowest power consumption of only 6 Watt at vol. = 220 m³/h.
- Extremely quiet due to the ultraSilence® technology; just 35 dB(A)* at vol. = 220 m³/h.
- Pressure capacity: 180 m³/h air flow rate at 31 Pa resistance. 260 m³/h free discharge, ΔP max. 33 Pa.
- Where space is limited the guide vane of M1/150 can be simply removed. Thus reducing the installation depth to 142 from 76 mm.
- Compact dimensions for flush mounted installation in walls, shafts or ceilings with nominal dia. 150/160 mm.
- All components made from high quality white polymers.
- The motor design and ball bearings are selected for long-term durability, steady performance and lifelong operational reliability.
- Motor supplied with thermal overload protection, providing maintenance and trouble-free, continuous operation.
- Suitable for use in zone 1 of bathrooms according to DIN VDE 0100-701.
- The electrical supply cables to the unit may be recessed or surface mounted.
- Practical quick assembly using the push on cable connectors for the electrical connection.
- The 0-10 V Type has various applications due to the combination with CO₂, VOC or temperature sensors. Furthermore, the min./max. speed is fully adjustable and stepless regulation is possible with a potentiometer. The unit can also be controlled with the three-step switch or steplessly via universal control systems or electronic differential pressure/temperature controllers. A potential-free relay output is available as standard for the connection of an electrical cover flap.

Type	M1/150	M1/150 N/C	M1/150 F	M1/150 0-10 V
Ref. no.	6041	6042	6043	6044
Model	Standard model equipped with two speeds	As M1/150, with adjustable overrun and interval timer ¹⁾	As M1/150, with automatic humidity control ^{1) 4)}	Stepless control
Run on time, min. optionally on high, low or both speeds	—	6, 10, 15, 21 adjustable	6, 10, 15, 21 adjustable ³⁾	6
Interval operation, hrs. optionally on high, low or both speeds	—	0, 8, 12, 24 adjustable	—	—
Delayed start, approx. sec.	—	0, 45, 90, 120	0, 45, 90, 120 ³⁾	—
Internal shutter, removable	Yes	Yes	Yes	Yes
Air flow volume m³/h free discharge	260 / 220	260 / 220	260 / 220	260-50
Impeller Ø mm	137	137	137	137
R.P.M. min ⁻¹	1900 / 1600	1900 / 1600	1900 / 1600	1900-980
Voltage / Frequency 50 Hz	230 V	230 V	230 V	230 V
Power consumption W	8 / 4.5	8 / 5	9 / 6	9 / min. 3.5
Rated current A	0,08 / 0,06	0,10 / 0,09	0,08 / 0,06	0,08 / min. 0,035
Sound pressure level dB(A) in 3 m ²⁾	39 / 35	39 / 35	39 / 35	max. 39
Wiring diagram no.	1080	1081	1082	1083
Electrical power supply NYM-O in mm ²	3 x 1.5	4 x 1.5	4 x 1.5	2 x 1.5 ⁵⁾
Elec. power supply (control) LiYY in mm ²	—	—	—	3 x 0.34
Protection cat. II, protection class	IP 45	IP 45	IP 45	IP 45
Max. air flow temperature	+40 °C	+40 °C	+40 °C	+40 °C
Weight approx. kg	1.20	1.20	1.20	1.20

¹⁾ All adjustable times and electronic functions optionally on high, low or both speeds - adjustable.

²⁾ Free field conditions.

³⁾ With manual operation.

⁴⁾ Limit value from 40-90 % steplessly adjustable.

⁵⁾ Additional connection cable provided for relay output.

Nice and clean

Since every fan gets dirty sooner or later, the M1 fascia was designed in a way that air flows in on all sides. The design of the fascia elegantly avoids the internal view of the fan opening, even when dirty.

M1 blends harmoniously into any environment. The smooth-surfaced facade always remains easy to maintain and clean.



Intelligent humidity control

The humidity control of the M1/150 F starts the fan automatically with increase of humidity. The fan operates until the humidity is reduced below the set point. With constantly high humidity the fan changes into a defined interval operation.

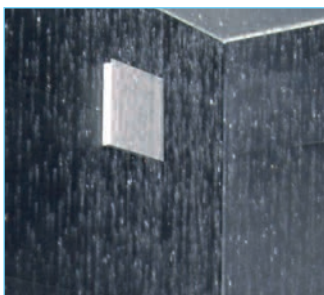

Connected at lightning speed

A generously dimensioned, circular cable storage space, the simple rotatability of the casing and the push on cable connectors assist the electrical connection enormously. Ball bearings (approx. 40 000 hours running) allow the installation in any position, also directly in the ceiling.



Flexible installation depth

Removable guide vane reduces installation depth from 142 to 76 mm. Can be installed with or without back draught shutter.



Suitable for use in zone 1

MiniVent® M1/150 provides protection to IP 45, insulation class II and may be used in accordance with DIN VDE 0100-701 in zone 1 bathrooms.

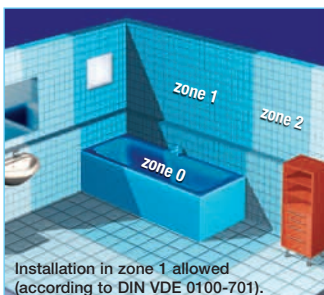

Wall mounting kit

Type WES 150 Ref. no. 0537

Two telescopic polymer sleeves guide the air through cavity walls and serve as wall liners.

Outside wall termination possible in two ways:

- Three bladed automatic back draught louvre shutter.
- Fixed grille. All parts made of high quality polymer.

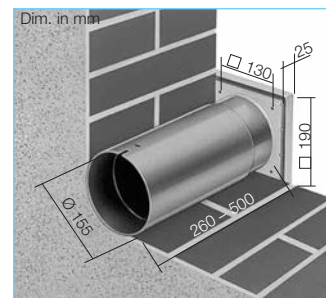

Telescopic wall sleeve

Type TWH 150 Ref. no. 6354

As WES, however without back draught louvre shutter and grille.

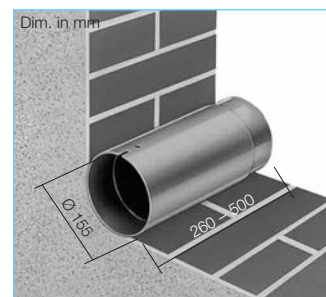

Operation switch 0-1-2 for standard model

Type MVB Ref. no. 6091

Two speed and on/off switch.

Current 3 A (ind.)
Voltage 230 V, 1~, 50/60 Hz
Protection to IP 30
Installation in standard gang boxes
Dimensions mm W 80 x H 80 x D 15
Weight approx. 0.1 kg



Operation switch for M1/150 N/C and M1/150 F

Type DSEL 2 Ref. no. 1306

Two speed and on/off switch.

Current 3 A (ind.)
Voltage 230 V, 1~, 50/60 Hz
Protection to IP 30
Installation in standard gang boxes
Dimensions mm W 80 x H 80 x D 15
Weight approx. 0.1 kg



Speed-potentiometer for M1/150 0-10 V

On/off switch, stepless speed control.

Type PU 10 Ref. no. 1734

For flush mounting.

Installation in Standard UP-Dose
Dim. mm W 80 x H 80 x D 21 protr.

Type PA 10 Ref. no. 1735

For surface mounting.

Casing Surface installation
Dim. mm W 80 x H 80 x D 65

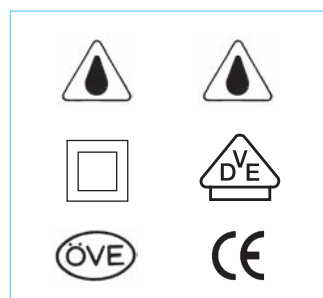

Accessory details	Page
Flexible ducting, roof outlets and grilles	487 on
Air intakes	512 on
Universal control system, speed-potentiometer	539 on

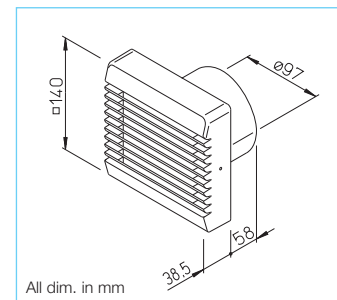

All dim. in mm

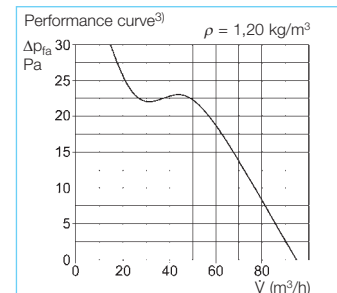

■ High-quality mini fan with electric shutter. The shutter blades behind the facade open and close noiselessly and automatically when the fan is switched on/off. This ensures the vibration-free connection for outside air when the ventilator is at a standstill. The long-life ball bearings ensure maintenance-free, silent operation and allow installation in any position.

Unobtrusive, HR 90 KE blends into every room ambience. The upward-facing blades shield the view of the fan interior. Suitable for all ventilation applications in bathrooms, toilets and other small rooms.

■ Advantages of ball bearings

- Quiet and reliable performance under continuous operation.
- Acoustically tested long life ball bearings are greased for life (approx. 30 000 hours running). Maintenance, re-greasing and cleaning of bearings are not required, saving time and money.
- Even under harshest conditions, longlife ball bearings ensure that the fans will perform quietly for life.
- Ball bearings and motor are designed for long-term durability, constant performance and life-long operational safety.
- Suitable for use in zone 1 of bathrooms according to DIN VDE 0100-701.
- Flush mounting in Ø 100 mm ducting or shafts.
- Can be used practically anywhere due to small installation depth and small dimensions.
- Attractive Soft-Line Design in pleasant white.
- All components made from impact resistant polymers.
- Contact safety to DIN EN ISO 13857.
- Motor protected by automatically resetting thermal contact. Maintenance-free and interference-free. Suitable for continuous operation.
- Cable entry can be flush or on the surface.
- Easy electrical connection through screwless clamps.
- Spring clips for fixing into Ø 100 mm ducting or screw fixing in larger openings.

Type	HR 90 KE	HR 90 KEZ
Ref. no.	0334	0335
Built-in overrun timer ¹⁾ , Overrun timer approx. 2-8 min.		ja ²⁾
Electric shutter	ja	ja
Air flow volume (FID) m ³ /h ³⁾	95	95
Impeller Ø mm	93	93
R.P.M. min ⁻¹	2550	2550
Voltage/Frequency 50/60 Hz	230 V	230 V
Power consumption W	17	20
Current A	0,12	0,14
Sound pressure level dB(A) in 1 m	44	44
Wiring diagram no.	483	484
Protection class II, protection	IP 45	IP 45
Max. air flow temperature	+40 °C	+40 °C
Weight approx. kg	0,60	0,62

■ Note
HR 90 K 12 V –
with safety extra-low voltage
upon request

¹⁾ delayed start of approximately 1 minute
³⁾ determined with extract duct, Length 2 x D

²⁾ NYM-0 3 x 1.5 mm² required

■ Mini fan HR 90 KE

for ceiling installation

Fans with ball bearings are ideally suited for ceiling installation. Spacer frame MF 90 (accessory) prevents condensation from ducting entering the fan.



■ Screwless installation

HR 90 KE fans have screwless clamps for electrical connection. The fascia is fixed quickly and easily through a click in mechanism. Spring clips on the sides simplify installation into Ø 100 mm ductings.

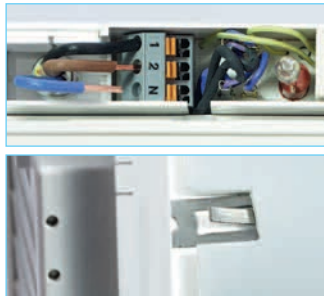

■ Suitable for use in zone 1

HR 90 KE models provide protection to IP X5 and may be used in accordance with DIN VDE 0100-701 in zone 1 of bathrooms.

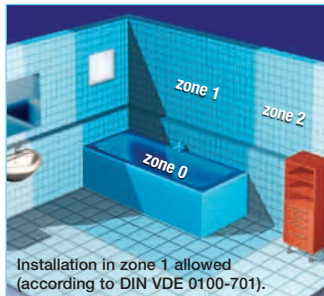

■ Installation in any position

HR 90 KE is equipped with electric shutter and high quality long life ball bearings. This ensures a wall and ceiling installation in any position – vertical, horizontal or any position in between.

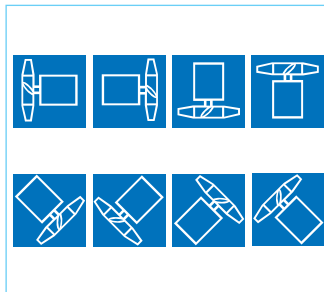

■ Approvals

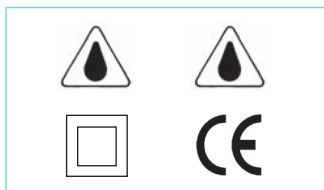

Wall mounting kit

Type WES 90 Ref. no. 0717

Two telescopic sleeves guide air through cavity walls and serve as wall liners; for flush mounted installation.

There are two possibilities for wall termination:

- Three bladed automatic backdraught shutter.
- Fixed grille. All parts from high-quality polymer.

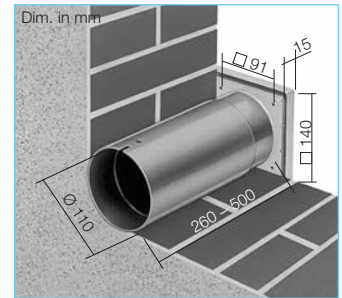

Telescopic wall sleeve

Type TWH 90 Ref. no. 6352

As WES, however without back draught louvre shutter and grille.

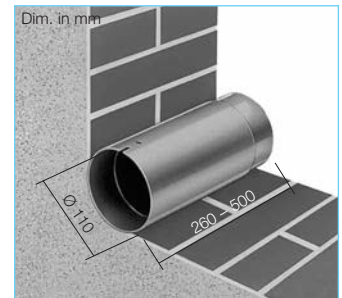

Window kit

Type FES 90 Ref. no. 0462

For installation of HR 90 KE models are suitable for single and double glazed windows as well as panels from 1 mm up to 40 mm thick. Outside cover only 29 mm through flat rain repellent grille. Pull cord operation.

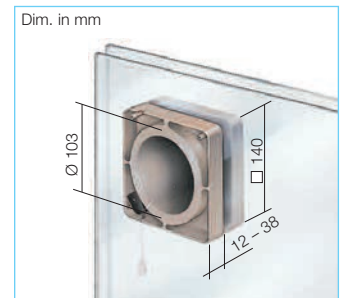

Mounting plate

MBR 90/160/300 Ref. no. 0281

From high quality, impact resistant polymer. Colour: white. Ideal for refurbishment of old housing. Easy installation of HR 90 KE models in existing rectangular shaft openings. To make the plate invisible it can be painted or wall-papered.

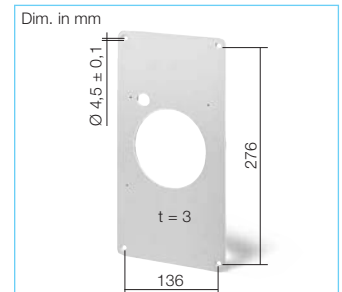

Spacer frame

Type MF 90 Ref. no. 0819

Areas of application:

- Required for ceiling installation. MF prevents condensation entering the fan from vertical ductings.
- For easy installation of awkwardly placed electrical cables, because the fan will be lifted about 23 mm from the wall.
- For easy installation of the fan in tight shafts. MF reduces fan spigot protrusion e.g. tight 90° bends.
- For installation in thin walls the fan spigot protrusion can be reduced as follows:
With 1 spacer frame to 35 mm.
With 2 spacer frames to 7 mm.
Colour: alpine white.

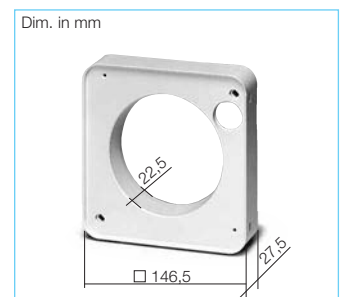

■ Accessory details Page

Flexible ducting, roof outlets and grilles	487 on
Air intakes	512 on
Speed controllers, switches and overrun timer	525 on

HVR 150

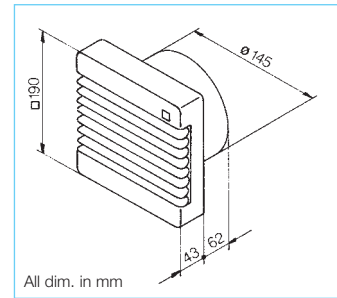

All dim. in mm

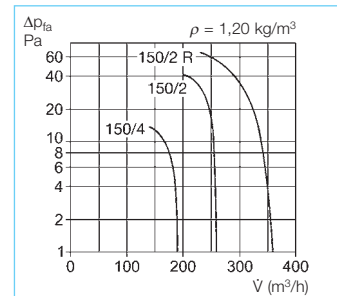

■ The HelioVent® fans are designed to ventilate smaller to mid-sized domestic, commercial and industrial rooms.

- The fan with ball bearings as standard guarantees
 - Installation in any position.
 - Quiet and reliable performance under continuous operation.
 - Silent and maintenance free for life.

■ **Features**

- Front grille can be removed and easily cleaned in soapy water.
- Small depth avoids possible installation difficulties.
- Suitable for wall, window and ceiling installation in any position.
- Adjustment of flow volume through stepless, electronic speed control.
- Motor protection through built-in thermal contacts.

■ **Specification**

The traditional design blends well in any room. All parts, including fan casing and impeller are made from high quality polymer. White facia. Built-in neon light indicates operation. High volume and pressure characteristic using a 8 bladed impeller and guide vanes.

Totally enclosed, maintenance free running low noise ball bearing motor, sealed for life, interference-free, suitable for continuous operation. Installation in any position. Contact safety to DIN EN ISO 13857.

The electrical supply cables to the unit may be recessed or surface mounted.

Window mounting kit

Type FES 150 Ref. no. 0463

For installation with all models, preferably models with electrical internal shutter. Suitable for single and double glazed windows as well as thin walls and panels. Wall termination through flat rain repellent grille with fixed blades. Controllable with pull cord supplied, or by a remote switch, to be installed on site.

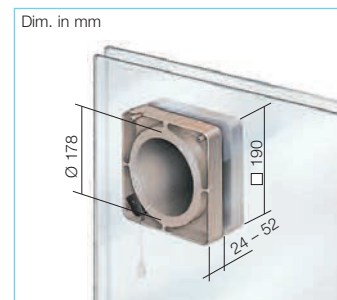

Dim. in mm

Wall mounting kit

Type WES 150 Ref. no. 0537

For flush mounted wall installation; contents: Two telescopic polymer sleeves adjustable on wall thickness and wall termination that can either be mounted with a gravity shutter or on the HVR E models with a rain repellent grille. Supplied with both elements as standard.

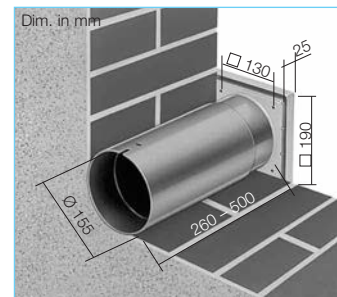

Dim. in mm

■ **Accessory details** Page

Roof outlets and grilles	487 on
Air intake	512 on
Speed controllers, switches and overrun timer	525 on

Telescopic wall sleeve

Type TWH 150 Ref. no. 6354

As WES, however without back draught louvre shutter and grille.

Type	HVR 150/4 E	HVR 150/2 E	HVR 150/2 RE
Ref. no.	0283	0285	0286
Built-in electric shutter	Yes	Yes	Yes
Air flow reversible	—	—	DSEL 2¹⁾ Ref. no. 1306
Air flow volume (FID) m³/h	180	260	360
Impeller Ø mm	140	140	140
R.P.M. min ⁻¹ ca.	1300	1800	2600
Voltage/Frequency	230 V~ / 50 Hz	230 V~ / 50 Hz	230 V~ / 50 Hz
Power consumption W	30	35	50
Current A	0.20	0.15	0.25
Sound pressure level dB(A) in 1 m	46	58	64
Wiring diagram no.	283	283	284.1
Protection class II, protection to	IP 44	IP 44	IP 44
Max. air flow temperature	+40 °C	+40 °C	+40 °C
Weight approx. kg	1.2	1.4	1.5

¹⁾ NYM-O 3 x 1.5 mm² cable required for reverse operation

HV 200 and HV 250

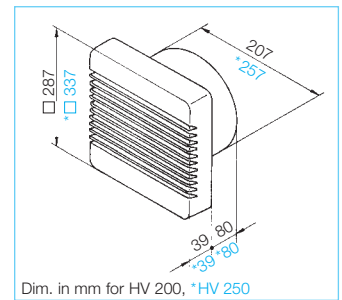

Dim. in mm for HV 200, *HV 250

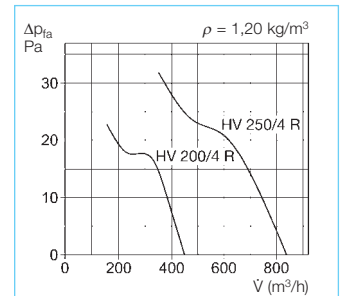

- **HelioVent®. The traditional design blends well in any stylish room: In living and dining room, in offices and conference rooms, restaurants or foyers.**
Universal in operation. Reversible for ventilation and extraction. Installation in wall, ceiling or any angle.

- **HelioVent® at a glance**
Compact, quiet fan unit with clever design features:
 - HelioVent® matches every location inconspicuously.
 - No view of the fan interior if it gets dirty.
 - High air flow and low air noise through low resistances.
 - Easy to care for. Facia is removable with one hand to be cleaned easily in soapy water.

- **Installation – Connection**
The installation is simple and done within minutes. Easy electrical connection through well-tried screwless clamps and large cable storage reduce effort to a minimum. Cable can be inserted flush or on the surface.

- **Speed control**
Speed controllable from 0 – 100% through voltage reduction with an electronic or transformer controller.

Accessory details	Page
Roof outlets and grilles	487 on
Air intakes	512 on
Speed controllers, switches and overrun timer	525 on

- **Specification**
 - Facia and fan casing from high quality, impact resistant alpine white polymer.
 - Totally enclosed, powerful motor with high efficiency. Corrosion-resistant in an aluminium diecast casing, protected against dust and water (protection to IP 54). With tropical protection of windings and insulation to ISO class B.
 - Overload protection through built-in thermal contacts (self resetting).
 - Noise resistant ball bearings ensure quiet operation.
 - Large terminals (protection to IP 55) and extra cable storage make installation easier
 - Impeller specifically designed for high performance with high efficiency and quiet operation.
 - Maintenance free and interference-free.
 - Contact safety to DIN EN ISO 13857 through facia.
 - Easy installation and service.

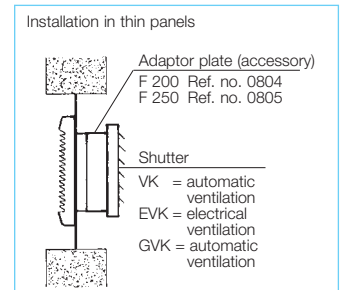
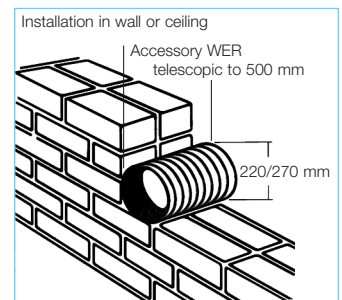

Type	HV 200/4 R	HV 250/4 R
Ref. no.	0957	0958
Air flow reversible	Yes	Yes
Air flow volume (FID) m³/h	450	840
Impeller Ø mm	200	250
R.P.M. min⁻¹	1360	1380
Voltage/Frequency	230 V~ / 50 Hz	230 V~ / 50 Hz
Power consumption W	30	40
Current A	0.13	0.20
Sound pressure level dB(A) bei 15 Pa in 1 m (freefield conditions)	52	55
Sound power dB(A)	60	63
Wiring diagram no.	439	439
Protection to	IP 54	IP 54
Max. air flow temperature	+40 °C	+40 °C
Weight approx. kg	2.1	2.6

Accessories Specification	Fan type	HV 200	HV 250
Wall sleeve for flush mounted wall installation	Type Ref. no.	WER 200 0368	WER 250/225 0369
Air stream operated shutter for extraction only	Type Ref. no.	VK 200 0758	VK 250 0759
Twin swing shutter ventilation and extraction	Type Ref. no.	GVK 200 0370	GVK 250 0371
Reversing switch ventilation and extraction	Type Ref. no.	DSEL 2 ¹⁾ 1306	DSEL 2 ¹⁾ 1306
Reversing speed controller for stepless variable speed	Type Ref. no.	BSX 0240	BSX 0240
Electronic speed controller Flush mounting	Type Ref. no.	ESU 1 0236	ESU 1 0236
Electronic speed controller Surface mounting	Type Ref. no.	ESA 1 0238	ESA 1 0238

1) NYM-J 4 x 1.5 mm² required for reverse operation



Efficiency class
F DX 200

■ Attractive design with the concealed intake opening characterises the universal models DX.

This range is powerful, easy to install and suitable for ventilation of rooms in both private and commercial applications.

■ Specification

- User friendly controls allow the unit to meet individual requirements for room conditions.
- Easy installation in any position. Flush installation possible by removing the outer casing.
- Exhaust spigot suitable for connection to \varnothing 100 mm ducting.
- Easily removable front for cleaning and maintenance.
- With integrated backdraught shutter.
- Maintenance free motor with thermal overload protection.

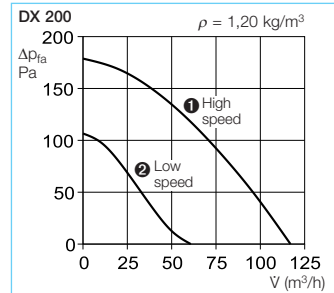
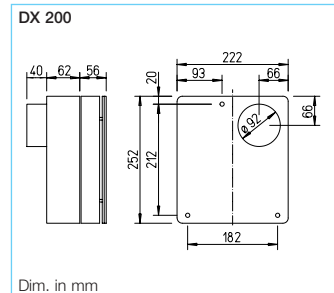

Accessory details	Page
Flexible ducting, roof outlets and grilles	487 on
Intake air elements	512 on
Speed controllers, switches and overrun timers	525 on

Technical data	
Type	DX 200
Ref. no.	1703
Operation	Stepless through electronic actuator ESU 1 / ESA 1, Ref. no. 0236 / 0238. Two speed operation possible using operation switch MVB, Ref. no. 6091.
Air flow volume on level free discharge $\text{m}^3/\text{h}^{1)}$	1 120 2 60
R.P.M. min^{-1}	2660
Voltage/Frequency	230 V- / 50 Hz
Power consumption W	33
Current A	0.24
Sound pressure level in 1 m $\text{dB(A)}^{1)}$	55 42
Wiring diagram no.	693.1
Protection class	IP X5
Maximum air flow temperature	+40 °C
Weight approx. kg	1.7

¹⁾ values depend on different speed levels.

■ Operation

Axial fans for smaller to medium air flows against low resistances. Suitable for many applications like room ventilation, cooling, drying etc.

■ Installation

Installation in any position. Air flow direction depending on installation. Suitable for insertion in ducting. Please note that pressure drops and resistances of ducting must be considered. For higher resistances centrifugal fans should be considered. Electrical connection on motor end cap. Ensure that fan is accessible for service.

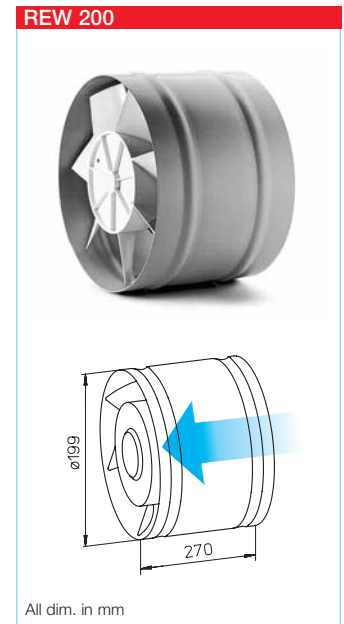
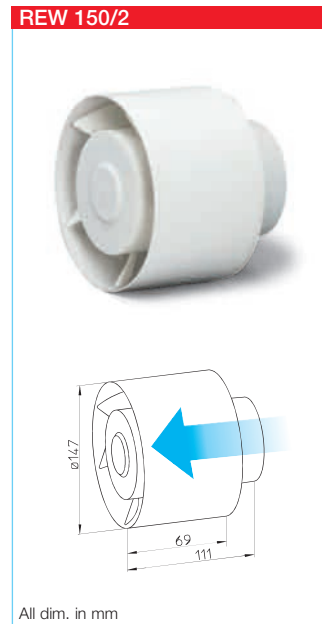
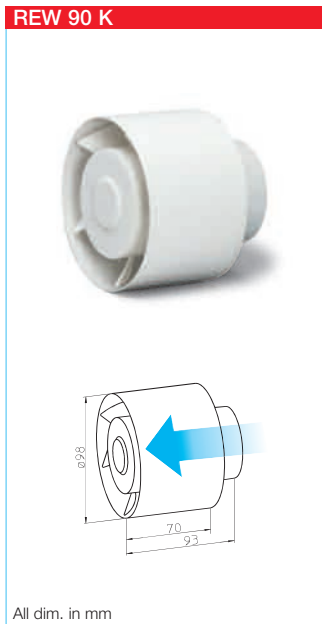

■ Specification

To be installed into ducting with nominal size \varnothing 100 mm. Casing of impact resistant polymer incorporating guide vanes. High pressure profiled 5 blade impeller of polymer. Ball bearing motor with thermal overload protection, maintenance free and suitable for continuous operation. Rear-mounted terminals for electrical connection.

■ Specification

To be installed into ducting with nominal size \varnothing 150 mm. Casing of impact resistant polymer incorporating guide vanes. High pressure profiled 8 blade impeller of polymer. Reversible ball bearing motor with thermal overload protection, maintenance free and suitable for continuous operation. Rear-mounted terminals for electrical connection.

■ Specification

To be installed into ducting with nominal size \varnothing 200 mm. Casing with two stiffening rings made from galvanised steel. High pressure profiled 7 blade impeller of polymer. Enclosed reversible ball bearing motor with thermal overload protection, tropical protection of windings and interference-free, maintenance free and suitable for continuous operation with aluminium die-cast casing. Terminals in motor cap.

Accessory details	Page
Flexible ducting, roof outlets and grilles	487 on
Air intake and extract elements and poppet valves	500 on
Speed controllers, switches and overrun timers	525 on

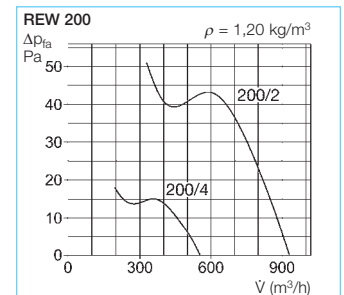
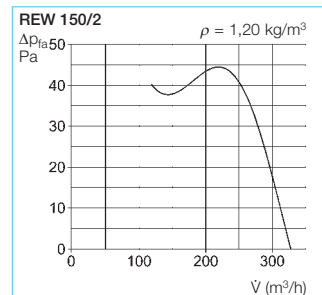
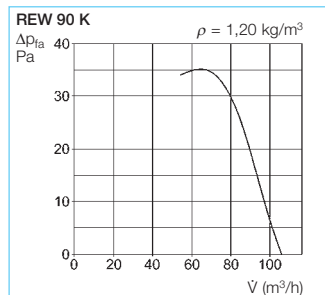

■ Accessories

Speed controller with reversing switch (for REW 150 and 200)
Type BSX Ref. no. 0240

Type	REW 90 K	REW 150/2	REW 200/4	REW 200/2
Ref. no.	0441	0440	7504	7505
Air flow reversible	no	DSEL 2 ¹⁾ No. 1306	DSEL 2 ²⁾ No. 1306	DSEL 2 ²⁾ No. 1306
Air flow volume (FID) m³/h	105	330	550	930
Impeller \varnothing mm	93	140	200	200
R.P.M. min ⁻¹	2320	2100	1350	2280
Voltage/Frequency	230 V- / 50 Hz	230 V- / 50 Hz	230 V- / 50 Hz	230 V- / 50 Hz
Power consumption W	15	29	40	70
Current A	0.10	0.13	0.28	0.33
Sound pressure level dB(A) in 1 m	45	56	44	57
Wiring diagram no.	479	478	439	439
Protection to	IP 55	IP 44	IP 54	IP 54
Max. air flow temperature	+40 °C	+40 °C	+50 °C	+50 °C
Weight approx. kg	0.46	1.1	2.0	2.5

¹⁾ NYM-O 3 x 1.5 mm² cable required for reverse operation

²⁾ NYM-J 4 x 1.5 mm² cable required for reverse operation

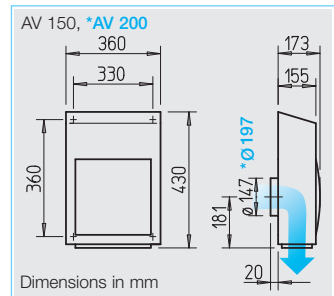
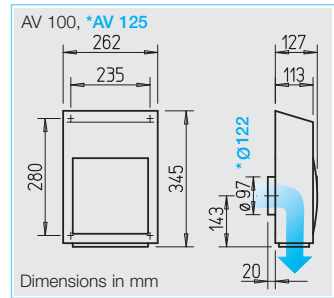

Application

Designed for the external wall installation to ventilate smaller to medium-sized rooms. Suitable for use in industrial, commercial and domestic rooms.

High pressure, efficient centrifugal fans allow the connection to circular ducting and to overcome resistances of filters and system components. Perfect solution to ventilate apartment kitchens, since there is no noise of kitchen hoods. This also applies with other applications ducting, since the fan noise is transferred to the outside. Perfect for additional installation with renovation and rebuilding.

Special features

- No disturbing fan noises indoors through external wall installation.
- Simple and economic assembly by bolting in place of operative unit.
- Weather-proof casing. Tight closing air steam-operated shutters with spring reset.
- Connecting spigot according to standard duct diameter for connection to wall duct or ducting.
- Solid base plate from polymer makes an assembly on uneven surfaces possible.
- Electrical supply cables to the unit may be recessed or surface mounted.

Casing

- Weather-proof casing made from galvanised sheet steel, powder coated in alpine white.
- Bird guard and two air operated louvers with spring mechanism for closing at the extract point.

Speed control

stepless by the use of electronic controller or 5-stepped by transformer controller.

Motor

Totally enclosed motor with ball bearings, impregnated windings, insulation class F, designed for continuous operation, maintenance free and interference-free.

Motor protection

Thermal contacts fitted as standard.

Impeller

Energy-saving centrifugal impeller with backward curved blades from polymer, dynamicaly balanced.

Information

Start-up of the fan is only permitted, if protection against accidental contact of impeller is given according to DIN EN ISO 13857.

Sound level

Total sound power levels and the spectrum figures in dB(A) for low and high speed are given above the performance curves. The sound emission figure is given as a sound pressure level at 3 m distance (freefield conditions) in the technical data table.

Note	Page
Speed controller, switch and overrun timer	525 on

Type	Ref. no.	Connection Ø	Max. air flow volume	Max. rehza	Max. Sound press level sound emission	Voltage 50 Hz	Max. power consumption	Max. current	Wiring diagram	Max. air flow temperature	weight net approx.	5 step transformer controller	Electronical speed controller, stepless flush / surface		
		mm	$\dot{V} \text{ m}^3/\text{h}$	min^{-1}	dB (A) in 3 m	Volt	W	A	No.	+ °C	kg	Type	Ref. no.	Type	Ref. no.
AV 100	2654	100	310	2710	46	230	55	0.24	937.2	60	5.0	TSW 1,5	1495	ESU 1/ESA 1	0236/0238
AV 125	2655	125	360	2470	45	230	54	0.24	937.2	60	5.0	TSW 1,5	1495	ESU 1/ESA 1	0236/0238
AV 150	2656	150	620	2520	50	230	100	0.44	937.2	55	8.3	TSW 1,5	1495	ESU 1/ESA 1	0236/0238
AV 200	2657	200	680	2530	51	230	100	0.44	937.2	55	8.3	TSW 1,5	1495	ESU 1/ESA 1	0236/0238

AV 100

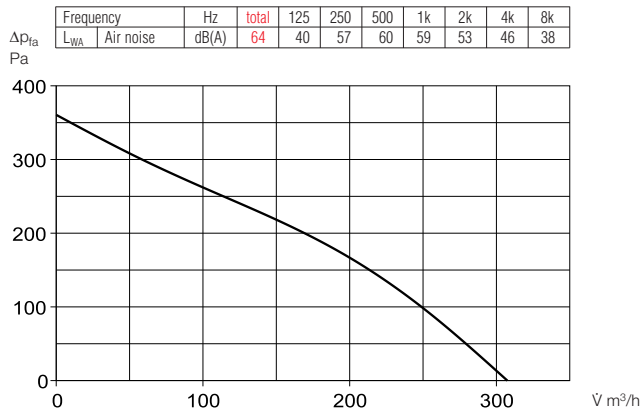

AV 125

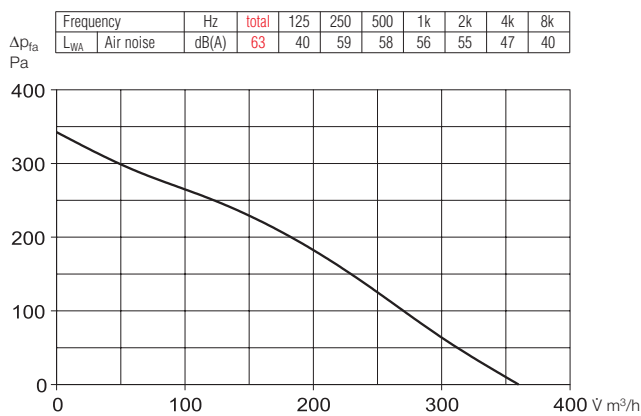

AV 150

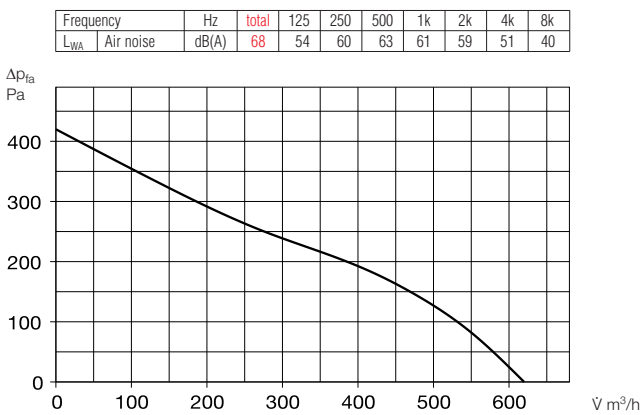

AV 200

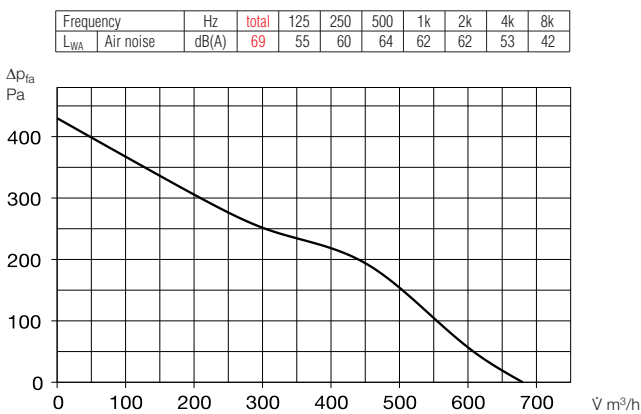

Accessories

Transformer controller

Type TSW 1,5 Ref. no. 1495
Five step transformer speed controller for surface mounting.
1. phase, 230 V.
Max. load 1,5 A
Wiring diagram no. 437.1
Dim. mm W 154 x H 200 x D 79



Electronic speed controller

Type ESU 1 Ref. no. 0236
For flush mounting.
White polymer casing and ring.
Installation in standard gang box behind switch. Operation display via illuminated ring.
Max. load 1 A.
Minimum load 0.15 A
Protection to (installed) IP 30
Wiring diagram no. 556.1
Dim. mm W 80 x H 80 x D 21 protr.



Electronic speed controller

Type ESA 1 Ref. no. 0238
White polymer casing. Operation display via illuminated ring in control knob.
Max. load 1 A.
Minimum load 0.15 A
Protection to IP 40
Wiring diagram no. 556.1
Dim. mm W 80 x H 80 x D 65



Attractively designed small window fans with air flow volumes from 80 – 360 m³/h.

Application

In rooms and windows of all kinds in domestic applications as well as in small to mid-sized commercial rooms.

Special specifications and common details

Universal operation

Prepared for single pane, insulation and double glazed window installation as standard (HR 90 KE/FES not for hinged coupled windows). Suitable for wall installation with wall plugs (accessories) and dowels.

Electrical internal shutter

Quietly closes tight when fan is off; maintenance free. Automatic operation together with fan.

Casing

Made from high quality, impact resistant polymer. Fan casing and outside grille in pleasant white.

Motor

Totally enclosed motor in a splash proof casing. Maintenance free and interference-free. Maximum air flow temperature +40 °C.

Installation

Unit construction allows a fast installation with only a few fixings giving quick installation and easy servicing.

Accessory details Page

Speed controllers, switches and overrun timer 525 on

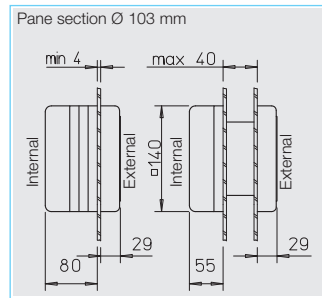

Specification HR 90 KE/FES

- Elegant, small window fan for all rooms. The innovative design effectively prevents the view of the interior zone of the fan.
- For installation in single panes and double glazed windows with a thickness of 4 – 40 mm. The variable distances can be compensated for using a combination of the supplied frames.
- Wall termination through a flat rain repellent grille.
- Controlled by built-in pull cord or by on/off switch installed locally
- Integrated operation display.
- Protection to IP 45.

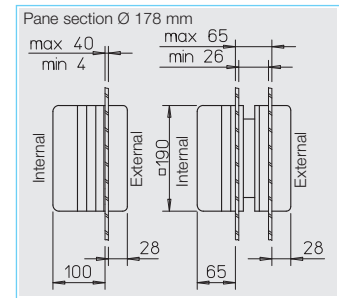

Specification HVR 150/FES

- Powerful window fans for small to mid-sized private and commercial rooms.
- For installation in single pane and double glazed windows (double glazed windows can be opened unhindered) as well as thin panellings with a thickness of 4 – 40 mm. The variable distances can be compensated for using a combination of the supplied frames.
- Wall termination through a flat rain repellent grille.
- Controlled by built-in pull cord or by on/off switch installed locally.
- Optical operation display.
- Protection to IP 44.

Delivery range			
Technical data	HR 90 KE/FES	HVR 150/2 E/FES	HVR 150/2 RE/FES
Ref. no.	0334 / 0462	0285 / 0463	0286 / 0463
Built-in electric shutter	Yes	Yes	Yes
Air flow reversible	Extraction	Extraction	DSEL 2 ²⁾ Ref. no. 1306
Window hole Ø mm	103 mm	178 mm	178 mm
Air flow volume (FID) m ³ /h	80	260	360
Impeller Ø mm	93 mm	140 mm	140 mm
Voltage 230 V, 50 Hz, Power consumption W	17	35	50
Current A	0.12	0.15	0.25
R.P.M. min ⁻¹	2550	1800	2600
Sound pressure/sound power level in dB(A) ¹⁾	44 / 51	58 / 65	64 / 71
Weight approx. kg	1.0	1.9	2.0
Wiring diagram no.	483	283	284
Accessories			
Double glazed installation for separable windows	—	included	included
Ref. no.	—	—	—
Wall installation, using wall tube 260 – 500 mm	TWH 90	TWH 150	TWH 150
Ref. no.	6352	6354	6354
Speed controller flush/surface	—	ESU 1 / ESA 1	ESU 1 / ESA 1
Ref. no.	—	0236 / 0238	0236 / 0238
Speed controller with included reversing switch for intake and extraction	—	—	BSX
Ref. no.	—	—	0240

¹⁾ Distance at 1 m in freefield conditions

²⁾ NYM-O 3 x 1.5 mm² cable required for reverse operation

Quiet window fans for operation in domestic, commercial and industrial applications. The GX range with quiet performance and safe for continuous operation. Fan and grille in white. Pleasant design, for use in every room of the house and facia.

■ Application

For ventilation of mid-size to large rooms of every kind in temperature ranges from -40 °C to +40 °C.

■ Special specifications

□ Universal operation

For installation in single pane, insulation and double glazing windows. Even suitable for installation in thin panel walls or solid walls.

□ Shutter operation

The shutter behind the fascia closes tightly and is quiet in operation. With an option that allows a permanent opening (passive ventilation in summer) even when fan is switched off. Shutter operates automatically with fan operation.

□ Casing

Made from high quality, white impact resistant polymer in a pleasant design. Fascia and impeller can be removed for cleaning (using soapy water) easily with one hand. The power supply will cut off automatically).

□ Motor

Totally enclosed, splash proof motor (IP 44) with thermal overload protection. Maintenance free and interference-free. Maximum air flow temperature +40 °C. Speed controllable by speed controller (accessory).

□ Installation

Unit construction, with only a few fixings giving quick installation and easy servicing.

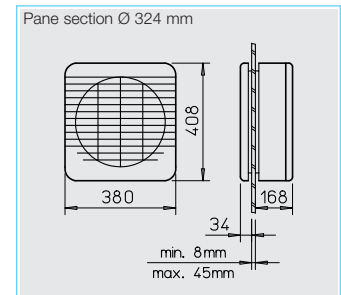
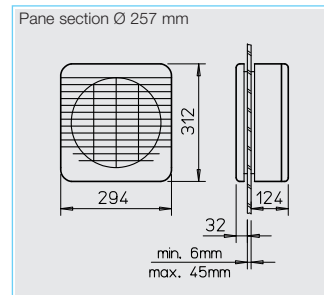
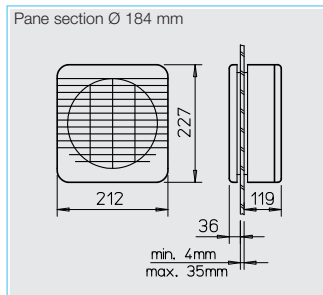

■ Specification GX 150

- Sophisticated fan for smaller sized rooms.
- For installation in single pane and double glazed windows, using an accessory for fixed and separable double glazed windows.
- Flat, external rain guard does not obstruct blinds or shutters.
- Service and installation friendly. Casing parts on the room side can be removed for cleaning without tools.
- Shutter function can be switched on for passive ventilation (without fan operation).
- Speed controllable by speed controller (accessory).

■ Specification GX 225

- Medium performance class fan with high comfort and integrated switch that allows following operations without changing the wiring:
 - Extraction
 - Input ventilation or
 - Reversed operation through external on/off switch/speed controller (accessory).
- Shutter function can be switched on for passive ventilation (without fan operation).
- Controllable by on/off switch (to be installed on site) or by on/off switch/speed controller (accessory). Automatic shutter operation with fan operation.
- Flat rain guard does not obstruct blinds or shutters.
- Service and installation friendly. Casing parts on the room side can be removed for cleaning without tools.

■ Specification GX 300

- Powerful fan for ventilation and extraction of larger rooms in an attractive soft line design. Suits any room in the house.
- Integrated switch that allows following operations without changing the wiring:
 - Extraction
 - Input ventilation or
 - Reversed operation through external on/off switch/speed controller (accessory).
- Controllable by on/off switch (to be installed on site) or by on/off switch/speed controller (accessory). Automatic shutter operation with fan operation.
- Static ventilation, installation and outer cover see GX 225.
- Unit construction, with only a few fixings giving quick installation and easy servicing.

■ Accessory details Page

Speed controllers, switches and overrun timers	525 on
--	--------



Model range	GX 150	GX 225	GX 300
Technical data			
Ref. no.	1483	1484	1485
Built-in electric shutter	Yes	Yes	Yes
Reversed operation	No	Yes	Yes
Window hole Ø mm	184 mm	257 mm	324 mm
Air flow volume free discharge m ³ /h	250	670	1650
Impeller Ø mm	150	225	300
Power consumption Watt	37	45	125
Voltage, 50 Hz	230 V	230 V	230 V
Current A	0.3	0.3	0.7
R.P.M. min ⁻¹	1250	1250	1250
Sound pressure ¹⁾ /power dB(A)	45/52	54/61	61/68
Weight approx. kg	2.5	4.0	7.0
Wiring diagram no.	508	538	538

¹⁾ in 1 m freefield conditions ²⁾ with reversing switch ³⁾ with 2 speeds and reversing switch

Window fan accessories			
Type	GX 150	GX 225	GX 300
Installation kit - double glazed windows			
- for fixed windows	DR 150 ⁴⁾	DR 225 ⁴⁾	DR 300 ⁴⁾
Ref. no.	5114	5115	5116
Wall kit			
- worm drive clips, 50 cm long	SB 50/2	SB 50/3	SB 50/4
Ref. no.	1385	1386	1387
- using wall tube	KR 150 ⁵⁾	WER 225/250 ⁶⁾	WER 300 ⁷⁾
Ref. no.	5091	0369	0469
Electronic speed controller flush/surface	ESU 1/ESA 1	ESU 1/ESA 1	ESU 1/ESA 1
Ref. no.	0236/0238	0236/0238	0236/0238
Electronic speed controller ²⁾ surface	—	BSX	BSX
Ref. no.	—	0240	0240
On/off switch ²⁾ flush	—	DSEL 2	DSEL 2
Ref. no.	—	1306	1306
On/off switch ³⁾ surface	—	FR 22/30	FR 22/30
Ref. no.	—	0998	0998

⁴⁾ Space rings for underpin 2-35 mm (1 set = 10 pcs.)

⁵⁾ 330 mm long ⁶⁾ 170 - 500 mm long ⁷⁾ 170 - 450 mm long

■ **Ceiling fan**

For cooling in summer, for energy saving in winter. For versatile use e.g. to move air for cooling or energy saving in mid size to large rooms as well as reception and waiting halls, restaurants, disco's, boutiques, wholesale retail outlets, assembly plants, warehouses, tennis and sport halls as well as for industrial drying applications.

Traditionally ceiling fans are used during summer for cooling. Where there are rooms without windows and high heat emission of lamps, ceiling fans solve ventilation problems in many areas. Decorative replicas in "Casablanca" design make Helios ceiling fans an attractive addition to any room.

During the heating period, ceiling fans can be used for energy saving by returning the hot air at the top of the room to the occupied space. In high rooms like sport halls, tennis halls and other industrial halls, slow spinning ceiling fans provide a draft free equal distribution of warm air within the room. This achieves an increase in temperature at the floor level areas of approx. 25% without any additional heating. The energy consumption is negligible. Reference projects which have been running for many years achieved an average temperature increase of 4 °C at the floor level.

DVW 90



DVAW 130

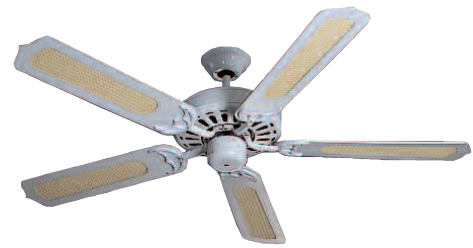

DVW 140



DVAM 130

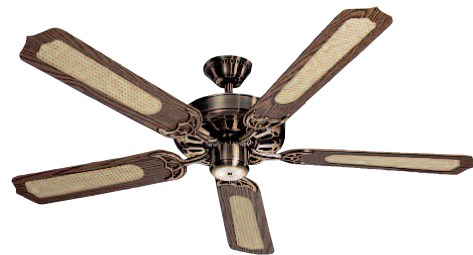

■ **Ceiling fans DVW range**

- Robust metal version in classic design.
- Totally enclosed motor, maintenance free and interference-free.
- Resilient mounting ensures low vibration.
- Simple installation, pre-assembled motor and fixings. Only blades need to be fixed.
- Variable suspension height through delivery of long and short pendant tube.
- Speed controllable via 5 speed transformer TSW 0.3 (accessory).
- Reversible air flow direction. Air flow direction to floor or to ceiling by wiring connection or through reversing switch (accessory DSEL 2). In case of reverse operation (upward air flow direction), minimum starting voltage of 100 V required.

■ **Ceiling fans DVA range**

- In typical "Casablanca" design for installation in more decorative areas.
- Casing made from brass, finished in antique brown or white. Five wooden blades with a wicker finished in nut brown or white. Maintenance free, long life, slot-vented motor with ball bearings for permanent operation.
- Resilient mounting ensures low vibration.
- Simple installation directly to ceiling or on short pendant tube (part of delivery).
- Pull cord for three speed on on/off operation. Suitable for connection to remote speed controllers (accessory).

■ **Fan selection**

Impeller diameter, position and mounting height are important parameters during design to allow equal coverage of air flow within the room. The room height less the down rod equals the mounting height of the fan. In relation to height and impeller diameter the diagram below shows the area covered by each fan in m². The distance from the fan's centre to the wall should equal approximately 3 times the impeller diameter. The distance from the fan's centre to the fan's centre (when using several fans) should equal approximately 6 times the impeller diameter. We recommend operation at high speed during summer (cooling) and at low speed in winter (energy conservation).

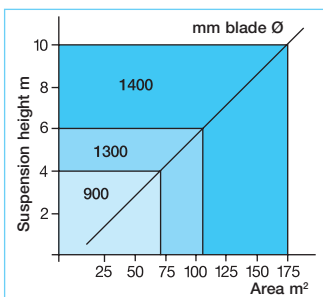

■ **Accessories for DVW and DVA**

Speed controller
Type TSW 0,3 Ref. no. 3608
 Five step transformer with on/off function for surface installation.

Energy saving automatic controller
Type EDTW Ref. no. 1613
 Varies fan speed automatically in accordance to the temperature difference between high level and low level sensor. Specially for operation in winter for energy saving.

■ **Important installation information**

Safety regulations ask for a minimum distance of 2.3 m from the bottom of the blades to the floor. Fans should be installed so that they do not interfere with other equipment.

Order and technical information				
Type	DVW 90	DVW 140	DVAW 130	DVAM 130
Ref. no.	8648	8649	8650	8651
Impeller Ø mm	900	1400	1300	1300
Number of blades	3	3	5	5
Voltage / Frequency	1~, 230 V / 50 Hz	1~, 230 V / 50 Hz	1~, 230 V / 50 Hz	1~, 230 V / 50 Hz
Current A	0.26	0.30	0.29	0.29
Power consumption W	50	75	66	66
Maximum R.P.M. min ⁻¹	340	270	220	220
Suspension height min./max. mm	440/565	460/585	220/360/510	220/360/510
Sound pressure level dB(A) in 4 m	35	44	29	29
Weight approx. kg	4.8	6.8	6.7	6.7

First class in design and quality.



The Helios heater range includes mobile and stationary devices for various space heating and ventilation applications. Application is almost unrestricted, even in wet and damp areas.

Advantages of electric heaters

- Economical to run.
- Low-cost investment.
- Simple installation.
- No capacity costs.
- Ready for immediate operation.
- No performance losses.
- Odourless and emission-free.
- Chimney connection not required.

Area of application

1. Transitional/additional heating in workshops, warehouses, offices, etc.
2. Full heating for large rooms which are only used periodically, such as churches, gyms, meeting rooms, among others.
3. Site heating for room heating and space drying.
4. Frost protection heating to prevent freezing temperatures in frost sensitive rooms, such as warehouses, waterworks, pump stations, among others.
5. Drying and condensation prevention in rooms of all kinds in commercial and industrial applications.

Desired temperature increase	Required heat power in kW					
	3 kW	5 kW	10 kW	15 kW	20 kW	30 kW
40 °C	75*– 100	125*– 175	250*– 350	375*– 500	575*– 800	850*– 1200
35 °C	90*– 120	150*– 200	300*– 400	450*– 600	690*– 900	1000*– 1300
30 °C	100*– 150	175*– 250	350*– 500	500*– 750	800*– 1150	1200*– 1700
25 °C	120*– 180	200*– 300	400*– 600	600*– 900	920*– 1380	1550*– 2000
20 °C	150*– 210	250*– 350	500*– 700	750*– 1050	1150*– 1600	1750*– 2400
15 °C	200*– 280	340*– 470	680*– 940	1000*– 1400	1550*– 2150	2300*– 3200
10 °C	300*– 420	500*– 700	1000*– 1400	1500*– 2100	2300*– 3200	3500*– 4800
5 °C	600*– 800	1000*– 1400	2000*– 2800	3000*– 4200	4600*– 6400	6900*– 9600

* Figures for poor room insulation. Fast heating on occasional operation requires double the heat power.

Project planning and selection

The table on the left considers the following to calculate the required heat power:

- Desired room temperature or difference to outside temperature.
- Room size in m³,
- Room or building insulation.

Example: Main heating

Room volume: 600 m³.
Desired temperature: +20 °C.
Lowest outside temperature: –15 °C.
Insulation: Good.
The desired temperature increase of 35 °C results in a required heat power of 15 kW.

STH / TH



The compact, powerful STH fan heaters are reliable, robust and well-equipped.

They are suitable for heating and drying.

Application on building sites, in production facilities, warehouses and workshops, churches, meeting rooms, among others.

- Series with heating power of 3 kW: 1~, 230 V and 5, 9, 15, 22 kW: 3~, 400 V
- Practical handling due to compact dimensions.
- Attractive design.
- Easy to lift, transport and hang up through ergonomically designed, stable transportation frame.

Quality in every detail

- Robust, resistant and secure due to metal body. Suitable for use under the roughest conditions even in wet areas, as well as for permanent operation.
- Corrosion resistant casing, made from galvanised sheet steel, powder coated in pleasant white.
- Red powder coated tripod, protecting all sides.
- Stable front protection grille, powder coated in grey.
- Clearly arranged control board, protected against damage through recessed position.
- Maintenance free and interference-free.
- All models with protection to IP X4. Suitable for use in wet areas.
- Contact safety to DIN EN 60335.
- Enclosed heater element made from high-grade stainless steel with low surface temperature.

- Easily accessible, from outside resettable overheat protection for types STH 9 T, STH 15 T and TH 22 T. For STH 3 and STH, self resetting after cooling down.

Individual timer

All types from 9 kW on have a digital timer for preprogrammed operation up to 24 hours at set room temperature as standard.

Control

Via built-in operation switch.

- Heating for types with 3, 5 and 9 kW, two stages available; for type with 15 and 22 kW, three stages available.
- Heating operation through built-in room temperature thermostat, adjustable from +5 °C to +35 °C. Fan keeps operating for better heat distribution when heating is switched off.

Dimensions in mm

Type	A	B	C	D
STH 3 / STH 5	295	380	350	460
STH 9 T	360	450	420	520
STH 15 T	415	475	330	535
TH 22 T	540	615	560	

STH 3, STH 5, STH 9 T

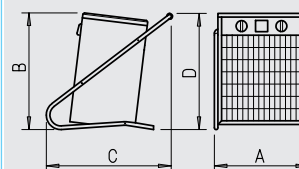

STH 15 T

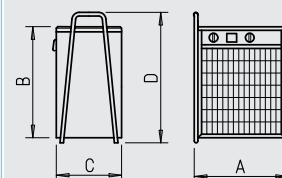

TH 22 T

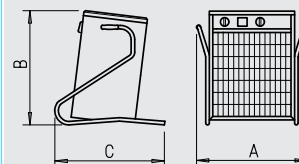

Dim. in mm

Technical data					
Type	STH 3	STH 5	STH 9 T	STH 15 T	TH 22 T
Ref. no.	2520	2521	2522	2523	2524
Heat power kW	3.0	5.0	9.0	15.0	22.0
Controllable heat power kW	0 – 1.5 – 3	0 – 2.5 – 5	0 – 4.5 – 9	0 – 5 – 10 – 15	0 – 7 – 15 – 22
Max. temperature increase K	25	37	38	35	27
Max. surrounding temperature °C	40	40	40	40	40
Air flow volume m³/h	400	400	700	1300	2400
R.P.M. min ⁻¹	1300	1300	1300	1300	1180
Sound press. dB(A) in 4 m (free field)	40	40	43	58	65
Voltage V, 50 Hz	1~, 230	3~, 400	3~, 400	3~, 400	3~, 400
Current A	13.5	7.5	13.5	21.7	31.5
Socket / CEE coupling required	1)	16 A	16 A	32 A	32 A
Weight approx. kg	6.0	6.0	10.5	15.5	24.0
Timer function (pre-programming 24 h)	—	—	Yes	Yes	Yes

1) with approx. 1.5 m long cable and shockproof plug

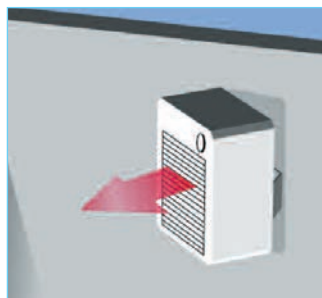

- The SH types can be used everywhere: In workshops, warehouses, gyms, entrance halls, business premises, meeting rooms and store-rooms, in churches and even in wet rooms. Models are available with 6, 9, 12 or 15 kW.

■ Significant features

- Particularly quiet due to low-noise fan impeller.
- Corrosion resistant casing made from galvanised sheet steel, powder coated in pleasant white.
- Stable front protection grille, powder coated in grey.
- Maintenance free and interference-free.
- Service friendly design: All parts are easily accessible by removing a few screws.
- Enclosed heater element (non-glowing) from stainless steel.

■ Design

- Easy setting of air flow volume required for the room conditions via 3 fan speeds.
- Single step capillary tube thermostat (setting range +5 to +40 °C) controls the heat output via temperature sensor to raise the temperature from the incoming to the desired value.
- Operation switch to control fan speed and heat power as standard for surface installation.

■ Installation

Series SH can be individually mounted to any wall. The air flow can be directed alternatively to the front, diagonally to the left, right or downward through the assembly-friendly suspension device fixed to the unit.

■ Operation switch

delivered as standard – with the functions: On, Off, 3 fan speeds, 100% and 50% heating power. Installed in any position.

■ High operation safety

- Meets safety requirements EN 60335-2-30.
- Thermal overheat protection with manual reset.
- Enclosed heater element with low surface temperature.
- Spray water protected design (IP 44) for operation in wet areas.
- Fan motor with thermal overload protection (IP 44).
- Protection against contact to DIN EN ISO 13857.



Technical data				
Type	SH 6	SH 9	SH 12	SH 15
Ref. no.	5225	5226	5227	5228
Heat power kW	6	9	12	15
Controllable heat power kW	0 – 3 – 6	0 – 4.5 – 9	0 – 6 – 12	0 – 7.5 – 15
Temperature increase K				
– at maximum speed (stage 3)	7 – 14	11 – 21	11 – 22	13 – 26
– at medium speed (stage 2)	10 – 20	15 – 30	12 – 24	15 – 30
– at minimum speed (stage 1)	14 – 29	22 – 44	15 – 30	11 – 37
Air flow volume m ³ /h				
– Speed step 3	1300	1300	1700	1700
– Speed step 2	900	900	1550	1550
– Speed step 1	630	630	1220	1220
Sound pressure in dB(A) at 4 m (free field conditions)				
– at maximum speed	46	46	51	51
– at minimum speed	32	32	44	44
Voltage V, 50 Hz	3~, 400	3~, 400	3~, 400	3~, 400
Current A	9	14	18	22
Required supply line mm ²	4 x 2.5	4 x 2.5	4 x 6.0	4 x 6.0
Socket / CEE coupling required	16 A	16 A	32 A	32 A
Control line	6 x 0.75	6 x 0.75	6 x 0.75	6 x 0.75
Wiring diagram no.	858	858	858	858
Weight approx. kg	19	19	26	26

Dimensions in mm				
Type	A	B	C	D
SH 6	400	490	310	460
SH 9	400	490	310	460
SH 12	450	560	415	585
SH 15	450	560	415	585

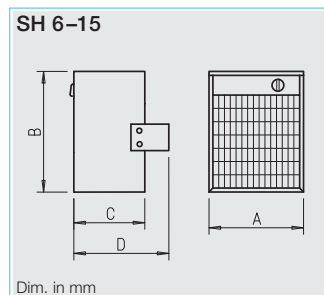

Helios: The systems provider in controlled residential ventilation.

MOISTURE PROTECTION



Traditional residential ventilation by opening the windows is not a valid solution these days. Studies have shown that ventilation is only insufficient and uncontrolled in 80% of cases. This destroys the energy savings strived for by the extensive insulating measures. Efficiency, sealed building shells and the ventilation concept for damp and moisture protection require increasingly mechanised, controlled ventilation.

COMFORTABLE CLIMATE



Odours from the kitchen, bathroom and WC as well as harmful substances from cleaning agents, furniture, etc. have to be led away for a comfortable, healthy indoor atmosphere. The moisture caused by cooking, drying and showering – an average of 10-15 litres of water per day in a 4-person household – has to be run outside in order to prevent mould, stains and damp walls.

HEALTHY AIR



Helios has optimal systems for all areas of application, be it with or without heat recovery, for a new build or renovation, multi-storey building or detached house, as a centralised or decentralised solution. Tailored and coordinated accessories round off the corresponding ventilation devices. The requirements of the Energy Saving Ordinance (EnEV) are met in full and fire and noise safety concerns are covered.

Controlled residential ventilation systems at a glance.

PLANNING INFORMATION
DIN 1946-6
DIN 18017-3

44

MULTI-STOREY CONSTRUCTION



MONO TUBE VENTILATION SYSTEM ELS
with individual devices according to DIN 18017-3

46^{on}



CENTRAL VENTILATION SYSTEM ZLS
with energy-saving EC roof fan according to DIN 18017-3

65^{on}

SINGLE FAMILY HOUSES APARTMENTS

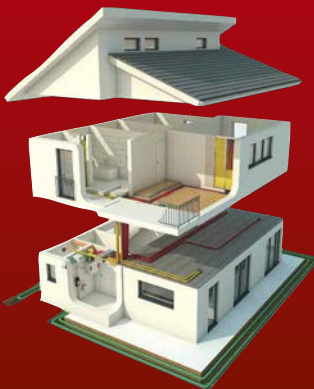

CENTRAL VENTILATION BOX ZEB

70^{on}

KWL® VENTILATION SYSTEMS
with heat recovery

76^{on}

KWL® PERIPHERY

- HygroBox
- Ground heat exchanger
- Air distribution systems
- Air inlets and outlets
- Wall / roof outlets, etc.

114^{on}

■ **Ventilation concept (LK) according to DIN 1946-6**

□ The requirements of the Energy Saving Ordinance (EnEV 2016) for residential buildings prescribe that a minimum user-independent circulation of air in the residential unit must be guaranteed for quality assurance and building protection. For this reason, a ventilation concept is to be created according to DIN 1946-6 for every new build and all energy-oriented refurbishments. The ventilation concept answers the planning issue of whether a residential building is sufficiently ventilated by natural infiltration (building leaks) or whether user-independent ventilation measures are required.

■ **Method:**

1. Calculating the air flow volume for moisture protection according to DIN 1946-6; 05/2009

$$q_{v,ges,NE,FL} = f_{WS} \cdot (-0,001 \cdot A_{NE}^2 + 1,15 \cdot A_{NE} + 20)$$

$q_{v,ges,NE,FL}$ = air flow vol. for moisture prot. m³/h
 A_{NE} = Surface area of the residential unit in m²
 f_{WS} = Factor to consider the building's heat insulation.
 0.3 for high insulation (building with insulation according to the German Heat Conservation Ordinance (WSchV) 95 or better).
 0.4 for low insulation (building with insulation worse than WSchV 95).

2. Calculating the air flow volume by infiltration according to DIN 1946-6; 05/2009

$$q_{v,Inf,wirk} = f_{wirk,Komp} \cdot A_{NE} \cdot H_R \cdot n_{50} \cdot (f_{wirk,Lage} \cdot \frac{\Delta p}{50})^n$$

$q_{v,Inf,wirk}$ = effective air flow vol. by infiltration m³/h
 $f_{wirk,Komp}$ = Correction factor for deducible system-independent and component-independent infiltration according to DIN 1946-6 Tab. 8, exact calculation according to the calc. method outlined in DIN 1946-6 Annex I. Standard val. 0.5 (taken as a basis to simplify the determination of ventilation tech. measures within the ventilation concept for free ventilation in the form of cross ventilation).
 A_{NE} = Surface area of the residential unit in m²
 H_R = Room height in m
 n_{50} = According to DIN 1946-6 specifications or measured values. See table 1.
 $f_{wirk,Lage}$ = Correction factor for the effective proportion of air from infiltration as a factor of the building location. Standard value 1.0, exact calculation according to the method outlined in DIN 1946-6 Annex I.
 Δp = Differential design pressure
 For single-storey residential units: for areas with little wind 2 Pa, for areas with strong wind 4 Pa.
 For multi-storey residential units: for areas with little wind 5 Pa, for areas with strong wind 7 Pa.
 n = Press. exponent, stand. val. $n = 2/3$ or measured val

3. Air flow volume balancing

Following the calculation of both air flow volumes $q_{v,Inf,wirk}$ and $q_{v,ges,NE,FL}$ the two values are compared. If the air flow volume from infiltration is less than the air flow volume for moisture protection, ventilation technology is required. The selected ventilation technology (e.g. Helios DV

EC, ultraSilence® ELS, KWL®) must permanently transport the air flow volumes for moisture protection and must be user-independent (24 hours a day / 365 days a year).

For the further design of a residential ventilation system, it is not only the air flow volume for moisture protection that is relevant, but also the air flow volume needed to fulfil and maintain the minimum hygienic requirements, which must also largely be ensured independently of the users.

■ **Forms of ventilation / operating modes according to DIN 1946-6**

□ **Ventilation for moisture protection (FL)**

Ventilation required to ensure the protection of the building (against moisture) under normal conditions of use with reduced moisture loads in some cases. Example: Normal conditions of use with reduced moisture loads in some cases include, for example, temporary absence of the users and no drying of washing in the residential unit.

Operating mode:

Continuous (24 h/365 d); user-independent

□ **Reduced ventilation (RL)**

Ventilation necessary to ensure the min. hygienic requirements and for the protection of the building (against moisture) under normal conditions of use with reduced moisture loads and subst. concent. in some cases. Example: As a result of the temporary absence of users.

Operating mode:

Continuous (24 h/365 d); user-independent

□ **Nominal ventilation (NL)**

Ventilation necessary to ensure the min. hygienic requirements and for the protection of the building when the users are present (normal operation).

Operating mode: Primarily when users are present; time limited for energy-related reasons; ensured by suitable ventilation technology with temporary support from free ventilation (window ventilation).

□ **Intensive ventilation (IL)**

Temporarily required ventilation with increased air flow volume of air to decompose load peaks (load operation).

Operating mode: Primarily when users are present; time limited for energy-related reasons; ensured by suitable ventilation technology with temporary support from free ventilation (window ventilation).

Table 1: Standard values of design air exchange according to DIN 1946-6

House type	Standard	Ventilation system	n ₅₀ value
Single-storey unit (EFH)	New build	Fan-supported ventilation	1.0
Single-storey unit (EFH)	Renovation	Fan-supported ventilation	1.0
Multi-storey unit (MFH)	New build	Fan-supported ventilation	1.0
Multi-storey unit (MFH)	Renovation	Fan-supported ventilation	1.0
Single-storey unit (EFH)	New build	Free ventilation	1.5
Single-storey unit (EFH)	Renovation	Free ventilation	1.5
Multi-storey unit (MFH)	New build	Free ventilation	1.5
Multi-storey unit (MFH)	Renovation	Free ventilation	2.0

(EFH) = Single family house / (MFH) = Apartment building

■ **Subs. supply of outside air**

A residential ventilation system according to DIN 1946-6 means that a corresponding air flow volume of supply air is subsequently supplied in the amount of the exhaust air flow volumes using suitable outside air vents (ALD) dimensioned according to DIN 1946-6.

Determining the number of outside air vents required in the building shell:

$$n_{ALD} = (q_v - q_{v,Inf,wirk}) / q_{v,ALD}$$

n_{ALD} = Number of outside air vents
 q_v = Air flow vol. of exhaust air per residential unit
 $q_{v,Inf,wirk}$ = Air flow volume from infiltration per residential unit
 $q_{v,ALD}$ = Air flow volume per outside air vent

■ **Noise protection**

DIN 4109 has been established under construction law and governs the noise protection requirements for the building (public/private). In the case of designs according to VOB and terraced or town houses, they must be observed as minimum requirements. They may be agreed for detached house. VDI Directive 4100 has not been established under construction law, but is often regarded as the state of the art. VDI 4100 distinguishes between two levels of noise protection (see table 2).

Framework conditions

The noise levels stated in DIN 4109 can technically be achieved if targeted boundary conditions are observed, such as:

- Manhole arrangement during floor planning
- Design of the installation walls and/or manholes in 220 kg/m³
- Isolation from the main structure
- Determining the noise protection requirements
- Inclusion of an acoustics technician from noise protection level (SSt) III according to VDI 4100
- Contractual safeguarding and determination of the standard principles

Recommendation:

In the case of buildings under private law, it must be defined in advance whether the building is designed according to DIN 4109 or VDI 4100.

■ **Note**

In the case of buildings under private law, it must be defined in advance whether the building is designed according to DIN 4109 or VDI 4100.

www.KWLeasyPlan.de

Table 2: Noise limits (DIN 4109-1)

Sound source	Type of room requiring protection	
	Living rooms, bedrooms	Classrooms, workspaces
Sound pressure level dB (A)		
Water installations (both water supply and wastewater systems)	$L_{In max} \leq 30^a$	$L_{In max} \leq 35^a$
Other building service installations	$L_{AF max} \leq 30^b$	$L_{AF max} \leq 35^{b*}$
Operation	day 6 to 22 hrs	$L_r \leq 35$
	night 22 to 6 hrs	$L_r \leq 35$

^a Individual short-term peaks when operating the fittings and devices according to Annex B, Table B.1 (Open, close, adjust, interrupt) should be disregarded.

^b With regard to ventilation systems, values which are 5 dB(A) higher are permitted, provided this concerns continuous sounds without any individual tones.

* Unless higher level due to increased intrinsic noise generation is acceptable.

■ **DIN 18017-3 (white paper 09.09) is the recognised state of the art for the planning and installation of ventilation systems in bathrooms and toilets without external windows. Rooms of this kind are widespread in existing multi-storey buildings and are also regularly found in apartment building projects.**

DIN 18017-3 essentially relates to the removal of air from indoor bathrooms and toilets, meaning that it concerns exclusively single rooms. This is in contrast to DIN 1946-6, which relates to the ventilation of apartments in general and therefore considers the entire unit. When planning and implementing the exhaust air system, the first thing to do is to decide whether it relates to a residential or non-residential building.

■ **Process for residential buildings**

Be it a detached house or apartment building, a new build or renovated property, the start of the approach to ventilation technology is the ventilation concept called for by DIN 1946-6. The user-dependent, permanent guarantee of ventilation for damp and moisture protection has specific impacts on the concept design of the exhaust air system.

- The requirements for exhaust air flow volume in accordance with DIN 18017 make a distinction based on the question of whether the air extraction is to be permanent (40 m³/h) or demand-based (60 m³/h). In the case of demand-based systems, the air flow volume may be reduced to 0 in times of low demand for air. Continuous ventilation to protect against moisture, as prescribed in DIN 1946-6, is not stipulated. This means that in two-level ventilation devices are used in exhaust air systems in residential buildings. The basic level (30 m³/h) is connected to the continuous current and cannot be turned off by the user. This therefore sufficiently satisfies the demand for the fan to provide damp and moisture protection. The higher level (60 m³/h or 100 m³/h) is activated according to demand. It is activated when switched on by the user or through moisture/presence control.
- In order to ensure the suitability of an exhaust air system for function also in the case of modern and therefore sealed building shells, the planning and construction of are outdoor air vents are indispensable. The air flow volume of the exhaust air is

to be offset by an equal air flow volume of incoming air through the building shell through suitable outdoor air vents. The infiltration through the building shell previously calculated in the ventilation concept is deducted when determining the dimensions of the ALD.

- In the case of a renovated property, it should be clear to all those involved in the project that the presence of a exhaust air ventilation system in accordance with DIN 18017-3 does not relieve them from their obligation to create and adhere to a ventilation concept according to DIN 1946-6. The air flow volume for damp and moisture protection must in principle be guaranteed. In addition, it is necessary that an air flow volume of incoming flow equal to the total of the air flow volume of exhaust air is continuously passed through the building shell. If the total exhaust air flow volume is smaller than the air flow volume required for damp and moisture protection, the exhaust air ventilation system is to be adjusted at least to the damp and moisture protection air flow volume.

■ **Planning guidelines for exhaust systems**

Building a new residential property:

- Creation of a ventilation concept in accordance with DIN 1946-6
- Design of the controlled ventilation and air extraction in accordance with DIN 1946-6
- Integration of at least two-level individual room fans to ensure ventilation for damp and moisture protection and the air flow volumes required under DIN 18017. Ensuring the supply of further incoming air by selecting suitable outside air vents.

Renovation of a residential property:

- Creation of a ventilation concept in accordance with DIN 1946-6
- Comparison of the exhaust air flow volumes present on-site with the minimum air flow volume for moisture protection
- Retrofitting suitable outdoor air vents, where necessary
- Substitution of the existing single-phase individual room fans by multi-level appliances.

■ **Process for non-residential buildings**

DIN 18017-3 continues to apply beyond its normal scope for the ventilation of interior WCs and other exhaust air rooms in non-residential buildings. In contrast to residential buildings, there are no normative obligations of any kind to ensure ventilation for

damp and moisture protection in non-residential buildings. The need for ventilation technology in WCs in particular is governed by the Workplace Ordinance and other construction law guidelines. The requirements of the standard can be adopted unchanged for ventilation systems in non-residential buildings planned and built in accordance with DIN 18017-3.

■ **Types of system**

- The individual exhaust air ventilation systems are further divided into systems with their own exhaust air duct and systems with a shared exhaust air duct. Due to the numerous benefits (e.g. space-saving by having just one duct), systems with shared exhaust air duct are given preference in practice.
- The central ventilation systems are also divided into two sub-categories: Central ventilation systems with air flow volume that can only be changed jointly and central ventilation systems with air flow volumes that can be changed in each apartment (e.g. DV EC in combination with AE exhaust elements).
- Pure ventilation of individual rooms is within the scope of DIN 18017-3. If there are no requirements on the ventilation technology of any kind in the project within the meaning of DIN 1946-6, the following planned air flow volumes shall apply:
 - 40 m³/h in central ventilation systems
 - This air flow volume is to be discharged permanently.
 - However, the exhaust air flow volume must not be reduced by more than half for more than 12 hours a day in times of low demand for air, particularly at night.
 - 60 m³/h for decentralised exhaust air systems
 - This air flow volume of exhaust air is to be led away during use in the case of demand-based systems.
 - The ventilation appliance may be reduced to 0 in times of low demand for air if the building complies with a thermal insulation standard under the 1995 Heat Insulation Ordinance or better.
 - The same air flow volumes apply for kitchens.
 - In the case of pure WC rooms, these air flow volumes can be halved.

■ **Instructions for project planning**

The primary exhaust air duct should be straight and vertical and must have an even cross-section, otherwise mathematical proof in accordance with DIN 18017-3 is required. The primary

exhaust air duct is to be equipped with heat insulation in order to prevent the formation of condensation. Alternatively, condensation drains may be installed.

- Exhaust air can be carried away from bathrooms and WCs by a fan. To that end, a double direction valve set can be used.
- Exhaust air can be carried away from bathrooms and kitchens via separate fans. The connection of extractor hoods to DIN 18017-3 systems is not permitted. To that end, built-in lines must be planned.
- The exhaust lines are to be permanently sealed and must have a stable design. A sufficient number of suitable cleaning openings are to be provided. Screw-in openings for cleaning are not permitted.

■ **Project planning characteristics for central ventilation systems**

- For central ventilation systems with an air flow volume that can only be changed for all apartments, only exhaust valves with the same characteristic curve can be used. It must not be possible to adjust the valves after adjustment. Systems of this kind are to be operated permanently. Air flow volume reductions in times of low demand for air are to be triggered automatically (e.g. using a timer).
- Central ventilation systems with air flow volumes that can be changed for individual apartments have configurable exhaust elements with variable characteristic curves. The exhaust valves are activated by the user in the apartment or controlled automatically by room air sensors. The air flow volume is then only adjusted according to demand in the respective apartment. Air flow volume stabilizers built into the exhaust elements mean that other apartments remain unaffected by the change. The capacity of the fan adjusts automatically to the total air flow volume to be conveyed.

■ **Fire safety**

The fire safety of exhaust air systems in accordance with DIN 18017-3 is governed in the official ventilation system guidelines (MLüAR), section 7 "Specific conditions for ventilation systems in accordance with DIN 18017-3". All products licensed for this are marked with the label 18017-3 under building law and may only be used in such systems. Use of these fire safety products in other types of systems (e.g. ventilation systems in residential spaces with heat recovery) is not permitted.

Ventilation of sanitary rooms and apartment kitchens in accordance with DIN 18017-3.



The mono tube ventilation system ultraSilence® ELS from Helios has impressive benefits for the ventilation of interior bathrooms and WCs in residential units, hotels and other buildings prescribed by DIN 18017-3.

- **Space-saving:**
A central riser duct spanning more than 20 storeys with the smallest possible cross-section saves money and creates usable living space.
- **Cost-effective:**
Low material use and quick and easy installation result in manageable costs and time required.
- **Energy-saving:**
The ultraSilence® ELS devices reduce the need for ventilation heat and therefore contribute to energy-savings when it comes to heat.
- **Simple planning:**
Evidence of DIBt approval renders all further measurements in the construction sign-off superfluous to requirements, providing extra certainty and saving trouble. The effort for planning, rising duct dimensioning, tendering and specifications is reduced to a minimum.
- **Software-assisted:**
The entire planning is done at the click of a button with Helios ELS software. Lists of materials and offers are completed in just a few steps. Simply download it from www.heliosventilatoren.de.



EXTRACT AIR



The beautifully quiet ELS devices are turned on according to demand and guide used air out of the kitchen, bathroom and toilet via a central main line, which may be connected to more than 20 storeys or over 40 individual devices.

56^{on}

OUTSIDE AIR



External air vents quietly feed outdoor air without dust into bedrooms and living rooms. Helios offers elements that can be built into walls and windows, manually controlled or temperature-regulated, with automatic air flow volume adjustment and sound insulation.

61

FIRE SAFETY



When planning and designing ventilation systems, the state fire safety requirements must be observed. A number of different solutions are available to choose from, depending on the structural circumstances.

55^{on}



Revolutionary and intelligent:
ELS-VF types with automatic
humidity control for optimal en-
ergy saving and a comfortable
room climate without mould.
More on page 53.



Barrier-free and automatic.
ELS-VP with PIR sensor for au-
tomatic ventilation as required
when entering the room. Opti-
mum fan control ideal for toilets
and sanitary facilities of hotels,
offices, hostels, etc.
More on page 53.



Unique: Filter change display in-
dicates when filter needs clean-
ing. Permanent, long life, wash-
able filter with large cross sec-
tion area. Saves the purchase of
expensive disposable filters.



Flexibility without limits: Casing
types ELS-GU and -GUBA for
one/two room ventilation with
connection left, right, to the
bottom or for toilet adaptation.
Discharge spigot to the top,
rotatable to the left, right or to
the back.

The Helios ELS dimension.
Silent. Strong. Slim. Beautiful.



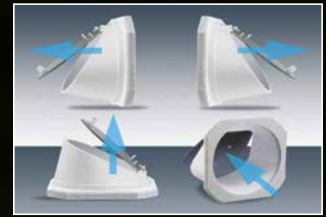

Clever: Airtight back draught shutter in the discharge spigot, can be turned by 90°. Permits casing positioning with discharge to the left, right, to the top or to the back.



Intelligent electronic system for wide variety of operating modes like interval function, overrun timer, humidity controlled operation, automatic PIR sensor etc. Circuit board with pins for electrical connection placed in splash proof casing.



Efficient energy-saving motor. Acoustically tested, long life ball bearings are greased for life (approx. 40 000 hours running). Maintenance free, totally enclosed in an aluminium diecast casing.



Optimal solution for every demand. More than 20 different ELS fan units can be assembled in the standard surface or flush mounted casing without using tools.



product design award
2008



Designpreis Deutschland 2010
NOMINIERT



red dot design award winner 2008



Design Center Stuttgart
Silber 2008

ultraSilence
by Helios

- Only 26 dB(A)*. Wonderfully quiet.

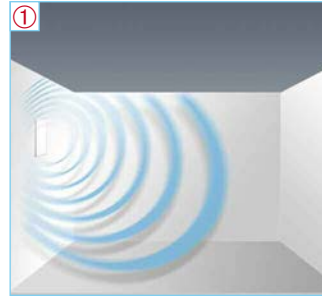

Above all in apartment construction, the ventilation must be virtually silent. This is fully achieved with the single ventilation units ultraSilence® ELS. With 26 dB(A)* for ventilation on the standard ventilation stage ($V=35 \text{ m}^3/\text{h}$) and 35 dB(A)* for $V=60 \text{ m}^3/\text{h}$ and $A_L = 10 \text{ m}^2$, ultraSilence® ELS unbeatably quiet.

The sound levels correspond to DIN 18017-3 as follows and are guaranteed by Helios:
 – sound power level, A-rated (L_{WA}) in dB(A) or
 – sound pressure level, A-rated (L_A) in dB(A) in relation to an absorption surface $A_L = 4 \text{ m}^2$. In relation to $A_L = 10 \text{ m}^2$, so ergethe sound levels are 4 dB(A) lower.

① The sound power level L_{WA} shows the real emitted sound power, independent from the distance and room conditions, and is the sound at source.
 ② The sound pressure level L_A is caused by the source and received by the ear. Depending on absorption, i.e. absorption capacity of the room, the perceived sound varies and is difficult to trace.

* According to DIN 18017-3: 2009-09, section 7.2.4. footnote 5.

- Exclusive. Permanent filter and filter change display.

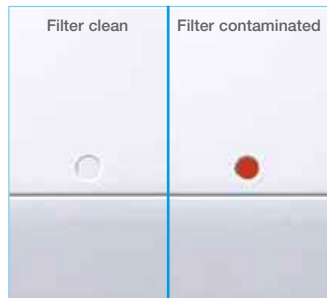

All ELS fan units have **permanent filters as standard**. This ensures trouble free quiet installation. They prevent the fan and sound insulation from becoming clogged, resulting in satisfied tenants, landlords and owners. The filter change display (red dot) indicates when the filter needs cleaning which prevents a drop in performance. Very practical!

User friendly – the retractable facia with hinge.
 For filter removal flip up facia by hand. To close simply let it retract.

Completely airtight.
 The all round flexible sealing prevents air inlet and dirt deposit along the wall/ceiling surface.

Unique – the permanent filter.
 Large filter cross-section area, with high dirt holding capacity for long cleaning intervals. To clean the filter, simply put it in the dishwasher: This eliminates the regular purchase of expensive disposable filters.

- Excellent design. Good-looking. Slim. Clean.



Perfectly designed and multiple award-winning.
 ultraSilence® ELS fits everywhere: The facia complements every tile, wallpaper or marble- and thus satisfies the highest demands of designers. The minimalist-designed ultra flat facia with classy look covers the fan unit. The air flows in on all sides so that dirt deposits are prevented.

The ultra flat premium design of the facade impresses in every room design with unobtrusive elegance. The extremely slimline flush mounted casing has an installation depth of just 89 mm. That way it integrates completely – also in small rooms, on walls or ceilings. The ideal solution, also in narrow installation shafts.



■ **Lightning fast installation.**

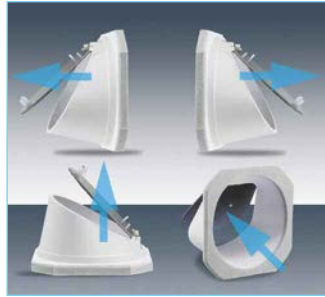

Clever. The airtight back draught shutter, which is integrated in the discharge spigot, can be turned by 90°. This makes a positioning of the casing with discharge to the left, right, top or back possible.



Unlimited possibilities. ELS-GU and -GUBA are the universal casings for one or two room ventilation with connection to the left, right or bottom as well as toilet seat adaptation via flushing pipe. The discharge spigot can be positioned to the top, left, right or to the back. Everything with the same casing!



So very simple – the electric plug connection. For trouble-free connection, removable from its fixture. Cable entry and connector connecting takes place with casing assembly. Insertion of fan unit and facia on final fix.

■ **Approved and tested.**



All casings and fan units approved by the DIBt with approval No. Z-51.1-193.

The ultraSilence® ELS units have the approval of the Institute for Bautechnik, Berlin. In addition there are international certificates and conformities with the relevant standards and regulations. There are also the following certificates:

- TÜV approved performance.
- Certificate of the Institute for Acoustics and Building Physics (IAB), Oberursel, for noise transmission regulations in buildings (DIN 4109).
- TÜV approved leakage rate of backdraught shutter.
- External inspection of production by TÜV Bayern-Sachsen.
- Fire protection tests of back draught shutter and casing with fire protection, carried out by the Institute for Material Testing of the Institute for Baustoffe, Mas-sivbau and Brandschutz (IBMB), Braunschweig, swiss fire protection code Z 5491.

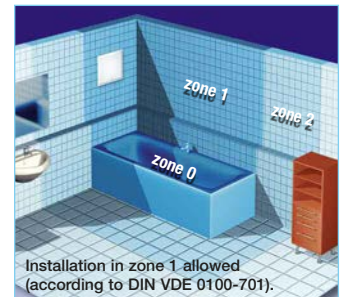

■ **Various operations.**



ELS units are available in approx. 100 variants and 3 airflows for ventilation of kitchen, bathroom and toilet in the apartment sector. User-friendly controls with overrun timer and interval timer function, automatic motion sensor or humidity controlled operation (in standard and demand-based ventilation) for barrierfree automatic operations are optional units.

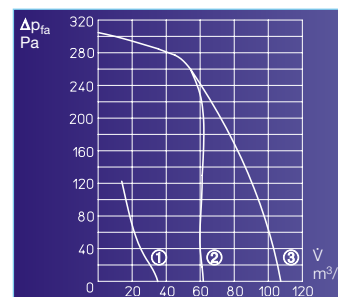

- ① Standard ventilation stage $\dot{V} = 35 \text{ m}^3/\text{h}$
- ② Demand-based ventilation stage $\dot{V} = 60 \text{ m}^3/\text{h}$ or standard ventilation stage for ELS-V 100/..
- ③ Demand-based ventilation stage for ELS-V 100/..

60 m³/h airflow volume at 260 Pa. This pressure capacity puts Helios ELS at the forefront of high-performance fans.

This permits the smallest pipe cross sections for the main riser, reduces investment costs and increases the usable living space.

Note
Further information about ELS types for barrier-free automatic operation

- with humidity control
- or PIR detector

see page 53

- **The Energy Saving Ordinance (EnEV 2016) demands the implementation of the low-energy house standard. The altered construction method and the resulting tight building shell place particular significance on the ventilation heat.**

According to the previous design, the ventilation technology is responsible for just 25% of the total energy consumption for heating. Given the sealed thermal building shell, these days this proportion is at least 50% in a modern residential building. Building planning in accordance with EnEV 2016 requires a comparison of a planned residential building with a reference building. A demand-based exhaust air system is standard for a reference residential building in accordance with EnEV 2016. Controlled apartment ventilation using a demand-based exhaust air system has reduced the minimum air exchange for window ventilation from 0,7 h⁻¹ or 0.6 h⁻¹ (with / without leak test) to 0.4 h⁻¹.

The use of Helios VF-AL systems technology can drop the creditable air exchange to as low as 0.35 h⁻¹. This reduction of the minimum air exchange generally lowers primary energy consumption by around 10%. Therefore the requirements for satisfying the KfW requirements (KfW efficient buildings) are significantly easier to fulfill.

- **Helios VF-AL systems technology with moisture-based ventilation control is an optimal solution for the current standard, including in when it comes to pricing.**

It is coordinated over the entire apartment and works according to the principle of vacuum air ventilation.

Exhaust air is taken from the rooms with contaminated air (bathroom, WC, kitchen). Fresh outside air flows through pressure-controlled incoming outside air elements into living rooms and bedrooms

- **Energy-efficiency and demand-optimised control functions are integrated in ELS appliances.**

Sophisticated technology enables demand-based and efficient ventilation according to the property-specific and room-specific tasks.

- **Barrier-free automatic operation** controlled by built-in presence sensors or moisture-controlled function. See adjacent and the right-hand side.

- **What is optimal and when?**

- **Demand-based ventilation with overrun**

Typical use: Ventilation of indoor bathrooms and WCs (overrun prescribed by DIN 18017) with normal frequency of use, e.g. in residential areas.

Applicable devices: Types ELS-VN, ELS-VNC or standard devices with separate overrun switches.

Control: Manual, possibly parallel with light.

- **Demand-based ventilation without overrun**

Typical use: Ventilation of kitchens and rooms with windows. High frequency of use in apartment buildings, hotels, retirement homes and many more.

Applicable devices: All standard ELS-V types

Control: Manual, via conventional installation switches or automatically using a timer.

- **Demand-based ventilation with overrun, presence-controlled or moisture-controlled**

Typical use: For barrier-free automatic operation in bathrooms, toilets and kitchens, as well as rooms with windows.

- **The system components**

- **ELS-VF**

Moisture-controlled exhaust air fan in the bathroom with intelligent moisture progression control to remove excessively high humidity in the air.

The type of increase in moisture is permanently checked by a microprocessor. The ventilation is demand-based and combined with a flow-controlled ELS in the toilet or kitchen.

- **Incoming outside air elements**

Incoming outside air elements for the reliable and efficient supply of incoming air. Types ALEF or ZL are built into window frames or walls.

Exhaust air systems without suitable incoming outside air elements are not suitable for function and do not comply with the state of the art.



- **Applicable devices:**

ELS types ELS-VF and ELS-VP

- **Function / control:**

Automatic, presence-controlled or moisture-controlled ventilation not activated by a switch. See the right hand side for a detailed description.

- **Interval ventilation**

Use: Ventilation of bathrooms and WCs (including interior bathrooms and WCs) with periodical low usage frequency, e.g. in hotel rooms, holiday apartments, student residences.

The adjustable interval and operating times ensure periodic and efficient room ventilation when the rooms are empty. Musty rooms and moisture damage are prevented.

Applicable devices: ELS VNC or standard types in combination with accessory ZNI.

Function: Automatic operation according to defined settings if room is not used. When manually operated (possibly switched in parallel to the light), overrun takes place according to the selected settings.

- **Time-controlled ventilation**

Use: Ventilation of toilets, showers, bathrooms, including rooms in office and administrative buildings, retirement homes, hospitals, etc.

Control: Interval-based or depending on use, i.e. at certain times of day.

- **Standard and demand-based ventilation:**

Ventilation of showers, bathrooms, WCs with high air contamination (e.g. in restaurants, offices).

The continuous, low-noise standard ventilation operation to combat smells and excess moisture. When the room is in use, the system manually switches to high-performance (demand-based level). This is automatically possible during certain times of day using a timer

Applicable devices: All types with 2 or 3 power settings.

Switching: Required for manual DSEL 2 or DSEL 3 operation. We recommend appropriate components for automatic operation.

■ **The top solution for barrier-free automatic operation: Integrated PIR sensor**

Optimal fan control in toilets and sanitary facilities with industrial and private use for example, in hostels, hotels, offices, etc.

- Helios offers the ideal solution: ELS-VP is fitted with a PIR as standard; the fan starts automatically when a person enters the room. The electrical connection is direct to the power supply without need for a switch.

- ELS-VP with motion sensor ventilates automatically as required when entering the room.

- An integrated PIR sensor registers the presence of people and switches on the unit. The unit operates for 15 minutes. If a movement in the room is detected within that time, the operation time is extended respectively.

- When leaving the room, there is a run-on time of 15 minutes.

- Ideally the fan should be fitted so the movement in the room is always detected, so position is important and the PIR sensor should not be hindered by obstructions.

Typical use: Barrier-free, automatic ventilation without using a switch.

Control: PIR controlled.

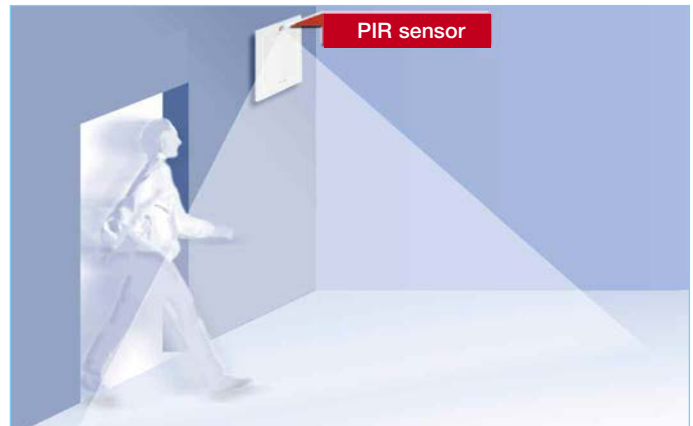
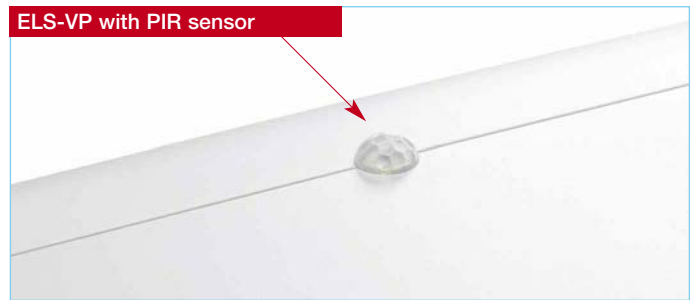

■ **ELS-VF automatic moisture progression system is far superior to conventional humidity switches and prevents the build-up of damp on the walls, ceiling and equipment. It guarantees a healthy climate without mould and bad smells with minimal energy consumption.**

■ **Advanced electronics**

ELS-VFs are equipped with fully-automatic, moisture-dependent controls. The microprocessor-controlled electronics detect two forms of moisture increase:

- Given a normal increase in moisture over time (e.g. washing, drying, temperature drops), the fan switches on when the defined setpoint is reached and runs until the moisture in the room air has dropped by approximately 10%, but at least for the duration of the defined overrun.
- In the case of a rapid increase in moisture (e.g. due to showering, bathing), the ventilator turns on before the defined limit value is reached to get rid of the excess moisture in the room as effectively and quickly as possible. This prevents mirrors or walls from suffering from moisture and damp damage and the comfortable range in the room (40-70%

relative humidity) is quickly re-stored. As soon as the relative humidity has fallen by 10%, but not before the end of the pre-set overrun time, the fan turns off.

- In the case of extended, excessive moisture increases (e.g. storms in summer, damp washing in the room) if air circulation is insufficient as the intake air openings are too small or closed, the fan turns off automatically after two hours of continuous operation. In these cases, the control has identified that further ventilation will not lower the humidity. Depending on the further moisture progression, the fan will start automatically within the next 2 to 6 hours to once again reduce humidity by around 10%. This control behaviour is repeated until humidity has fallen to the desired level.

The moisture progression system automatically adjusts itself to achieve optimal humidity reduction while expending the minimum amount of energy.

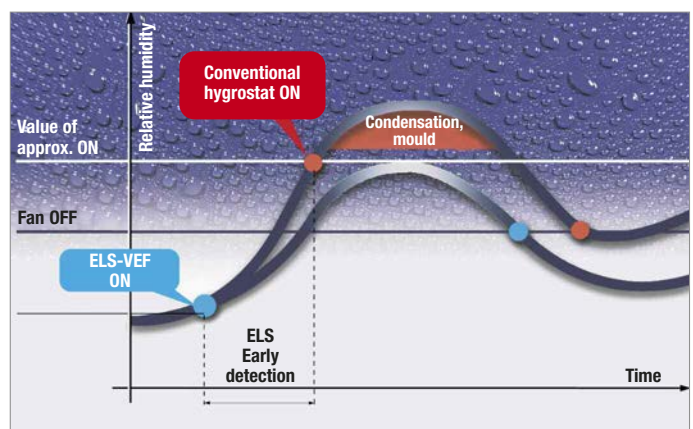

- **Typical use:** For ventilation of humidity polluted rooms (e.g. bathroom, kitchen).
- **Control:** Barrier-free automatic operation, on the humidity levels.
- Supply air is necessary so that humid air can be extracted by the fan.

- The flush mounted casings ELS-GU and -GUBA are totally adaptable in terms of installation position and range of use.
- The standard flush mounted casing ELS-GU and -GUBA, the flush mounted casing with fire protection shutter, is the ideal solution for many different applications.
- Whether for one and two room ventilation or for toilet seat adaptation via flushing pipe. The flush mounted installation is suitable for wall, shaft, plasterboard or ceiling.
- The discharge spigot can be positioned alternatively to the back or on top, also the casing, can be turned by 90° to the left or to the right. Simple and without tools.
- One casing type for every installation form and every ventilation demand. This is not only practical at the building site but also makes stock keeping extremely economical.

See accompanying examples:

- ① One room ventilation
Extraction via facia
- ② Two room ventilation or toilet seat adaptation via flushing pipe
Discharge to the top
- ③ Two room ventilation or toilet seat adaptation via flushing pipe
Discharge to the back

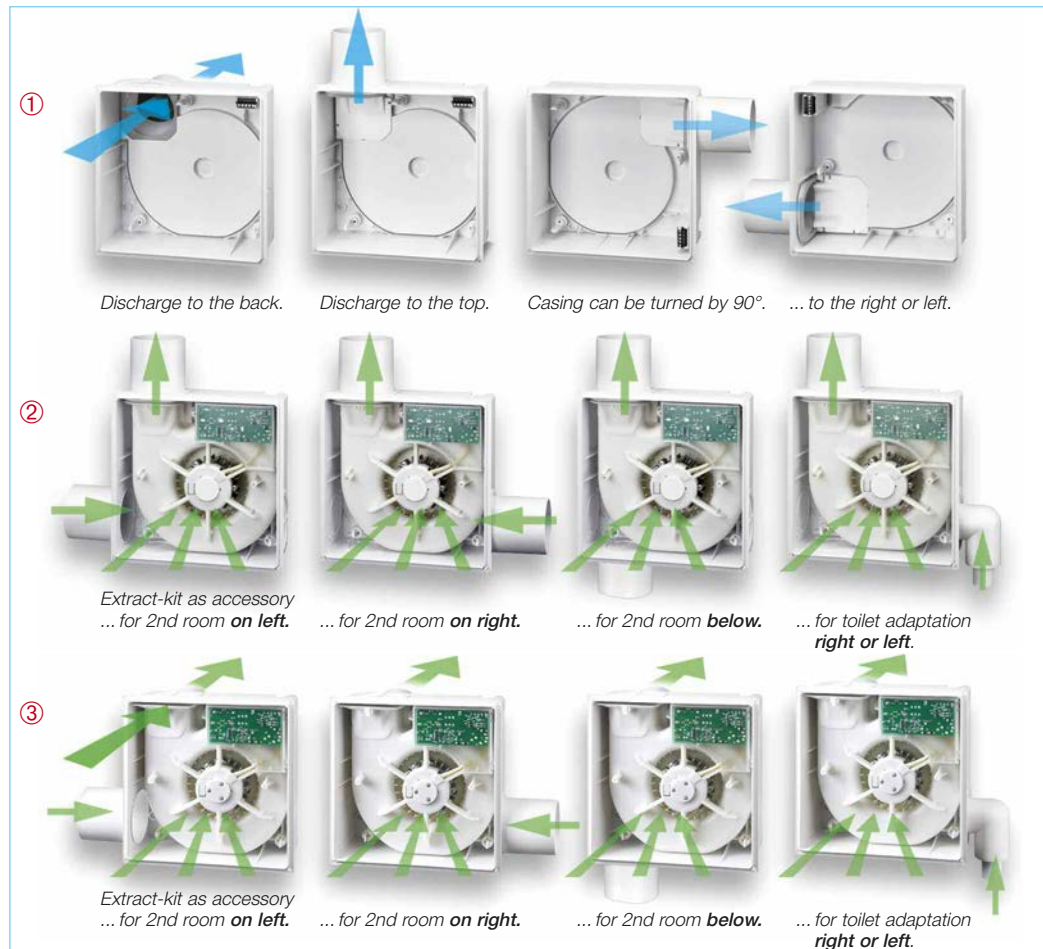

- During the construction of the mono tube ventilation system from Helios professionals were at work. This can be seen above all in many clever assembly details.

■ Trouble-free quick installation

- The universal mounting bracket ELS-MHU brings the necessary flexibility with installation in shafts and false ceilings.
- All flush mounted casings can be easily positioned vertically, in height or perpendicular in a few minutes. ELS-MHU is suitable for the installation of flush mounted casings with and without fire protection encasement.
- On the rear of the casing types ELS-GU and -GUBA embedded turn lock slots for hexagon or square head screws take up the mounting holder which is vertically adjustable as well as in height and depth. Alternatively there are two predetermined breaking points for direct screw connection with elements by customer.
- For plasterboard system integration, the ELS-MB forms the ideal combination with system elements.

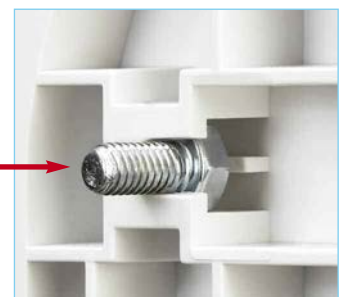
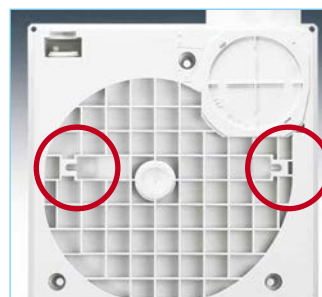
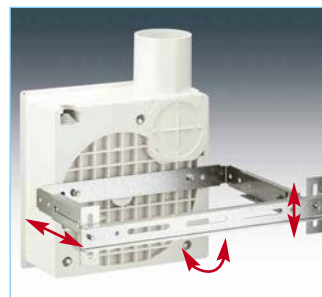

■ Plasterboard adapter ELS-VA

- Simplifies the installation of casing -GU, -GUBA in covered shafts and plasterboards. Make penetration. Mark the square opening with press pins at casing and cut it out. Connect flexible duct with discharge spigot. Make electrical connection. Insert casing with plasterboard adapter room-sided and screw in place. Everything fits in a few minutes!



■ Information about fire protection in buildings

Planning and execution of ventilation systems has to comply with national fire protection requirements. Usually buildings with more than two storeys are subject to such requirements.

In order to prevent fires from spreading to other fire zones, the following solutions can be used for the installation of mono tube ventilation systems depending on structural circumstances:

Flush mounted installation in fire resistant shaft (F90) or L90-ventilation duct.

Applicable casings: Every ELS-GUB casing with fire protection encasement and back draught shutter K90-18017. Steel flexpipe connection for second room connection only.

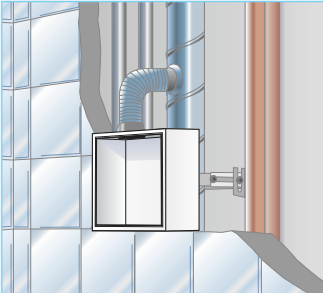
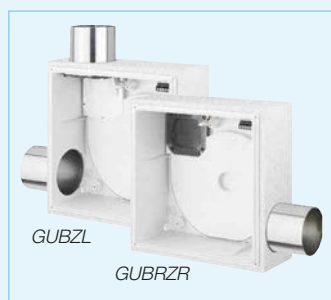
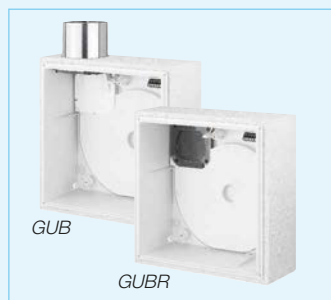
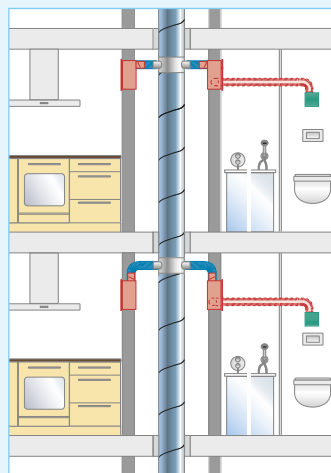
Flush- or surface mounted installation outside of fire resistant shafts (F90) or L90 ventilation ducts

Applicable casings: -GUBA (flush) or -GAPB (surface) with fire protection encasement and back draught shutter K90-18017. Steel flexpipe connection to the main riser.

□ GUBA
The casing ELS-GUBA can be installed in any position (vertical, horizontal) or turned by 90° to the left or right by changing discharge spigot position. Also a discharge to the rear, second room connection or toilet seat adaptation is possible by means of accessories kit.

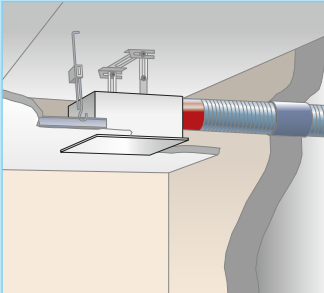
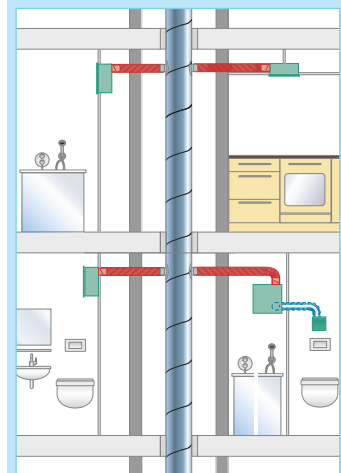
Surface mounted installation on walls of fire resistant shafts (F90) or L90 ventilation ducts.

Applicable casings: ELS-GAPB casing with fire protection encasement and back draught shutter K90-18017.

□ GAPB
The casing ELS-GAPB can be mounted by turning the discharge spigot around 360°, so that the air discharge can be positioned on top left or right and below left or right.

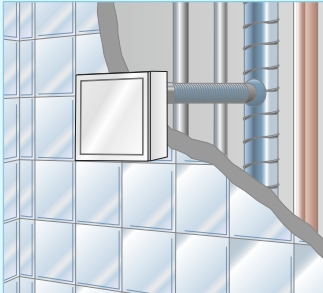
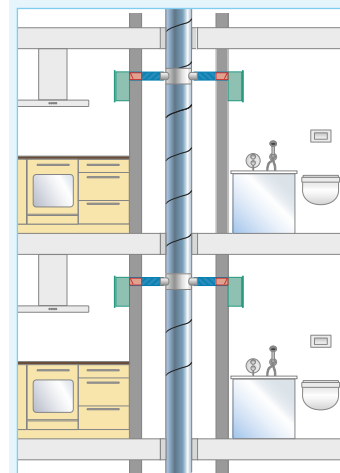
Fire protection solution with fire damper ELS-D



Applicable casings: Universal casing without fire protection ELS-GU for flush mounted or ELS-GAP for surface mounted installation.

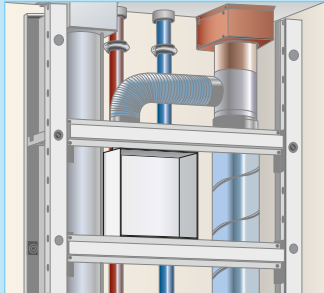
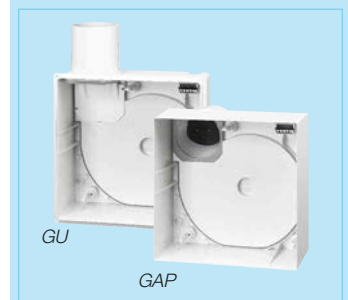
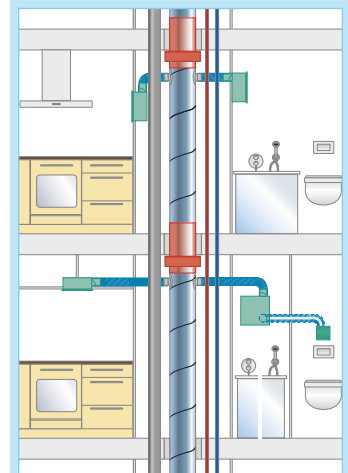

□ Flush mounted casing ELS-GU
ELS-GU can be used like type -GUBA and shown in detail on the page 54 in universal variety.

□ Surface mounted installation ELS-GAP
Installation and positioning like ELS-GAPB, see left.

■ ELS casings without fire protection, for flush and surface mounted installation

with / without fire protection	Casing	Type / Specification	Application	Accessory ¹⁾	Discharge lateral, to the top, left or right	Discharge to the back using accessory ¹⁾	One room ventilation	Two room ventilation using accessory ¹⁾
 For buildings with up to 2 floors without fire protection.		Flush mounted casing without fire protection , with airtight backdraught shutter. Spigot lateral, to the top (as supplied), rotatable to the left or right. Changeable by means of an accessory set ELS-ARS for discharge to the back in any position. Quick plug connector for electrical connection which is removable. Made from polymer (white), fire class B 2. Reinsertable cover plate. Spigot diameter 80 mm. Generally approved by the DIBt with approval no. Z-51.1-193.	For ventilation of kitchen*, bathroom or toilet, by means of accessory set also for two room ventilation of bathroom and toilet*. Flush mounted installation in wall, ceiling or shafts. Connection of up to 3 casings per floor is possible. For connection to main duct up to 2 floors without fire protection requirement. With fire protection by the use of fire damper in main duct for more than 20 floors is possible.	•	•	•	•	
		Surface mounted casing without fire protection , with airtight backdraught shutter installed in the discharge spigot, for any mounting position and rotatable by 90°. With quick plug connector for electrical connection. With quick plug connector for electrical connection 2. Discharge spigot diameter 80 mm. Generally approved by the DIBt with approval no. Z-51.1-193.	For ventilation of kitchen*, bathroom or toilet. Surface mounted installation in wall or ceiling. Connection of up to 3 casings per floor possible. For connection to main duct up to 2 floors without fire protection requirement. With fire protection by the use of fire damper in main duct for more than 20 floors is possible.	—	•	•	—	











■ ELS casings with fire protection shutter, for flush and surface mounted installation

Fire protection	Casings	Type / Specification	Application	Accessory ¹⁾	Discharge lateral, to the top, left or right	Discharge to the back using accessory ¹⁾	One room ventilation	Two room ventilation using accessory ¹⁾
 for positioning outside of F90 ventilation shaft		Flush mounted polymer casing with fire protection shutter K 90, metal discharge spigot with automatic backdraught shutter and shut-off with release of fusible link . Discharge spigot lateral to the top (as supplied), rotatable to the left or right. Changeable by means of an accessory set for discharge to the back in any position. Reinsertable cover plate. Spigot diameter 80 mm. Generally approved by the DIBt with approval no. Z-51.1-193.	For ventilation of kitchens*, bathroom or toilet. By means of accessory set ELS-ZS also for two room ventilation of bathroom and toilet*. Flush mounted installation in ceiling or wall, as well as outside of K 90-shafts suitably fire rated. Connection of up to 3 casings per floor on more than 20 floors possible.	•	•	•	•	
		Surface mounted casing with fire protection shutter K 90, metal discharge spigot with automatic backdraught shutter and shutoff with release of fusible link . For any mounting position and rotatable by 90°. With quick plug connector for electrical connection. Made from polymer (white), fire class B 2. Discharge spigot diameter 80 mm. Generally approved by the DIBt with approval no. Z-51.1-193.	For ventilation of kitchens*, bathroom or toilet. Surface mounted wall or ceiling installation. Connection of up to 3 casings per floor on more than 20 floors possible.	—	•	•	—	



* For kitchens and two room ventilation of bathroom and toilet use of fan unit with 100 m³/h recommended.



²⁾ Consisting of second room plenum box and spigot for second room connection, see page 60.

¹⁾ Details and specifications to ELS-accessories see page 60.

■ ELS flush mounted casings with fire protection encasement, for one room ventilation				Discharge lateral, to the top, left or right	Discharge to the back	One room ventilation	Extraction unit for 2 rooms (Accessories ¹⁾)		
Fire protection	Casings	Type / Specification	Application						
 <p>Casing installation in F90 ventilation shaft</p>		<p>Flush mounted casing with fire protection encasement K 90, Metal discharge spigot with automatic backdraught shutter and shut-off with release of fusible link. Discharge spigot lateral to the top (as delivered), turnable to the left or right. Quick plug connector for electrical connection removable. Reinsertable cover for protection when plastering. Spigot diameter 80 mm. Generally app. by the DIBt with approval no. Z-51.1-193.</p> <p>Type ELS-GUB Ref. no. 8112</p>	<p>For ventilation of kitchen*, bathroom or toilet. wall, ceiling or F90 qualified shafts suitably fire rated. Connection of up to 3 casings per floor on more than 20 floors possible.</p> 	•	—	•	—		
		<p>As ELS-GUB, however discharge spigot to the back, rotatable by 90° in any position. For the shortest connection to the main line. Generally approved by the DIBt with approval no. Z-51.1-193.</p> <p>Type ELS-GUBR Ref. no. 8113</p>	<p>As Type ELS-GUB.</p>	—	•	•	—		
■ ELS flush mounted casings with fire protection encasement, for two room ventilation				 <p>Casing installation in F90 ventilation shaft</p>		<p>Two room ventilation of bathroom and toilet*. Installation in wall, ceiling and F90 shafts suitably fire rated. Connection of up to 3 casings per floor on more than 20 floors possible.</p>	<p>ELS-ZS Ref. no. 8186</p>		
	<p>Flush mounted casing with fire protection encasement K 90 and spigot for second room on the left. Metal discharge spigot with automatic backdraught shutter and shut-off with release of fusible link. Discharge spigot for main room above (as delivered), laterally rotatable to the left or right. Quick plug connector for electrical connection removable. Reinsertable cover plate. Spigot diameter 80 mm. Generally approved by the DIBt with approval no. Z-51.1-193.</p> <p>Type ELS-GUBZL Ref. no. 8115</p>	<p>As Type ELS-GUBZL.</p>	•					—	—
	<p>As ELS-GUBZL, however spigot for second room on the right. Generally approved by the DIBt with approval no. Z-51.1-193.</p> <p>Type ELS-GUBZR Ref. no. 8117</p>	<p>As Type ELS-GUBZL.</p>	•					—	—
	<p>As ELS-GUBZL, however discharge spigot to the back and rotatable by 90° into any position. Generally approved by the DIBt with approval no. Z-51.1-193.</p> <p>Type ELS-GUBRZL Ref. no. 8116</p>	<p>As Type ELS-GUBZL.</p>	—					•	—
	<p>As ELS-GUBZR, however discharge spigot to the back and rotatable by 90° into any position.</p> <p>Type ELS-GUBRZR Ref. no. 8118</p>	<p>As Type ELS-GUBZL.</p>	—	•	—				

* For kitchens and two room ventilation of bathroom and toilet use of fan unit with 100 m³/h recommended. ¹⁾ Details and specifications to ELS-accessories see page 60. The check valve for fire protection casings fulfills the requirements of a cold smoke shutter.

60 m ³ /h		60 m ³ /h air flow volume For bathrooms or toilets		Accessories			
Type	Description	Application	DSEL 2 No. 1306 Speed and operating switch	ZT No. 1277 Time-variable overrun timer	ZNE No. 0342 ZNI No. 0343 Overrun timer	ZV No. 1279 Electronic overrun timer	
ELS-V 60 Ref. no. 8131 	Fan unit with 60 m³/h air flow volume . Delivered complete with flat facia (alpine white) and ultraSilence® technology. With permanent filter and filter control as standard. Integrated quick plug connector for electrical connection. Insulation class II, protection to IP 55, for installation in zone 1 of bathrooms. Maintenance free, energy saving ball bearing motor 230 V~, 50 Hz, 18 W. Sound power 39 dB(A) ¹⁾ , sound pressure 35 dB(A) ^{* 1)} . General technical approval no. Z-51.1-193.	For ventilation of shower, bathroom or toilet. Control manually via the light switch. The overrun which is necessary in windowless rooms is to be provided by means of an overrun timer (accessories).	—	•	•	•	
ELS-VN 60 Ref. no. 8137	As ELS-V 60, but with integrated overrun timer , run on time approx. 6, 15, 21 min. (adjustable), delayed start approx. 45 sec. (non-adjustable).	For ventilation of rooms as previously mentioned. With overrun function for windowless rooms. Control via the light switch.	—	—	—	—	
ELS-VNC 60 Ref. no. 8143	As ELS-V 60, but with adjustable overrun timer and interval operation . Delayed start 0 or 45 sec., run on time 6, 10, 15 or 21 min. and interval time 4, 8, 12 or 24 hours adjustable.	Automatic, periodical ventilation of rooms with low user frequency (hotel, holiday homes). Individually adjustable run over times increase the comfort in the private area.	—	—	—	—	
ELS-VP 60 Ref. no. 8149	As ELS-V 60, but with integrated motion sensor for automatic ventilation when entering the room. Run on time approx. 15 min. Electrical connection is direct to the power supply without need for a switch.	Automatic, PIR controlled ventilation without the need of a switch. Automatically switches on with room occupancy. See page 53 for details.	—	—	—	—	
ELS-VF 60 Ref. no. 8161	As ELS-V 60, but with electronic humidity sensor . Automatic ventilation when set humidity set point is reached, switches off automatically after humidity reduction of approx. 10%. In case of manual operation, delayed start 0 or 45 sec., run on time 6, 10, 15 or 21 min. adjustable.	Ideally for the prevention of damage to the building due to humidity and mould in small, high humidity rooms. Automatically switches on with raised humidity. See page 53 for details.	—	—	—	—	
60/35 m ³ /h		2 speeds 60/35 m ³ /h For bathrooms or toilets					
ELS-V 60/35 Ref. no. 8133 	Fan unit with 2 speeds (60/35 m³/h) for standard and demand-based ventilation . Delivered complete with flat facia (alpine white) and ultraSilence® technology. With permanent filter and dirty filter indicator as standard. Integrated quick plug connector for electrical connection. 230 V~, 50 Hz, 18/9 W. Sound power 39/30 dB(A) ¹⁾ , sound pressure 35/26 dB(A) ^{* 1)} . Otherwise as ELS-V 60.	For ventilation of small rooms (shower, bathroom, toilet) with high polluted air. The low speed can be connected for continuous trickle operation. The high speed is then controlled manually via the light switch. Manual control of both speed steps with switch DSEL 2 possible. Run on time by using available accessory.	•	•	—	•	
ELS-VN 60/35 Ref. no. 8139	As ELS-V 60/35, but with integrated overrun timer , run on time approx. 6, 15, 21 min. (adjustable), delayed start approx. 45 sec. (non-adjustable).	As ELS-V 60/35. The built-in overrun timer causes extended operation on high performance level after manual switching off.	•	—	—	—	
ELS-VF 60/35 Ref. no. 8163	As ELS-V 60/35, but with electronic humidity sensor . Standard ventilation at continuous operation. Automatic ventilation when set humidity set point is reached, switches off automatically after humidity reduction of approx. 10%. In case of manual operation, delayed start 0 or 45 sec., run on time 6, 10, 15 or 21 min. adjustable.	Ideal for preventing humidity damage. See page 53 for details. The small step can be used for continuous operation. Large step is automatically activated depending on humidity. Manual control of both steps possible with DSEL 2 switch.	•	—	—	—	

100 m ³ /h		100 m ³ /h air flow volume For bathrooms <u>and</u> toilets or kitchens		Accessories			
Type	Description	Application	DSEL 2 No. 1306 Speed and operating switch	ZT No. 1277 Time-variable overrun timer	ZNE No. 0342 ZNI No. 0343 overrun timer	ZV No. 1279 Electronic overrun timer	
ELS-V 100 Ref. no. 8132 	Fan unit with 100 m³/h air flow volume . Delivered complete with flat facia (alpine white) and ultraSilence® technology. With permanent filter and filter control as standard. Integrated quick plug connector for electrical connection. Insulation class II, protection to IP 55, for installation in zone 1 of bathrooms. Maintenance free, energy saving ball bearing motor 230 V~, 50 Hz, 29 W. Sound power 51 dB(A) ¹⁾ , sound pressure 47 dB(A) ^{*1)} . General technical approval no, Z-51.1-193.	Simultaneous ventilation of bathroom and toilet (flush mounted). Ventilation of domestic kitchens. Overrun function possible with accessories.	—	•	•	•	
ELS-VN 100 Ref. no. 8138	As ELS-V 100, but with integrated overrun timer , run on time approx. 6, 15, 21 min. (adjustable), delayed start approx. 45 sec. (non-adjustable).	Simultaneous ventilation of bathroom and toilet (overrun required by DIN). Ventilation of domestic kitchens.	—	—	—	—	
ELS-VNC 100 Ref. no. 8144	As ELS-V 100, but with adjustable overrun timer and interval operation . Delayed start 0 or 45 sec., run on time 6, 10, 15 or 21 min. and interval time 4, 8, 12 or 24 hours adjustable.	Automatic, periodic ventilation of rooms (also covers two-room ventilation) with irregular use, such as e.g. in hotels, holiday homes. Comfort solution in private sector.	—	—	—	—	
ELS-VP 100 Ref. no. 8150	As ELS-V 100, but with integrated motion sensor for automatic ventilation when entering the room. Run on time approx. 15 min. Electrical connection is direct to the power supply without need for a switch.	Automatic, presence-controlled ventilation without switch operation. Barrier-free with automatic function. See page 53 for details.	—	—	—	—	
100/60/35 m ³ /h		2, 3 speeds 100/60 m ³ /h, 100/60/35 m ³ /h For bathrooms <u>and</u> toilets or kitchens					
ELS-VN 100/60 No. 8141 	Fan unit with 2 speeds (100/60 m³/h) for standard and demand-based ventilation and integrated overrun timer . Run on time approx. 6, 15, 21 min. (adjustable), Delayed start approx. 45 sec. (non-adjustable). Delivered complete with flat facia (alpine white) and ultraSilence® technology. With permanent filter and dirty filter indicator as standard. 230 V~, 50 Hz, 29/18 W. Sound power 51/39 dB(A) ¹⁾ , sound pressure 47/35 dB(A) ^{*1)} . Otherwise as ELS-V 100.	Simultaneous ventilation of bathroom and toilet (flush mounted). Ventilation of domestic kitchens. With near-silent standard ventilation stage. The small performance step can be used for continuous operation. The demand-based ventilation is activated manually by light switch. Manual control of both steps with DSEL 2 switch (accessories).	•	—	—	—	
ELS-V 100/60/35 No. 8136	As ELS-V 100, but with 3 speeds (100/60/35 m³/h) for demand-based and standard ventilation . 230 V~, 50 Hz, 29/18/9 W. Sound power 51/39/30 dB(A) ¹⁾ , sound pressure 47/35/26 dB(A) ^{*1)} .	Medium or small performance step can be used for continuous operation and switched with DSEL 2. Manual 3-step control with DSEL 3.	• or DSEL 3 Ref. no. 1611	•	—	•	
ELS-VF 100/60/35 No. 8166	Fan unit with 3 speeds (100/60/35 m³/h) for demand-based and standard ventilation and with electronic humidity sensor . 230 V~, 50 Hz, 29/18/9 W. Sound power 51/39/30 dB(A) ¹⁾ , sound pressure 47/35/26 dB(A) ^{*1)} . Otherwise as ELS-VF 60/35.	Ideal for preventing humidity damage. See page 53 for details. The small or medium step can be switched with DSEL 2 for continuous operation. Large step is automatically activated depending on humidity. Manual 3-step control with DSEL 3.	• or DSEL 3 Ref. no. 1611	—	—	—	

* at A_L = 10 m² equivalent absorption surface in combination with casing type ELS-GU, side discharge. Information according to DIN 18017-3:2009-09, section 7.2.4. footnote 5.

¹⁾ Noise data for surface installation see table on page 64.

Adaption kit for rear discharge

Type ELS-ARS Ref. no. 8185

For discharge to the rear with all flush mounted casings ELS-GU and -GUBA without fire protection encasement. Simply fit the ARS diverter on the discharge side of the fan unit to ensure a proper air guide.



Toilet extraction kit

Type ELS-WCS Ref. no. 8191

WC-Kit for connection of toilet seat extraction system in combination with room ventilation; for casing types ELS-GU, -GUBA. The connection between casing and flushing tank tube is carried out with customary plastic tubes. Scope of delivery: Cap, bend 90°, two-step spigot Ø 40 and 30 mm.

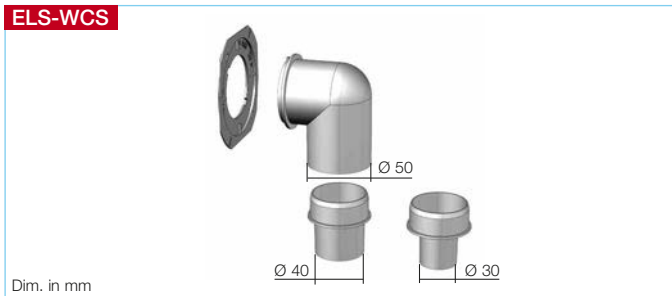

Second room kit

Type ELS-ZS Ref. no. 8186

Inlet air plenum box for flush mounted installation for connection with all casings for second room connection ELS-GU. Design awarded facia in white, with covered front and air inlet on all sides. Integrated, easy accessible air filter. Including second room spigot for casing ELS-GU and -GUBA.



ELS-ZAS

Second room spigot

Type ELS-ZAS Ref. no. 8184

Insert spigot for casing types ELS-GU and -GUBA. For connection of second room ventilation on site. nom. diameter 75/80 mm.



Plasterboard adapter

Type ELS-VA Ref. no. 8189

Makes room-sided casing insertion and installation for flush mounted ELS casings in covered shafts and plasterboards possible. The adapter is bolted with the casing and its frame is fastened with screws to the plasterboard.

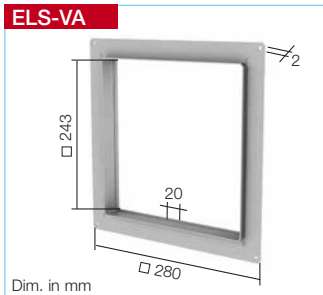

Universal mounting bracket

Type ELS-MHU Ref. no. 8187

Principally for flush mounted casing installation in shafts, especially with casings with fire protection encasement. For fixing on ceilings or walls. Adjustable vertically, in height and perpendicular. Suitable for all flush mounted casings.

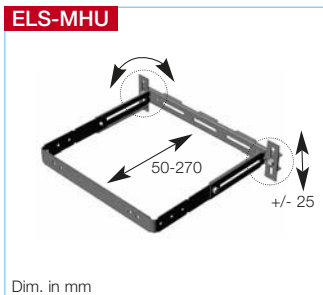

ELS-MB

Mounting holder

Type ELS-MB Ref. no. 8188

For integration of flush mounted casings in plasterboard systems in connection with system elements of plasterboard supplier. The mounting holder is simply fixed with hexagon or square head screws to the embedded turn lock slots on the back side of the ELS casing.

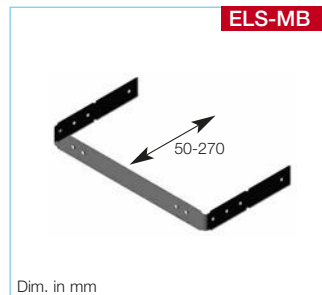

Spacer frame

Type ELS-AGR Ref. no. 8193

Covers up to 15 mm of flush-mounted casing, which was not installed level with the plaster or tiles.

The spacer frame is simply fixed between the wall/ceiling and ELS inner facia.

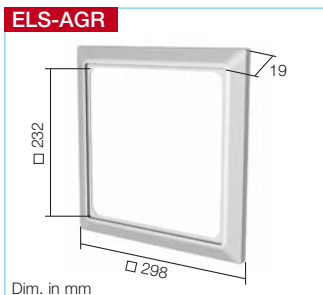

ELS-PB

Plasterboard cover

Type ELS-PB Ref. no. 8194

To cover gaps of unclean plastered, tiled or oversized casing openings, which are not completely covered by the ELS facia.

The plasterboard cover is simply fixed between wall/ceiling and ELS inner facia.

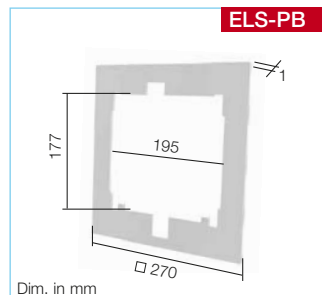

Fire protection

The transfer of fire and smoke to other floor levels must be prevented when buildings are higher than two storeys with certified fire protection elements, classification K 90-18017.

The following options and the options described in detail on page 55 can be used here according to structural circumstances.

- Casing ELS-GUB, with fire protection cladding
In fire-resistant shaft (F90) or L90 ventilation duct.
- Casing ELS-GUBA, -GAPB with fire protection shutter for casing positioning outside of fire resistant shaft (F90) or L90 ventilation duct. Connection to main duct with flexible steel duct.

- Fire damper ELS-D
For installation in ventilation main duct Approved for use in ventilation shafts and within mixed service shafts (even with flammable services), only needs to be covered with a 12.5 mm plaster-board. All ELS fans, connected with flexible aluminium ducting do not need any fire protection classifications.

ELS-D Z-41.3-368



Fire damper ELS-D

When using this barrier, all other component parts do not need any fire protection classification. The universal applicable casing types ELS-GU (flush) and GAP (surface) can be connected.

The low cost and assembly-friendly flexible aluminium ducting can be used for the connections. See page 522 for detailed information.

ND mm main duct	100	125	140	160	180	200
Type	ELS-D 100	125	140	160	180	200
Ref. no.	0270	0185	0186	0187	0188	0271

Intake air elements

– Installation in wall openings



Universally applicable supply air units and thermostatic supply valves for the demand-based intake air volume control. See intake air element product page for detailed description.

	ø 80		ø 100		ø 160	
Type	Ref. no.	Type	Ref. no.	Type	Ref. no.	
Supply air unit – Automatically temperature controlled incl. thermostatic supply valve, attenuator and external grille						
ZLA 80	0214	ZLA 100	0215	ZLA 160	0216	
Supply air element – Manually adjustable in four steps incl. valve plate with pull cord, attenuator and external grille						
		ZLE 100	0079			
Thermostatic supply valve – For installation in existing ventilation openings						
ZTV 80	0078	ZTV 100	0073	ZTV 160	0074	

– Installation in window frames



Intake air element with air flow controller and limiter. See intake air element product page for detailed description. Ideally suited for retrofitting and new construction.

V				
m³/h	Type	Ref. no.	Type	Ref. no.
Intake air element for installation in window frames – with air flow controller and limiter				
30	ALEF 30	2100	ALEFS 30	2102
45	ALEF 45	2101	ALEFS 45	2103
Intake air element for installation in window frames – humidity controlled, with air flow controller and limiter				
7/40	ALEF Hygro 6/45	2056	ALEFS Hygro 6/45	2057

Overflow



Door grilles

Discreet, screened door transfer grille made from impact resistant polymer, for door installation. See ventilation grille product page for detailed description.

Type LTGW Ref. no. 0246
Made from white polymer.

Type LTGB Ref. no. 0247
Made from brown polymer.

Spare filters



Spare air filter

Filter mats made from regenerable synthetic fibre, class G2.

Type ELF/ELS Ref. no. 8190
Permanent filter for fan units ELS-V, dishwasher-safe, contents = 2 pcs.

Type ELF-ZS Ref. no. 0557
For second room plenum box ELS-ZS, contents = 5 pcs.

Information	Page
Dimensions, detailed technical information as well as further sizes:	
Ventilation grilles	487 on
Intake air elements	512 on
Fire protection elements for use in multi-storey construction with more than 2 full storeys	516 on
Controllers and switches	525 on

The regulations in DIN 18017-3 have been integrated in the diagrams below for simple determination.

60 m³/h Bathrooms or toilets

1 unit per floor

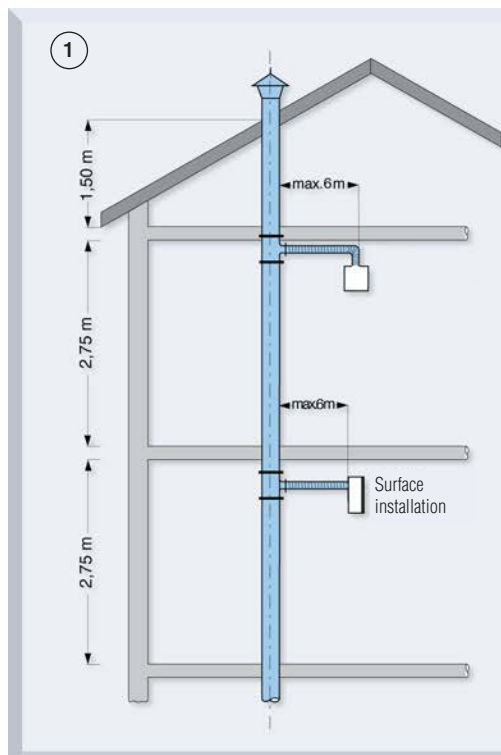

Installation of 1 unit per floor
with 60 m³/h planned air flow volume and
operation of all units at the same time.

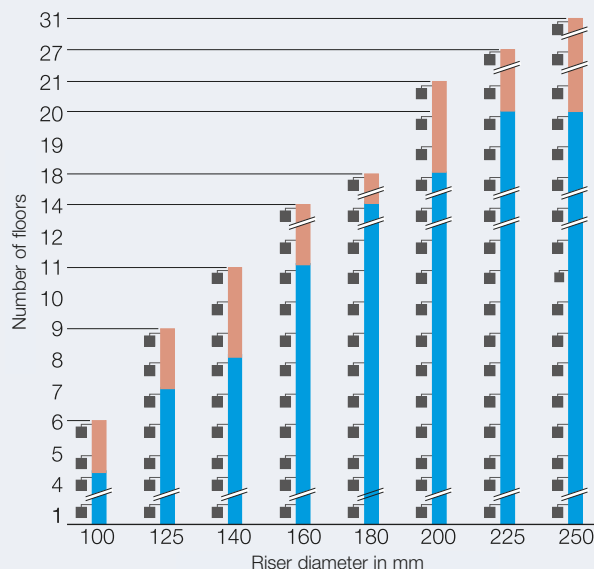

2 units per floor

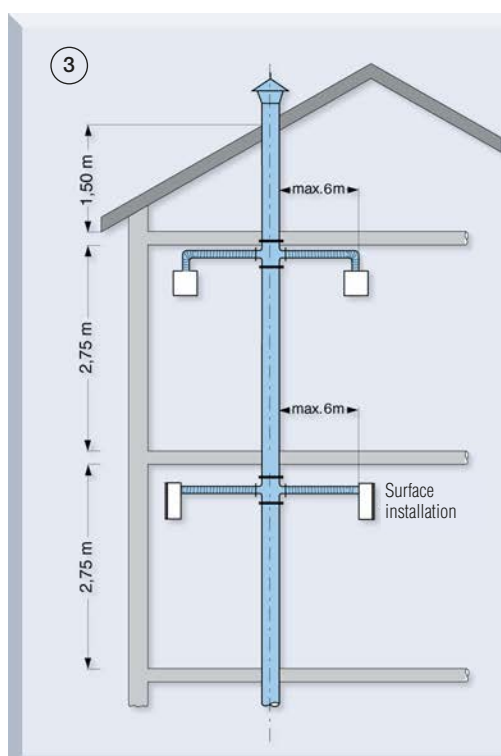

Installation of 2 units per floor
with 60 m³/h planned air flow volume and
operation of all units at the same time.

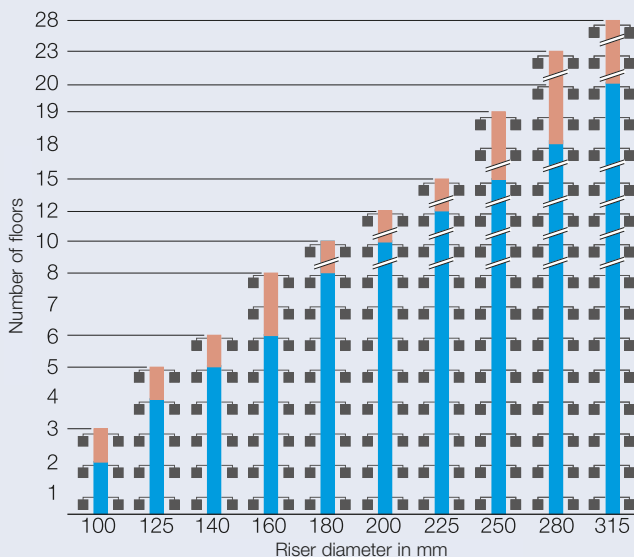

Assuming a room height of 2.75 m, a straight ducting without bends, a ducting length of max. 1.5 m from last unit to air extract above the roof as well as max. 60 Pa between ventilated room and exhaust opening, the required main riser diameter can be read from the diagram above.
They are valid for a planned air flow volume of 60 or 100 m³/h per unit and operation of all units at the same time.

Standard and individual plans can be created easily and quickly with the Helios ELS software. Graphic representation, dimensioning of the main duct with or without warpage become child's play. Cost allocation and materials list are automatically created and printed. Information on the planning and design can be found in DIN 18017-3 and the approval documents and test certificates. We will be happy to send approval documents and test certificates upon request. Approval no. Z-51.1-193.

System dimensioning for these floor heights is not recommended.
Preferred system dimensioning in blue area (comfort zone).

Without reliable supply air backflow through intake air inflow elements ALEF and ZL, the exhaust air systems are not functional and do not comply with engineering rules.

100 m³/h Kitchens and two room ventilation

1 unit per floor (possibly with two room connection)

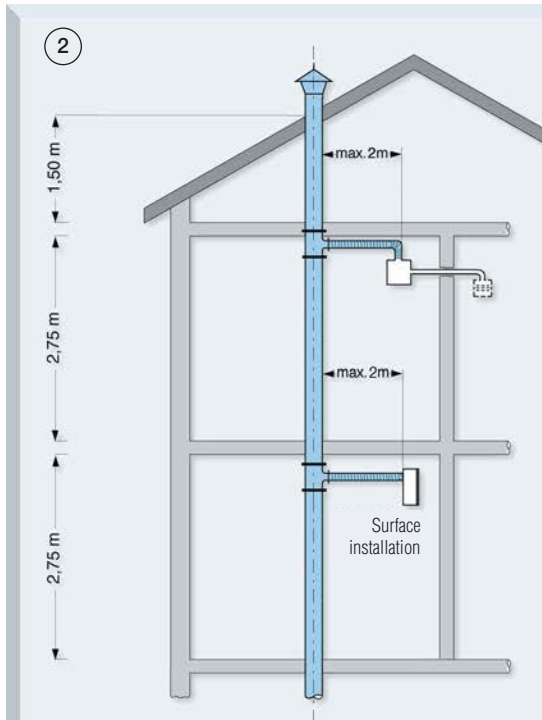

Installation of 1 unit per floor

with 100 m³/h planned air flow volume and operation of all units at the same time. (Volume e.g. kitchen = 100 m³/h. For two room ventilation with 1 unit = Bathroom 60 m³/h, toilet 40 m³/h).

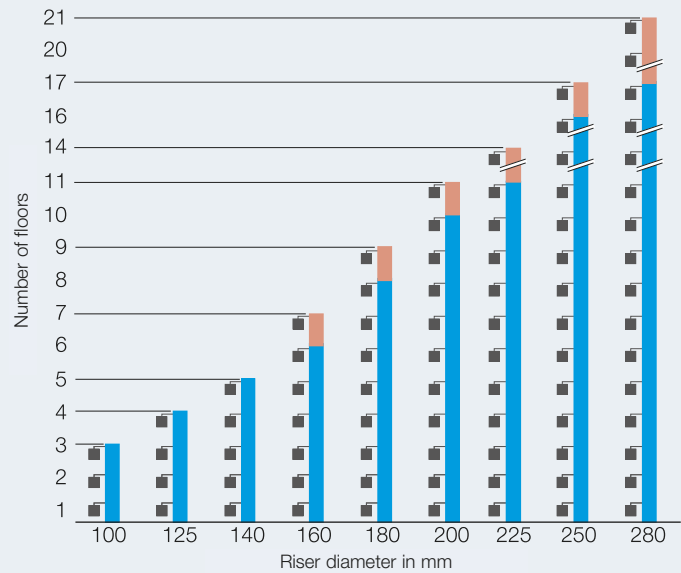

2 units per floor (possibly with two room connection)

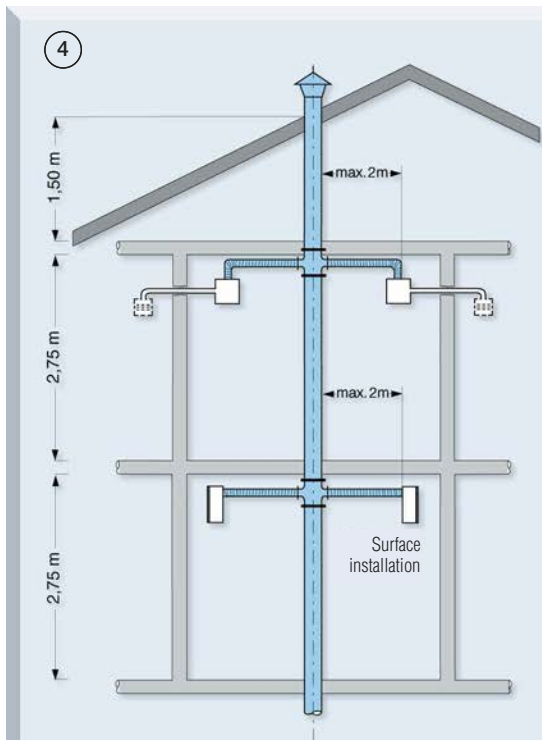

Installation of 2 units per floor

with 100 m³/h planned air flow volume and operation of all units at the same time. (Volume e.g. kitchen = 100 m³/h. For two room ventilation with 1 unit = Bathroom 60 m³/h, toilet 40 m³/h).

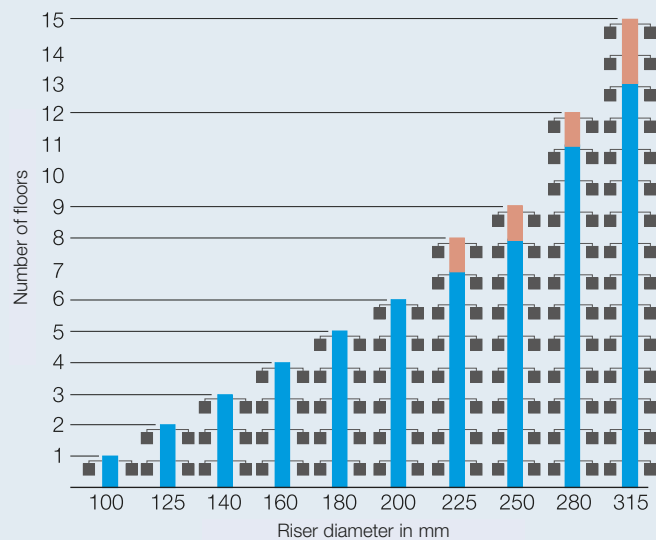

Example 1:

Type of room: Bathroom/Toilet

$\dot{V} = 60 \text{ m}^3/\text{h}$

Units per floor: 1

Floor levels: 9

Main riser diameter: ?

According to diagram ①

Main riser diameter: 125 mm

Example 2:

Type of room: Bathroom and separate toilet with 1 unit or kitchen ventilation

$\dot{V} = 100 \text{ m}^3/\text{h}$ (Bathroom 60 m³/h and toilet 40 m³/h)

Units per floor: 2

Floor levels: 6

Main riser diameter: ?

According to diagram ④

Main riser diameter: 200 mm

ELS inner facia and flush mounted casing

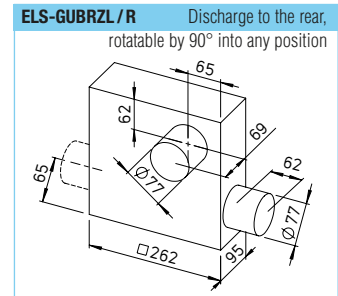
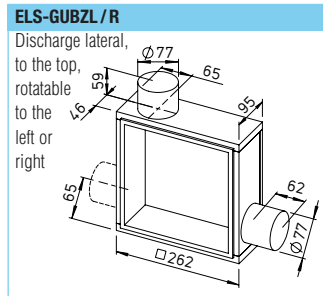
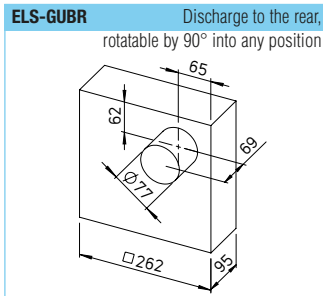
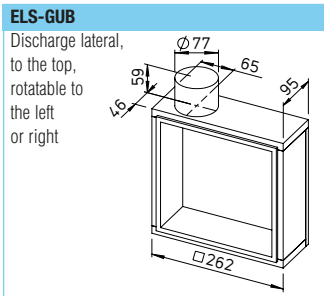
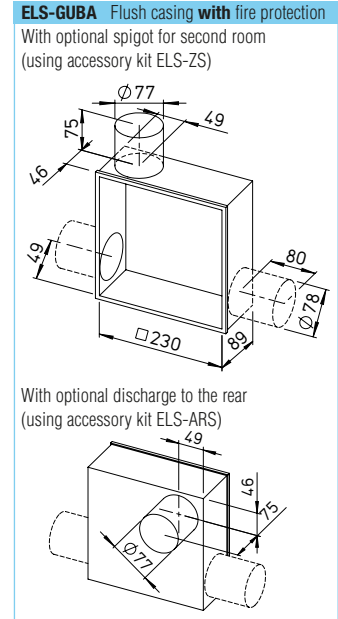
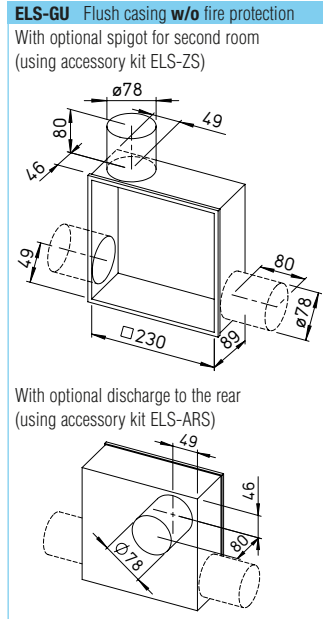
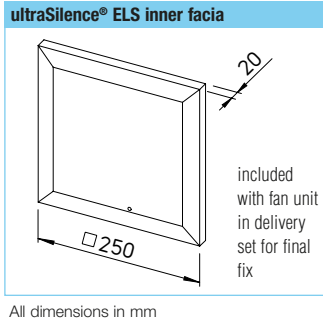

Surface mounted unit and surface mounted casing

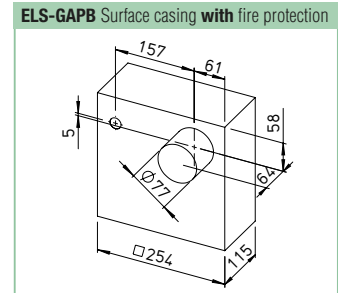
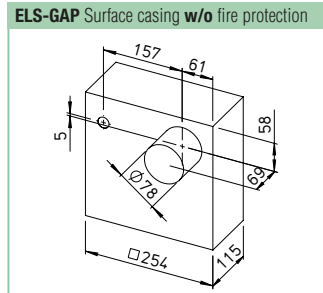
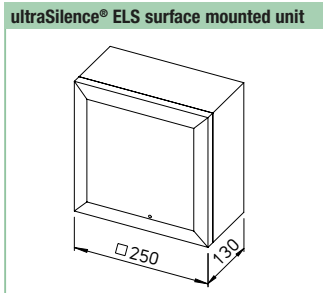

Technical data	Fan unit													
	ELS	-V 60	-VN 60	-VNC 60	-VP 60	-VF 60	-V 60/35	-VN 60/35	-VF 60/35	-V 100	-VN 100	-VNC 100	-VP 100	-VN 100/60
Ref. no.	8131	8137	8143	8149	8161	8133	8139	8163	8132	8138	8144	8150	8141	8136
Run on time, approx. min.	—	6, 15, 21	6, 10, 15, 21	15	6, 10, 15, 21	—	6, 15, 21	6, 10, 15, 21	—	6, 15, 21	6, 10, 15, 21	15	6, 15, 21	—
Interval operation, hrs.	—	—	4, 8, 12, 24	—	—	—	—	—	—	—	4, 8, 12, 24	—	—	—
Air flow volume approx. m³/h	60	60	60	60	60	60/35	60/35	60/35	100	100	100	100	100/60	100/60/35
Power consumption approx. Watt	18	18	18	18	18	18/9	18/9	18/9	29	29	29	29	29/18	29/18/9
Sound pressure level approx. dB(A) at 10 m² equivalent absorption surface														
flush ¹⁾	35	35	35	35	35	35/26	35/26	35/26	47	47	47	47	47/35	47/35/26
surface	39	39	39	39	39	39/30	39/30	39/30	51	51	51	51	51/39	51/39/30
Sound power level L _{wa} approx. dB(A)														
flush ¹⁾	39	39	39	39	39	39/30	39/30	39/30	51	51	51	51	51/39	51/39/30
surface	43	43	43	43	43	43/34	43/34	43/34	55	55	55	55	55/43	55/43/34
Electric. connection: 230 V~, 50 Hz	NYM-0	NYM-0	NYM-0	NYM-0	NYM-0	NYM-0	NYM-0	NYM-0	NYM-0	NYM-0	NYM-0	NYM-0	NYM-0	NYM-0
Electrical power supply in mm²	2 x 1,5	3 x 1,5	3 x 1,5	2 x 1,5	3 x 1,5	3 x 1,5	4 x 1,5	4 x 1,5	2 x 1,5	3 x 1,5	3 x 1,5	2 x 1,5	4 x 1,5	4 x 1,5
Protection class II without PE			4 x 1,5*		4 x 1,5*			5 x 1,5*						
Wiring diagram no.	SS-869	SS-875	SS-881	SS-887	SS-881	SS-871	SS-877	SS-883	SS-870	SS-876	SS-882	SS-887	SS-879	SS-874

All power and noise data according to DIN 24163, DIN 24166, DIN 45635, DIN 44974.

¹⁾ in combination with casing type ELS-GU, discharge lateral.

* for deactivation of automatic function.

Central ventilation system ZLS-DV EC according to DIN 18017-3.

Residential ventilation to DIN 18017-3

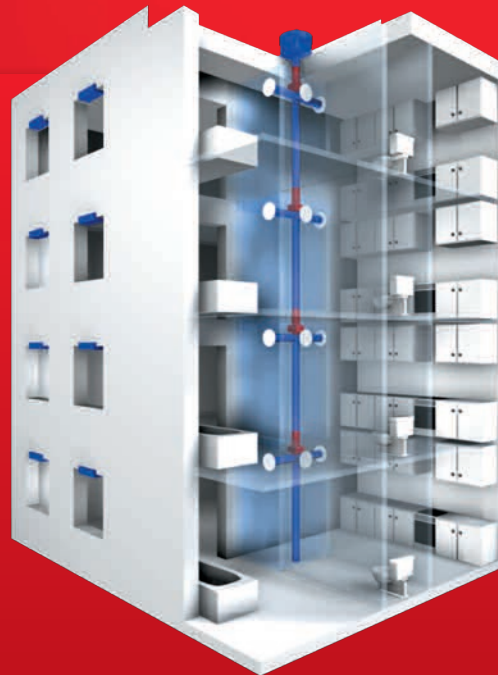

ZLS-DV EC is the ideal central ventilation system in multi-storey construction according to DIN 18017-3.

- Humid, polluted air is extracted in line with requirements. At the same time, the pressure-controlled controller integrated in the fan guarantees that a set negative pressure is maintained. Thus, the planned air flow volume remains unchanged in all other rooms.
- Energy-saving EC technology with highest efficiency, even for controlled operation, and up to 50 % energy saving in comparison with conventional motors.

EXTRACT AIR



The roof fan is connected to the central exhaust shaft. The extract air from wetrooms and kitchens leaves via extract air elements with demand-oriented function. The automatic, stepless power adjustment takes place via the integrated pressure sensor.

66^{on}

OUTSIDE AIR

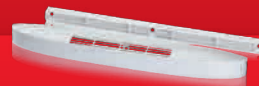

Draught-free outside air is supplied to the living and bedrooms via automatic elements for window or wall installation.

68

FIRE PROTECTION



The spread of fire to other floors is prevented according to building requirements in the classified and unclassified shaft.

69

DV EC

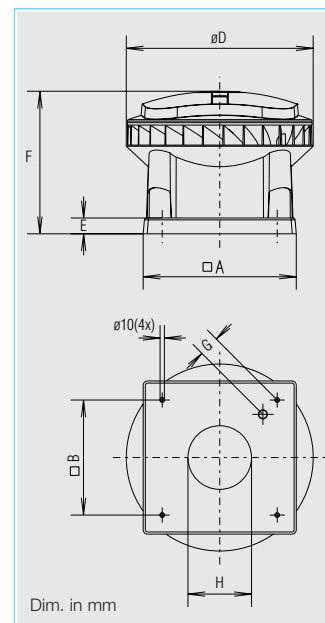

Dim. in mm

up to **45% Saving***
* with speed control

Extremely weather-resistant, polymer EC roof fan for an extensive area of application, diagonal discharge.

Similarities DV EC Pro and DV EC Eco

Casing
Aerodynamically designed casing from high-quality polypropylene in grey with diagonal air discharge. Air flow temperatures from -30 to +60 °C.

Impeller
Diagonal impeller made from aluminium, the motor-impeller unit is dynamically balanced for low noise operation.

Motor
Energy-efficient EC external rotor motor protected to IP 54. Optimised level of efficiency for speed control for low operating costs. Steplessly speed controllable. Maintenance-free and interference-free, ball bearing mounted.

Motor protection
Integrated electronic temperature monitoring for EC motor and electronics.

Electrical connection
Standard external terminal box (protection class IP 65) on casing. Connection voltage 1 ph., 230 V, 50 Hz.

Installation
Horizontal installation on the roof. In case of pitched roofs, a suitable base must be provided to prevent water entry. Extensive accessories facilitate the assembly of the fan to the ducting system in the building.

Sound levels
Total sound power levels and the spectrum figures in dB(A) are given for:
- Sound power intake
- Sound power exhaust
You can also find sound pressure levels at 4 m (free field conditions) in the table below and below the performance curve.

Specification DV EC Pro

- Speed control**
 - Ideal as central exhaust air fan for multi-storey building according to DIN 18017-3.
 - In connection with other components (accessories), a complete central ventilation system can be developed according to DIN 18017-3 with demand-driven ventilation.
 - Integrated pressure control for air flow volume stabilisation in the connected rooms by automatic speed adaptation with almost constantly good level of efficiency.
 - Integrated pressure sensor 0-300 Pa.
 - Short pay back time due to high energy conservation.
 - Four potentiometers integrated in the control permit an adjustment to the operating data. The desired operating point can be set directly on site.
 - Integrate serial Bus port (RS 485) for connection of a PC/laptop in combination with the interface (accessories).

Dimensions in mm			
Type	DV EC 200	DV EC 250	DV EC 400
□ A	460	580	665
□ B	330	450	535
∅ D	575	708	863
E	60	60	60
F	473	540	601
G	44	48	64
H	196	241	302

Specification DV EC Eco

- Speed control**
 - Stepless speed control with a speed-potentiometer PU/PA 10 (accessories, see table below).
 - In connection with the universal control system EUR EC or electronic pressure/temperature controllers EDR/ETR (accessories, see table below), the fan can be used for stepless differential pressure, differential temperature or flow velocity regulation. For example, the performance levels are shown in the performance curves.

Type	Ref. no.	Maximum R.P.M. approx.	Air flow volume (FID)	Sound pressure case breakout	Power consumption at maximum R.P.M.		Wiring diagram	max. air flow temperature	Weight net approx.	Timer / Universal control system		Speed-potentiometer surface flush			
					kW	A				Type	Ref. no.	Type	Ref. no.	Type	Ref. no.
Type DV EC Pro, 1 ph. motor, 230 V, 50/60 Hz, EC motor, IP 54											Timer				
DV EC 200 Pro	8385	1810	2010	52	0.18	1.38	863.1	60	17.0	ZLS-ZU 31	8388	—	—	—	—
DV EC 250 Pro	8386	1640	3700	60	0.41	1.78	863.1	60	23.0	ZLS-ZU 31	8388	—	—	—	—
DV EC 400 A Pro	8387	1020	4070	51	0.30	1.33	863.1	60	33.0	ZLS-ZU 31	8388	—	—	—	—
DV EC 400 B Pro	8389	1425	5650	65	0.75	3.32	863.1	60	35.0	ZLS-ZU 31	8388	—	—	—	—
Type DV EC Eco, 1 ph. motor, 230 V, 50/60 Hz, EC motor, IP 54											Control system				
DV EC 200 Eco	8320	1810	2010	52	0.18	1.38	991	60	17.0	EUR EC ⁽¹⁾²⁾	1347	PU 10 ³⁾	1734	PA 10 ³⁾	1735
DV EC 250 Eco	8322	1640	3700	60	0.41	1.78	991	60	23.0	EUR EC ⁽¹⁾²⁾	1347	PU 10 ³⁾	1734	PA 10 ³⁾	1735
DV EC 400 A Eco	8324	1020	4070	51	0.30	1.33	991	60	33.0	EUR EC ⁽¹⁾²⁾	1347	PU 10 ³⁾	1734	PA 10 ³⁾	1735
DV EC 400 B Eco	8326	1425	5650	65	0.75	3.32	991	60	35.0	EUR EC ⁽¹⁾²⁾	1347	PU 10 ³⁾	1734	PA 10 ³⁾	1735

¹⁾ Several EC fans can normally be connected

²⁾ alternative electronic pressure/temp. controller (EDR/ETR, No. 1437/1438) in connection with power supply NG24, No. 1439, see Accessories

³⁾ without LED power supply

DV EC 200

Frequency		Hz	Total	125	250	500	1k	2k	4k	8k
L _{WA}	Intake	dB(A)	70	54	64	64	65	61	55	46
L _{WA}	Exhaust	dB(A)	72	53	57	66	69	66	57	46

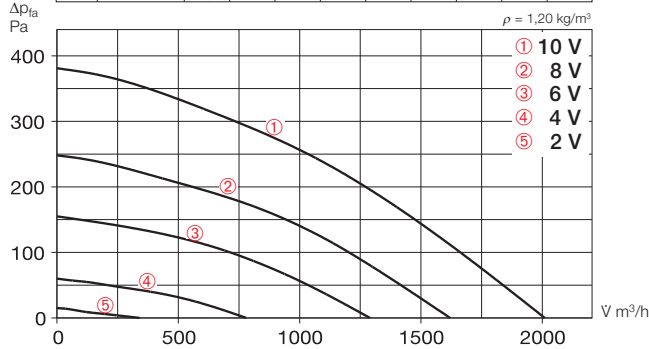

Voltage V	n min ⁻¹	\dot{V} m ³ /h	P W	I A	Lp dB(A)	SFP kW/m ³ /s
10	1810	2010	180	1.38	52	—
8	1480	1620	108	0.90	47	—
6	1200	1290	60	0.54	41	—
4	720	780	21	0.20	31	—

DV EC 250

Frequency		Hz	Total	125	250	500	1k	2k	4k	8k
L _{WA}	Intake	dB(A)	75	60	64	70	69	67	61	52
L _{WA}	Exhaust	dB(A)	80	63	65	75	76	72	63	52

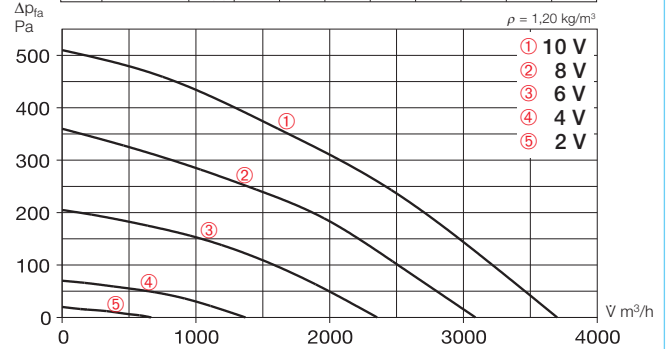

Voltage V	n min ⁻¹	\dot{V} m ³ /h	P W	I A	Lp dB(A)	SFP kW/m ³ /s
10	1640	3700	412	1.78	60	—
8	1380	3100	264	1.14	55	—
6	1100	2350	138	0.60	49	—
4	650	1370	40	0.20	36	—

DV EC 400 A

Frequency		Hz	Total	125	250	500	1k	2k	4k	8k
L _{WA}	Intake	dB(A)	68	55	62	63	63	58	51	44
L _{WA}	Exhaust	dB(A)	72	56	61	68	67	60	52	43

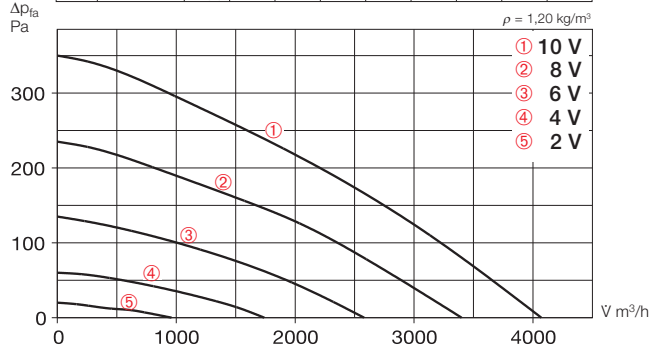

Voltage V	n min ⁻¹	\dot{V} m ³ /h	P W	I A	Lp dB(A)	SFP kW/m ³ /s
10	1020	4070	303	1.33	51	—
8	850	3400	176	0.77	46	—
6	650	2580	85	0.40	40	—
4	450	1740	33	0.20	31	—

DV EC 400 B

Frequency		Hz	Total	125	250	500	1k	2k	4k	8k
L _{WA}	Intake	dB(A)	80	64	69	75	74	74	65	58
L _{WA}	Exhaust	dB(A)	85	66	72	82	81	76	66	56

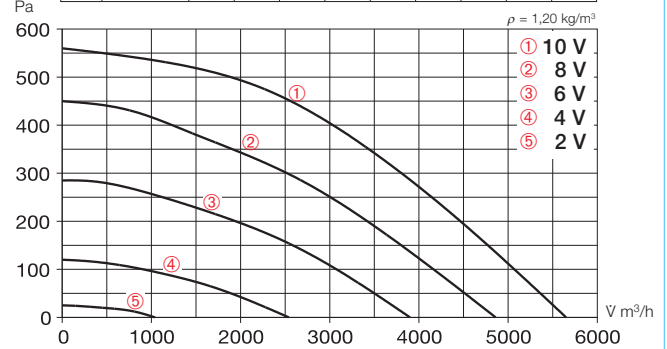

Voltage V	n min ⁻¹	\dot{V} m ³ /h	P W	I A	Lp dB(A)	SFP kW/m ³ /s
10	1425	5650	755	3.32	65	—
8	1225	4860	485	2.10	60	—
6	1000	3900	265	1.15	54	—
4	650	2540	90	0.40	43	—

Extract air



AE
Ready-to-install extract air element with polymer mounting ring.
To be inserted into ducting with diam. 125 mm. With demand-based and standard ventilation stages, electrical, humidity, motion and time controlled for use pursuant to the following table.
Types AE and AE GB with self-regulating air flow volume stabilisation. Humidity controlled types AE Hygro or type AE FV with filter and air flow volume control are preferable for kitchens and bathrooms.
Adapter filter element VFE
For installation in front of AE, if room air is polluted and greasy. See product page for details.

– Fire protection shutters for extract air elements AE



– Cold smoke shutter KAK



– Noise reduction element SVE (also suitable for supply air)



Overflow



Intake air elements

– Installation in wall openings



ZL
Universal supply air unit and thermostatic valve for controlled air intake regulation.
See intake air element product pages for detailed descriptions.

– Installation in window frames



ALEF
Intake air element with air flow volume control and limiter. See intake air element product pages for detailed descriptions. Ideally suitable for retrofitting and new construction.

Bathroom		Toilet		Kitchen	
Type	Ref. no.	Type	Ref. no.	Type	Ref. no.
Extract air element with self-regulating air flow volume stabilisation * Air flow volume in m³/h					
AE 45*	2031	AE 30*	2030	AE 75*	2033
As above, but with two air flow volumes (demand-based and standard ventilation)					
AE GB 20/75*	2036	AE GB 15/30*	2035	AE GB 45/120*	2038
As AE GB, with additional electr. timer (without air flow volume stabilisation)					
AE GBE 30/60*	2047	AE GBE 15/30*	2044	AE GBE 45/120*	2048
As AE GBE, but with motion sensor					
		AE B 15/30*	2055		
Humidity controlled extract air unit with variable, limited air flow volume					
AE Hygro 10/45*	2049				
As AE Hygro, with additional electrically controlled demand-based ventilation stage					
AE Hygro GBE 5/40/75*	2053			AE Hygro GBE 10/45/120*	2054
Extract air element AE FV, with filter and air volume control					
AE FV 125	9478			AE FV 125	9478
Adapter filter element VFE					
– to AE / AE GBE, AE Hygro, prevents contamination of the air extract element and ducting system					
				VFE 70/VFE 90	2552/2553

Fire and smoke shutter.

Suitable for insertion into spiral ducting without additional mounting frame or wall installation with mounting sleeve EH (accessories).

Cold smoke shutter with magnetic closure. Prevents backflow of cold smoke into other fire areas in central ventilation system.

* ND 125, suitable for AE above. See product pages for other ND and detailed descriptions.

Type	Ref. no.
Fire protection shutter K 90-18017	
BAE 125*	2626
Fire protection shutter K 90-4102	
BAK 125*	2621
Mounting sleeve (accessories for both types)	
EH 125*	2640
Cold smoke shutter	
KAK 125*	4098

Noise reduction elements for simple noise-absorption and air volume regulation in central ventilation systems through duct insertion. Also suitable for pressure regulation.

Door grilles

Discreet, screened ventilation grille made from impact-resistant polymer for door installation.

Type SVE 100	Ref. no. 8310
ND 100 mm	
Type SVE 125*	Ref. no. 8311
ND 125 mm	
Type LTGW	Ref. no. 0246
Made from white polymer.	
Type LTGB	Ref. no. 0247
Made from brown polymer	

	Ø 80		Ø 100		Ø 160	
Type	Ref. no.	Type	Ref. no.	Type	Ref. no.	
Supply air unit – Automatic temperature control incl. thermostatic valve, acoustic lining and external grille						
	ZLA 80	0214	ZLA 100	0215	ZLA 160	0216
Supply air element – Manual control in four stages incl. valve plate with pull cord, sound insulation and external grille						
			ZLE 100	0079		
Thermostatic valve – For installation in existing ventilation openings						
	ZTV 80	0078	ZTV 100	0073	ZTV 160	0074

V					
m³/h	Type	Ref. no.	Type	Ref. no.	Type
Intake air inlet element for installation in window frames – with air volume control and limiter					
30	ALEF 30	2100			ALEFS 30
45	ALEF 45	2101			ALEFS 45
Intake air inlet element for installation in window frames – humidity control, with air volume control and limiter					
6/45	ALEF Hygro 6/45	2056			ALEFS Hygro 6/45

Flange connecting plate

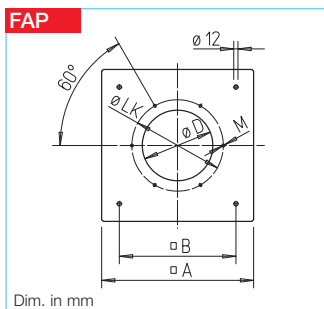

Flange connecting plate FAP
Made from galvanised sheet steel. Allows the connection of the duct system and accessories to the roof fans DV EC, if no base attenuator SSD is used.

Type	FAP 200	FAP 250	FAP 400
Ref. no.	8382	8383	8384
□ A mm	430	550	635
□ B mm	330	450	535
∅ D mm	200	250	400
∅ LK mm	259	286	438
M	M 6	M 6	M 8
Weight kg	1.8	3.0	3.3

Flange, flanged flexible connector



Suitable for roof fan:					
DV EC 200		DV EC 250		DV EC 400	
Type	Ref. no.	Type	Ref. no.	Type	Ref. no.
Flange connecting plate – necessary for duct connection					
FAP 200	8382	FAP 250	8383	FAP 400	8384
Counterflange					
DFR 200	1201	FR 250	1203	FR 400	1206
Flanged flexible connector					
DSTS 200	1218	STS 250	1220	STS 400	1223

See product pages for detailed descriptions.

Flat roof base



Suitable for roof fan:					
DV EC 200		DV EC 250		DV EC 400	
Type	Ref. no.	Type	Ref. no.	Type	Ref. no.
Flat roof base – with hinge mechanism for easy maintenance					
FDS 200	1378	FDS 250	1379	FDS 400	1380
Base attenuator – with hinge mechanism for easy maintenance					
SSD 200	5290	SSD 250	5292	SSD 400	5291

See product pages for detailed descriptions.

Base attenuator

Fire protection



Fire damper ELS-D prevents spread of fire to other floors.
Installation in ventilation main duct to DIN 18017 K90. Maintenance free. Approved for use in ventilation shafts or mixed service shafts (even with flammable ducts) only needs to be covered with 12.5 mm plaster-

board cover. All other parts (valves etc.) do not need fire protection classification. Flexible aluminium ducting can be used for the connections. Shutters KAK are to be provided to avoid backflow of cold smoke (see left page).

ND mm main duct	100	125	140	160	180	200
Type	ELS-D 100	125	140	160	180	200
Ref. no.	0270	0185	0186	0187	0188	0271

Control



Interface
Interface for the start-up and/or control of the fan in connection with a PC/Laptop. Power supply unit, adaptor cable and software included.

Type ZLS-IF Ref. no. 8391

Electronic timer module with day/night regulator
Allows parallel operation of max. 31 DV EC roof fans. The rocker main switch activates the timer module. The day and night regulation is carried out via the settings on the display.
Incl. main switch. 230 V, 50 Hz.
Type ZLS-ZU 31 Ref. no. 8388

Accessory details	Page
Roof installation accessories	485
Ventilation grilles	487 on
Extract air elements	500 on
Intake air elements	512 on
Fire protection systems	
– Fire damper	516 on
Universal control systems, electronic controllers, speed-potentiometer	539 on



Universal control system
For stepless control or regulation of single or three phase EC fans with a setpoint of 0-10 V DC:
Type EUR EC Ref. no. 1347



Speed-potentiometer
For direct control/setpoint setting of EC fans with potentiometer inputs.
Type PU 10 (up) Ref. no. 1734

Type PA 10 (ap) Ref. no. 1735

Compact central ventilation systems for energy-saving application in residential and commercial buildings.

ZEB EC.

The powerful energy-saving box – ideal in low energy houses or in multi-storey buildings.

Passive and low energy houses set the standard with regard to the insulation and impermeability of building envelopes. The compliance with provisions must be proven by a special test upon a building inspection. In order to comply with the Energy Savings Ordinance (EnEV), ventilation units with highest efficiency levels must be used in full load and controlled operation.

A prerequisite for a pleasant room climate and maintaining structurally-sound buildings is extraction of humidity, odorous and pollutant substances, as well as the draught-free, controlled introduction of fresh outside air.

The ZEB system fulfils this task perfectly. Whether in a single family house, the floor-by-floor extraction of residential units through a common central shaft (DIN 18017-3) or in commercial applications.

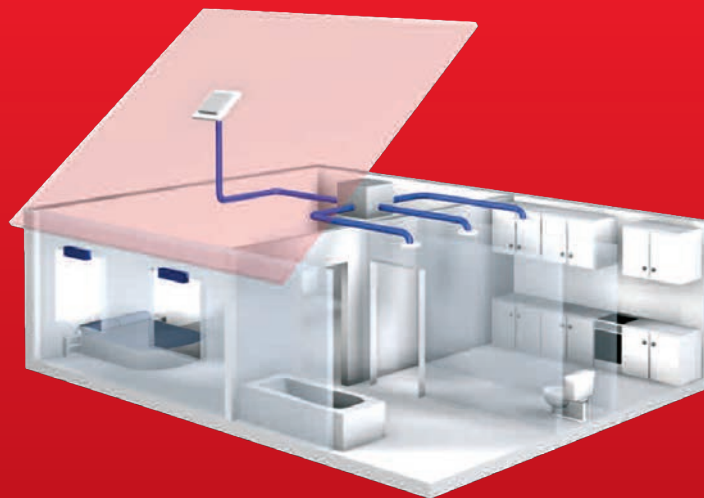

EXTRACT AIR

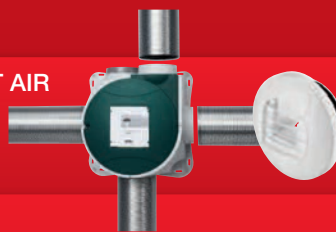

ZEB as an extract air box positioned under the roof or in an adjoining room. Manual or automatic operation, i.e. time-dependent on basic, normal or peak demand.

The extract air is extracted from used rooms, such as kitchens, bathrooms and toilets. Innovative extract air elements allow a constant or demand-driven air flow volume, tuned to individual user requirements or space requirements. The ducting system is created with commercial spiral ducting.

72

OUTSIDE AIR EXHAUST AIR



The outside air gradually flows in via differential pressure controlled intake air elements, which are to be installed in the walls or windows of living rooms or bedrooms.

Overflow elements ensure air circulation within the room unit.

The exhaust air is discharged outside via a roof or wall outlet.

74

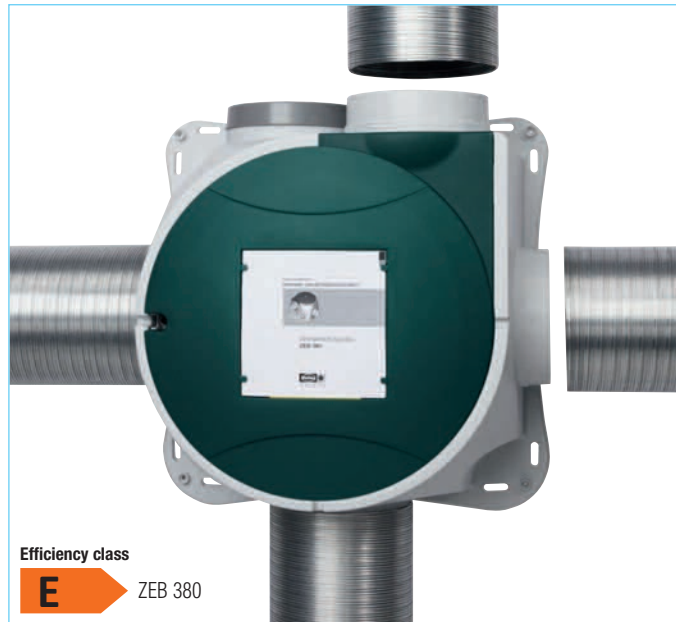

Efficiency class
E ZEB 380

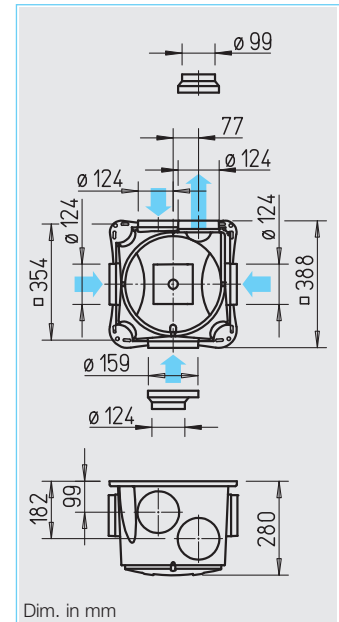

■ **Compact ventilation box with four spigots for connecting extract air ducting.**
For various private, commercial and industrial applications.

■ **Operation**

- As central extraction unit for several rooms or areas.
- For apartment ventilation according to DIN 18017. Extraction in e.g. kitchens, bathrooms, toilets in multiple apartments with central main duct in multi-storey construction. Extraction in multiple rooms (e.g. living room, kitchen, bathroom, toilet) in one apartment. Easy installation (in any position) in storerooms or below the roof.
- For commercial and industrial applications to ventilate humid rooms, toilet facilities, extraction of vapour in workplace, etc.

■ **Casing**

- Robust casing made from impact-resistant polymer, light-grey.
- The three intake spigots and the one discharge spigot are designed for ducting size 100 and 125 mm. One intake spigot is designed for ducting size 100, 125 and 160 mm.

■ **Impeller**

- Low-noise centrifugal impeller made from steel in aerodynamically optimised spiral. Inlet via bell mouth.

■ **Motor**

- Totally enclosed, ball bearing mounted external rotor motor protected to IP 44, with humidity protection, insulation class B, for permanent operation, maintenance-free and interference-free.
- Motor/impeller unit removable for cleaning and service with one grip.

■ **Motor protection**

- Motor protection through built-in thermal contacts, wired in series with the windings, automatic switch off and reset after cooling.

■ **Electrical connection**

- Service and installation friendly. Delivered ready to operate with cable pre-wired terminal box.
- For 3 speed operation NYM-J 5x1.5 mm² required.

■ **Speed control**

- Variable power adjustment through 3 speeds by means of operating switch (accessories).

■ **Installation**

- Without restriction in any position. To reduce noise levels in ventilated rooms install unit as remotely as possible.

■ **Ducting**

The ducting used may be rigid spiral ducting, flexible aluminium or even polymer ducting. When crossing fire sections, fire protection regulations must be considered.

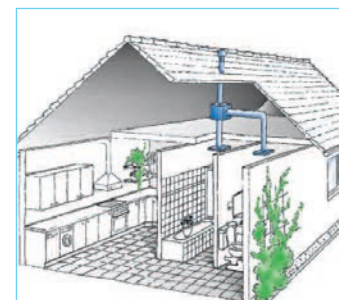

Accessories	Page
Overview	74
Accessory details	Page
Flexible ducting, roof ducts, shutters and grilles	487 on
Extract air elements	500 on
Intake air elements	512 on
Fire protection elements for use in multi-stor. con.	516 on
Controllers	525 on

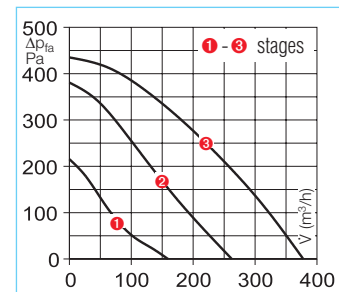

Type	ZEB 380
Ref. no.	1456
Air flow volume m ³ /h*	380/260/160
R.P.M. min ⁻¹ approx.	max. 2730
Voltage/Frequency	230 V-, 50 Hz
Power consumption max. W*	67/38/20
Nominal current max. A*	0.28/0.23/0.17
Sound pressure level, case breakout at 4 m*	33/26/19
L _{WA} intake dB(A)*	62/57/45
L _{WA} exhaust dB(A)*	69/63/52
Wiring diagram no.	908
Max. permissible temperature °C	+40
Weight approx. kg	5.9

* Values refer to the three performance stages (see performance curve).

■ **Accessories**

Three speed operation and operating switch with 0 position.

Convenient flush mounted speed controller. Room light not switchable in parallel. Installation in flush switch box. Dim. mm (WxHxD) 80 x 80 x 23
Type DSEL 3 Ref. no. 1611



Week timer

Digital timer with LCD display for autom. control of operation, all weekdays are programmable. For flush and surface mounting. Dim. mm (WxHxD) 85 x 85 x 52
Type WSUP Ref. no. 9990



For switch cabinet installation (2 space units required). Dim. mm (WxHxD) 36 x 90 x 69
Type WSUP-S Ref. no. 9577

■ **ZEB with EC technology** – because of the DC motors, the EC version of the ZEB has become the “energy-saving ventilation box”, which is ideally designed for operation in a low energy house. Brushless DC motors operate with extremely low losses and thus with higher efficiency than conventional motors, even on controlled operation. This results in convincing advantages:

- Short pay back period due to high energy savings.
- Simple and convenient speed control in nine possible performance stages.

■ **Operation**

- For controlled residential ventilation according to DIN 18017-3 and DIN 1946-6.
- Ideal in low energy houses.
- For ventilation with a common main duct in houses, apartments and multi-storey buildings.

■ **Casing**

- Robust casing made from impact-resistant polymer, light-grey.
- The three intake spigots and the one discharge spigot are designed for ducting size 100 and 125 mm. One intake spigot is designed for ducting size 100, 125 and 160 mm.

■ **Impeller**

- Low-noise centrifugal impeller made from steel in aerodynamically optimised spiral. Inlet via bell mouth.

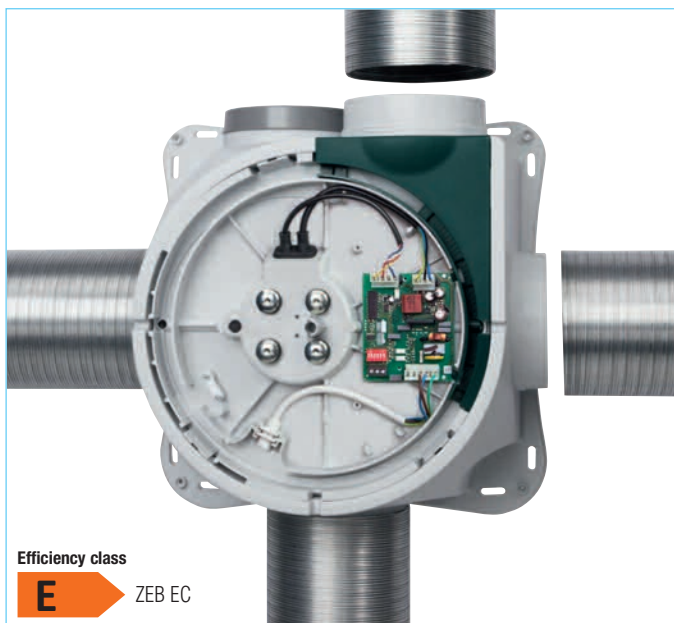

Efficiency class **E** ZEB EC

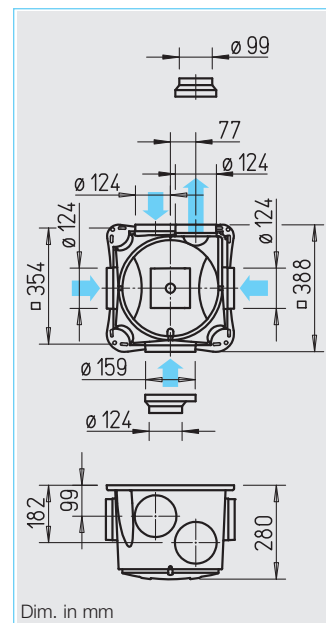

■ **Motor**

- DC motor, electronically commutated, with high efficiency even during controlled operation. Ball bearing mounted external rotor motor protected to IP 44 for permanent operation, maintenance-free and interference-free.
- Motor/impeller unit removable for cleaning and service with one grip.

■ **Motor protection**

- An integrated thermal element monitors the temperature of the windings in conjunction with the built-in electronic circuit.

■ **Electrical connection**

- Service and installation friendly. Delivered ready to operate with terminal box.
- Connection directly to 230 V supply.
- For 3 speed operation NYM-J 5x1.5 mm² required.

■ **Speed control**

- Fan operation in three stages by means of operating switch (accessories). For individual performance adjustment, 9 speeds can be

selected with Dip-switches in the electronic unit.

■ **Installation**

- Without restriction in any position. To reduce noise levels in ventilated rooms install unit as remotely as possible.

■ **Ducting**

The ducting used may be rigid spiral ducting, flexible aluminium or even polymer ducting. When crossing fire sections, fire protection regulations must be considered.

■ **Accessories**

Three speed operation and operating switch with 0 position.

Convenient flush mounted speed controller. Room light not switchable in parallel. Installation in flush switch box. (min. depth 55 mm). Dim. mm (WxHxD) 80 x 80 x 23

Type DSZ Ref. no. 1598

Week timer

Digital timer with LCD display for autom. control of operation, all weekdays are programmable. For flush and surface mounting. Dim. mm (WxHxD) 85 x 85 x 52

Type WSUP Ref. no. 9990

For switch cabinet installation (2 space units required). Dim. mm (WxHxD) 36 x 90 x 69

Type WSUP-S Ref. no. 9577

Electronic control system

For stepless control or regulation of single and three phase EC fans. Dim. mm (WxHxD) 223 x 200 x 131

Type EUR EC Ref. no. 1347

Three-step switch 10 V / 0-10 V

For the three-step control of EC fans or frequency inverters, with a 0-10 V DC control input. For flush and surface mounting. Dim. mm (WxH) 80 x 80

SU-3 10/SA-3 10 No. 4266/4267

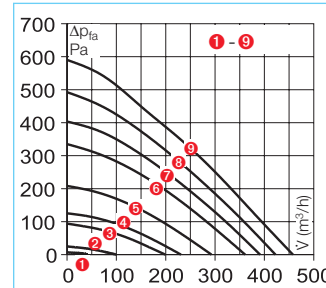
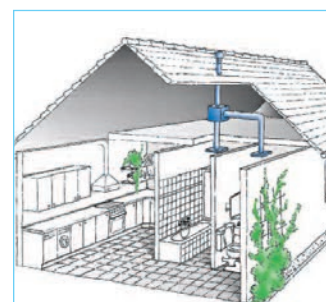

Fig. WSUP

Type	ZEB EC
Ref. no.	1457
Air flow volume m ³ /h*	460/430/400/360/300/230/200/100/40
R.P.M. min ⁻¹ approx.	max. 3200
Voltage/Frequency	230 V-, 50 Hz
Power consumption max. W*	69/55/44/34/19/11/8/3/2
Nominal current max. A*	0,58/0,47/0,38/0,30/0,18/0,10/0,08/0,04/0,04
Sound pressure level, case breakout at 4m*	37/36/34/32/27/21/<20/<20/<20
L _{WA} intake dB(A)*	65/63/62/61/57/53/47/37/34
L _{WA} exhaust dB(A)*	74/72/70/68/62/57/54/39/26
Wiring diagram no.	1115
Max. permissible temperature °C	+40
Weight approx. kg	5,9

* Values refer to the nine performance stages (see performance curve).

Extract air



Ready-to-install extract air element with polymer mounting ring.

To be inserted into ducting with diam. 125 mm. With demand-based and standard ventilation stages, electrical, humidity, motion and time controlled for use pursuant to the following table. Types AE and AE GB with self-regulating air flow volume stabilisation. Humidity controlled types AE Hygro or type AE FV with filter and air flow volume control are preferable for kitchens and bathrooms.

Adapter filter element VFE
For installation in front of AE, if room air is polluted and greasy. See product page for details.

Bathroom		Toilet		Kitchen	
Type	Ref. no.	Type	Ref. no.	Type	Ref. no.
Extract air element with self-regulating air flow volume stabilisation * Air flow volume in m³/h					
AE 45*	2031	AE 30*	2030	AE 75*	2033
As above , but with two air flow volumes (demand-based and standard ventilation)					
AE GB 20/75*	2036	AE GB 15/30*	2035	AE GB 45/120*	2038
As AE GB , with additional electr. timer (without air flow volume stabilisation)					
AE GBE 30/60*	2047	AE GBE 15/30*	2044	AE GBE 45/120*	2048
As AE GBE , but with motion sensor					
		AE B 15/30*	2055		
Humidity controlled extract air unit with variable, limited air flow volume					
AE Hygro 10/45*	2049				
As AE Hygro , with additional electrically controlled demand-based ventilation stage					
AE Hygro GBE 5/40/75*	2053			AE Hygro GBE 10/45/120*	2054
Extract air element AE FV , with filter and air volume control					
AE FV 125	9478			AE FV 125	9478
Adapter filter element VFE					
– to AE / AE GBE, AE Hygro, prevents contamination of the air extract element and ducting system					
				VFE 70/VFE 90	2552/2553

Extract air (alternative to AE)



Automatic air flow volume stabiliser to be inserted into ducting and duct components. For constant air flow with a differential pressure range of approx. 50–250 Pa.

∇	Ø 80		Ø 100		Ø 125	
m³/h	Type	Ref. no.	Type	Ref. no.	Type	Ref. no.
15-50	VKH 80/15-50	0001	VKH 100/15-50	0002	VKH 125/15-50	0004
50-100			VKH 100/50-100	0003	VKH 125/50-100	0005
100-180					VKH 125/100-180	0006



Noise reduction element inserted into ducting for simple sound insulation and volume control. Also for pressure regulation.

Ventilation grilles and valves elegant, especially for living spaces.

	Ø 80		Ø 100		Ø 125	
	Type	Ref. no.	Type	Ref. no.	Type	Ref. no.
Noise reduction element						
	SVE 80	8309	SVE 100	8310	SVE 125	8311
Ventilation grille (to put before/cover types VKH and SVE)						
	LGK 80	0259	LGM 100	0254	LGM 125	0258
Polymer valve for extraction						
	KTVA 75/80	0940	KTVA 100	0941	KTVA 125	0942

Intake air elements

– Installation in wall openings

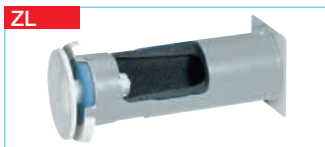

Universal supply air unit and thermostatic valve for controlled air intake regulation. See intake air element product pages for detailed descriptions.

	Ø 80		Ø 100		Ø 160	
	Type	Ref. no.	Type	Ref. no.	Type	Ref. no.
Supply air unit – Automatic temperature control incl. thermostatic valve, acoustic lining and external grille						
	ZLA 80	0214	ZLA 100	0215	ZLA 160	0216
Supply air element – Manual control in four stages incl. valve plate with pull cord, sound insulation and external grille						
			ZLE 100	0079		
Thermostatic valve – For installation in existing ventilation openings						
	ZTV 80	0078	ZTV 100	0073	ZTV 160	0074

– Installation in window frames



Intake air element with air flow volume control and limiter. See intake air element product pages for detailed descriptions. Ideally suitable for retrofitting and new construction.

∇				
m³/h	Type	Ref. no.	Type	Ref. no.
Intake air inlet element for installation in window frames – with air volume control and limiter				
30	ALEF 30	2100	ALEFS 30	2102
45	ALEF 45	2101	ALEFS 45	2103
Intake air inlet element for installation in window frames – humidity control, with air volume control and limiter				
6/45	ALEF Hygro 6/45	2056	ALEFS Hygro 6/45	2057

Ducts, duct components

Ducts, duct components



Ø 80		Ø 100		Ø 125	
Type	Ref. no.	Type	Ref. no.	Type	Ref. no.
Fully flexible ducting					
ALF 80	5711	ALF 100	5712	ALF 125	5713
Duct connector – made from galvanised sheet steel					
RVB 80	5993	RVB 100	5994	RVB 125	5995
Worm drive clips – metal band with a snap on tension lock, contents = 10 pcs.					
SCH 80	5722	SCH 100	5722	SCH 125	5723
T-pieces – made from galvanised sheet steel					
		TS 100	1479	TS 125	5720

Reduction



Ø 80		Ø 100		Ø 125	
Type	Ref. no.	Type	Ref. no.	Type	Ref. no.
Duct reducers – made from polymer					
		RZ 100/80	5223	RZ 125/100	5222
Flexible attenuator – from flexible aluminium duct					
		FSD 100	0676	FSD 125	0677
Backdraught shutter – automatic, made from polymer					
		RSKK 100	5106	RSKK 125	5107
Backdraught shutter – airtight, for duct insertion					
RVE 80	2584	RVE 100	2587	RVE 125	2588

Attenuator, backdraught shutter



Wall and roof openings

DH, UDP, FDP



Ø 80		Ø 100		Ø 125	
Wall mounting kit – to put air intakes and outlets through walls					
		TMK 100	0844	TMK 125/150	0845
Universal roof outlet* DDF – adaptable to all kind of roof tiles, for pitched roofs and flat roofs.					
				DDF 125	1964
Roof outlet, plates for ridged roof/flat roofs and connector (see Figure on left)					
– Roof outlet*		DH 100 S	2015	DH 125 S	2017
– Pitched roof universal pan tile*		UDP 100 S	2021	UDP 125 S	2021
– Flat roof pan tile		FDP 100	2024	FDP 125	2013
– Connector		STV 100	2026	STV 125	2027

* See product page for other colours.

Overflow

LTG



Door grilles

Discreet, screened ventilation grille made from impact-resistant polymer for door installation. See ventilation grilles product page for detailed descriptions.

Type LTGW Ref. no. 0246
Made from white polymer.

Type LTGB Ref. no. 0247
Made from brown polymer.

Information	Page
Dimensions, more detailed technical data and other parameters:	
Grilles,	
ducting, moulded parts,	
Roof outlets	487 on
Extract air elements	500 on
Intake air elements	512 on
Fire protection elements	
for use in multi-stor. con.	516 on
Controllers	525 on

A comfortable climate and energy saving.
For low-energy / passive house standard,
multi-storey buildings and commercial
applications.



The compact wall units

KWL EC 200 W to KWL EC 500 W and the ultra-flat **ceiling units** KWL EC 220 D and KWL EC 340 D are equipped with Helios easyControls as standard. They therefore redefine the standard for the operation of KWL® devices.

Thanks to the integrated web server and LAN connection, the ventilation devices can be integrated into the PC network and conveniently controlled via a user interface in the web browser using a laptop or smartphone – even over the Internet while you're on the go.

Building control system interfaces and optional controls and air quality sensors provide additional options. The clever, modular design of the appliances allows for custom configurations according to the property requirements.

The new KWL EC "S" range

for standing, space-saving floor installations is available with ventilation system performances of 800 to 2600 m³/h. Ideal for use as central systems with heat recovery in residential, commercial and industrial applications.

Certified according to the passive house standard and including special control technology for constant volume regulation or constant pressure regulation. Optionally with built-in PWW heat register.

Helios KWL® added value

The universal, perfectly coordinated Helios KWL® systems solutions guarantee simple planning, secure assembly and maximum efficiency.

Services such as KWL® specialist seminars and practical workshops and the almost self-explanatory online software tool KWLeasyPlan.de further simplify the design, planning and installation of the systems.

Ask for more information now!

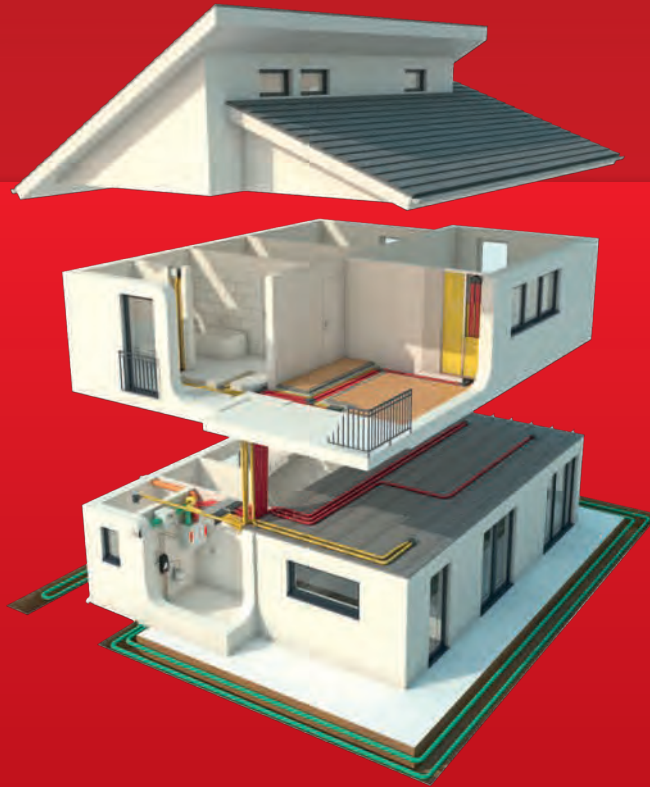

SELECTION MATRIX

i 78

ENTHALPY EXCHANGER

i 84

EASY CONTROLS

i 85

WALL INSTLLATION,
WALL MOUNTING "W"



KWL EC 45, KWL EC 60 for flush wall mounting in single rooms, ideal for renovations.

The "W" range

Compact wall units from 200 to 500 m³/h. KWL EC 270, 370 W with passive house certificates. All models are equipped with easyControls as standard and optional enthalpy exchanger.

80^{on}

CEILING MOUNTING "D"



The "D" range

Ultra-thin units from 220 to 2000 m³/h for space-saving ceiling installation.

With ultra-efficient heat exchanger, EC technology and passive house certificate. KWL EC 220, 340 D with easyControls as standard.

96^{on}

STAND MOUNTING "S"



The "S" range

With units ventilation system performances from 800 to 2600 m³/h for standing floor installation. Ideal as central systems in residential, commercial and industrial applications.

With ultra-efficient heat exchanger, EC technology and passive house certificate.

106^{on}























PERIPHERY



Ideally coordinated additional appliances such as geothermal heat exchangers and active humidification system HygroBox to enhance the functions of the KWL® system as a whole. Innovative air distribution systems for all installation types and areas of application. Designer ventilation valves and much more.

114^{on}



		Typical applications					Maximum energy efficiency class*			
		Living space	Single family house	Apartment building - apartment central	Multi-family house - building central	Commerce / municipal buildings				
Ventilation units	Wall installation / Wall mounting		KWL EC 45	•					A	
			KWL EC 60	•					B	
			KWL EC 200 W		•	•				A
			KWL EC 200 W ET		•	•				A
			KWL EC 270 W		•	•				A+
			KWL EC 270 W ET		•	•				A
			KWL EC 300 W		•	•				A
			KWL EC 300 W ET		•	•				A
			KWL EC 370 W		•	•				A
			KWL EC 370 W ET		•	•				A
			KWL EC 500 W		•	•		•		A
			KWL EC 500 W ET		•	•		•		A
Ventilation units	Ceiling mounting		KWL EC 220 D		•	•			A+	
			KWL EC 340 D		•	•			A+	
			KWL EC 700 D				•	•		
			KWL EC 1400 D				•	•		
			KWL EC 2000 D				•	•		
Ventilation units	Floor mounting		KWL EC 800 S				•	•		
			KWL EC 1200 S				•	•		
			KWL EC 1800 S				•	•		
			KWL EC 2600 S				•	•		
Periphery		HygroBox		•	•					
		Ground heat exchang.		•	•					
		IsoPipe®		•	•					
		RenoPipe			•					
		FlexPipe®plus		•	•	•				
		Flat duct		•						

* See KWL® unit product pages for details.

Application (Rated ventilation) / Maximum ventilation in m³/h		Humidity recovery	Passive house certificate	Page
	50			80
	100			82
	150			86
	200			86
	250			88
	300			88
	350			90
	400			90
	500			92
	750			92
	1000			94
	1250			94
	1500			96
	1750			98
	2000			100
	2500			102
				104
				106
				108
				110
				112
				116
				118
				122
				126
				128
				133

KWL® with heat recovery



KWL EC 45 from Helios:
Decentralized apartment ventilation with heat recovery in switchover mode. 5 ventilation levels in 3 operating modes, ideal for new construction and renovation.

Easily installed – with minimal installation effort in a few simple steps.

Easily configured thanks to unique setup software. Also in combination with extract air systems – an all-round success!

KWL EC 45 belongs to the category of regenerative switchover ventilation units with heat recovery.

It is designed for installation in the building outer wall. The air passage takes place on the outside wall via a fascia from high-grade steel.

On the wall inside a closable fascia made from high quality polymers is used, in which a fibre fleece air filter of the class G3 and a sound insulation are integrated.

The KWL EC 45 has an EC axial fan, which is operated periodically in reverse mode. In this way, supply air phases alternate with extract air phases continuously.

The regenerative heat exchange is carried out using of a ceramic heat accumulator. This takes up heat from the interior air (storage charging) during the extract air mode to transfer it in the next supply air mode to the incoming fresh air (storage discharging). Efficiency up to 85 % (according to the current DIBt test method). To protect it from dirt a fly-screen is fixed on the outside of the ceramic heat accumulator.

To ensure a balanced ventilation operation, a minimum of 2 units is required for an apartment, which in its operational phase (supply air/ extract air) work phase-shifted. Depending on the total air demand of the apartment more than 2 units are usually installed, whose individual flow rates are adjusted with the controller automatically on each other.

■ Highlights KWL EC 45

- Economical and silent EC-axial fan.
- Elegant and timeless design.
- Tool-free, easy assembly and dismantling of components.
- Integrated sound insulation.
- Integrated G3 air filter, easily accessible and replaceable without tools.
- Simple, intuitive operation via two buttons.
- LED display for current operating mode and fan speed.
- Up to 8 ventilation units can be controlled.
- 5 ventilation levels:
14, 24, 32, 37, 45 m³/h.
- 3 operating modes:
Heat recovery (= Reversing mode), cross ventilation and supply air mode.
- Possibilities of external activation of standby, cross ventilation, supply air or boost mode (highest ventilation level) by using an external contact.
- Intelligent integration of e.g. demand-controlled extract air fans like Helios ELS or M1 via an extension module (accessory).
- Filter change indicator.
- Programming via PC.

■ Control

The controller enables the control of up to 8 ventilation units. At the controller 5 ventilation levels and 3 operating modes can be adjusted:
Heat recovery (= Reversing mode), cross ventilation and supply air mode.
After a preset time period the user is reminded of the filter change by flashing LEDs on the controller.

■ GUI – Graphic User Interface

With the Helios software it is possible to connect the controller via the USB interface with a PC or laptop. This way the settings of the control can be easily and comfortably accessed.

- The implementation of the start-up procedure and the input of required values (such as filter change interval or minimum fan speed) can thus be made in the shortest possible time. All provided settings can be changed fast with the program interface and be supported by the respectively suitable help texts user-friendly.

- The configurations made can be stored directly on the PC or laptop and loaded or copied when required into the control system. In a larger object the installation costs can be reduced to a minimum.

If several identical ventilation systems are installed, the required configuration will be established once for a ventilation system and can then be transferred to any number of controllers.



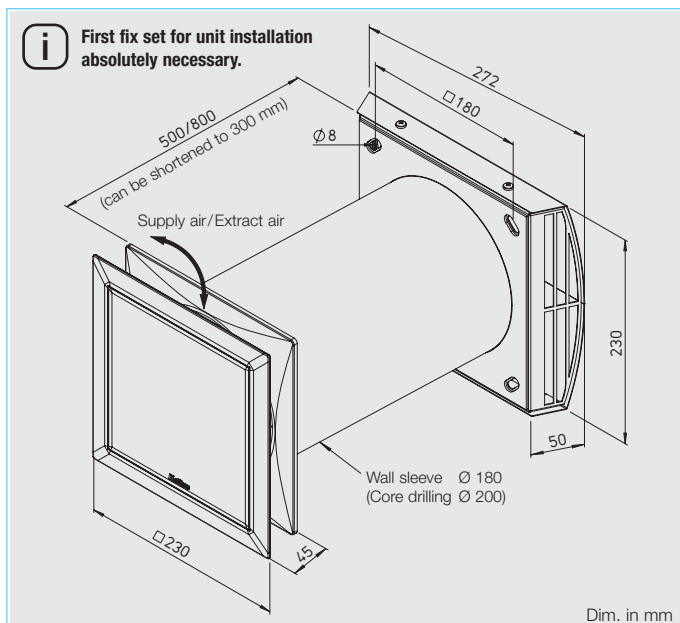

Accessories

Switching power supply UP

To extend the controller set KWL 45 STS-UP to up to 8 ventilation units.

Input 230 V AC, 50/60 Hz.
Output 12 V DC / 1,9 A for flush mounting in insulated walls.
Output voltage to SELV protection class 3.

According to DIN EN 60335-1.
Type KWL 45 SNU No. 3008

Switching power supply HS

To extend the controller set KWL 45 STS-HS to up to 8 ventilation units.

Input 230 V AC, 50/60 Hz.
Output 12 V DC / 1,5 A for installation in the distribution box (2 TE).
Output voltage to SELV protection class 3.

According to DIN EN 60335-1.
Type KWL 45 SNH No. 3001

Extension module

For the combined operation of an extract air system, e.g. Helios ELS or M1 with KWL EC 45 (hybrid ventilation).

Type KWL 45 EM No. 3012

Casing for surface-mounting

For the included controller in the control set KWL 45 STS-UP.
Dimensions mm (W x H x D)
83 x 83 x 41

Type KWL-APG No. 4270

Room sensor

Electromechanical humidity controller for connection to the external contact of the control unit. Adjustable function using Helios software or control unit. Attention: Parallel use with KWL-EM is not possible.

For surface installation dim. mm (W x H x D) 76 x 76 x 34

Type HY 3 No. 1359

with internal scale
Type HY 3 SI No. 1360

Ordering and delivery

Coordinated with the assembly steps the following elements are packed separately and have to be ordered individually:

First fix set facade (500 mm)

Robust wall sleeve made of plastic material, including plaster protective cover for indoor and outdoor. External fascia from high-grade steel. Additional aids for the mounting of the wall sleeve with incline included in delivery.

KWL 45 RSF No. 3005
with additional coating

for use in environments with severe air pollution or high salt concentrations in the air (near the coast).

KWL 45 RSF-B No. 1963

First fix set facade (800 mm)

KWL 45 RSF-L No. 3070
with additional coating

KWL 45 RSF-LB No. 1955

Ventilation unit

Consisting of design inner panel with filter, ceramic heat exchanger, flow straighteners, fly screen, EC axial fan with guard, pull-out tool (cord) and EPP half shell heat insulation elements.

KWL EC 45 No. 3011

Control set UP

Consisting of controller KWL 45 BEU and switching power supply KWL 45 SNU for installation in flush-mounted socket (depth 61 mm).

Allows the connection of up to 6 ventilation units.

With more than 6 ventilation units an additional 45 KWL SNU is required.

Max. 8 ventilation units possible per controller.

According to DIN EN 60335-1.
KWL 45 STS-UP No. 3006

Control set HS

Consisting of controller KWL 45 BEU and switching power supply KWL 45 SNH for DIN rails (2 TE).

Allows the connection of up to 4 ventilation units.

With more than 4 ventilation units an additional KWL 45 SNH is required.

Max. 8 ventilation units possible per controller.

According to DIN EN 60335-1
KWL 45 STS-HS No. 3007

Replacement air filter

- 2 pcs. G3 filter
ELF-KWL 45/3/3 No. 3069

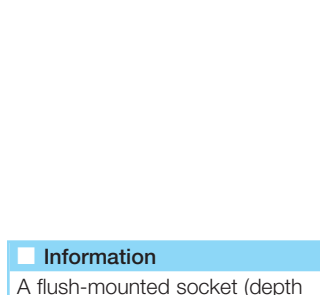
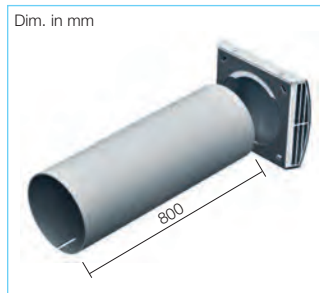

Information

A flush-mounted socket (depth 61 mm) is required for the controller KWL 45 BEU and for each installed switching power supply KWL 45 SNU.

Technical data					
Ventilation unit ¹⁾	KWL EC 45 ¹⁾ Ref. no. 3011				
Air flow volume on speed step	5	4	3	2	1
Supply/Extract air V m ³ /h	45	37	32	24	14
Sound pressure L _{PA} dB(A)	34	29	27	21	14
Sound insulation D _{n,e,w} dB	44				
Power consumption W	4,5	3,4	2,8	2,1	1,6
Heat recovery efficiency ²⁾	up to 88 %				
Operating voltage power supply	Input 230 V~, 50/60 Hz / Output 12 V=				
Nominal current mA	42	32	27	21	17
El. lead power supply unit ³⁾	NYM-O 2 x 1,5 mm ²				
El. lead supply control ³⁾	NYM-O 2 x 1,5 mm ²				
El. lead to fan ⁴⁾	J-Y (ST) Y 3 x 0,8 mm				
Wiring diagram no.	1091 / 1093				
Weight approx. kg	4,3				

¹⁾ The first fix set required for this (types KWL 45 RSF) must be ordered separately (see above for details).

²⁾ According to latest DIBt-test methods. ³⁾ Use of NYM-J 3 x 1,5 mm² permitted.

⁴⁾ Use of J-Y (ST) Y 2 x 2 x 0,8 mm permitted.

Compact wall unit with heat recovery for ventilation of single rooms.

KWL EC 60 is the proven solution for comfortable indoor climate and energy saving in single rooms.

Ideal to bring existing buildings up to modern standards in the course of a renovation and to EnEV standard.

KWL EC 60 supplies small and larger single rooms.

For a medium-sized flat the installation of several units is recommended.

Installed in no time – ideal for renovation

KWL EC 60 is the optimal renovation solution, also for additional installation. The access to the outside air is simply made by a core drilling in the outer wall in which the wall sleeve is inserted.

This can be done simply during the facade renovation. Two protection cover plates close the openings. The installation of the elegantly designed external fascia which is made from high grade-steel takes place with the final plastering works. During the interior work the



Elegant external fascia made of high-grade steel.

unit is inserted into the wall sleeve and connected electrically. Only the elegant fascia is seen inside the room. Therefore the KWL EC 60 blends in everywhere beautifully and the fascia shields the view of the fan interior completely.

Aluminium plate heat exchanger with efficiency of more than 70 %
Expensive heating energy is saved with KWL EC 60 and its efficient large heat transfer area aluminium plate heat exchanger with efficiency of more than 70 %.

ECgreenVent® by Helios

Efficient energy-saving ventilation units with EC-technology including the Helios KWL EC 60 are given the ECgreenVent® label. KWL EC 60 allows the demand ventilation with heat recovery of individual rooms; several units can be controlled independently. Regulating is not necessary.

Operating mode of the KWL EC 60 ventilation with heat recovery

Two highly efficient fans with energy-saving EC-motors move the supply and extract air. Smells and stale room air are extracted outside, fresh and preheated air is supplied into the room. The heat of the extracted air is recovered by the large heat transfer area aluminium plate heat exchanger and transferred through the plates to the incoming fresh external air, so both air flows remain separated.

* External components such as external fascias, spacer frames and guards are made of high-grade steel. Alternatively available in coated version (Type -B) for use in environments with high levels of air pollution or high salt concentrations in the air (near coast).

KWL EC 60

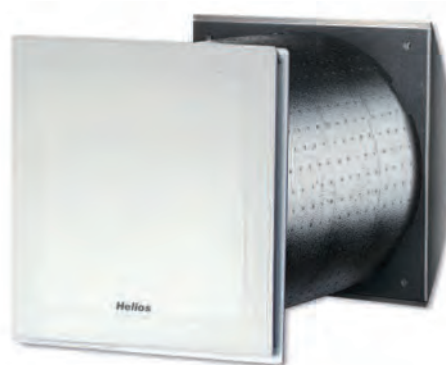

Efficiency class

- B** KWL EC 60 Pro with additional room sensor
KWL EC 60 Pro FF
- D** KWL EC 60 Eco / Pro



Delivery / Ordering

Coordinated with the assembly steps the following elements are packed separately and have to be ordered individually:

- First fix set**, consisting of wall sleeve (length 349 mm), two protection cover plates and external fascia made from high-grade steel (Type RS-B with additional coating*).

Type KWL 60 RS No. 0708
Type KWL 60 RS-B No. 1961

- Ventilation unit, in Eco or Pro.**

Similarities

Heat exchanger

- Large heat transfer area aluminium plate heat exchanger with efficiency of more than 70 %.

Fans

Two highly efficient fans with energy-saving EC-motors move the supply and extract air with minimum power consumption.

Condensation spigot

Condensation is led directly to the outside via the ext. fascia.

Air filter

- Two efficient air filters of class G4 in the supply and extract air stream guarantee the best air purity. A pollen filter (class F7) is available for the supply air as an accessory.

KWL EC 60 Eco

The energy saving solution with favourable price/performance ratio for all applications.

- Ventilation unit Eco**, consisting of indoor fascia from high quality polymer with integrated 3-speed controller.

Type KWL EC 60 Eco No. 9950

Speed control

Three-speed operation via controller, integrated in the indoor fascia (can be positioned alternatively on top or bottom by 180° turn of fascia). Disconnection via on/off switch on site.

Electrical connection

Via plug-in connector.

Technical data

Ventilation unit ¹⁾	KWL EC 60 Eco ¹⁾	Ref. no. 9950	
Air flow volume on step²⁾ Supply/extract V m ³ /h	60	30	17
Sound level dB(A) Case breakout L _{pA} in 3 m	30	22	18
Fan power 2xW	4	2	1
Sound insulation D _{n,e} dB(A)	39-41		
Voltage/Frequency	230 V~, 50 Hz		
Nominal current A	0.05		
Protection to IP	X4		
Electric supply	NYM-J 3 x 1.5 mm ²		
Wiring diagram no.	949		
Temperature operating range	- 20 °C to + 40 °C		
Weight approx. kg	6.5		

¹⁾ The necessary first fix set (Type KWL 60 RS) is to be ordered additionally (see details above).

²⁾ Volume reduction by approx. 10 % when using the F7 filter.

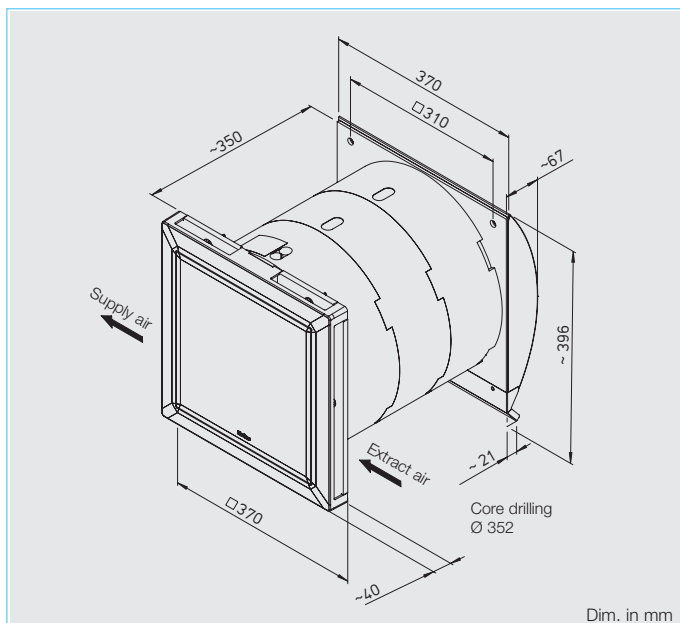

KWL EC 60 Pro / Pro FF
Fulfills even highest demands in comfort, with many useful functions.

□ **Ventilation unit Pro**, consisting of indoor facia from high quality polymer and comfort controller (KWL-BCU, 1 pc incl. in delivery). See details on the right.
Type KWL EC 60 Pro No. 9951

□ **Ventilation unit Pro FF**, KWL EC 60 Pro, however with additional integrated humidity sensor for ventilation as needed. Adjustable humidity level.
KWL EC 60 Pro FF No. 9957

■ **Power control**
The comfort controller with graphic display and user-friendly menu navigation (included in delivery) makes the following functions possible:
– Four-speed manual operation or with digital timer.
– Control via intelligent CO₂- and humidity sensors (accessories, in each case up to 4 controllers can be installed).

- Supply/extract air operation separately adjustable.
- Boost ventilation, intensive ventilation.
- Display of required filter change, operating state, operating hours, error messages.
- Several units can be controlled with one comfort controller.
- Several comfort controllers can be connected to one unit.

■ **Shutters**
Two shutters seal airtight to the outside when the unit is off (holiday or downtimes), one shutter seals individually with supply or extract air operation.

■ **Electrical connection**
Via plug-in connector (incl. in delivery).

Technical data				
Ventilation unit¹⁾ – incl. humidity sensor	KWL EC 60 Pro¹⁾	Ref. no. 9951		
	KWL EC 60 Pro FF¹⁾	Ref. no. 9957		
Air flow volume on step²⁾ Supply/ Extract V m ³ /h	4	3	2	1
	60	45	30	17
Sound level dB(A) Case breakout L _{PA} in 3 m	30	29	22	18
Fan power 2xW	4	3	2	1
Sound insulation D _{n,e} dB(A)	39-41			
Voltage/Frequency	230 V~, 50 Hz			
Nominal current A	0.06			
Protection class IP	X4			
Electric supply	NYM-J 3 x 1.5 mm ²			
Wiring diagram no.	950			
Temperature operating range	– 20 °C to + 40 °C			
Weight approx. kg	6.5			

¹⁾ The necessary first fix set (KWL 60 RS, Ref.-No. 0708) is to be ordered additionally (see details above).

■ **Delivery / Ordering**
Coordinated with the assembly steps the following elements are packed separately and have to be ordered individually:

□ **First fix set**,
as described on the left page.
Type KWL 60 RS No. 0708
Type KWL 60 RS-B No. 1961

□ **Ventilation unit, in Eco or Pro.**

■ **Similar accessories**
Extension sleeve
For wall thickness 349 to 571 mm. Length 111 mm can be shortened to any length with partition element.
Type KWL 60 WV No. 0884

Sound insulation set
Consisting of sound insulation frame and mat, white, 100 mm depth. Sound reduction up to 6 dB.
Type KWL 60 SDS No. 3059

Spacer frame
from high grade steel for outside wall, length 100 mm, with partition element. For wall thickness from 249 to 349 mm.
Type KWL 60 DR No. 0888
Type KWL 60 DR-B No. 1962

Guard
from high grade steel (2 pieces), for installation to outside facia.
Type KWL 60 SG No. 9978
Type KWL 60 SG-B No. 9976

■ **Accessories for KWL EC 60 Pro Comfort controller (addit.)**
Display and function as described on the left. One piece KWL-BCU included in delivery. Up to 4 controllers can be connected. 3 m connecting cable included in delivery. Dim. mm (WxHxD) for flush mounting up 80x80x37

KWL-BCU (flush) No. 9955
Dim. mm (WxHxD) 83x83x51

KWL-BCA (surface) No. 9956

Casing for surface installation
Dim. mm (WxHxD) 83x83x41
KWL-APG No. 4270

Room sensor
Measures CO₂ concentration and transfers data to the ventilation unit to arrange for an optimal CO₂ level in all 4 speeds. 3 m connecting cable included in delivery. Up to 4 sensors can be plugged in. In this case, the sensor with the highest measurement is used for setting the unit.
Dim. mm (WxHxD) 95 x 97 x 30
KWL EC-CO₂ No. 9988

Connecting cable
For distances > 3 m, with 2 RJ 12 plugs. For connection between controller and KWL EC 60 Pro and / or between several ventilation units.
KWL-SL 6/5 (5 m) No. 9980
KWL-SL 6/10 (10 m) No. 9444
KWL-SL 6/20 (20 m) No. 9959

i Basic installation kit is absolutely necessary.

■ **Replacement air filters**
– 2 pcs. G4 filter
ELF-KWL 60/4/4 No. 9445
– 2 pcs. F7 filter
ELF-KWL 60/7/7²⁾ No. 9446

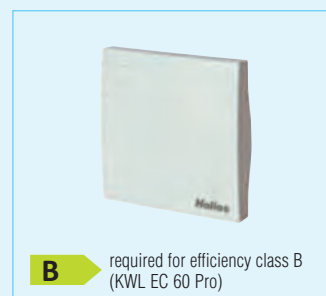
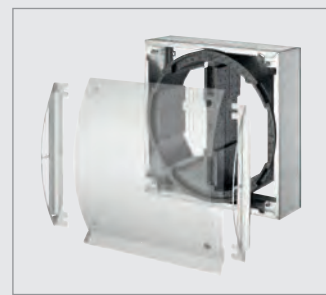

B required for efficiency class B (KWL EC 60 Pro)

Wye junction board
To connect further units or controllers and accessory components which are not included in delivery (each 1 piece required).
Type KWL-ALA No. 9960

²⁾ Allow a volume reduction of about 10 % when using a F7 filter



Heat and humidity recovery for a comfortable climate.

KWL® units with combined heat and humidity recovery by enthalpy exchanger provide for a comfortable, healthy room climate, without additional energy consumption and without use of an atmospheric humidifier.

Ideal room climate provides a healthy environment.

In living quarters the relative room humidity should lie between 35–60%. With too low humidity mucous membranes, dry dust and electrostatic charges increase.

These effects become apparent in the cold season. During this period, the absolute moisture content in the outside air is much less in comparison to summer.

If the used air with a high absolute humidity content is replaced by fresh but dry air with a smaller absolute humidity content, the humidity in the room will decrease noticeably.

Ventilation units with enthalpy heat exchanger recover, in addition to the heat, up to 70% of humidity from the extract air. This is used to warm the outside air, which flows into the living and reception rooms with a comfortable, healthy moisture content.

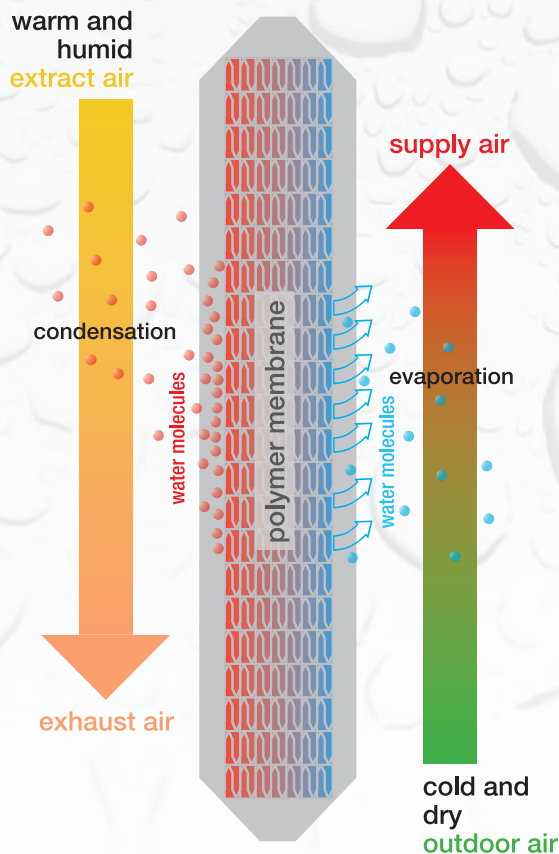

Operating mode of enthalpy heat exchanger:

The water molecules of the extracted room air condense on contact with surfaces of the enthalpy heat exchanger. They move the water in a similar way to plants, through the membrane. At the membrane surface of the supply airside the water molecules are absorbed by dry outside air.

The polymer membrane of the enthalpy heat exchanger guarantees hygiene and efficiency with the humidity transmission process.

It ensures the water retains its molecular configuration to enter the supply air flow. Extract and supply air flows are hermetically separated from each other, so that an overall transfer of organic particles or odours is excluded.

Ventilation units with enthalpy heat exchanger offer convincing advantages:

- Twofold benefit through energy-saving heat recovery and hygienic humidity recovery in the cold season.
- Humidity recovery from the extract air up to 70%, depending on the interior air humidity.
- Additional humidifiers are unnecessary.

KWL® control concept Helios easyControls

Helios easyControls revolutionises with integrated web server and LAN connection the ease of use of KWL® units. The models equipped with easyControls as standard (see product pages) can be easily and fast integrated into the PC network and operated via the convenient interface in any web browser. Whether with PC or laptop, tablet or smart phone. At any time, in any room.

■ Highlights

- Web browser operation whether from home or on the road, in the home network or via the Internet, from any terminals.
- Including building control interface (integrated Modbus, KNX optional.)

■ Options

- Automatic, demand responsive operation using CO₂-, mixed gas- (VOC) or humidity sensor.
- Manual operation via comfort controller with graphic display or step switch.

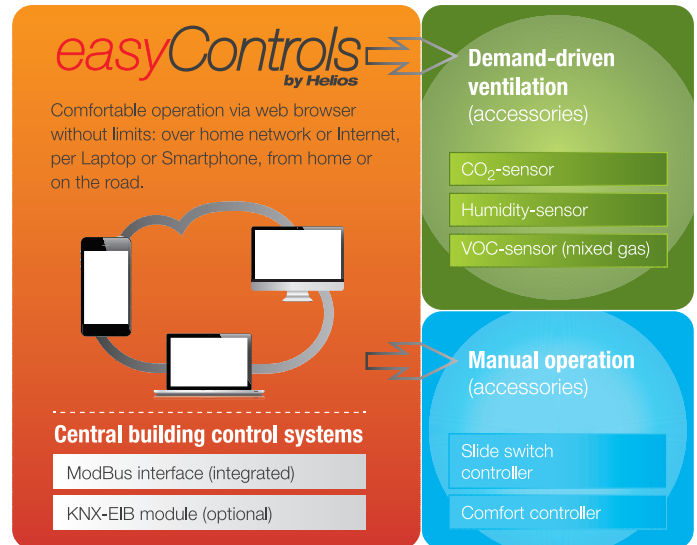

KWL® with heat recovery

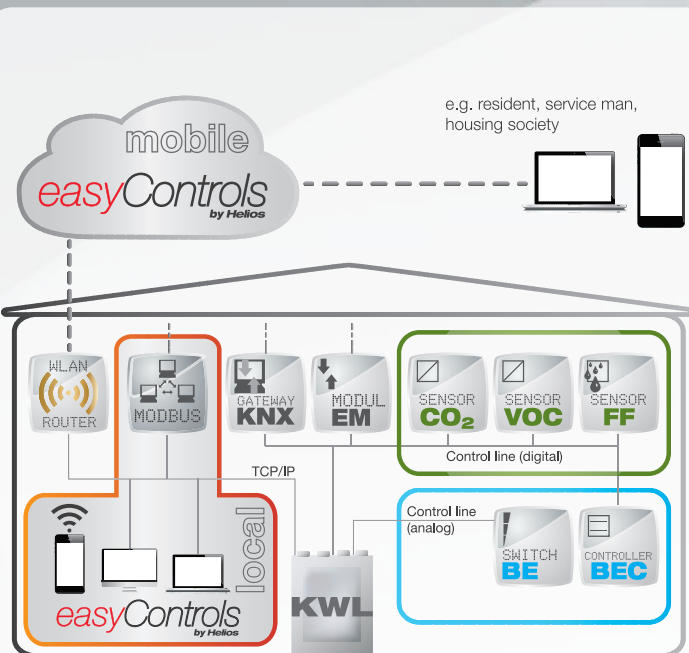

■ Basic functions of the local Helios easyControls web server

- Start-up assistant
- Selection / setting of speed step
- Setting of clock timer Ventilation / Heating
- Activation of intensive- / whisper- / vacation mode
- Selection of access rights
- Locking controllers
- Setting of CO₂-, VOC- and humidity control
- Software-Updates (via Internet)
- Display of filter change, Operating conditions / hours, error messages etc.

■ Additional features of the Helios easyControls web portal (on the road via the Internet)

- Password-protected access to the KWL® ventilation system (e.g. via Smartphone or laptop)
- Graphic temperature analysis
- Remote maintenance (housing society or craftsman)
- Storage of the last three configurations
- Error message per e-Mail
- Error history
- Support by Helios service via Remote Access Control

■ Location-independent access

EasyControls provides direct access on the KWL® unit regardless of where you are. Whether from home or on the road via the Internet, active connection presumed. Authorised users, service engineers or housing societies can comfortably change unit settings or query status information via the Helios easyControls web portal at any time.

■ Central building control systems

The KWL® unit simply can be integrated into a network of the central building control system over the standard Modbus interface (TCP/IP) or an optionally available KNX module.

■ Simply configured and quickly taken into operation

During the operation the advantages of the comfortable interface for the system configuration and start-up are demonstrated.

Even without a PC network: simply connect the KWL® unit via LAN cable to the laptop and open the menu of easyControls in the browser.

■ Always up-to-date

With Helios easyControls the ventilation unit updates itself simply and quickly over the Internet with the latest software.

■ Demand-driven and energy-saving

Using easyControls and optionally connected CO₂-, mixing gas-(VOC) or humidity sensor the KWL® unit provides automatically for an optimum living space climate and extracts the air pollution which originate, e.g., while cooking or showering reliably. This saves energy.

■ Manual operation

If no PC network available or is a manual access preferred, easyControls can be controlled via a comfort control with graphic display or a step switch.



KWL EC 200 W

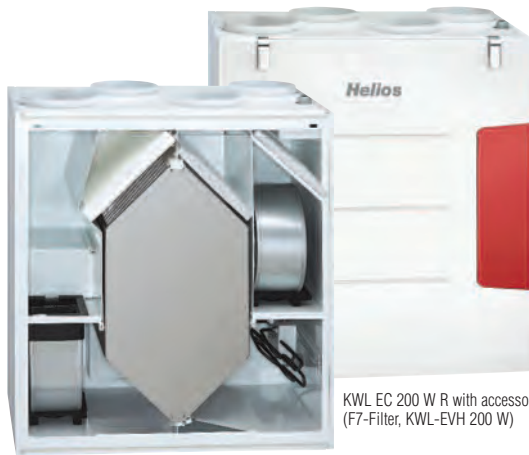

KWL EC 200 W R with accessory (F7-Filter, KWL-EVH 200 W)

Efficiency class

A

KWL EC 200 W R/L and 200 W ET R/L



KWL EC 200 W R

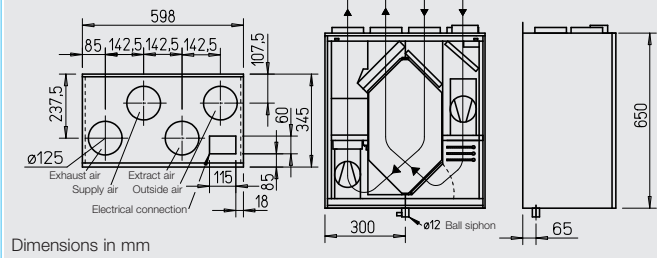

Dimensions in mm

KWL EC 200 W L

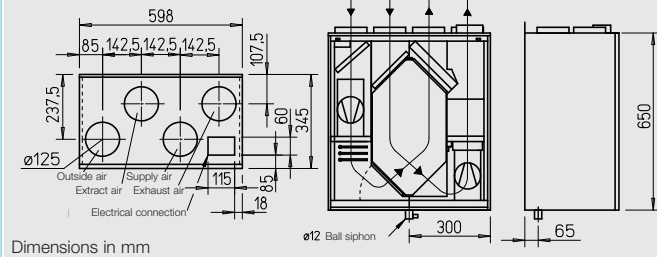

Dimensions in mm

Compact unit with heat recovery for central ventilation of houses and apartments. Equipped with Helios easyControls, the innovative control concept for easiest network connection and web browser operation. Optionally with highly efficient polymer-enthalpy heat exchangers for additional humidity recovery. With energy-saving EC-motors.

Casing

Made from galvanised steel, white powder coated, double walled, heat and noise insulated (12 mm) on all sides. Easy to install and maintain. The removable front panel allows full access.

Heat exchanger

- Due to its large surface area the exchanger provides an exceptionally high efficiency of up to 90 %.
- Types "ET" are equipped with highly efficient enthalpy exchangers for additional humidity recovery.

Fans

Two silent and energy saving centrifugal fans with energy saving EC-motors move the supply air and extract air. They are maintenance free and easy to remove for cleaning.

Ducting

Crossover-free connection of intake-, exhaust-, extract- and supply air ducts with NW 125 mm by means of spigots for connection (RVBD 125 K, accessories).

Condensation outlet

The condensation outlet is located at the bottom of the unit. Ball siphon included in delivery.

To be connected to drain pipe by installer.

Air filter

Supply of cleaned outside air using a G4 filter. Additionally a F7 pollen filter is available. Extract air passes through a G4 filter before entering the heat exchanger.

Summer operation

Comes with automatic bypass function and exchanger cover plate as standard.

Frost protection of heat exchanger

The standard frost monitoring automatically regulates the supply air flow and the optional built-in electric pre-heater battery (KWL-EVH 200 W, accessories).

Helios easyControls

The standard equipment with Helios easyControls allows the simple LAN integration of the KWL-unit into a PC network. The ventilation unit is operated comfortably via the Helios easyControls menu in the web browser, by PC/laptop in the LAN or by Tablet/Smartphone in the WLAN – whether in the home network or on the road via Internet. Functionality, see page 85.

- EasyControls is prepared for:
 - Manual control elements (KWL-BE, -BEC, accessories).
 - Air quality sensors for automatic, demand-driven ventilation (KWL-CO₂, -FTF, -VOC, accessories).
 - Connection to central building control systems via integrated Modbus interface or optional KNX module (KWL-KNX, accessories).

Electrical connection

Fixed connection via a power cord 3 x 1.5 mm², approx. 2 m long with wire end ferrules. Control line for control elements, sensors, ModBus and LAN to be plugged in on the outside of the unit.

Accessories – functional description (details on right)

KWL EC 200 W is individually expandable with the following accessories:

Slide switch controller

- Three speed operation via slide switch.
- Three freely definable operating levels within the entire family of performance curves.
- Via the offset function, the extract fan can be operated with ± 20 % difference.
- Control voltage directly at the controller measurable.
- For the realisation of a further operation level, such as night mode, expandable option with clock timer (WSUP/WSUP-S, No. 9990/9577, accessories).
- Light-emitting diode for optical display of the operating conditions, such as filter change, supply air temperature < +5 °C, errors and operation.

Comfort controller

- Comfort controller with graphic display and user-friendly menu navigation:
 - Start-up assistant.
 - Selection of speed level (auto/manual, level 1-4).
 - Four freely definable operating levels within the entire family of performance curves.
 - Setting of weekly program Ventilation/Heating.
 - Setting of CO₂-, VOC- and humidity parameter.
 - Display of e.g. filter change,

operating conditions, hours of operation and error messages.

- Lock function.

KNX/EIB module

Allows the coupling of the ventilation unit with the central building control system via KNX/EIB.

Room sensor

For the automatic operation and optimal air exchange are sensors available which measure the mixed gas, CO₂-concentration and the relative humidity.

Extension module

For the connection of accessories, such as shutters, under-soil heat exchangers for pre-heating of the outdoor air or a heater battery (optional water- or electric heater battery with maximum 2.6 kW, 230 V, 50 Hz).

Heater battery

Helios easyControls can regulate via an extension module (KWL-EM, accessories) performance-related an electric (EHR with KWL-LTK, accessories) or water heater battery (WHR with WHSH and KWL-LTK, accessories). Temperature profiles are adjustable in the weekly program. Furthermore is a self-sufficient operation of the water heater battery via an air temperature control system (WHST 300 T38, accessories) possible, regardless of Helios easyControls.

Notes

Helios easyControls The innovative KWL® control concept	Page 85
Humidity recovery by enthalpy heat exchanger	Page 84

KWL EC 200 W

Frequency	Hz	total	125	250	500	1k	2k	4k	8k
L _{WA} Extract air	dB(A)	45	36	33	32	37	30	25	17
L _{WA} Supply air	dB(A)	45	36	33	32	37	30	25	17
L _{PA} Case breakout	dB(A)	43	37	37	38	40	36	28	19

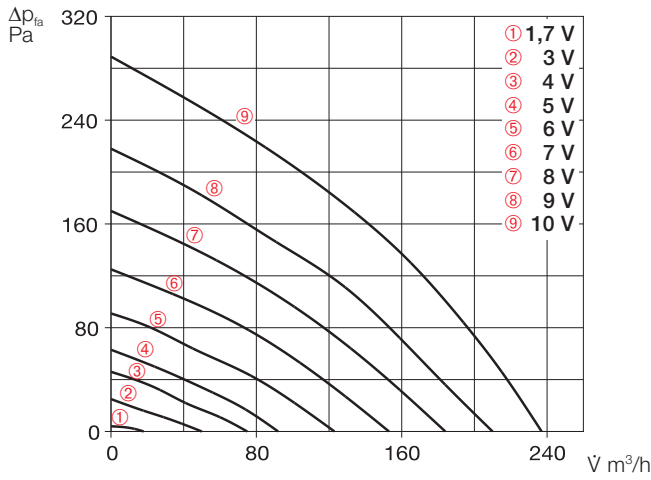

Slide switch controller

Three speed slide switch incl. operation display, for flush installation. Function see on the left. Control line SL 6/3 (length = 3 m) included in delivery, other lengths (SL 6/..., accessories) available for order.

Dim. mm (W x H x D) 80 x 80 x 37
Type KWL-BE Ref. no. 4265

Casing for surface installation

Dim. mm (W x H x D) 83 x 83 x 41
Type KWL-APG Ref. no. 4270



Comfort controller

With graphic display, for flush installation. Function see on the left. Up to 8 pcs. can be installed. Control line SL 4/3 (length = 3 m) included in delivery, other lengths (SL 4/..., accessories) available for order.

Dim. mm (W x H x D) 80 x 80 x 37
Type KWL-BEC Ref. no. 4263

Casing for surface installation

Dim. mm (W x H x D) 83 x 83 x 41
Type KWL-APG Ref. no. 4270



KNX/EIB module

Allows the connection of the ventilation unit to a KNX/EIB central building control system. For switchboard installation (1 space unit required).

Type KWL-KNX Ref. no. 4275

Adapter board

Adapter from ribbon cable to wires or cables. For connection of KNX module and RJ10 control line.

Type KWL-RJ10 KL No. 4277



Room sensor

Measures CO₂, mixed gas- (VOC) concentration or relative humidity. Max. of 8 sensors each can be connected, control according to respective highest measured value. Incl. control line SL 4/3 (length = 3 m), other lengths (SL 4/..., accessories) available for order.

Dim. mm (W x H x D) 95 x 97 x 30

Type KWL-CO₂ Ref. no. 4272
Type KWL-FTF Ref. no. 4273
Type KWL-VOC Ref. no. 4274

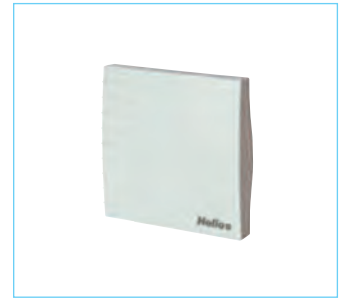

Electric pre-heater battery

Electric pre-heating for simple, plug-in device installation. Allows the pre-heating of the intake air at very low outside temperatures (heat exchanger frost protection). Mandatory for passive houses. Power: 1000 W.

KWL-EVH 200 W Ref. no. 4224



Extension module

For controlling external shutters, undersoil heat exchangers and/or heater batteries. Incl. temperature sensor KWL-LTK and control line KWL-SL 4/3.

Dim. mm (WxHxD) 210x210x100

Type KWL-EM Ref. no. 4269



Electric heater battery

For additional supply air heating.

EHR-R 1,2/125 Ref. no. 9433

Duct temperature sensor

KWL-LTK (1 pc. required.) No. 9644



Water heater battery

For additional supply air heating.

Type WHR 125 Ref. no. 9480

Duct temperature sensor

KWL-LTK (2 pcs. required.) No. 9644

Hydraulic unit

WHS HE 24 V (0-10 V) No. 8318

Alternative:

Air temperature control

WHST 300 T38 Ref. no. 8817

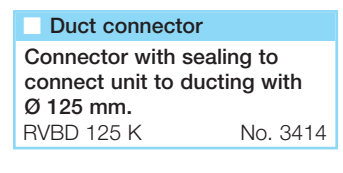

Duct connector

Connector with sealing to connect unit to ducting with Ø 125 mm.

RVBD 125 K No. 3414

Technical data	With polymer heat exchanger					With enthalpy heat exchanger				
	Type	Ref. no.	Type	Ref. no.	Type	Ref. no.	Type	Ref. no.	Type	Ref. no.
Right-hand version	KWL EC 200 W R	4220	KWL EC 200 W ET R	4221						
Left-hand version	KWL EC 200 W L	4222	KWL EC 200 W ET L	4223						
Air flow volume on step¹⁾²⁾ Supply/extract air flow vol. V m ³ /h	9	7	5	3	1	9	7	5	3	1
	235	180	120	75	20	235	180	120	75	20
Sound levels dB(A)³⁾										
Supply air L _{WA} (sound power level)	45	40	34	29	28	45	40	34	29	28
Extract air L _{WA} (sound power level)	45	40	33	29	28	45	40	33	29	28
Case breakout L _{PA} in 1 m	43	38	30	< 25	< 25	43	38	30	< 25	< 25
Fan power 2xW¹⁾	49	26	15	9	6	49	26	15	9	6
Standby power consumption	< 1 W									
Voltage/Frequency	1 ~ 230 V, 50 Hz									
Nom. cur. A	-									
- ventilation	1.0									
- pre-heater	4.4									
- max. total	1.0 (5.4 incl. pre-heater, accessories)									
Electric pre-heater kW	1.0 kW (accessories)									
Summer Bypass	automatic (adjustable), with exchanger cover									
Wiring Diagram no.	1042									
Temperature operation range	-20 °C to +40 °C									
Set-up temp.	+5 °C to +40 °C									
Weight approx. kg	41									

¹⁾ At 0 Pa, speed steps adjustable at will. ²⁾ Allow a volume reduction of about 10 % when using a F7 filter.
³⁾ At 100 Pa, sound levels raise with increasing system pressure.

KWL EC 270 W



Efficiency class

- A+** KWL EC 270 W R/L with additional room sensor
- A** KWL EC 270 W R/L and 270 W ET R/L



KWL EC 270 W R

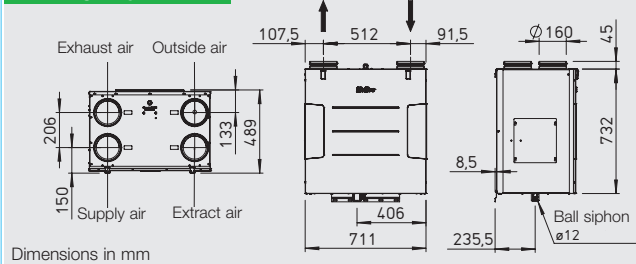

KWL EC 270 W L

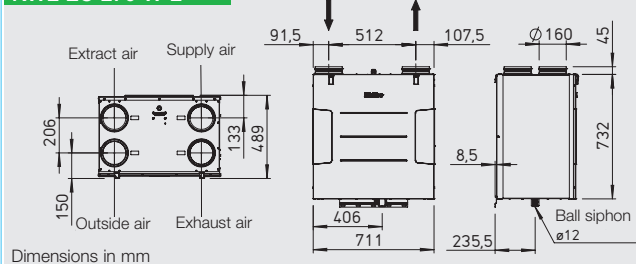

Compact unit with heat recovery for central ventilation of houses and apartments. Certified according to passive-house standards. Equipped with Helios easyControls, the innovative control concept for easiest network connection and web browser operation. Optional with highly efficient polymer- or enthalpy heat exchanger for additional humidity recovery. Energy-saving EC motor with constant air flow regulation.

■ Casing

Made from galvanised sheet steel, white powder coated. Interior from high quality expanded polystyrene (EPS) for maximum heat insulation. Easy to install and maintain. The removable front panel allows full access.

■ Heat exchanger

■ Condensation outlet

■ Summer operation

See description on page 86.

■ Fans

Two silent highly efficient centrifugal fans with energy-saving EC motors and constant flow rate regulation move the supply air and extract air continuously also on change of the pressure in the system. They are maintenance free and easily accessible through the front.

■ Ducting

Crossover-free connection of intake-, exhaust-, extract- and supply air ducts with NW 160. Spigots with sealing lips for connection located on top of the unit.

■ Air filter

Supply of cleaned outside air using a G4 filter. Superfine pollen filter F7 (always necessary for passive-houses) is also available. Extract air passes through a G4 filter before entering the heat exchanger. A G4 bypass filter is included as standard, optional F7.

■ Frost protection of heat exchanger

The standard frost monitoring automatically regulates the supply air flow and the external pre-heater battery (EHR-R 1,2/160, accessories). It is controlled by the extension module (KWL-EM, accessories). An air filter is to be pre-connected to the pre-heater battery in G4 execution (accessories).

■ Helios easyControls

The standard equipment with Helios easyControls allows the simple LAN integration of the KWL-unit into a PC network. The ventilation unit is operated comfortably via the Helios easyControls menu in the web browser, by PC/laptop in the LAN or by Tablet/Smartphone in the WLAN – whether in the home network or on the road via Internet. Functionality, see page 85. EasyControls is prepared for:

- Manual control elements (KWL-BE, -BEC, accessories).
- Air quality sensors for automatic, demand-driven ventilation (KWL-CO₂, -FTF, -VOC, accessories).
- Connection to central building control systems via integrated Modbus interface or optional KNX module (KWL-KNX, accessories).

■ Electrical connection

Fixed connection via a power cord 3 x 1.5 mm², approx. 2 m long with wire end ferrules. Control line for control elements, sensors, ModBus and LAN to be plugged in on the outside of the unit.

■ Accessories – functional description (details on right)

KWL EC 270 W is individually expandable with the following accessories:

□ Slide switch controller

- Three speed operation via slide switch.
- Three freely definable operating levels within the entire family of performance curves.
- Via the offset function, the extract fan can be operated with ± 20 % difference.
- Control voltage directly at the controller measurable.
- For the realisation of a further operation level, such as night mode, expandable option with clock timer (WSUP/WSUP-S, No. 9990/9577, accessories).
- Light-emitting diode for optical display of the operating conditions, such as filter change, supply air temperature < +5 °C, errors and operation.

□ Comfort controller

- Comfort controller with graphic display and user-friendly menu navigation:
- Start-up assistant.
- Selection of speed level (auto/manual, level 1-4).
- Four freely definable operating levels within the entire family of performance curves.
- Setting of weekly program Ventilation/Heating.
- Setting of CO₂-, VOC- and humidity parameter.
- Display of e.g. filter change,

operating conditions, hours of operation and error messages.

- Lock function.

□ KNX/EIB module

Allows the coupling of the ventilation unit with the central building control system via KNX/EIB.

□ Room sensor

For the automatic operation and optimal air exchange are sensors available which measure the mixed gas, CO₂-concentration and the relative humidity.

□ Extension module

For the connection of accessories, such as shutters, under-soil heat exchangers for pre-heating of the outdoor air or a heater battery (optional water- or electric heater battery with maximum 2.6 kW, 230 V, 50 Hz).

□ Heater battery

Helios easyControls can regulate via an extension module (KWL-EM, accessories) performance-related an electric (EHR with KWL-LTK, accessories) or water heater battery (WHR with WHSH and KWL-LTK, accessories). Temperature profiles are adjustable in the weekly program. Furthermore is a self-sufficient operation of the water heater battery via an air temperature control system (WHST 300 T38, accessories) possible, regardless of Helios easyControls.

■ Notes

Helios easyControls The innovative KWL® control concept	Page 85
Humidity recovery by enthalpy heat exchanger	Page 84

KWL EC 270 W

Frequency*	Hz	Total	125	250	500	1k	2k	4k	8k
L _{WA} Extract air		dB(A) 49	29	43	46	36	38	33	22
L _{WA} Supply air		dB(A) 63	49	56	59	57	54	48	41
L _{PA} Case breakout		dB(A) 43	30	35	41	36	33	29	25

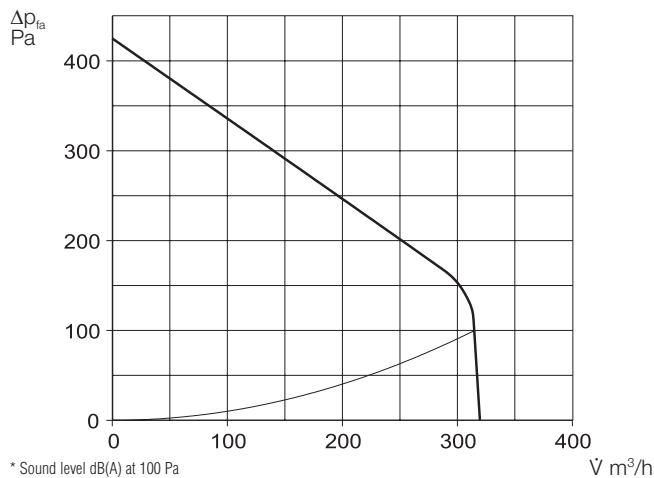

Slide switch controller

Three speed slide switch incl. operation display, for flush installation. Function see on the left. Control line SL 6/3 (length = 3 m) included in delivery, other lengths (SL 6/..., accessories) available for order.

Dim. mm (W x H x D) 80 x 80 x 37
Type KWL-BE Ref. no. 4265

Casing for surface installation

Dim. mm (W x H x D) 83 x 83 x 41
Type KWL-APG Ref. no. 4270



Comfort controller

With graphic display, for flush installation. Function see on the left. Up to 8 pcs. can be installed. Control line SL 4/3 (length = 3 m) included in delivery, other lengths (SL 4/..., accessories) available for order.

Dim. mm (W x H x D) 80 x 80 x 37
Type KWL-BEC Ref. no. 4263

Casing for surface installation

Dim. mm (W x H x D) 83 x 83 x 41
Type KWL-APG Ref. no. 4270



Technical data	With polymer heat exchanger			With enthalpy heat exchanger		
	Type	Ref. no.	Type	Ref. no.	Type	Ref. no.
Right-hand version	KWL EC 270 W R	4228	KWL EC 270 W ET R	4229		
Left-hand version	KWL EC 270 W L	4230	KWL EC 270 W ET L	4231		
Air flow volume on step¹⁾	③	②	①	③	②	①
Supply/extract air flow vol. V. m ³ /h	285	170	110	285	170	110
Sound levels dB(A)²⁾						
Supply air L _{WA} (sound power level)	63	52	46	63	52	46
Extract air L _{WA} (sound power level)	49	38	32	49	38	32
Case breakout L _{PA} in 1 m	43	32	27	43	32	27
Fan power 2xW ¹⁾	68	19	10	68	19	10
Standby power consumption	< 1 W					
Voltage/Frequency	1 - 230 V, 50 Hz					
Nom. cur. A - ventilation	1.0					
Summer Bypass	automatic (adjustable)					
Wiring Diagram no.	1044					
Temperature operation range	-20 °C to +40 °C					
Set-up temp.	+5 °C to +40 °C					
Weight approx. kg	49					

¹⁾ At 0 Pa, speed steps adjustable at will.

²⁾ At 100 Pa, sound levels raise with increasing system pressure.

KNX/EIB module

Allows the connection of the ventilation unit to a KNX/EIB central building control system. For switchboard installation (1 space unit required).

Type KWL-KNX Ref. no. 4275



Adapter board

Adapter from ribbon cable to wires or cables. For connection of KNX module and RJ10 control line.

Type KWL-RJ10 KL No. 4277

Room sensor

Measures CO₂, mixed gas- (VOC) concentration or relative humidity. Max. of 8 sensors each can be connected, control according to respective highest measured value. Incl. control line SL 4/3 (length = 3 m), other lengths (SL 4/..., accessories) available for order.

Dim. mm (W x H x D) 95 x 97 x 30

Type KWL-CO₂ Ref. no. 4272

Type KWL-FTF Ref. no. 4273

Type KWL-VOC Ref. no. 4274



A+ required for efficiency class A+ (KWL EC 270 W R/L)

Electric pre-heater battery

Allows the pre-heating of the intake air at very low outside temperatures (heat exchanger frost protection). Mandatory for passive houses. Power: 1200 W. Controllable via extension module (KWL-EM, see below). G4-filter is to pre-connected (LFBR 160 G4).

EHR-R 1,2/160 Ref. no. 9434

LFBR 160 G4 Ref. no. 8578



Extension module

For controlling external shutters, undersoil heat exchangers and/or heater batteries. Incl. temperature sensor KWL-LTK and control line KWL-SL 4/3.

Dim. mm (WxHxD) 210x210x100

Type KWL-EM Ref. no. 4269



Electric heater battery

For additional supply air heating.

EHR-R 2,4/160 Ref. no. 9435

Duct temperature sensor

KWL-LTK (1 pc. required) No. 9644

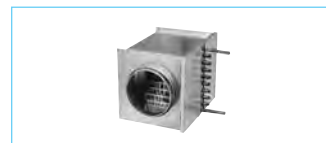

Water heater battery

For additional supply air heating.

Type WHR 160 Ref. no. 9481

Duct temperature sensor

KWL-LTK (2 pcs. required.)No. 9644

Hydraulic unit

WHSR HE 24V(0-10V) No. 8318

Alternative: **Air temp. control**

WHST 300 T38 Ref. no. 8817

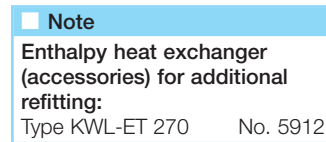

Note

Enthalpy heat exchanger (accessories) for additional refitting:

Type KWL-ET 270 No. 5912

Replacement air filter

- 2 pcs. G4-Filter

ELF-KWL 270/4/4 No. 9613

- 1 pc. F7-Filter

ELF-KWL 270/7 No. 9614

- 2 pcs. G4-Filter for Bypass

ELF-KWL 270/4/4 BP No. 9617

- 1 pc. F7-Filter for Bypass

ELF-KWL 270/7 BP No. 9618

Other accessories Page

KWL® periphery	114 on
- Undersoil heat exch.	118 on
- Insulated duct system	122 on
- Air distribution systems	126 on
- Control lines, a.o.	136 on
Heater battery, -control	426 on
grilles, ducting,	
roof terminations,	487 on
Extract air elements,	
Design valves	500 on

KWL EC 300 W



KWL EC 300 W R with accessory (F7-Filter, KWL-EVH 300 W)

Efficiency class

A

KWL EC 300 W R/L and 300 W ET R/L



KWL EC 300 W R

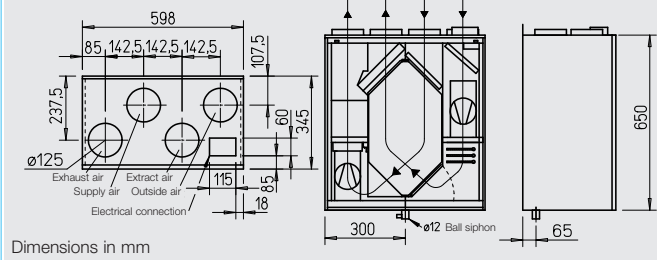

Dimensions in mm

KWL EC 300 W L

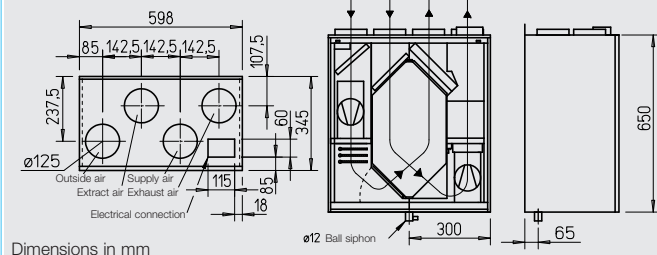

Dimensions in mm

Compact unit with heat recovery for central ventilation of houses and apartments. Equipped with Helios easyControls, the innovative control concept for easiest network connection and web browser operation. Optionally with highly efficient polymer-enthalpy heat exchangers for additional humidity recovery. With energy-saving EC-motors.

■ Casing

Made from galvanised steel, white powder coated, double walled, heat and noise insulated (12 mm) on all sides. Easy to install and maintain. The removable front panel allows full accessible.

■ Heat exchanger

- Due to its large surface area the exchanger provides an exceptionally high efficiency of up to 90 %.
- Types "ET" are equipped with highly efficient enthalpy exchangers for additional humidity recovery.

■ Fans

Two silent and energy saving centrifugal fans with energy saving EC-motors move the supply air and extract air. They are maintenance free and easy to remove for cleaning.

■ Ducting

Crossover-free connection of intake-, exhaust-, extract- and supply air ducts with NW 125 mm by means of spigots for connection (RVBD 125 K, accessories).

■ Condensation outlet

The condensation outlet is located at the bottom of the unit. Ball siphon included in delivery.

To be connected to drain pipe by installer.

■ Air filter

Supply of cleaned outside air using a G4 filter. Additionally a F7 pollen filter is available. Extract air passes through a G4 filter before entering the heat exchanger.

■ Summer operation

Comes with automatic bypass function and exchanger cover plate as standard.

■ Frost protection of heat exchanger

The standard frost monitoring automatically regulates the supply air flow and the optional built-in electric pre-heater battery (KWL-EVH 300 W, accessories).

■ Helios easyControls

The standard equipment with Helios easyControls allows the simple LAN integration of the KWL-unit into a PC network. The ventilation unit is operated comfortably via the Helios easyControls menu in the web browser, by PC/laptop in the LAN or by Tablet/Smartphone in the WLAN – whether in the home network or on the road via Internet. Functionality, see page 85.

- EasyControls is prepared for:
 - Manual control elements (KWL-BE, -BEC, accessories).
 - Air quality sensors for automatic, demand-driven ventilation (KWL-CO₂, -FTF, -VOC, accessories).
 - Connection to central building control systems via integrated Modbus interface or optional KNX module (KWL-KNX, accessories).

■ Electrical connection

Fixed connection via a power cord 3 x 1.5 mm², approx. 2 m long with wire end ferrules. Control line for control elements, sensors, ModBus and LAN to be plugged in on the outside of the unit.

■ Accessories – functional description (details on right)

KWL EC 300 W is individually expandable with the following accessories:

Slide switch controller

- Three speed operation via slide switch.
- Three freely definable operating levels within the entire family of performance curves.
- Via the offset function, the extract fan can be operated with ± 20 % difference.
- Control voltage directly at the controller measurable.
- For the realisation of a further operation level, such as night mode, expandable option with clock timer (WSUP/WSUP-S, No. 9990/9577, accessories).
- Light-emitting diode for optical display of the operating conditions, such as filter change, supply air temperature < +5 °C, errors and operation.

Comfort controller

- Comfort controller with graphic display and user-friendly menu navigation:
 - Start-up assistant.
 - Selection of speed level (auto/manual, level 1-4).
 - Four freely definable operating levels within the entire family of performance curves.
 - Setting of weekly program Ventilation/Heating.
 - Setting of CO₂-, VOC- and humidity parameter.
 - Display of e.g. filter change,

operating conditions, hours of operation and error messages.

- Lock function.

KNX/EIB module

Allows the coupling of the ventilation unit with the central building control system via KNX/EIB.

Room sensor

For the automatic operation and optimal air exchange are sensors available which measure the mixed gas, CO₂-concentration and the relative humidity.

Extension module

For the connection of accessories, such as shutters, under-soil heat exchangers for pre-heating of the outdoor air or a heater battery (optional water- or electric heater battery with maximum 2.6 kW, 230 V, 50 Hz).

Heater battery

Helios easyControls can regulate via an extension module (KWL-EM, accessories) performance-related an electric (EHR with KWL-LTK, accessories) or water heater battery (WHR with WHSH and KWL-LTK, accessories). Temperature profiles are adjustable in the weekly program. Furthermore is a self-sufficient operation of the water heater battery via an air temperature control system (WHST 300 T38, accessories) possible, regardless of Helios easyControls.

■ Notes

Helios easyControls The innovative KWL® control concept	Page 85
Humidity recovery by enthalpy heat exchanger	Page 84

KWL EC 300 W

Frequency	Hz	Total	125	250	500	1k	2k	4k	8k	
L _{WA}	Extract air	dB(A)	51	43	40	42	38	37	30	20
L _{WA}	Supply air	dB(A)	45	44	41	41	37	37	29	18
L _{PA}	Case breakout	dB(A)	45	40	40	42	42	41	34	24

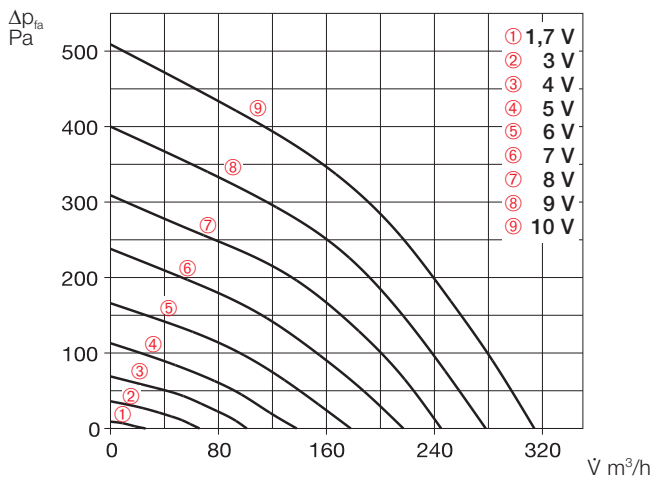

Slide switch controller

Three speed slide switch incl. operation display, for flush installation. Function see on the left. Control line SL 6/3 (length = 3 m) included in delivery, other lengths (SL 6/..., accessories) available for order.

Dim. mm (W x H x D) 80 x 80 x 37
Type KWL-BE Ref. no. 4265

Casing for surface installation

Dim. mm (W x H x D) 83 x 83 x 41
Type KWL-APG Ref. no. 4270



Comfort controller

With graphic display, for flush installation. Function see on the left. Up to 8 pcs. can be installed. Control line SL 4/3 (length = 3 m) included in delivery, other lengths (SL 4/..., accessories) available for order.

Dim. mm (W x H x D) 80 x 80 x 37
Type KWL-BEC Ref. no. 4263

Casing for surface installation

Dim. mm (W x H x D) 83 x 83 x 41
Type KWL-APG Ref. no. 4270



Technical data	With polymer heat exchanger					With enthalpy heat exchanger				
	Type	Ref. no.				Type	Ref. no.			
Right-hand version	KWL EC 300 W R	4232				KWL EC 300 W ET R	4233			
Left-hand version	KWL EC 300 W L	4234				KWL EC 300 W ET L	4235			
Air flow volume on step^{1) 2)}	9	7	5	3	1	9	7	5	3	1
Supply/extract air flow vol. V m³/h	315	240	180	100	26	315	240	180	100	26
Sound levels dB(A)³⁾										
Supply air L _{WA} (sound power level)	51	46	39	32	27	51	46	39	32	27
Extract air L _{WA} (sound power level)	51	46	39	32	26	51	46	39	32	26
Case breakout L _{PA} in 1 m	45	41	34	28	<25	45	41	34	28	<25
Fan power 2xW ¹⁾	100	57	28	12	6	100	57	28	12	6
Standby power consumption	< 1 W									
Voltage/Frequency	1 ~ 230 V, 50 Hz									
Nom. cur. A	- ventilation 1.3									
	- pre-heater 4.4									
	- max. total 1.3 (5.7 incl. pre-heater, accessories)									
Electric pre-heater kW	1.0 kW (accessories)									
Summer Bypass	automatic (adjustable), with exchanger cover									
Wiring Diagram no.	1042									
Temperature operation range	-20 °C to +40 °C									
Set-up temp.	+5 °C to +40 °C									
Weight approx. kg	42									

¹⁾ At 0 Pa, speed steps adjustable at will.

²⁾ Allow a volume reduction of about 10 % when using a F7 filter.

³⁾ At 100 Pa, sound levels raise with increasing system pressure.

KNX/EIB module

Allows the connection of the ventilation unit to a KNX/EIB central building control system. For switchboard installation (1 space unit required).

Type KWL-KNX Ref. no. 4275



Adapter board

Adapter from ribbon cable to wires or cables. For connection of KNX module and RJ10 control line.

Type KWL-RJ10 KL No. 4277

Room sensor

Measures CO₂, mixed gas- (VOC) concentration or relative humidity. Max. of 8 sensors each can be connected, control according to respective highest measured value. Incl. control line SL 4/3 (length = 3 m), other lengths (SL 4/..., accessories) available for order.

Dim. mm (W x H x D) 95 x 97 x 30

Type KWL-CO₂ Ref. no. 4272

Type KWL-FTF Ref. no. 4273

Type KWL-VOC Ref. no. 4274



Electric pre-heater battery

Electric pre-heating for simple, plug-in device installation. Allows the pre-heating of the intake air at very low outside temperatures (heat exchanger frost protection). Mandatory for passive houses. Power: 1000 W.

KWL-EVH 300 W Ref. no. 4224



Extension module

For controlling external shutters, undersoil heat exchangers and/or heater batteries. Incl. temperature sensor KWL-LTK and control line KWL-SL 4/3.

Dim. mm (WxHxD) 210x210x100

Type KWL-EM Ref. no. 4269



Electric heater battery

For additional supply air heating.

EHR-R 1,2/125 Ref. no. 9433

Duct temperature sensor

KWL-LTK (1 pc. required.) No. 9644



Water heater battery

For additional supply air heating.

Type WHR 125 Ref. no. 9480

Duct temperature sensor

KWL-LTK (2 pcs. required.) No. 9644

Hydraulic unit

WHSW HE 24 V(0-10V) No. 8318

Alternative:

Air temperature control

WHST 300 T38 Ref. no. 8817

Replacement air filter

- 2 pcs. G4-Filter

ELF-KWL 300/4/4 No. 0021

- 1 pc. F7-Filter

ELF-KWL 300/7²⁾ No. 0038

- 2 pcs. G4-Filter, 1 pc. F7-Filter

ELF-KWL 300/4/4/7 No. 0020

Note

Enthalpy heat exchanger (accessories) for additional refitting:

Type KWL-ET 300 No. 0896

Duct connector

Connector with sealing to connect unit to ducting with Ø 125 mm.

RVBD 125 K No. 3414

Other accessories Page

KWL® periphery	114 on
- Undersoil heat exch.	118 on
- Insulated duct system	122 on
- Air distribution systems	126 on
- Control lines, a.o.	136 on
Heater battery, -control grilles, ducting, roof terminations,	426 on
Extract air elements,	487 on
Design valves	500 on

KWL EC 370 W



Efficiency class

A

KWL EC 370 W R/L and 370 W ET R/L



KWL EC 370 W R

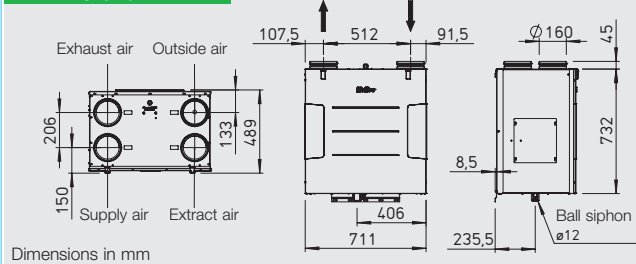

KWL EC 370 W L

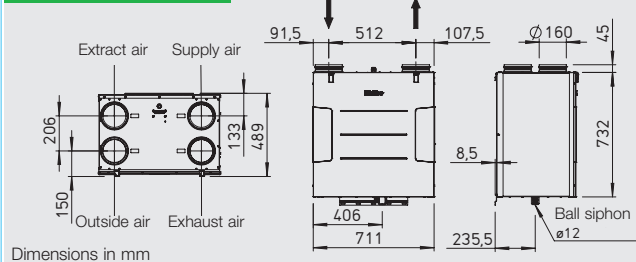

Compact unit with heat recovery for central ventilation of houses and apartments. Certified according to passive-house standards. Equipped with Helios easyControls, the innovative control concept for easiest network connection and web browser operation. Optional with highly efficient polymer- or enthalpy heat exchanger for additional humidity recovery. Energy-saving EC motor with constant air flow regulation.

■ Casing

Made from galvanised sheet steel, white powder coated. Interior from high quality expanded polystyrene (EPS) for maximum heat insulation. Easy to install and maintain. The removable front panel allows full accessible.

■ Heat exchanger

■ Condensation outlet

■ Summer operation

See description on page 86.

■ Fans

Two silent highly efficient centrifugal fans with energy-saving EC motors and constant flow rate regulation move the supply air and extract air continuously also on change of the pressure in the system. They are maintenance free and easily accessible through the front.

■ Ducting

Crossover-free connection of intake-, exhaust-, extract- and supply air ducts with NW 160. Spigots with sealing lips for connection located on top of the unit.

■ Air filter

Supply of cleaned outside air using a G4 filter. Superfine pollen filter F7 (always necessary for passive-houses) is also available. Extract air passes through a G4 filter before entering the heat exchanger. A G4 bypass filter is included as standard, optional F7.

■ Frost protection of heat exchanger

The standard frost monitoring automatically regulates the supply air flow and the external pre-heater battery (EHR-R 1,2/160, accessories). It is controlled by the extension module (KWL-EM, accessories). An air filter is to be pre-connected to the pre-heater battery in G4 execution (accessories).

■ Helios easyControls

The standard equipment with Helios easyControls allows the simple LAN integration of the KWL-unit into a PC network. The ventilation unit is operated comfortably via the Helios easyControls menu in the web browser, by PC/laptop in the LAN or by Tablet/Smartphone in the WLAN – whether in the home network or on the road via Internet. Functionality, see page 85.

EasyControls is prepared for:

- Manual control elements (KWL-BE, -BEC, accessories).
- Air quality sensors for automatic, demand-driven ventilation (KWL-CO₂, -FTF, -VOC, accessories).
- Connection to central building control systems via integrated Modbus interface or optional KNX module (KWL-KNX, accessories).

■ Electrical connection

Fixed connection via a power cord 3 x 1.5 mm², approx. 2 m long with wire end ferrules. Control line for control elements, sensors, ModBus and LAN to be plugged in on the outside of the unit.

■ Accessories – functional description (details on right)

KWL EC 370 W is individually expandable with the following accessories:

□ Slide switch controller

- Three speed operation via slide switch.
- Three freely definable operating levels within the entire family of performance curves.
- Via the offset function, the extract fan can be operated with ± 20 % difference.
- Control voltage directly at the controller measurable.
- For the realisation of a further operation level, such as night mode, expandable option with clock timer (WSUP/WSUP-S, No. 9990/9577, accessories).
- Light-emitting diode for optical display of the operating conditions, such as filter change, supply air temperature < +5 °C, errors and operation.

□ Comfort controller

- Comfort controller with graphic display and user-friendly menu navigation:
- Start-up assistant.
- Selection of speed level (auto/manual, level 1-4).
- Four freely definable operating levels within the entire family of performance curves.
- Setting of weekly program Ventilation/Heating.
- Setting of CO₂-, VOC- and humidity parameter.
- Display of e.g. filter change,

operating conditions, hours of operation and error messages.

- Lock function.

□ KNX/EIB module

Allows the coupling of the ventilation unit with the central building control system via KNX/EIB.

□ Room sensor

For the automatic operation and optimal air exchange are sensors available which measure the mixed gas, CO₂-concentration and the relative humidity.

□ Extension module

For the connection of accessories, such as shutters, under-soil heat exchangers for pre-heating of the outdoor air or a heater battery (optional water- or electric heater battery with maximum 2.6 kW, 230 V, 50 Hz).

□ Heater battery

Helios easyControls can regulate via an extension module (KWL-EM, accessories) performance-related an electric (EHR with KWL-LTK, accessories) or water heater battery (WHR with WHSH and KWL-LTK, accessories). Temperature profiles are adjustable in the weekly program. Furthermore is a self-sufficient operation of the water heater battery via an air temperature control system (WHST 300 T38, accessories) possible, regardless of Helios easyControls.

■ Notes

Helios easyControls The innovative KWL® control concept	Page 85
Humidity recovery by enthalpy heat exchanger	Page 84

KWL EC 370 W

Frequency*	Hz	total	125	250	500	1k	2k	4k	8k
L _{WA} Extract air		dB(A) 56	41	53	52	38	40	33	23
L _{WA} Supply air		dB(A) 70	60	64	66	63	64	59	53
L _{PA} Case breakout		dB(A) 51	43	44	44	44	43	39	34

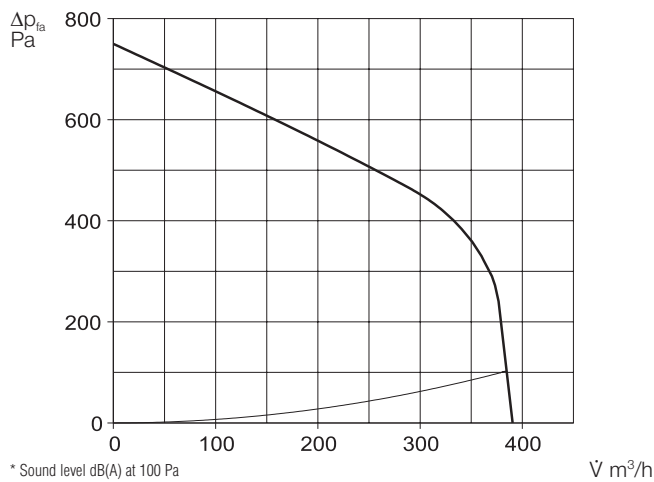

Slide switch controller

Three speed slide switch incl. operation display, for flush installation. Function see on the left. Control line SL 6/3 (length = 3 m) included in delivery, other lengths (SL 6/..., accessories) available for order.

Dim. mm (W x H x D) 80 x 80 x 37
Type KWL-BE Ref. no. 4265

Casing for surface installation

Dim. mm (W x H x D) 83 x 83 x 41
Type KWL-APG Ref. no. 4270



Comfort controller

With graphic display, for flush installation. Function see on the left. Up to 8 pcs. can be installed. Control line SL 4/3 (length = 3 m) included in delivery, other lengths (SL 4/..., accessories) available for order.

Dim. mm (W x H x D) 80 x 80 x 37
Type KWL-BEC Ref. no. 4263

Casing for surface installation

Dim. mm (W x H x D) 83 x 83 x 41
Type KWL-APG Ref. no. 4270



Technical data	With polymer heat exchanger			With enthalpy heat exchanger		
	Type	Ref. no.	Type	Ref. no.	Type	Ref. no.
Right-hand version	KWL EC 370 W R	4245	KWL EC 370 W ET R	4246		
Left-hand version	KWL EC 370 W L	4247	KWL EC 370 W ET L	4248		
Air flow volume on step¹⁾	3	2	1	3	2	1
Supply/extract air flow vol. \dot{V} m ³ /h	350	200	140	350	200	140
Sound levels dB(A)²⁾						
Supply air L _{WA} (sound power level)	71	58	52	71	58	52
Extract air L _{WA} (sound power level)	56	44	37	56	44	37
Case breakout L _{PA} in 1 m	51	41	34	51	41	34
Fan power 2xW ¹⁾	111	25	14	111	25	14
Standby power consumption	< 1 W					
Voltage/Frequency	1 - 230 V, 50 Hz					
Nom. cur. A - ventilation	2.2					
Summer Bypass	automatic (adjustable)					
Wiring Diagram no.	1044					
Temperature operation range	-20 °C to +40 °C					
Set-up temp.	+5 °C to +40 °C					
Weight approx. kg	52					

¹⁾ At 0 Pa, speed steps adjustable at will.

²⁾ At 100 Pa, sound levels raise with increasing system pressure.

KNX/EIB module

Allows the connection of the ventilation unit to a KNX/EIB central building control system. For switchboard installation (1 space unit required).

Type KWL-KNX Ref. no. 4275

Adapter board

Adapter from ribbon cable to wires or cables. For connection of KNX module and RJ10 control line.

Type KWL-RJ10 KL No. 4277

Room sensor

Measures CO₂, mixed gas- (VOC) concentration or relative humidity. Max. of 8 sensors each can be connected, control according to respective highest measured value. Incl. control line SL 4/3 (length = 3 m), other lengths (SL 4/..., accessories) available for order.

Dim. mm (W x H x D) 95 x 97 x 30

Type KWL-CO₂ Ref. no. 4272

Type KWL-FTF Ref. no. 4273

Type KWL-VOC Ref. no. 4274



Electric pre-heater battery

Allows the pre-heating of the intake air at very low outside temperatures (heat exchanger frost protection). Mandatory for passive houses. Power: 1200 W. Controllable via extension module (KWL-EM, see below). G4-filter is to pre-connected (LFBR 160 G4).

EHR-R 1,2/160 Ref. no. 9434

LFBR 160 G4 Ref. no. 8578



Extension module

For controlling external shutters, undersoil heat exchangers and/or heater batteries. Incl. temperature sensor KWL-LTK and control line KWL-SL 4/3.

Dim. mm (WxHxD) 210x210x100

Type KWL-EM Ref. no. 4269



Electric heater battery

For additional supply air heating

EHR-R 2,4/160 Ref. no. 9435

Duct temperature sensor

KWL-LTK (1 pc. required.) No. 9644

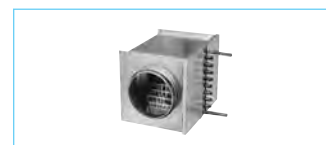

Water heater battery

For additional supply air heating.

Type WHR 160 Ref. no. 9481

Duct temperature sensor

KWL-LTK (2 pcs. required.) No. 9644

Hydraulic unit

WHSR HE 24 V (0-10 V) No. 8318

Alternative: **Air temp. control**

WHST 300 T38 Ref. no. 8817

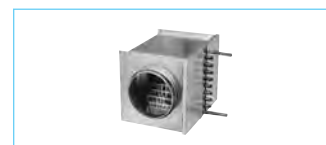

Other accessories Page

KWL® periphery	114 on
- Undersoil heat exch.	118 on
- Insulated duct system	122 on
- Air distribution systems	126 on
- Control lines, a.o.	136 on
Heater battery, -control	426 on
grilles, ducting,	
roof terminations,	487 on
Extract air elements,	
Design valves	500 on

Note

Enthalpy heat exchanger (accessories) for additional refitting:

Type KWL-ET 370 No. 5912

Replacement air filter

- 2 pcs. G4-Filter	
ELF-KWL 370/4/4	No. 9613
- 1 pc. F7-Filter	
ELF-KWL 370/7	No. 9614
- 2 pcs. G4-Filter for Bypass	
ELF-KWL 370/4/4 BP	No. 9617
- 1 pc. F7-Filter for Bypass	
ELF-KWL 370/7 BP	No. 9618

KWL EC 500 W



Efficiency class

A

KWL EC 500 W R/L and 500 W ET R/L



KWL EC 500 W R

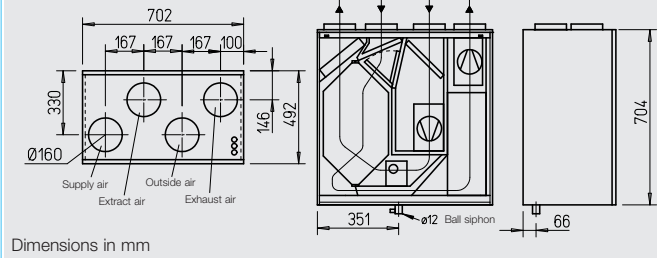

KWL EC 500 W L

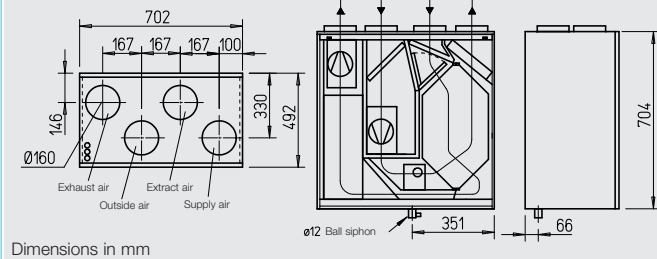

Compact unit with heat recovery for central ventilation of houses and apartments. Equipped with Helios easyControls, the innovative control concept for easiest network connection and web browser operation. Optionally with highly efficient polymer- or enthalpy heat exchangers for additional humidity recovery. With energy-saving EC-motors. Generally approved by DIBt, Z-51.3-226.

■ Casing

Made from galvanised steel, white powder coated, double walled, heat and noise insulated (12 mm) on all sides. Easy to install and maintain. The removable front panel allows full access.

■ Heat exchanger

- Due to its large surface area the exchanger provides an exceptionally high efficiency of up to 90 %.
- Types "ET" are equipped with highly efficient enthalpy exchangers for additional humidity recovery.

■ Fans

Two silent and energy-saving centrifugal fans with energy saving EC-motors move the supply air and extract air. They are maintenance free and easy to remove for cleaning.

■ Ducting

Crossover-free connection of intake-, exhaust-, extract- and supply air ducts with NW 160 mm by means of spigots for connection (RVBD 160 K, accessories).

■ Condensation outlet

The condensation outlet is located at the bottom of the unit.

Ball siphon included in delivery. To be connected to drain pipe by installer.

■ Air filter

Supply of cleaned outside air using a G4 filter. Additionally a F7 pollen filter is available. Extract air passes through a G4 filter before entering the heat exchanger.

■ Summer operation

Comes with automatic bypass function and exchanger cover plate as standard.

■ Frost protection of heat exchanger

The standard frost monitoring automatically regulates the supply air flow and the optional built-in electric pre-heater battery (KWL-EVH 500 W, accessories).

■ Helios easyControls

The standard equipment with Helios easyControls allows the simple LAN integration of the KWL-unit into a PC network. The ventilation unit is operated comfortably via the Helios easyControls menu in the web browser, by PC/laptop in the LAN or by Tablet/Smartphone in the WLAN – whether in the home network or on the road via Internet. Functionality, see page 85.

EasyControls is prepared for:

- Manual control elements (KWL-BE, -BEC, accessories).
- Air quality sensors for automatic, demand-driven ventilation (KWL-CO₂, -FTF, -VOC, accessories).
- Connection to central building control systems via integrated Modbus interface or optional KNX module (KWL-KNX, accessories).

■ Electrical connection

Fixed connection via a power cord 3 x 1.5 mm², approx. 2 m long with wire end ferrules. Control line for control elements, sensors, ModBus and LAN to be plugged in on the outside of the unit.

■ Accessories – functional description (details on right)

KWL EC 500 W is individually expandable with the following accessories:

Slide switch controller

- Three speed operation via slide switch.
- Three freely definable operating levels within the entire family of performance curves.
- Via the offset function, the extract fan can be operated with ± 20 % difference.
- Control voltage directly at the controller measurable.
- For the realisation of a further operation level, such as night mode, expandable option with clock timer (WSUP/WSUP-S, No. 9990/9577, accessories).
- Light-emitting diode for optical display of the operating conditions, such as filter change, supply air temperature < +5 °C, errors and operation.

Comfort controller

- Comfort controller with graphic display and user-friendly menu navigation:
- Start-up assistant.
- Selection of speed level (auto/manual, level 1-4).
- Four freely definable operating levels within the entire family of performance curves.
- Setting of weekly program Ventilation/Heating.
- Setting of CO₂-, VOC- and humidity parameter.
- Display of e.g. filter change,

operating conditions, hours of operation and error messages.

- Lock function.

KNX/EIB module

Allows the coupling of the ventilation unit with the central building control system via KNX/EIB.

Room sensor

For the automatic operation and optimal air exchange are sensors available which measure the mixed gas, CO₂-concentration and the relative humidity.

Extension module

For the connection of accessories, such as shutters, under-soil heat exchangers for pre-heating of the outdoor air or a heater battery (optional water- or electric heater battery with maximum 2.6 kW, 230 V, 50 Hz).

Heater battery

Helios easyControls can regulate via an extension module (KWL-EM, accessories) performance-related an electric (EHR with KWL-LTK, accessories) or water heater battery (WHR with WHSH and KWL-LTK, accessories). Temperature profiles are adjustable in the weekly program. Furthermore is a self-sufficient operation of the water heater battery via an air temperature control system (WHST 300 T38, accessories) possible, regardless of Helios easyControls.

■ Notes

Helios easyControls
The innovative KWL®
control concept Page 85

Humidity recovery
by enthalpy heat
exchanger Page 84

KWL EC 220 D



Efficiency class

- A+** KWL EC 220 D R/L with additional room sensor
- A** KWL EC 220 D R/L



KWL EC 220 D R

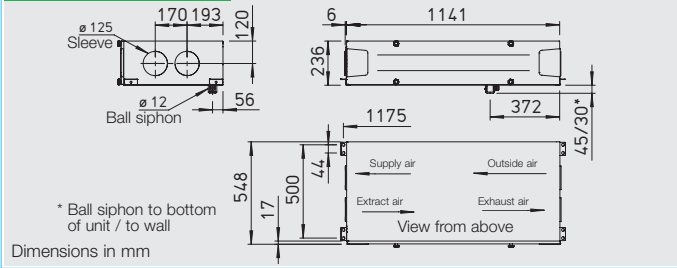

KWL EC 220 D L

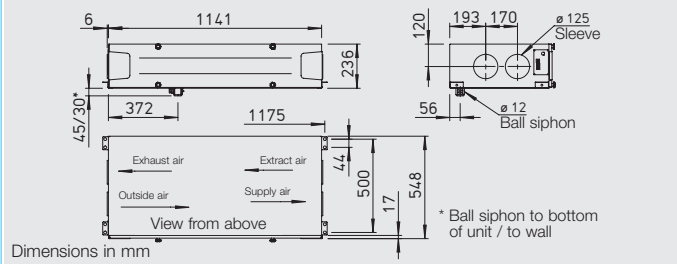

Extremely flat ceiling units with heat recovery for central ventilation of multi-storey buildings and small single-family houses. Certified according to passive-house standards. Equipped with Helios easyControls, the innovative control concept for easiest network connection and web browser operation. With highly efficient polymer heat exchanger and energy-saving EC-motors.

Casing

Made from galvanised steel, white powder coated, double walled, heat and noise insulated (20 mm) on all sides. Easy to install and maintain. The removable side panel allows full access.

Heat exchanger

Due to its large surface area the polymer exchanger provides an exceptionally high efficiency of up to 90 %.

Fans

Two silent and energy-saving centrifugal fans with energy saving EC-motors move the supply air and extract air. They are maintenance free and easy to remove for cleaning.

Ducting

Crossover-free connection of intake-, exhaust-, extract- and supply air ducts with NW 125 mm by means of spigots for connection (RVBD 125 K, accessories).

Condensation outlet

Condensation outlet is located below. Ball siphon included in delivery. To be connected to the drain trap by installer.

Air filter

Supply of cleaned outside air using a G4 filter. Additionally a F7 pollen filter is available. Extract air passes through a G4 filter before entering the heat exchanger.

Summer operation

Comes with automatic bypass function and exchanger cover plate as standard.

Frost protection of heat exchanger

The standard frost monitoring automatically regulates the supply air flow and the optional built-in electric pre-heater battery (KWL-EVH 220 D, accessories).

Helios easyControls

The standard equipment with Helios easyControls allows the simple LAN integration of the KWL-unit into a PC network. The ventilation unit is operated comfortably via the Helios easyControls menu in the web browser, by PC/laptop in the LAN or by Tablet/Smartphone in the WLAN – whether in the home network or on the road via Internet. Functionality, see page 85. EasyControls is prepared for:

- Manual control elements (KWL-BE, -BEC, accessories).
- Air quality sensors for automatic, demand-driven ventilation (KWL-CO₂, -FTF, -VOC, accessories).
- Connection to central building control systems via integrated Modbus interface or optional KNX module (KWL-KNX, accessories).

Electrical connection

Fixed connection via a power cord 3 x 1.5 mm², approx. 2 m long with wire end ferrules. Control line for control elements, sensors, ModBus and LAN to be plugged in on the outside of the unit.

Accessories – functional description (details on right)

KWL EC 220 D is individually expandable with the following accessories:

Slide switch controller

- Three speed operation via slide switch.
- Three freely definable operating levels within the entire family of performance curves.
- Via the offset function, the extract fan can be operated with ± 20 % difference.
- Control voltage directly at the controller measurable.
- For the realisation of a further operation level, such as night mode, expandable option with clock timer (WSUP/WSUP-S, No. 9990/9577, accessories).
- Light-emitting diode for optical display of the operating conditions, such as filter change, supply air temperature < +5 °C, errors and operation.

Comfort controller

- Comfort controller with graphic display and user-friendly menu navigation:
- Start-up assistant.
- Selection of speed level (auto/manual, level 1-4).
- Four freely definable operating levels within the entire family of performance curves.
- Setting of weekly program Ventilation/Heating.
- Setting of CO₂-, VOC- and humidity parameter.

- Display of e.g. filter change, operating conditions, hours of operation and error messages.
- Lock function.

KNX/EIB module

Allows the coupling of the ventilation unit with the central building control system via KNX/EIB.

Room sensor

For the automatic operation and optimal air exchange are sensors available which measure the mixed gas, CO₂-concentration and the relative humidity.

Extension module

For the connection of accessories, such as shutters, under-soil heat exchangers for pre-heating of the outdoor air or a heater battery (optional water- or electric heater battery with maximum 2.6 kW, 230 V, 50 Hz).

Heater battery

Helios easyControls can regulate via an extension module (KWL-EM, accessories) performance-related an electric (EHR with KWL-LTK, accessories) or water heater battery (WHR with WSHH and KWL-LTK, accessories). Temperature profiles are adjustable in the weekly program. Furthermore is a self-sufficient operation of the water heater battery via an air temperature control system (WHST 300 T38, accessories) possible, regardless of Helios easyControls.

Notes

Helios easyControls
The innovative KWL® control concept Page 85

KWL EC 220 D

Frequency	Hz	Total	125	250	500	1k	2k	4k	8k
L _{WA} Extract air	dB(A)	56	29	42	50	42	37	26	16
L _{WA} Supply air	dB(A)	77	46	55	72	67	62	57	44
L _{PA} Case breakout	dB(A)	58	32	51	59	54	47	40	28

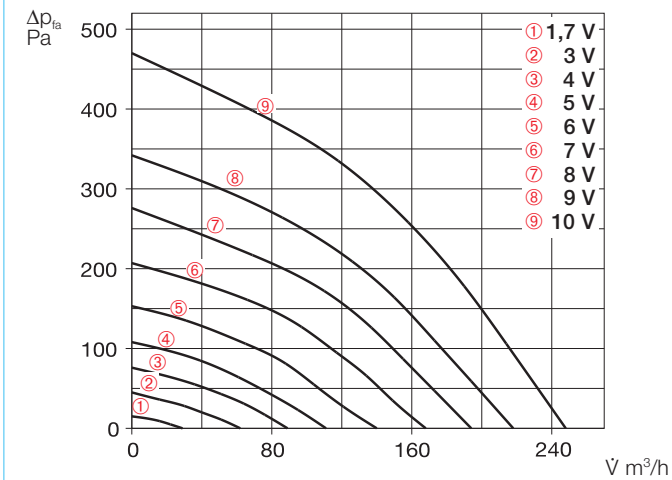

Slide switch controller

Three speed slide switch incl. operation display, for flush installation. Function see on the left. Control line SL 6/3 (length = 3 m) included in delivery, other lengths (SL 6/..., accessories) available for order.

Dim. mm (W x H x D) 80 x 80 x 37
Type KWL-BE Ref. no. 4265

Casing for surface installation

Dim. mm (W x H x D) 83 x 83 x 41
Type KWL-APG Ref. no. 4270



Comfort controller

With graphic display, for flush installation. Function see on the left. Up to 8 pcs. can be installed. Control line SL 4/3 (length = 3 m) included in delivery, other lengths (SL 4/..., accessories) available for order.

Dim. mm (W x H x D) 80 x 80 x 37
Type KWL-BEC Ref. no. 4263

Casing for surface installation

Dim. mm (W x H x D) 83 x 83 x 41
Type KWL-APG Ref. no. 4270



Technical data	KWL EC 220 D R/L		For ceiling installation		
Right-hand version	KWL EC 220 D R		Ref. no. 4226		
Left-hand version	KWL EC 220 D L		Ref. no. 4227		
Air flow volume on step ^{1) 2)}	9	7	5	3	1
Supply/extract air flow vol. V m³/h	245	190	140	90	30
Sound levels dB(A) ³⁾					
Supply air L _{WA} (sound power level)	77	69	61	51	33
Extract air L _{WA} (sound power level)	56	50	43	36	28
Case breakout L _{PA} in 1 m	58	53	45	35	< 25
Fan power 2xW ¹⁾	50	28	16	9	5
Standby power consumption	< 1 W				
Voltage/Frequency	1 ~ 230 V, 50 Hz				
Nom. cur. A	- ventilation 1.2				
	- pre-heater 4.4				
	- max. total 1.2 (5.6 incl. pre-heater, accessories)				
Electric pre-heater kW	1.0 kW (accessories)				
Summer Bypass	automatic (adjustable), with exchanger cover				
Wiring Diagram no.	1043				
Temperature operation range	-20 °C to +40 °C				
Set-up temp.	+5 °C to +40 °C				
Weight approx. kg	50				

¹⁾ At 0 Pa, speed steps adjustable at will.

²⁾ Allow a volume reduction of about 10 % when using a F7 filter.

³⁾ At 100 Pa, sound levels raise with increasing system pressure.

KNX/EIB module

Allows the connection of the ventilation unit to a KNX/EIB central building control system. For switchboard installation (1 space unit required).

Type KWL-KNX Ref. no. 4275



Adapter board

Adapter from ribbon cable to wires or cables. For connection of KNX module and RJ10 control line.

Type KWL-RJ10 KL No. 4277

Room sensor

Measures CO₂, mixed gas- (VOC) concentration or relative humidity. Max. of 8 sensors each can be connected, control according to respective highest measured value. Incl. control line SL 4/3 (length = 3 m), other lengths (SL 4/..., accessories) available for order.

Dim. mm (W x H x D) 95 x 97 x 30

Type KWL-CO₂ Ref. no. 4272

Type KWL-FTF Ref. no. 4273

Type KWL-VOC Ref. no. 4274



A+ required for efficiency class A+

Electric pre-heater battery

Electric pre-heating for simple, plug-in device installation. Allows the pre-heating of the intake air at very low outside temperatures (heat exchanger frost protection). Mandatory for passive houses. Power: 1000 W.

KWL-EVH 220 D Ref. no. 9636



Extension module

For controlling external shutters, undersoil heat exchangers and/or heater batteries. Incl. temperature sensor KWL-LTK and control line KWL-SL 4/3.

Dim. mm (WxHxD) 210x210x100

Type KWL-EM Ref. no. 4269



Electric heater battery

For additional supply air heating.

EHR-R 1,2/125 Ref. no. 9433

Duct temperature sensor

KWL-LTK (1 pc. required.) No. 9644

Water heater battery

For additional supply air heating.

Type WHR 125 Ref. no. 9480

Duct temperature sensor

KWL-LTK (2 pcs. required.) No. 9644

Hydraulic unit

WHSH HE 24 V (0-10V) No. 8318

Alternative:

Air temperature control

WHST 300 T38 Ref. no. 8817

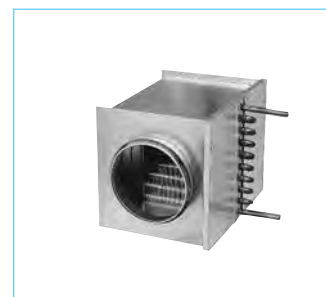

Replacement air filter

- 2 pcs. **G4-Filter**

ELF-KWL 220 D/4/4 No. 9638

- 1 pc. **F7-Filter**

ELF-KWL 220 D/7²⁾ No. 9639

Duct connector

Connector with sealing to ducting with Ø 125 mm.

RVBD 125 K No. 3414

Other accessories Page

KWL® periphery	114 on
- Undersoil heat exch.	118 on
- Insulated duct system	122 on
- Air distribution systems	126 on
- Control lines, a.o.	136 on
Heater battery, -control	426 on
grilles, ducting,	
roof terminations,	487 on
Extract air elements,	
Design valves	500 on

KWL EC 340 D

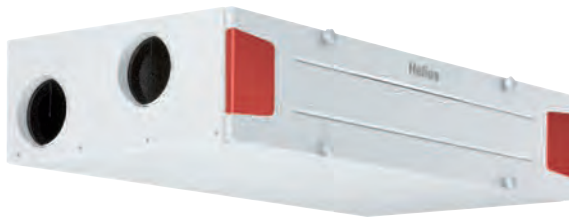

Efficiency class

- A+** KWL EC 340 D R/L with additional room sensor
- A** KWL EC 340 D R/L



KWL EC 340 D R

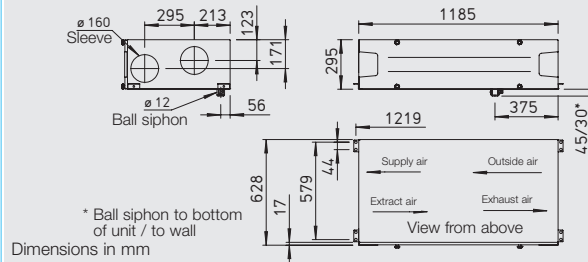

KWL EC 340 D L

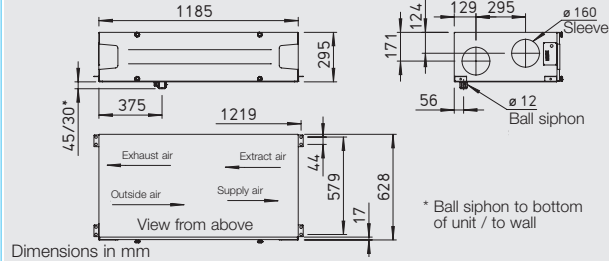

Extremely flat ceiling units with heat recovery for central ventilation of multi-storey buildings and small single-family houses. Equipped with Helios easyControls, the innovative control concept for easiest network connection and web browser operation. With highly efficient polymer heat exchanger and energy-saving EC-motors.

■ Casing

Made from galvanised steel, white powder coated, double walled, heat and noise insulated (20 mm) on all sides. Easy to install and maintain. The removable side panel allows full access.

■ Heat exchanger

Due to its large surface area the polymer exchanger provides an exceptionally high efficiency of up to 90 %.

■ Fans

Two silent and energy-saving centrifugal fans with energy saving EC-motors move the supply air and extract air. They are maintenance free and easy to remove for cleaning.

■ Ducting

Crossover-free connection of intake-, exhaust-, extract- and supply air ducts with NW 160 mm by means of spigots for connection (RVBD 160 K, accessories).

■ Condensation outlet

Condensation outlet is located below. Ball siphon included in delivery. To be connected to the drain trap by installer.

■ Air filter

Supply of cleaned outside air using a G4 filter. Additionally a F7 pollen filter is available. Extract air passes through a G4 filter before entering the heat exchanger.

■ Summer operation

Comes with automatic bypass function and exchanger cover plate as standard.

■ Frost protection of heat exchanger

The standard frost monitoring automatically regulates the supply air flow and the optional built-in electric pre-heater battery (KWL-EVH 340 D, accessories).

■ Helios easyControls

The standard equipment with Helios easyControls allows the simple LAN integration of the KWL-unit into a PC network. The ventilation unit is operated comfortably via the Helios easyControls menu in the web browser, by PC/laptop in the LAN or by Tablet/Smartphone in the WLAN – whether in the home network or on the road via Internet. Functionality, see page 85.

EasyControls is prepared for:

- Manual control elements (KWL-BE, -BEC, accessories).
- Air quality sensors for automatic, demand-driven ventilation (KWL-CO₂, -FTF, -VOC, accessories).
- Connection to central building control systems via integrated Modbus interface or optional KNX module (KWL-KNX, accessories).

■ Electrical connection

Fixed connection via a power cord 3 x 1.5 mm², approx. 2 m long with wire end ferrules. Control line for control elements, sensors, ModBus and LAN to be plugged in on the outside of the unit.

■ Accessories – functional description (details on right)

KWL EC 340 D is individually expandable with the following accessories:

□ Slide switch controller

- Three speed operation via slide switch.
- Three freely definable operating levels within the entire family of performance curves.
- Via the offset function, the extract fan can be operated with ± 20 % difference.
- Control voltage directly at the controller measurable.
- For the realisation of a further operation level, such as night mode, expandable option with clock timer (WSUP/WSUP-S, No. 9990/9577, accessories).
- Light-emitting diode for optical display of the operating conditions, such as filter change, supply air temperature < +5 °C, errors and operation.

□ Comfort controller

- Comfort controller with graphic display and user-friendly menu navigation:
- Start-up assistant.
- Selection of speed level (auto/manual, level 1-4).
- Four freely definable operating levels within the entire family of performance curves.
- Setting of weekly program Ventilation/Heating.
- Setting of CO₂-, VOC- and humidity parameter.

- Display of e.g. filter change, operating conditions, hours of operation and error messages.
- Lock function.

□ KNX/EIB module

Allows the coupling of the ventilation unit with the central building control system via KNX/EIB.

□ Room sensor

For the automatic operation and optimal air exchange are sensors available which measure the mixed gas, CO₂-concentration and the relative humidity.

□ Extension module

For the connection of accessories, such as shutters, under-soil heat exchangers for pre-heating of the outdoor air or a heater battery (optional water- or electric heater battery with maximum 2.6 kW, 230 V, 50 Hz).

□ Heater battery

Helios easyControls can regulate via an extension module (KWL-EM, accessories) performance-related an electric (EHR with KWL-LTK, accessories) or water heater battery (WHR with WSHS and KWL-LTK, accessories). Temperature profiles are adjustable in the weekly program. Furthermore is a self-sufficient operation of the water heater battery via an air temperature control system (WHST 300 T38, accessories) possible, regardless of Helios easyControls.

■ Notes

Helios easyControls
The innovative KWL®
control concept

KWL EC 340 D

Frequency	Hz	total	125	250	500	1k	2k	4k	8k
L _{WA} Extract air	dB(A)	59	41	53	54	52	47	36	34
L _{WA} Supply air	dB(A)	79	56	70	76	72	66	57	51
L _{PA} Case breakout	dB(A)	58	36	47	56	51	42	28	20

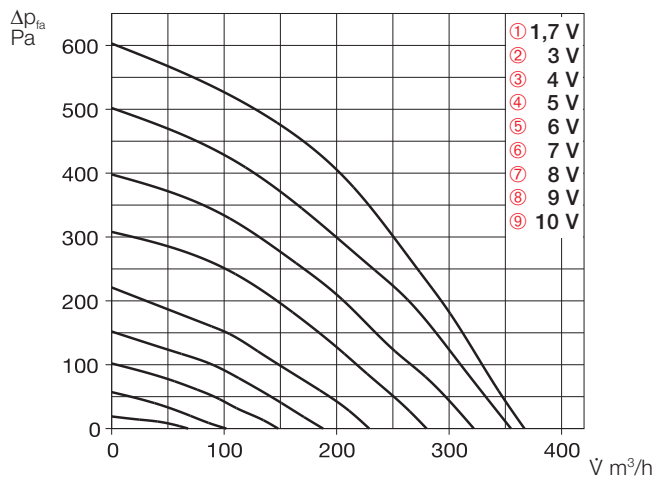

Slide switch controller

Three speed slide switch incl. operation display, for flush installation. Function see on the left. Control line SL 6/3 (length = 3 m) included in delivery, other lengths (SL 6/..., accessories) available for order.

Dim. mm (W x H x D) 80 x 80 x 37
Type KWL-BE Ref. no. 4265

Casing for surface installation

Dim. mm (W x H x D) 83 x 83 x 41
Type KWL-APG Ref. no. 4270



Comfort controller

With graphic display, for flush installation. Function see on the left. Up to 8 pcs. can be installed. Control line SL 4/3 (length = 3 m) included in delivery, other lengths (SL 4/..., accessories) available for order.

Dim. mm (W x H x D) 80 x 80 x 37
Type KWL-BEC Ref. no. 4263

Casing for surface installation

Dim. mm (W x H x D) 83 x 83 x 41
Type KWL-APG Ref. no. 4270



Technical data	KWL EC 340 D R/L	For ceiling installation	
Right-hand version	KWL EC 340 D R	Ref. no. 4237	
Left-hand version	KWL EC 340 D L	Ref. no. 4238	
Air flow volume on step ^{1) 2)}	③	...	①
Supply/extract air flow vol. V m³/h	380	...	100
Sound levels dB(A) ³⁾			
Supply air L _{WA} (sound power level)	79	...	ns
Extract air L _{WA} (sound power level)	59	...	ns
Case breakout L _{PA} in 1 m	58	...	ns
Fan power 2xW ¹⁾	80	...	12
Standby power consumption	< 1 W		
Voltage/Frequency	1 ~ 230 V, 50 Hz		
Nom. cur. A		2,4	
– ventilation		4,4	
– pre-heater			
– max. total	2,4 (6,6 incl. pre-heater, accessories)		
Electric pre-heater kW	1,0 kW (accessories)		
Summer Bypass	automatic (adjustable), with exchanger cover		
Wiring Diagram no.	1043		
Temperature operation range	–20 °C to +40 °C		
Set-up temp.	+5 °C to +40 °C		
Weight approx. kg	70		

¹⁾ At 0 Pa, speed steps adjustable at will.

²⁾ Allow a volume reduction of about 10 % when using a F7 filter.

³⁾ At 100 Pa, sound levels raise with increasing system pressure.

KNX/EIB module

Allows the connection of the ventilation unit to a KNX/EIB central building control system. For switchboard installation (1 space unit required).

Type KWL-KNX Ref. no. 4275



Adapter board

Adapter from ribbon cable to wires or cables. For connection of KNX module and RJ10 control line.

Type KWL-RJ10 KL No. 4277

Room sensor

Measures CO₂, mixed gas- (VOC) concentration or relative humidity. Max. of 8 sensors each can be connected, control according to respective highest measured value. Incl. control line SL 4/3 (length = 3 m), other lengths (SL 4/..., accessories) available for order.

Dim. mm (W x H x D) 95 x 97 x 30

Type KWL-CO₂ Ref. no. 4272

Type KWL-FTF Ref. no. 4273

Type KWL-VOC Ref. no. 4274



A+ required for efficiency class A+

Electric pre-heater battery

Electric pre-heating for simple, plug-in device installation. Allows the pre-heating of the intake air at very low outside temperatures (heat exchanger frost protection). Mandatory for passive houses. Power: 1000 W.

KWL-EVH 340 D Ref. no. 4241



Extension module

For controlling external shutters, undersoil heat exchangers and/or heater batteries. Incl. temperature sensor KWL-LTK and control line KWL-SL 4/3.

Dim. mm (WxHxD) 210x210x100

Type KWL-EM Ref. no. 4269



Electric heater battery

For additional supply air heating.

EHR-R 2,4/160 Ref. no. 9435

Duct temperature sensor

KWL-LTK (1 pc. required.) No. 9644

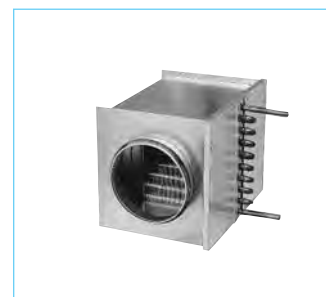

Water heater battery

For additional supply air heating.

Type WHR 160 Ref. no. 9481

Duct temperature sensor

KWL-LTK (2 pcs. required.) No. 9644

Hydraulic unit

WHSH HE 24 V (0-10V) No. 8318

Alternative:

Air temperature control

WHST 300 T38 Ref. no. 8817

Replacement air filter

– 2 pcs. **G4-Filter**

ELF-KWL 340 D/4/4 No. 4239

– 1 pc. **F7-Filter**

ELF-KWL 340 D/7²⁾ No. 4240

Duct connector

Connector with sealing to connect unit to ducting with Ø 160 mm.

RVBD 160 K No. 3415

Other accessories

Other accessories	Page
KWL® periphery	114 on
– Undersoil heat exch.	118 on
– Insulated duct system	122 on
– Air distribution systems	126 on
– Control lines, a.o.	136 on
Heater battery, -control	426 on
grilles, ducting,	
roof terminations,	487 on
Extract air elements,	
Design valves	500 on

KWL EC 700 D



KWL EC 700 D

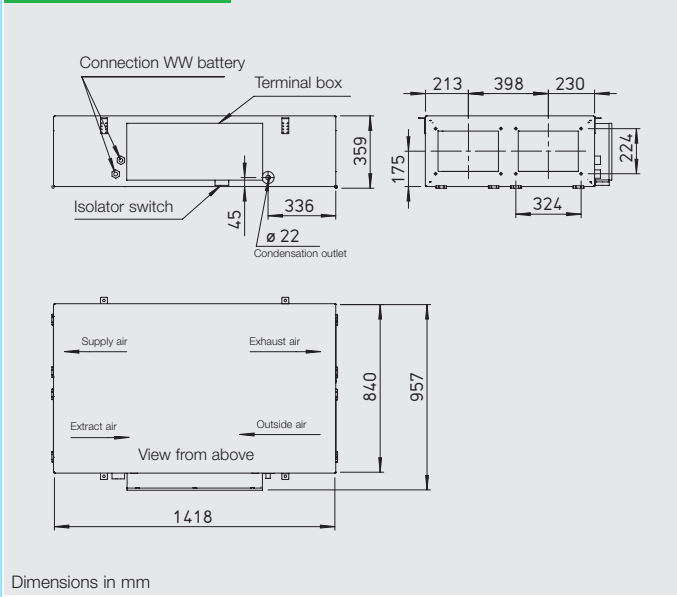

Extremely flat ventilation unit with heat recovery for compact and space saving ceiling installation. With wide range of application in apartments, commercial and industrial applications. Independently certified hygienic properties and energy efficiency according to VDI 6022 and passive house standard. Unit design and components meet the general hygienic requirements in VDI 6022. In different comfort- and equipment versions.

■ **Casing**

Made from galvanised steel, white powder coated, double walled, heat and noise insulated (30 mm) on all sides. Easy to install and maintain. The removable side panel allows full access. Ceiling installation with the vibration-reducing fastening elements contained in the scope of delivery.

■ **Heat exchanger**

Due to its large surface area the polymer exchanger provides an exceptionally high efficiency of up to 90 %.

■ **Fans**

Two silent EC high-performance fans with backward curved impellers guarantee high energy efficiency. The special control technology allows constant volume or constant pressure regulation.

■ **Ducting**

Installation-friendly connection of the ducting for intake, exhaust, extract and supply air using ducts with nominal diameter of 250 mm.

■ **Condensation outlet**

A separate condensation collector below the heat exchanger makes maintenance work easier. Condensation outlet is located next to terminal box. Ball siphon included in delivery. To be connected to drain pipe by installer.

■ **Air filter**

Standard equipment: Supply of cleaned outside air using a F7 filter. Extract air passes through a M5 filter before entering the heat exchanger. All filters are pressure monitored and are easy to remove.

■ **Summer operation**

Comes with automatic bypass function for maximum comfort as standard.

■ **Frost protection of heat exchanger**

A electric pre-heater battery heats the intake air when the temperature is too low. This prevents ice from building up in the heat exchanger and ensures optimal heat recovery during the complete heating period.

■ **Speed control**

The comfort controller for surface mounting with touchscreen (included in delivery) and user-friendly menu navigation makes the following functions possible:

- Operation directly via touchscreen.
 - Freely definable operating levels within the performance curve values.
 - Choice between constant air flow volume or constant pressure regulation.
 - Demand-driven ventilation using CO₂-, VOC (mixed gas) or humidity sensor.
 - Initial start-up (automatic determination of the system performance curve).
 - Control of external shutters.
 - Connection of a fire alarm contact.
 - Weekly or daily program.
 - Pressure monitoring of filter pollution.
 - Display of required filter change, operating state, error messages.
 - Different access levels.
- Alternatively the ventilation unit can be controlled via ModBus (RS 485).

■ **Electrical connection**

Easily accessible terminal box located on the side of the casing. Isolator switch, lockable via padlock, for maintenance work can be operated from the underside of the unit.

■ **Heater battery**

Type KWL EC Pro WW

The integrated water heater battery provides a comfortable and energy-efficient heating of the supply air. The target temperature simply is set at the controller. For the control of the water heater battery the use of the hydraulic unit WSHH HE 24 V (0-10 V), accessories, is recommended.

■ **Note**

The fan design according to VDI 6022 requires the use of VDI 6022 compliant air filters. Therefore, the use of original replacement air filters (see following page) is obligatory.

KWL EC 700 D

Frequency	Hz	Total	125	250	500	1k	2k	4k	8k
L _{WA} Extract air	dB(A)	53	46	49	47	41	40	34	23
L _{WA} Supply air	dB(A)	68	54	65	63	59	53	48	39
L _{PA} Case breakout	dB(A)	47	26	34	35	35	29	22	8

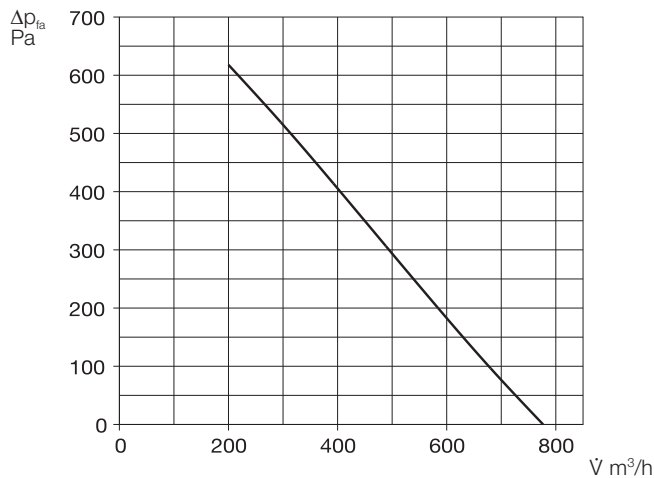

■ Included in delivery Comfort controller for surface mounting

User-friendly operation over self-describing graphic elements with plain text directly at the touch-screen. Control line SL 6/5 (length = 5 m) included in delivery, other lengths (SL 6/..., accessories) available for order.



■ Accessories for type Pro WW Hydraulic unit

Controls the flow of the water heater battery by means of three point valve actuator 24 V (0-10 V) and in this way the thermal output which is conveyed to the air. Delivery as complete unit, incl. flow-/return temp. display, circulation pump and flexible connecting pipes.

WHSH HE 24 V (0-10 V) No. 8318



■ Accessories for all types Room sensor

Measures CO₂-, mixed gas (VOC) concentration or relative humidity and controls the ventilation unit according to setpoint. Max. one sensor can be attached.

Dim. mm (W x H x D) 95 x 97 x 30

- Type KWL-CO₂ Ref. no. 4272
- Type KWL-FTF Ref. no. 4273
- Type KWL-VOC Ref. no. 4274



Adapter piece – symmetrical from rectangular unit flange to ducting.

Type KWL-ÜS 700 D No. 4206

Flexible sleeve

To reduce vibration transmission, incl. 2 worm drive clips.

Type FM 250 Ref. no. 1672

Flange ring from galvanised sheet steel for duct connection.

Type FR 250 Ref. no. 1203

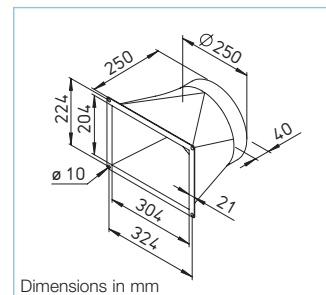

Back draught shutter, motorised

Prevents inflow of cold air when unit stopped. Automatic operation when fan is in use. Comes with built-on spring release motor (installed outside the airflow). To be installed in any position. Closing pressure adjustable according to fan power and mounting position.

Type RVM 250 Ref. no. 2576



■ Replacement air filter

- 1 pc. M5-Filter (F5)
ELF-KWL 700 D/5 VDI No. 4189
- 1 pc. F7-Filter
ELF-KWL 700 D/7 VDI No. 4191

■ Other accessories Page

KWL® periphery	114 on
– Air distribution systems	126 on
– Further overview, Control lines	136 on

Accessories-Details

Grilles, ducting, fittings, bushings,	487 on
extract air elements	136, 500 on

Technical data	KWL EC 700 D			KWL EC 700 D with water heater battery		
	Type	Ref. no.		Type	Ref. no.	
For ceiling installation	KWL EC 700 D Pro	4171		KWL EC 700 D Pro WW	4172	
Air flow volume on step¹⁾ Supply/extract air flow vol. V m³/h approx.	③	②	①	③	②	①
	510	330	210	510	330	210
Sound levels dB(A)²⁾						
Supply air L _{WA} (sound power level)	68	64	55	68	64	55
Extract air L _{WA} (sound power level)	53	47	37	53	47	37
Case breakout L _{PA} in 1 m	47	ns	ns	47	ns	ns
Fan power 2 x W	110	60	38	110	60	38
Voltage/Frequency	230 V ~, 50 Hz			230 V ~, 50 Hz		
Nom. cur. A – ventilation	2.6			2.6		
– pre-heater	9.6			9.6		
– max. total	12.2			12.2		
Heat power/heater battery kW	—			2.3 (at 60/40 °C) / 2.1 (at 50/40 °C) / 1.3 (at 40/30 °C)		
Electric pre-heater kW	2.2			2.2		
Summer Bypass	automatic			automatic		
Wiring Diagram no.	1062			1062		
Temperature operation range	–20 °C to +40 °C			–20 °C to +40 °C		
Connection PWW heater battery	—			IG 1/2"		
Weight approx. kg	110			115		

¹⁾ Figures relate to the operational range defined to PHI (Passive House Institute). ²⁾ at 100 Pa.

KWL EC 1400 D



KWL EC 1400 D

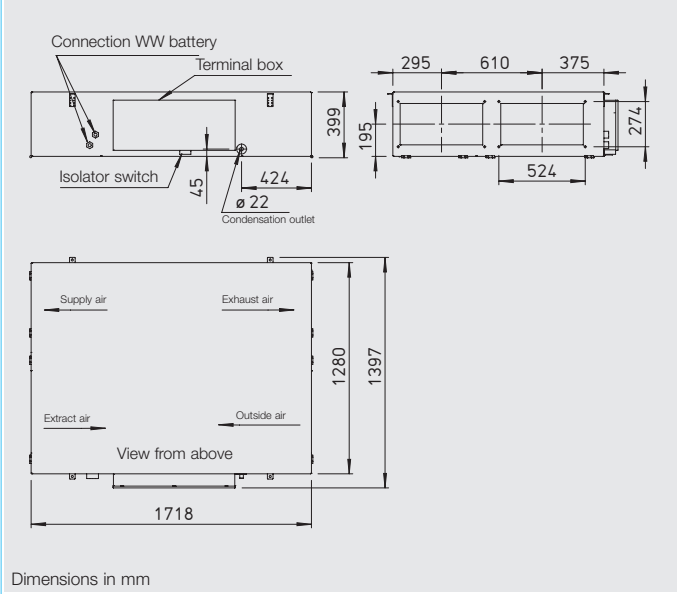

Extremely flat ventilation unit with heat recovery for compact and space saving ceiling installation. With wide range of application in apartments, commercial and industrial applications. Independently certified hygienic properties and energy efficiency according to VDI 6022 and passive house standard. Unit design and components meet the general hygienic requirements in VDI 6022. In different comfort- and equipment versions.

■ **Casing**

Made from galvanised steel, white powder coated, double walled, heat and noise insulated (30 mm) on all sides. Easy to install and maintain. The removable side panel allows full access.

Ceiling installation with the vibration-reducing fastening elements contained in the scope of delivery.

■ **Heat exchanger**

Due to its large surface area the polymer exchanger provides an exceptionally high efficiency of up to 90 %.

■ **Fans**

Two silent EC high-performance fans with backward curved impellers guarantee high energy efficiency. The special control technology allows constant volume or constant pressure regulation.

■ **Ducting**

Installation-friendly connection of the ducting for intake, exhaust, extract and supply air using ducts with nominal diameter of 315 mm.

■ **Condensation outlet**

A separate condensation collector below the heat exchanger makes maintenance work easier. Condensation outlet is located next to terminal box. Ball siphon included in delivery. To be connected to drain pipe by installer.

■ **Air filter**

Standard equipment: Supply of cleaned outside air using a F7 filter. Extract air passes through a M5 filter before entering the heat exchanger. All filters are pressure monitored and are easy to remove.

■ **Summer operation**

Comes with automatic bypass function for maximum comfort as standard.

■ **Frost protection of heat exchanger**

A electric pre-heater battery heats the intake air when the temperature is too low. This prevents ice from building up in the heat exchanger and ensures optimal heat recovery during the complete heating period.

■ **Speed control**

The comfort controller for surface mounting with touchscreen (included in delivery) and user-friendly menu navigation makes the following functions possible:

- Operation directly via touchscreen.
 - Freely definable operating levels within the performance curve values.
 - Choice between constant air flow volume or constant pressure regulation.
 - Demand-driven ventilation using CO₂-, VOC (mixed gas) or humidity sensor.
 - Initial start-up (automatic determination of the system performance curve).
 - Control of external shutters.
 - Connection of a fire alarm contact.
 - Weekly or daily program.
 - Pressure monitoring of filter pollution.
 - Display of required filter change, operating state, error messages.
 - Different access levels.
- Alternatively the ventilation unit can be controlled via ModBus (RS 485).

■ **Electrical connection**

Easily accessible terminal box located on the side of the casing. Isolator switch, lockable via padlock, for maintenance work can be operated from the underside of the unit.

■ **Heater battery**

Type KWL EC Pro WW

The integrated water heater battery provides a comfortable and energy-efficient heating of the supply air. The target temperature simply is set at the controller.

For the control of the water heater battery the use of the hydraulic unit WSH HE 24 V (0-10 V), accessories, is recommended.

■ **Note**

The fan design according to VDI 6022 requires the use of VDI 6022 compliant air filters. Therefore, the use of original replacement air filters (see following page) is obligatory.

KWL EC 1400 D

Frequency	Hz	Total	125	250	500	1k	2k	4k	8k	
L _{WA} Extract air		dB(A)	60	51	53	53	50	51	49	45
L _{WA} Supply air		dB(A)	80	63	68	71	71	75	71	70
L _{PA} Case breakout		dB(A)	53	34	43	40	41	38	26	15

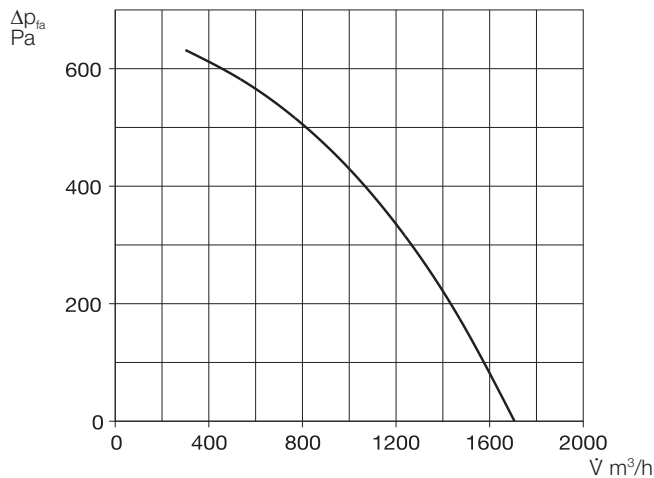

Included in delivery Comfort controller for surface mounting

User-friendly operation over self-describing graphic elements with plain text directly at the touch-screen. Control line SL 6/5 (length = 5 m) included in delivery, other lengths (SL 6/..., accessories) available for order.



Accessories for type Pro WW Hydraulic unit

Controls the flow of the water heater battery by means of three point valve actuator 24 V (0-10 V) and in this way the thermal output which is conveyed to the air. Delivery as complete unit, incl. flow-/return temp. display, circulation pump and flexible connecting pipes.

WHSHE 24 V (0-10 V) No. 8318



Accessories for all types Room sensor

Measures CO₂-, mixed gas (VOC) concentration or relative humidity and controls the ventilation unit according to setpoint. Max. one sensor can be attached.

Dim. mm (W x H x D) 95 x 97 x 30

- Type KWL-CO₂ Ref. no. 4272
- Type KWL-FTF Ref. no. 4273
- Type KWL-VOC Ref. no. 4274



Adapter piece – symmetrical from rectangular unit flange to ducting.

Type KWL-ÜS 1400 D No. 4207

Flexible sleeve

To reduce vibration transmission, incl. 2 worm drive clips.

Type FM 315 Ref. no. 1674

Flange ring from galvanised sheet steel for duct connection.

Type FR 315 Ref. no. 1204

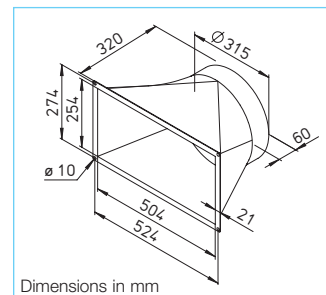

Dimensions in mm

Back draught shutter, motorised

Prevents inflow of cold air when unit stopped. Automatic operation when fan is in use. Comes with built-on spring release motor (installed outside the airflow). To be installed in any position. Closing pressure adjustable according to fan power and mounting position.

Type RVM 315 Ref. no. 2578



Replacement air filter

- 1 pc. M5-Filter (F5)
ELF-KWL 1400 D/5 VDI No. 4193
- 1 pc. F7-Filter
ELF-KWL 1400 D/7 VDI No. 4195

Other accessories Page

- KWL® periphery 114 on
- Air distribution systems 126 on
- Further overview, Control lines 136 on

Accessories-Details

- Grilles, ducting, fittings, bushings, 487 on
- extract air elements 136, 500 on

Technical data	KWL EC 1400 D			KWL EC 1400 D with water heater battery		
	Type	Ref. no.		Type	Ref. no.	
For ceiling installation	KWL EC 1400 D Pro	4173		KWL EC 1400 D Pro WW	4174	
Air flow volume on step¹⁾ Supply/extract air flow vol. \dot{V} m ³ /h approx.	③	②	①	③	②	①
	1000	650	400	1000	650	400
Sound levels dB(A)²⁾						
Supply air L _{WA} (sound power level)	80	71	60	80	71	60
Extract air L _{WA} (sound power level)	60	51	39	60	51	39
Case breakout L _{PA} in 1 m	53	ns	ns	53	ns	ns
Fan power 2 x W	225	140	80	225	140	80
Voltage/Frequency	3 N – 400 V, 50 Hz			3 N – 400 V, 50 Hz		
Nom. cur. A – ventilation	6.2 / – / –			6.2 / – / –		
– pre-heater	– / 11.25 / 11.25			– / 11.25 / 11.25		
– max. total	6.2 / 11.25 / 11.25			6.2 / 11.25 / 11.25		
Heat power/heater battery kW	—			4.7 (at 60/40 °C) / 4.2 (at 50/40 °C) / 2.7 (at 40/30 °C)		
Electric pre-heater kW	—			4.5		
Summer Bypass	—			automatic		
Wiring diagram no.	—			1063		
Temperature operation range	—			–20 °C to +40 °C		
Connection PWW heater battery	—			IG 1/2"		
Weight approx. kg	—			185		
	—			190		

¹⁾ Figures relate to the operational range defined to PHI (Passive House Institute). ²⁾ at 215 Pa.

KWL EC 2000 D



KWL EC 2000 D

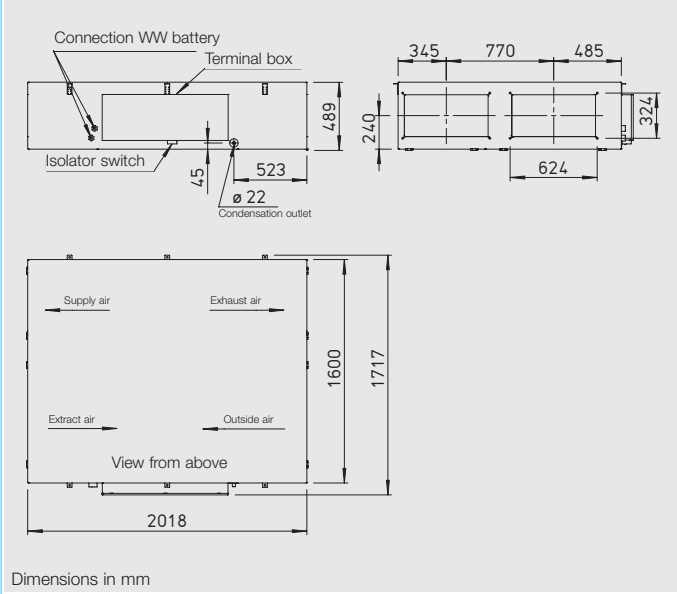

Extremely flat ventilation unit with heat recovery for compact and space saving ceiling installation. With wide range of application in apartments, commercial and industrial applications. Independently certified hygienic properties and energy efficiency according to VDI 6022 and passive house standard. Unit design and components meet the general hygienic requirements in VDI 6022. In different comfort- and equipment versions.

■ **Casing**

Made from galvanised steel, white powder coated, double walled, heat and noise insulated (30 mm) on all sides. Easy to install and maintain. The removable side panel allows full access. Ceiling installation with the vibration-reducing fastening elements contained in the scope of delivery.

■ **Heat exchanger**

Due to its large surface area the polymer exchanger provides an exceptionally high efficiency of up to 90 %.

■ **Fans**

Two silent EC high-performance fans with backward curved impellers guarantee high energy efficiency. The special control technology allows constant volume or constant pressure regulation.

■ **Ducting**

Installation-friendly connection of the ducting for intake, exhaust, extract and supply air using ducts with nominal diameter of 400 mm.

■ **Condensation outlet**

A separate condensation collector below the heat exchanger makes maintenance work easier. Condensation outlet is located next to terminal box. Ball siphon included in delivery. To be connected to drain pipe by installer.

■ **Air filter**

Standard equipment: Supply of cleaned outside air using a F7 filter. Extract air passes through a M5 filter before entering the heat exchanger. All filters are pressure monitored and are easy to remove.

■ **Summer operation**

Comes with automatic bypass function for maximum comfort as standard.

■ **Frost protection of heat exchanger**

A electric pre-heater battery heats the intake air when the temperature is too low. This prevents ice from building up in the heat exchanger and ensures optimal heat recovery during the complete heating period.

■ **Speed control**

The comfort controller for surface mounting with touchscreen (included in delivery) and user-friendly menu navigation makes the following functions possible:

- Operation directly via touchscreen.
 - Freely definable operating levels within the performance curve values.
 - Choice between constant air flow volume or constant pressure regulation.
 - Demand-driven ventilation using CO₂-, VOC (mixed gas) or humidity sensor.
 - Initial start-up (automatic determination of the system performance curve).
 - Control of external shutters.
 - Connection of a fire alarm contact.
 - Weekly or daily program.
 - Pressure monitoring of filter pollution.
 - Display of required filter change, operating state, error messages.
 - Different access levels.
- Alternatively the ventilation unit can be controlled via ModBus (RS 485).

■ **Electrical connection**

Easily accessible terminal box located on the side of the casing. Isolator switch, lockable via padlock, for maintenance work can be operated from the underside of the unit.

■ **Heater battery**

Type KWL EC Pro WW

The integrated water heater battery provides a comfortable and energy-efficient heating of the supply air. The target temperature simply is set at the controller. For the control of the water heater battery the use of the hydraulic unit WSH HE 24 V (0-10 V), accessories, is recommended.

■ **Note**

The fan design according to VDI 6022 requires the use of VDI 6022 compliant air filters. Therefore, the use of original replacement air filters (see following page) is obligatory.

KWL EC 2000 D

Frequency	Hz	Total	125	250	500	1k	2k	4k	8k
L _{WA} Extract air		dB(A)	59	56	52	48	49	47	40
L _{WA} Supply air		dB(A)	77	66	68	67	72	69	64
L _{PA} Case breakout		dB(A)	56	34	36	38	41	42	15

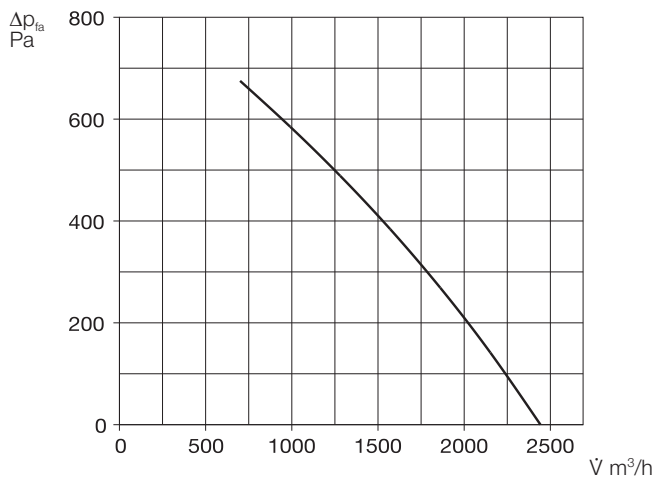

■ Included in delivery Comfort controller for surface mounting

User-friendly operation over self-describing graphic elements with plain text directly at the touch-screen. Control line SL 6/5 (length = 5 m) included in delivery, other lengths (SL 6/..., accessories) available for order.



■ Accessories for type Pro WW Hydraulic unit

Controls the flow of the water heater battery by means of three point valve actuator 24 V (0-10 V) and in this way the thermal output which is conveyed to the air. Delivery as complete unit, incl. flow-/return temp. display, circulation pump and flexible connecting pipes.

WHSHE 24 V (0-10 V) No. 8318



■ Accessories for all types Room sensor

Measures CO₂-, mixed gas (VOC) concentration or relative humidity and controls the ventilation unit according to setpoint. Max. one sensor can be attached.

Dim. mm (W x H x D) 95 x 97 x 30

Type KWL-CO₂ Ref. no. 4272

Type KWL-FTF Ref. no. 4273

Type KWL-VOC Ref. no. 4274



Adapter piece – symmetrical from rectangular unit flange to ducting.

Type KWL-ÜS 2000 D No. 4208

Flexible sleeve

To reduce vibration transmission, incl. 2 worm drive clips.

Type FM 400 Ref. no. 1676

Flange ring from galvanised sheet steel for duct connection.

Type FR 400 Ref. no. 1206

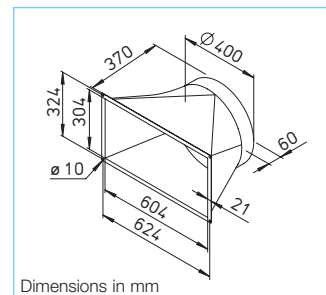

Back draught shutter, motorised

Prevents inflow of cold air when unit stopped. Automatic operation when fan is in use. Comes with built-on spring release motor (installed outside the airflow). To be installed in any position. Closing pressure adjustable according to fan power and mounting position.

Type RVM 400 Ref. no. 2580



■ Replacement air filter

– 1 pc. **M5-Filter (F5)**

ELF-KWL 2000 D/5 VDI No. 4197

– 1 pc. **F7-Filter**

ELF-KWL 2000 D/7 VDI No. 4204

■ Other accessories Page

KWL® periphery	114 on
– Air distribution systems	126 on
– Further overview, Control lines	136 on

Accessories-Details

Grilles, ducting, fittings, bushings,	487 on
extract air elements	136, 500 on

Technical data	KWL EC 2000 D			KWL EC 2000 D with water heater battery		
	Type	Ref. no.		Type	Ref. no.	
For ceiling installation	KWL EC 2000 D Pro	4175		KWL EC 2000 D Pro WW	4176	
Air flow volume on step¹⁾ Supply/extract air flow vol. V m ³ /h approx.	③	②	①	③	②	①
	1800	1150	720	1800	1150	720
Sound levels dB(A)²⁾						
Supply air L _{WA} (sound power level)	77	67	57	77	67	57
Extract air L _{WA} (sound power level)	59	50	40	59	50	40
Case breakout L _{PA} in 1 m	56	ns	ns	56	ns	ns
Fan power 2 x W	395	245	150	395	245	150
Voltage/Frequency	3 N – 400 V, 50 Hz			3 N – 400 V, 50 Hz		
Nom. cur. A – ventilation	2.3 / 2.3 / 2.3			2.3 / 2.3 / 2.3		
– pre-heater	10.1 / 10.1 / 10.1			10.1 / 10.1 / 10.1		
– max. total	12.4 / 12.4 / 12.4			12.4 / 12.4 / 12.4		
Heat power/heater battery kW	—			8.1 (at 60/40 °C) / 7.3 (at 50/40 °C) / 4.6 (at 40/30 °C)		
Electric pre-heater kW	—			7.0		
Summer Bypass	automatic			automatic		
Wiring diagram no.	1064			1064		
Temperature operation range	–20 °C to +40 °C			–20 °C to +40 °C		
Connection PWW heater battery	—			IG 1/2"		
Weight approx. kg	265			270		

¹⁾ Figures relate to the operational range defined to PHI (Passive House Institute). ²⁾ at 250 Pa.

KWL EC 800 S



KWL EC 800 S with base cover (Accessories)

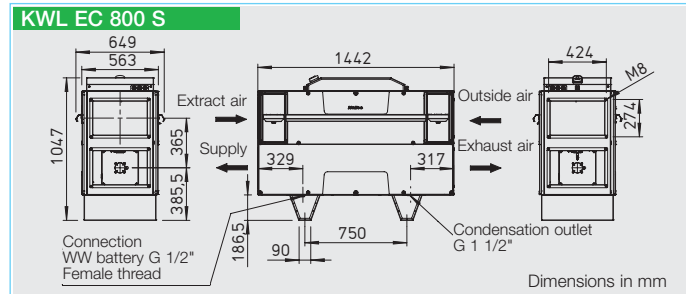

Central ventilation units with heat recovery for compact and space-saving floor installation (vertical). With wide range of application in apartments, commercial and industrial applications. Independently certified hygienic properties and energy efficiency according to VDI 6022 and passive house standard. Unit design and components meet the general hygienic requirements in VDI 6022. Integrated water heater battery optional.

■ Casing

Made from galvanised sheet steel. Heat and noise insulated with 30 mm thick mineral wool. Inspection openings for filter change at the two side doors which can be opened optionally without tool or using a socket wrench. Both sides panels are completely removable for free access of all elements. The unit is suitable for the vertical floor installation in the interior. Anti vibration mounts can be placed below (on site) to prevent the direct transmission of vibration and structure-borne noise on parts of the building.

■ Heat exchanger

Large surface cross counterflow heat exchanger from aluminium with an efficiency up to 90 %. Easy to remove.

■ Fans

Two silent highly efficient EC fans with backward curved impellers ensure highest efficiency. The special control system make a constant air flow volume or constant pressure regulation possible.

■ Ducting

Installation-friendly connection of the ducting for intake, exhaust, extract and supply air using ducts with nominal diameter of 250 mm. The unit can be installed either way round, so that intake- and exhaust air as well as extract- and supply air connections can be left or right.

■ Condensation outlet

The unit is equipped with a condensate tray with a condensate tray made from high quality steel. The condensation outlet is located at the bottom. Ball siphon included in delivery. To be connected to drain pipe by installer.

■ Air filter

Standard equipment: Supply of cleaned outside air using a F7 filter. Extract air passes through a M5 filter before entering the heat exchanger. All filters are pressure monitored and are easy to remove.

■ Summer operation

Comes with automatic bypass function for maximum comfort as standard.

■ Frost protection of heat exchanger

An electric pre-heater battery heats the intake air when the temperature is too low. This prevents ice from building up in the heat exchanger and ensures optimal heat recovery during the complete heating period.

■ Speed control

- The comfort controller for surface mounting with touchscreen (included in delivery) and user-friendly menu navigation makes the following functions possible:
- Operation directly via touchscreen.
 - Freely definable operating levels within the performance curve values.
 - Choice between constant air flow volume or constant pressure regulation.
 - Demand-driven ventilation using CO₂-, VOC (mixed gas) or humidity sensor.
 - Central building control system via ModBus (RS 485).
 - Initial start-up (automatic determination of the system performance curve).
 - Control of external shutters.
 - Connection of a fire alarm contact.
 - Weekly or daily program.
 - Pressure monitoring of filter pollution.
 - Display of required filter change, operating state, error messages.
 - Different access levels.

■ Electrical connection

Easily accessible terminal box located on top of the casing. Isolator switch, lockable via padlock, for maintenance work can be operated from the top of the unit.

■ Heater battery

Type KWL EC Pro WW
The integrated water heater battery provides a comfortable and energy-efficient heating of the supply air. The target temperature simply is set at the controller. For the control of the water heater battery the use of the hydraulic unit WSH HE 24 V (0-10 V), accessories, is recommended.

■ Note

The fan design according to VDI 6022 requires the use of VDI 6022 compliant air filters. Therefore, the use of original replacement air filters (see following page) is obligatory.

KWL EC 800 S

Frequency	Hz	Total	125	250	500	1k	2k	4k	8k
L _{WA} Extract air		dB(A) 70	65	68	54	49	43	35	34
L _{WA} Supply air		dB(A) 78	76	73	67	63	63	55	55
L _{PA} Case breakout		dB(A) 54	50	50	42	42	41	31	25

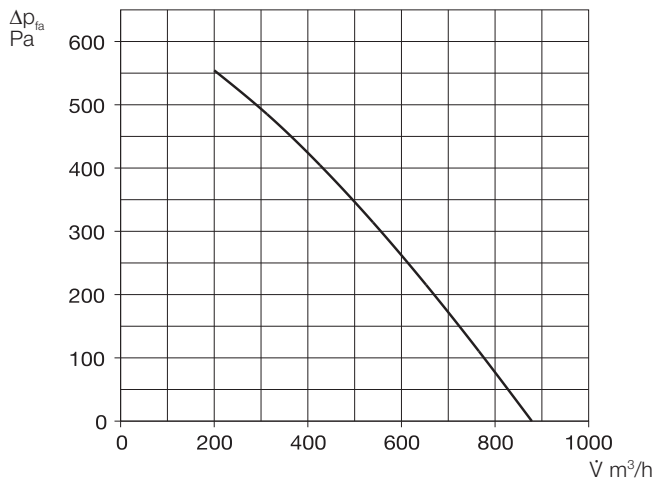

■ Included in delivery Comfort controller for surface mounting

User-friendly operation over self-describing graphic elements with plain text directly at the touch-screen. Control line SL 6/5 (length = 5 m) included in delivery, other lengths (SL 6/..., accessories) available for order.



■ Accessories for type Pro WW Hydraulic unit

Controls the flow of the water heater battery by means of three point valve actuator 24 V (0-10 V) and in this way the thermal output which is conveyed to the air. Delivery as complete unit, incl. flow-/return temp. display, circulation pump and flexible connecting pipes.

WHSB HE 24 V (0-10 V) No. 8318



■ Accessories for all types Room sensor

Measures CO₂-, mixed gas (VOC) concentration or relative humidity and controls the ventilation unit according to setpoint. Max. one sensor can be attached.

Dim. mm (W x H x D) 95 x 97 x 30

- Type KWL-CO₂ Ref. no. 4272
- Type KWL-FTF Ref. no. 4273
- Type KWL-VOC Ref. no. 4274



Adapter piece – symmetrical from rectangular unit flange to ducting.

Type KWL-ÜS 800 S No. 8339

Flexible sleeve

To reduce vibration transmission, incl. 2 worm drive clips.

Type FM 250 Ref. no. 1672

Flange ring from galvanised sheet steel for duct connection.

Type FR 250 Ref. no. 1203

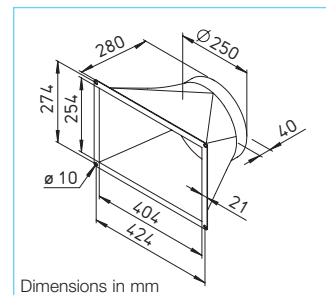

Dimensions in mm

Back draught shutter, motorised

Prevents inflow of cold air when unit stopped. Automatic operation when fan is in use. Comes with built-on spring release motor (installed outside the airflow). To be installed in any position. Closing pressure adjustable according to fan power and mounting position.

Type RVM 250 Ref. no. 2576



Base cover from galvanised sheet steel.

Type KWL-SB 800 S No. 9315

■ Replacement air filter

- 1 pc. M5-Filter (F5)
ELF-KWL 800 S/5 VDI No. 8256
- 1 pc. F7-Filter
ELF-KWL 800 S/7 VDI No. 8257

■ Other accessories Page

- KWL® periphery 114 on
- Air distribution systems 126 on
- Further overview, Control lines 136 on

Accessories-Details

- Grilles, ducting, fittings, bushings, 487 on
- extract air elements 136, 500 on

Technical data	KWL EC 800 S			KWL EC 800 S		
	Ref. no. 8327			Ref. no. 8328		
For ceiling installation	KWL EC 800 S Pro			KWL EC 800 S Pro WW		
Air flow volume on step¹⁾ Supply/extract air flow vol. \dot{V} m ³ /h approx.	③ 600	② 490	① 325	③ 600	② 490	① 325
Sound levels dB(A) at 620 m³/h and 195 Pa						
Supply air L _{WA} (sound power level)	78	ns	ns	78	ns	ns
Extract air L _{WA} (sound power level)	70	ns	ns	70	ns	ns
Case breakout L _{PA} in 1 m	54	ns	ns	54	ns	ns
Fan power 2 x W	140	94	65	140	94	65
Standby power consumption	< 1 W			< 1 W		
Voltage/Frequency	1 ~ 230 V, 50 Hz			1 ~ 230 V, 50 Hz		
Norm. cur. A – ventilation	2.5			2.5		
– pre-heater	11			11		
– max. total	13.5			13.5		
Electric pre-heater kW	2.5			2.5		
Heat power/heater battery kW	—			2.8 (at 60/40 °C) / 2.6 (at 50/40 °C) / 1.6 (at 40/30 °C)		
Summer Bypass	automatic (adjustable), with exchanger cover			automatic (adjustable), with exchanger cover		
Wiring diagram no.	1062			1062		
Temperature operation range	–20 °C to +40 °C			–20 °C to +40 °C		
Set-up temp.	+5 °C to +40 °C			+5 °C to +40 °C		
Connection PWW heater battery	—			IG 1/2"		
Weight approx. kg	172			175		

¹⁾ Figures relate to the operational range defined to PHI (Passive House Institute).

KWL EC 1200 S

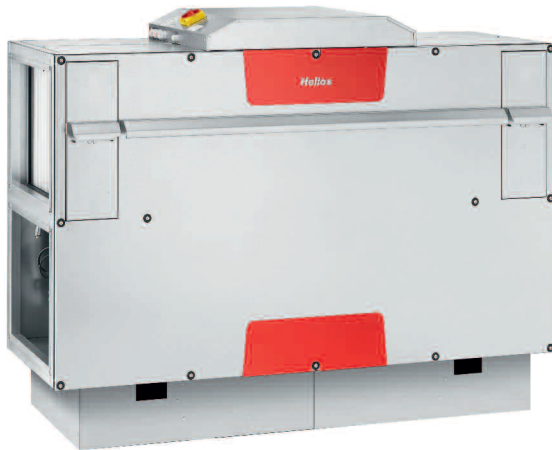

KWL EC 1200 S with base cover (Accessories)

KWL EC 1200 S

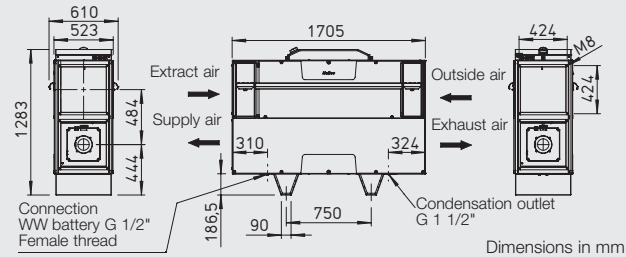

Central ventilation units with heat recovery for compact and space-saving floor installation (vertical). With wide range of application in apartments, commercial and industrial applications. Independently certified hygienic properties and energy efficiency according to VDI 6022 and passive house standard. Unit design and components meet the general hygienic requirements in VDI 6022. Integrated water heater battery optional.

■ Casing

Made from galvanised sheet steel. Heat and noise insulated with 30 mm thick mineral wool. Inspection openings for filter change at the two side doors which can be opened optionally without tool or using a socket wrench. Both sides panels are completely removable for free access of all elements. The unit is suitable for the vertical floor installation in the interior. Anti vibration mounts can be placed below (on site) to prevent the direct transmission of vibration and structure-borne noise on parts of the building.

■ Heat exchanger

Large surface cross counterflow heat exchanger from aluminium with an efficiency up to 90 %. Easy to remove.

■ Fans

Two silent highly efficient EC fans with backward curved impellers ensure highest efficiency. The special control system make a constant air flow volume or constant pressure regulation possible.

■ Ducting

Installation-friendly connection of the ducting for intake, exhaust, extract and supply air using ducts with nominal diameter of 355 mm. The unit can be installed either way round, so that intake- and exhaust air as well as extract- and supply air connections can be left or right.

■ Condensation outlet

The unit is equipped with a condensate tray made from high quality steel. The condensation outlet is located at the bottom. Ball siphon included in delivery. To be connected to drain pipe by installer.

■ Air filter

Standard equipment: Supply of cleaned outside air using a F7 filter. Extract air passes through a M5 filter before entering the heat exchanger. All filters are pressure monitored and are easy to remove.

■ Summer operation

Comes with automatic bypass function for maximum comfort as standard.

■ Frost protection of heat exchanger

An electric pre-heater battery heats the intake air when the temperature is too low. This prevents ice from building up in the heat exchanger and ensures optimal heat recovery during the complete heating period.

■ Speed control

- The comfort controller for surface mounting with touchscreen (included in delivery) and user-friendly menu navigation makes the following functions possible:
- Operation directly via touchscreen.
 - Freely definable operating levels within the performance curve values.
 - Choice between constant air flow volume or constant pressure regulation.
 - Demand-driven ventilation using CO₂-, VOC (mixed gas) or humidity sensor.
 - Central building control system via ModBus (RS 485).
 - Initial start-up (automatic determination of the system performance curve).
 - Control of external shutters.
 - Connection of a fire alarm contact.
 - Weekly or daily program.
 - Pressure monitoring of filter pollution.
 - Display of required filter change, operating state, error messages.
 - Different access levels.

■ Electrical connection

Easily accessible terminal box located on top of the casing. Isolator switch, lockable via padlock, for maintenance work can be operated from the top of the unit.

■ Heater battery

Type KWL EC Pro WW
The integrated water heater battery provides a comfortable and energy-efficient heating of the supply air. The target temperature simply is set at the controller. For the control of the water heater battery the use of the hydraulic unit WSHS HE 24 V (0-10 V), accessories, is recommended.

■ Note

The fan design according to VDI 6022 requires the use of VDI 6022 compliant air filters. Therefore, the use of original replacement air filters (see following page) is obligatory.

KWL EC 1200 S

Frequency	Hz	Total	125	250	500	1k	2k	4k	8k
L _{WA} Extract air	dB(A)	70	65	68	54	49	43	35	34
L _{WA} Supply air	dB(A)	78	76	73	67	63	63	55	55
L _{PA} Case breakout	dB(A)	54	50	50	42	42	41	31	25

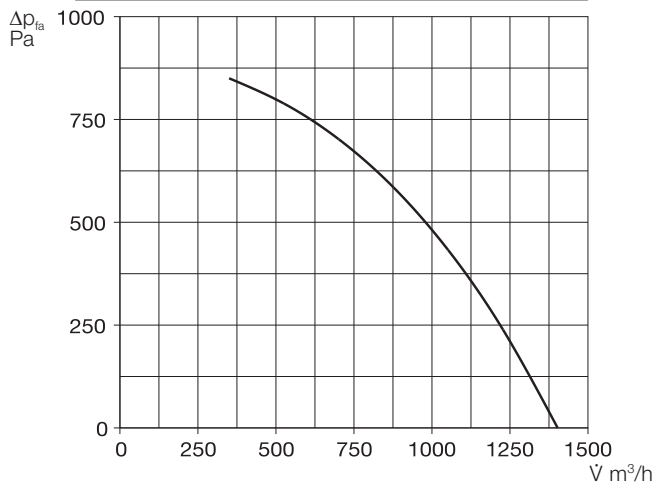

Included in delivery Comfort controller for surface mounting

User-friendly operation over self-describing graphic elements with plain text directly at the touch-screen. Control line SL 6/5 (length = 5 m) included in delivery, other lengths (SL 6/..., accessories) available for order.



Accessories for type Pro WW Hydraulic unit

Controls the flow of the water heater battery by means of three point valve actuator 24 V (0-10 V) and in this way the thermal output which is conveyed to the air. Delivery as complete unit, incl. flow-/return temp. display, circulation pump and flexible connecting pipes.

WHSHE 24 V (0-10 V) No. 8318



Accessories for all types

Room sensor

Measures CO₂-, mixed gas (VOC) concentration or relative humidity and controls the ventilation unit according to setpoint. Max. one sensor can be attached.

Dim. mm (W x H x D) 95 x 97 x 30

- Type KWL-CO₂ Ref. no. 4272
- Type KWL-FTF Ref. no. 4273
- Type KWL-VOC Ref. no. 4274



Adapter piece – symmetrical
from rectangular unit flange to ducting.

Type KWL-ÜS 1200 S No. 8349

Flexible sleeve

To reduce vibration transmission, incl. 2 worm drive clips.

Type FM 355 Ref. no. 1675

Flange ring from galvanised sheet steel for duct connection.

Type FR 355 Ref. no. 1205

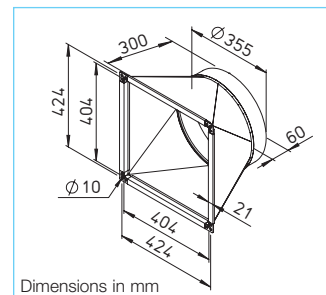

Back draught shutter, motorised

Prevents inflow of cold air when unit stopped. Automatic operation when fan is in use. Comes with built-on spring release motor (installed outside the airflow). To be installed in any position. Closing pressure adjustable according to fan power and mounting position.

Type RVM 355 Ref. no. 2579



Base cover
from galvanised sheet steel.

Type KWL-SB 1200 S No 9316

Replacement air filter

- 1 pc. M5-Filter (F5)
ELF-KWL 1200 S/5 VDI No. 8347
- 1 pc. F7-Filter
ELF-KWL 1200 S/7 VDI No. 8348

Other accessories Page

- KWL® periphery 114 on
- Air distribution systems 126 on
- Further overview, Control lines 136 on

Accessories-Details

- Grilles, ducting, fittings, bushings, 487 on
- extract air elements 136, 500 on

Technical data	KWL EC 1200 S		KWL EC 1200 S	
	Ref. no. 8345		Ref. no. 8346	
For ceiling installation	KWL EC 1200 S Pro		KWL EC 1200 S Pro WW	
Air flow volume on step¹⁾	②	①	②	①
Supply/extract air flow vol. \dot{V} m ³ /h approx.	1300	350	1300	350
Sound levels dB(A) at 1300 m³/h and 75 Pa				
Supply air L _{WA} (sound power level)	78	ns	78	ns
Extract air L _{WA} (sound power level)	70	ns	70	ns
Case breakout L _{PA} in 1 m	54	ns	54	ns
Fan power 2 x W	375	80	375	80
Standby power consumption	< 1 W		< 1 W	
Voltage/Frequency	3 N – 400 V, 50 Hz		3 N – 400 V, 50 Hz	
Norm. cur. A – ventilation	4,9		4,9	
– pre-heater	– / 14.2 / 14.2		– / 14.2 / 14.2	
– max. total	4.9 / 14.2 / 14.2		4.9 / 14.2 / 14.2	
Electric pre-heater kW	5.7		5.7	
Heat power/heater battery kW	—		2.8 (at 60/40 °C) / 2.6 (at 50/40 °C) / 1.6 (at 40/30 °C)	
Summer Bypass	automatic (adjustable), with exchanger cover		automatic (adjustable), with exchanger cover	
Wiring diagram no.	1092		1092	
Temperature operation range	–20 °C to +40 °C		–20 °C to +40 °C	
Set-up temp.	+5 °C to +40 °C		+5 °C to +40 °C	
Connection PWW heater battery	—		IG 1/2"	
Weight approx. kg	250		256	

¹⁾ Figures relate to the operational range defined to PHI (Passive House Institute).

KWL EC 1800 S

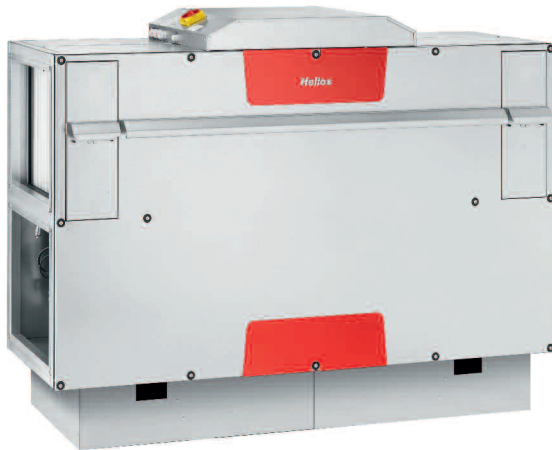

KWL EC 1800 S with base cover (Accessories)

KWL EC 1800 S

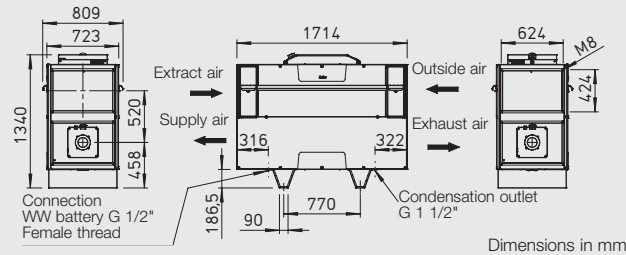

Central ventilation units with heat recovery for compact and space-saving floor installation (vertical). With wide range of application in apartments, commercial and industrial applications. Independently certified hygienic properties and energy efficiency according to VDI 6022 and passive house standard. Unit design and components meet the general hygienic requirements in VDI 6022. Integrated water heater battery optional.

■ Casing

Made from galvanised sheet steel. Heat and noise insulated with 30 mm thick mineral wool. Inspection openings for filter change at the two side doors which can be opened optionally without tool or using a socket wrench. Both sides panels are completely removable for free access of all elements. The unit is suitable for the vertical floor installation in the interior. Anti vibration mounts can be placed below (on site) to prevent the direct transmission of vibration and structure-borne noise on parts of the building.

■ Heat exchanger

Large surface cross counterflow heat exchanger from aluminium with an efficiency up to 90 %. Easy to remove.

■ Fans

Two silent highly efficient EC fans with backward curved impellers ensure highest efficiency. The special control system make a constant air flow volume or constant pressure regulation possible.

■ Ducting

Installation-friendly connection of the ducting for intake, exhaust, extract and supply air using ducts with nominal diameter of 400 mm. The unit can be installed either way round, so that intake- and exhaust air as well as extract- and supply air connections can be left or right.

■ Condensation outlet

The unit is equipped with a condensate tray made from high quality steel. The condensation outlet is located at the bottom. Ball siphon included in delivery. To be connected to drain pipe by installer.

■ Air filter

Standard equipment: Supply of cleaned outside air using a F7 filter. Extract air passes through a M5 filter before entering the heat exchanger. All filters are pressure monitored and are easy to remove.

■ Summer operation

Comes with automatic bypass function for maximum comfort as standard.

■ Frost protection of heat exchanger

An electric pre-heater battery heats the intake air when the temperature is too low. This prevents ice from building up in the heat exchanger and ensures optimal heat recovery during the complete heating period.

■ Speed control

- The comfort controller for surface mounting with touchscreen (included in delivery) and user-friendly menu navigation makes the following functions possible:
- Operation directly via touchscreen.
 - Freely definable operating levels within the performance curve values.
 - Choice between constant air flow volume or constant pressure regulation.
 - Demand-driven ventilation using CO₂-, VOC (mixed gas) or humidity sensor.
 - Central building control system via ModBus (RS 485).
 - Initial start-up (automatic determination of the system performance curve).
 - Control of external shutters.
 - Connection of a fire alarm contact.
 - Weekly or daily program.
 - Pressure monitoring of filter pollution.
 - Display of required filter change, operating state, error messages.
 - Different access levels.

■ Electrical connection

Easily accessible terminal box located on top of the casing. Isolator switch, lockable via padlock, for maintenance work can be operated from the top of the unit.

■ Heater battery

Type KWL EC Pro WW
The integrated water heater battery provides a comfortable and energy-efficient heating of the supply air. The target temperature simply is set at the controller. For the control of the water heater battery the use of the hydraulic unit WSHS HE 24 V (0-10 V), accessories, is recommended.

■ Note

The fan design according to VDI 6022 requires the use of VDI 6022 compliant air filters. Therefore, the use of original replacement air filters (see following page) is obligatory.

KWL EC 1800 S

Frequency	Hz	Total	125	250	500	1k	2k	4k	8k
L _{WA} Extract air	dB(A)	61	54	58	51	52	49	38	14
L _{WA} Supply air	dB(A)	72	61	66	63	65	64	56	56
L _{PA} Case breakout	dB(A)	52	35	47	43	47	47	37	28

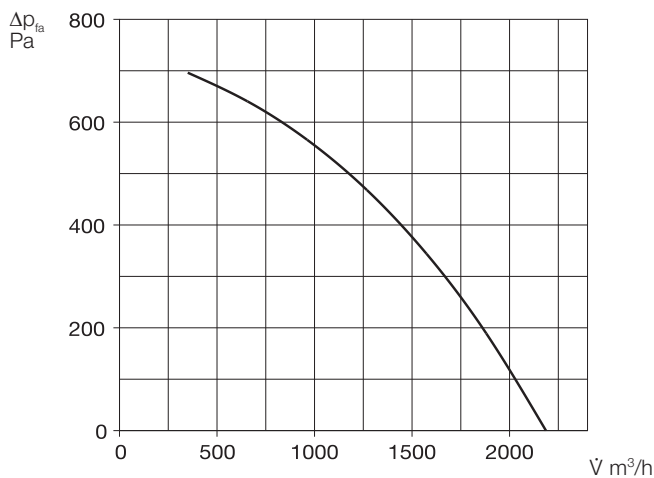

■ Included in delivery Comfort controller for surface mounting

User-friendly operation over self-describing graphic elements with plain text directly at the touch-screen. Control line SL 6/5 (length = 5 m) included in delivery, other lengths (SL 6/..., accessories) available for order.



■ Accessories for type Pro WW Hydraulic unit

Controls the flow of the water heater battery by means of three point valve actuator 24 V (0-10 V) and in this way the thermal output which is conveyed to the air. Delivery as complete unit, incl. flow-/return temp. display, circulation pump and flexible connecting pipes.

WHSHE 24 V (0-10 V) No. 8318



■ Accessories for all types Room sensor

Measures CO₂-, mixed gas (VOC) concentration or relative humidity and controls the ventilation unit according to setpoint. Max. one sensor can be attached.

Dim. mm (W x H x D) 95 x 97 x 30

- Type KWL-CO₂ Ref. no. 4272
- Type KWL-FTF Ref. no. 4273
- Type KWL-VOC Ref. no. 4274



Adapter piece – symmetrical from rectangular unit flange to ducting.

Type KWL-ÜS 1800 S No. 8340

Flexible sleeve

To reduce vibration transmission, incl. 2 worm drive clips.

Type FM 400 Ref. no. 1676

Flange ring from galvanised sheet steel for duct connection.

Type FR 400 Ref. no. 1206

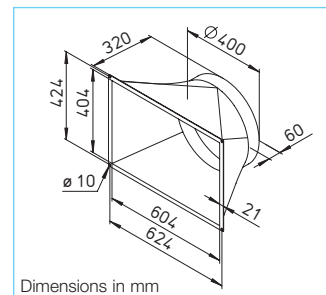

Dimensions in mm

Back draught shutter, motorised

Prevents inflow of cold air when unit stopped. Automatic operation when fan is in use. Comes with built-on spring release motor (installed outside the airflow). To be installed in any position. Closing pressure adjustable according to fan power and mounting position.

Type RVM 400 Ref. no. 2580



Base cover from galvanised sheet steel.

Type KWL-SB 1800 S No. 9317

■ Replacement air filter

- 1 pc. M5-Filter (F5)
ELF-KWL 1800 S/5 VDI No. 8258
- 1 pc. F7-Filter
ELF-KWL 1800 S/7 VDI No. 8259

■ Other accessories Page

- KWL® periphery 114 on
- Air distribution systems 126 on
- Further overview, Control lines 136 on

Accessories-Details

- Grilles, ducting, fittings, bushings, 487 on
- extract air elements 136, 500 on

Technical data	KWL EC 1800 S			KWL EC 1800 S		
	Ref. no. 8329			Ref. no. 8330		
For floor installation	KWL EC 1800 S Pro			KWL EC 1800 S Pro WW		
Air flow volume on step¹⁾ Supply/extract air flow vol. V m ³ /h approx.	③ 1400	② 1070	① 810	③ 1400	② 1070	① 810
Sound levels dB(A) at 1400 m³/h and 245 Pa						
Supply air L _{WA} (sound power level)	72	ns	ns	72	ns	ns
Extract air L _{WA} (sound power level)	61	ns	ns	61	ns	ns
Case breakout L _{PA} in 1 m	52	ns	ns	52	ns	ns
Fan power 2 x W	315	225	165	315	225	165
Standby power consumption	< 1 W			< 1 W		
Voltage/Frequency	3 N - 400 V, 50 Hz			3 N - 400 V, 50 Hz		
Norm. cur. A - ventilation	5,0 / - / -			5,0 / - / -		
- pre-heater	6,5 / 6,5 / 6,5			6,5 / 6,5 / 6,5		
- max. total	11,5 / 6,5 / 6,5			11,5 / 6,5 / 6,5		
Electric pre-heater kW	4,5			4,5		
Heat power/heater battery kW	—			5.2 (at 60/40 °C) / 4.9 (at 50/40 °C) / 3.0 (at 40/30 °C)		
Summer Bypass	automatic (adjustable), with exchanger cover			automatic (adjustable), with exchanger cover		
Wiring diagram no.	1063			1063		
Temperature operation range	-20 °C to +40 °C			-20 °C to +40 °C		
Set-up temp.	+5 °C to +40 °C			+5 °C to +40 °C		
Connection PWW heater battery	—			IG 1/2"		
Weight approx. kg	290			295		

¹⁾ Figures relate to the operational range defined to PHI (Passive House Institute).

KWL EC 2600 S



KWL EC 2600 S with base cover (Accessories)

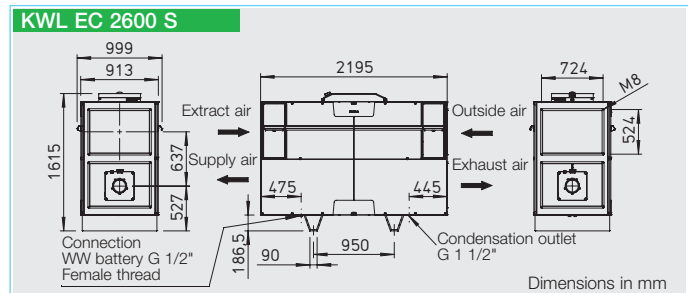

Central ventilation units with heat recovery for compact and space-saving floor installation (vertical). With wide range of application in apartments, commercial and industrial applications. Independently certified hygienic properties and energy efficiency according to VDI 6022 and passive house standard. Unit design and components meet the general hygienic requirements in VDI 6022. Integrated water heater battery optional.

■ **Casing**

Made from galvanised sheet steel. Heat and noise insulated with 30 mm thick mineral wool. Inspection openings for filter change at the two side doors which can be opened optionally without tool or using a socket wrench. Both sides panels are completely removable for free access of all elements. The unit is suitable for the vertical floor installation in the interior. Anti vibration mounts can be placed below (on site) to prevent the direct transmission of vibration and structure-borne noise on parts of the building.

■ **Heat exchanger**

Large surface cross counterflow heat exchanger from aluminium with an efficiency up to 90 %. Easy to remove.

■ **Fans**

Two silent highly efficient EC fans with backward curved impellers ensure highest efficiency. The special control system make a constant air flow volume or constant pressure regulation possible.

■ **Ducting**

Installation-friendly connection of the ducting for intake, exhaust, extract and supply air using ducts with nominal diameter of 560 mm. The unit can be installed either way round, so that intake- and exhaust air as well as extract- and supply air connections can be left or right.

■ **Condensation outlet**

The unit is equipped with a condensate tray made from high quality steel. The condensation outlet is located at the bottom. Ball siphon included in delivery. To be connected to drain pipe by installer.

■ **Air filter**

Standard equipment: Supply of cleaned outside air using a F7 filter. Extract air passes through a M5 filter before entering the heat exchanger. All filters are pressure monitored and are easy to remove.

■ **Summer operation**

Comes with automatic bypass function for maximum comfort as standard.

■ **Frost protection of heat exchanger**

An electric pre-heater battery heats the intake air when the temperature is too low. This prevents ice from building up in the heat exchanger and ensures optimal heat recovery during the complete heating period.

■ **Speed control**

- The comfort controller for surface mounting with touchscreen (included in delivery) and user-friendly menu navigation makes the following functions possible:
- Operation directly via touchscreen.
 - Freely definable operating levels within the performance curve values.
 - Choice between constant air flow volume or constant pressure regulation.
 - Demand-driven ventilation using CO₂-, VOC (mixed gas) or humidity sensor.
 - Central building control system via ModBus (RS 485).
 - Initial start-up (automatic determination of the system performance curve).
 - Control of external shutters.
 - Connection of a fire alarm contact.
 - Weekly or daily program.
 - Pressure monitoring of filter pollution.
 - Display of required filter change, operating state, error messages.
 - Different access levels.

■ **Electrical connection**

Easily accessible terminal box located on top of the casing. Isolator switch, lockable via padlock, for maintenance work can be operated from the top of the unit.

■ **Heater battery**

Type KWL EC Pro WW

The integrated water heater battery provides a comfortable and energy-efficient heating of the supply air. The target temperature simply is set at the controller. For the control of the water heater battery the use of the hydraulic unit WSHS HE 24 V (0-10 V), accessories, is recommended.

■ **Note**

The fan design according to VDI 6022 requires the use of VDI 6022 compliant air filters. Therefore, the use of original replacement air filters (see following page) is obligatory.

KWL EC 2600 S

Frequency	Hz	Total	125	250	500	1k	2k	4k	8k
L _{WA} Extract air	dB(A)	62	52	58	56	54	49	43	27
L _{WA} Supply air	dB(A)	77	67	69	72	67	60	51	
L _{PA} Case breakout	dB(A)	52	37	48	46	46	43	36	23

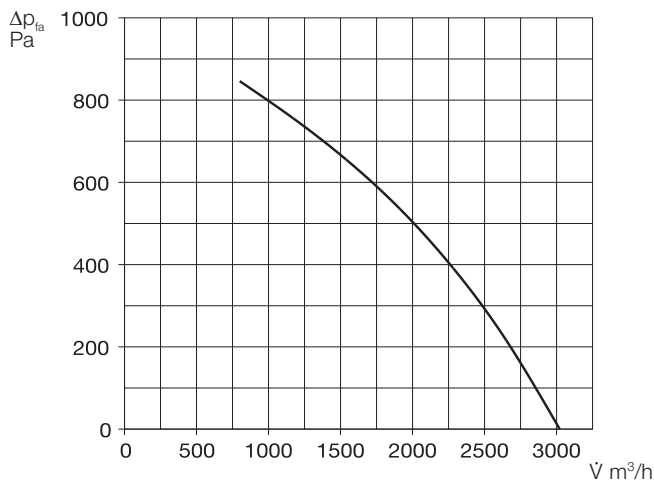

■ Included in delivery Comfort controller for surface mounting

User-friendly operation over self-describing graphic elements with plain text directly at the touch-screen. Control line SL 6/5 (length = 5 m) included in delivery, other lengths (SL 6/..., accessories) available for order.



■ Accessories for type Pro WW Hydraulic unit

Controls the flow of the water heater battery by means of three point valve actuator 24 V (0-10 V) and in this way the thermal output which is conveyed to the air. Delivery as complete unit, incl. flow-/return temp. display, circulation pump and flexible connecting pipes.

WHSB HE 24 V (0-10 V) No. 8318



■ Accessories for all types Room sensor

Measures CO₂-, mixed gas (VOC) concentration or relative humidity and controls the ventilation unit according to setpoint. Max. one sensor can be attached.

Dim. mm (W x H x D) 95 x 97 x 30

- Type KWL-CO₂ Ref. no. 4272
- Type KWL-FTF Ref. no. 4273
- Type KWL-VOC Ref. no. 4274



Adapter piece – symmetrical from rectangular unit flange to ducting.

Type KWL-ÜS 2600 S No. 8341

Flexible sleeve

To reduce vibration transmission, incl. 2 worm drive clips.

Type FM 560 Ref. no. 1679

Flange ring from galvanised sheet steel for duct connection.

Type FR 560 Ref. no. 1209

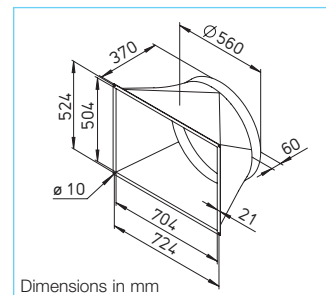

Back draught shutter, motorised

Prevents inflow of cold air when unit stopped. Automatic operation when fan is in use. Comes with built-on spring release motor (installed outside the airflow). To be installed in any position. Closing pressure adjustable according to fan power and mounting position.

Type RVM 560 Ref. no. 2583



Base cover from galvanised sheet steel.

Type KWL-SB 2600 S No. 9318

■ Replacement air filter

- 1 pc. M5-Filter (F5)
ELF-KWL 2600 S/5 VDI No. 8308
- 1 pc. F7-Filter
ELF-KWL 2600 S/7 VDI No. 8325

■ Other accessories Page

KWL® periphery	114 on
– Air distribution systems	126 on
– Further overview, Control lines	136 on

Accessories-Details

Grilles, ducting, fittings, bushings,	487 on
extract air elements	136, 500 on

Technical data	KWL EC 2600 S			KWL EC 2600 S		
	Ref. no. 8331			Ref. no. 8332		
For floor installation	KWL EC 2600 S Pro			KWL EC 2600 S Pro WW		
Air flow volume on step¹⁾	③	②	①	③	②	①
Supply/extract air flow vol. \dot{V} m ³ /h approx.	2065	1450	840	2065	1450	840
Sound levels dB(A) at 2100 m³/h and 275 Pa						
Supply air L _{WA} (sound power level)	77	ns	ns	77	ns	ns
Extract air L _{WA} (sound power level)	62	ns	ns	62	ns	ns
Case breakout L _{PA} in 1 m	52	ns	ns	52	ns	ns
Fan power 2 x W	450	295	175	450	295	175
Standby power consumption	< 1 W			< 1 W		
Voltage/Frequency	3 N - 400 V, 50 Hz			3 N - 400 V, 50 Hz		
Norm. cur. A – ventilation	2.5 / 2.5 / 2.5			2.5 / 2.5 / 2.5		
– pre-heater	10.0 / 10.0 / 10.0			10.0 / 10.0 / 10.0		
– max. total	12.5 / 12.5 / 12.5			12.5 / 12.5 / 12.5		
Electric pre-heater kW	6.9			6.9		
Heat power/heater battery kW	—			9.3 (at 60/40 °C) / 8.5 (at 50/40 °C) / 5.3 (at 40/30 °C)		
Summer Bypass	automatic (adjustable), with exchanger cover			automatic (adjustable), with exchanger cover		
Wiring diagram no.	1064			1064		
Temperature operation range	–20 °C to +40 °C			–20 °C to +40 °C		
Set-up temp.	+5 °C to +40 °C			+5 °C to +40 °C		
Connection PWW heater battery	—			IG 1/2"		
Weight approx. kg	490			500		

¹⁾ Figures relate to the operational range defined to PHI (Passive House Institute).

“All from a single source” for perfect KWL® system functionality.



Just as important as the KWL® ventilation unit is the suitable system-periphery in the building. Perfectly adapted accessories, air distribution systems for extract-, supply-, intake and exhaust air as well as underfloor heat exchanger ensure the trouble-free and energy-saving operation of the KWL® system.

The use of integrated overall solutions from a single source guarantees a smooth installation. The planning of complete KWL® system is carried out quickly and safely in the online software tool KWLeasyPlan.de. Inclusive automatic creation of bill of quantities and proof of the ventilation concept.



KWL® flexpipe^{plus} isopipe renopipe

HYGROBOX AND UNDERSOIL HEAT EXCHANGER



Optional ground-to-brine or ground-to-earth heat exchanger increases the efficiency of the ventilation units with heat recovery. This saves even more energy in the winter and reduces the outside air temperature in the summer.

As an active humidification unit, the HygroBox ensures a healthy indoor climate throughout the year and prevents expensive damage to furniture, floor surfaces, etc.

116^{on}

INSULATED DUCTING SYSTEM IsoPipe®



IsoPipe® is the practical alternative to the spiral duct installation with additional thermal insulation. Already completely insulated IsoPipe® is perfect for intake- and exhaust air ducting as well as for the supply- and extract air pipe in lofts, basements or cool areas.

The insulated ducting system prevents condensation build-up and saves assembly time enormously.

122^{on}

AIR DISTRIBUTION SYSTEMS FlexPipe®, RenoPipe etc.



For every type of installation the suitable solution. FlexPipe®*plus* combines the proven round pipe concept with oval components. In any form, for even more flexibility in planning and installation.

RenoPipe is the perfect solution for the energetic renovation and is simply installed surface mounted to ceiling or wall.

There are also flat duct systems made of galvanised sheet steel or plastic available in flat construction and rigid construction.

126^{on}

ACCESSORIES



Multiple award-winning design valves, which unobtrusively integrate themselves into every room ambiance. Extract air elements, valves and overflow elements. Most diverse shutters, attenuators, air temperature control systems, heater batteries etc.

Versatile accessories complete the overall system solution from Helios in the range of central ventilation with heat recovery in a perfect way and guarantees the perfect functioning of the entire system.

136^{on}



KWL HB ..



KWL HB .. WW L



Especially developed for ventilation systems in residential buildings and offices. The Helios HygroBox, designed to achieve automatically a healthy climate with ideal humidity throughout the year.

Advantages

- Constant room climate with ideal humidity level.
- Avoidance of expensive damage to furniture, wooden floor surfaces and antiques.
- Relief of allergy complaints and physical loads. Strengthening of the body's defences by a shortening of the life span of bacteria and viruses.
- Reduction of fine dust and electrostatic loadings.

Special HygroBox characteristics

- Constant supply air humidity and temperature in all rooms.
- Principle of the natural evaporation prevents excessive humidity.
- Hygienic harmless by UVC disinfection.
- Fully automatic mode with automatic summer switch-off.
- Low-maintenance and easy installable.
- Low operating cost by use of the evaporation energy from the existing heating system.

Functional principle

The HygroBox is an active humidification unit for the integration into new or existing KWL® ventilation systems with heat recovery. The fresh outside air is fed through the heat exchanger of the KWL® unit and takes up the heat energy from the extracted air. The preheated air is supplied afterwards to the HygroBox, in which an active and automatic humidification

takes place according to the natural evaporation principle. A rotor fitted with lamellas turns inside the unit continuously in a water bath and passes water molecules over the moistened lamella surface on to the warmed supply air. Regardless of the operating level of the KWL® system as well as of outside influences of the weather the HygroBox keeps the preselected relative air humidity consistently and provides in such a way for a healthy climate with ideal humidity level.

Delivery

Compact unit, ready to plug in, including water hose and water filter

Heater battery

- The HygroBox is equipped with a water (type WW) or electric heater battery (type EH). The supply air is warmed up before humidification and provides in such a way for the required evaporation energy and pleasant temperature of the supply air.
- With heating systems with low flow water temperature (e.g., warm pumps) a low temperature heater battery (KWL-NHR, accessories, see on the right) is to be connected at the outlet side of the HygroBox.

Summer operation

- With sufficiently high humidity level of the outside air (e.g. in the summer) the HygroBox switches automatically into the standby mode. In this condition no water is in the unit and the rotor stands still.

KWL HB 250 .. L

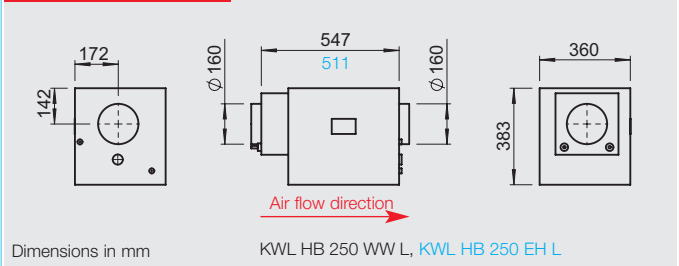

KWL HB 500 WW L

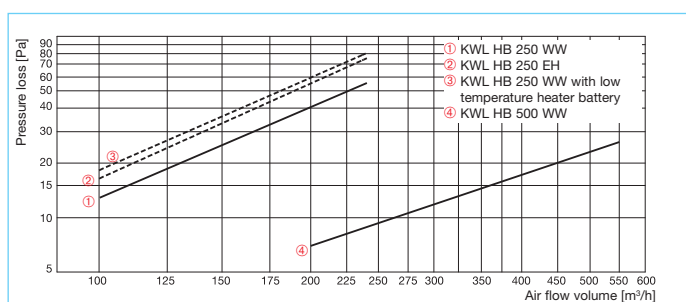
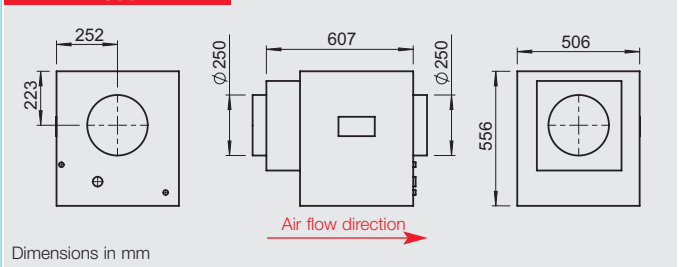

Assembly scheme KWL HB .. WW R

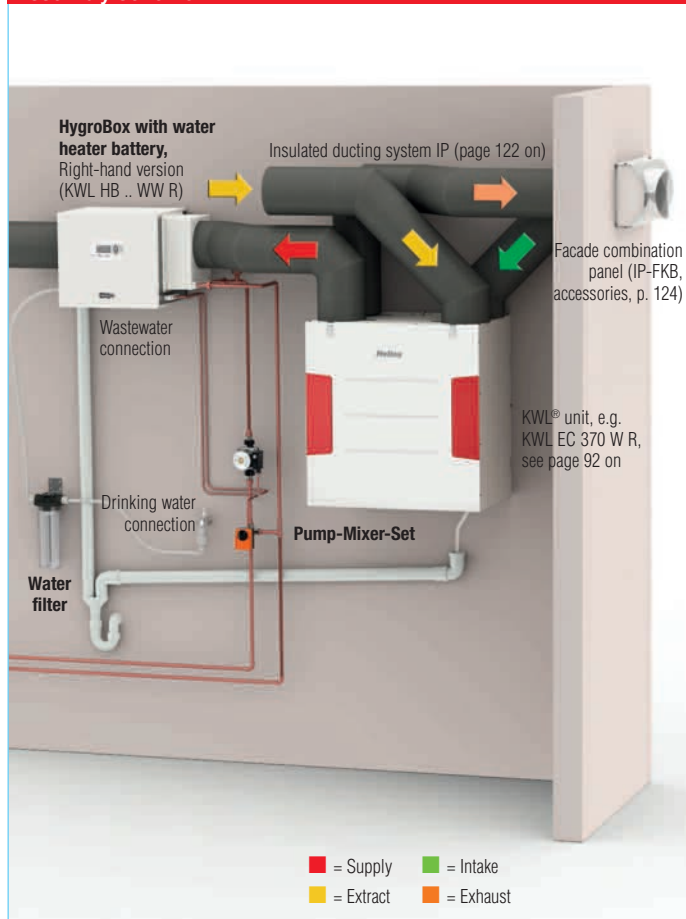

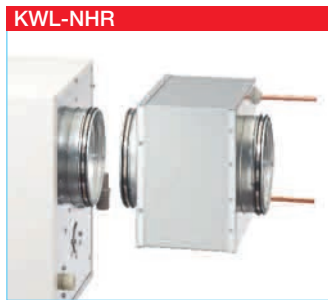

KWL-NHR
Low temperature heater battery
(for KWL HB .. WW)

■ **Description**

□ In connection with low-temperature heater batteries the additional installation of a heater battery at the air outlet of the HygroBox is recommended in order to compensate the evaporation cooling.

□ The external temperature sensor of the heater battery (included in delivery) is to be installed in a distance of approx. 50 cm after the heater battery in the supply air duct.

■ **Accessories**

Low temperature heater battery

- for KWL HB 250 WW
Type KWL-NHR 250 No. 5628
- for KWL HB 500 WW
Type KWL-NHR 500 No. 5633



KWL-PMA
Pump-Mixer-Set
(for KWL HB .. WW)

■ **Description**

□ For connection of HygroBox to existing heating circuits.
□ Consisting of:
– 1 pc. circulation pump 230 V
– 2 pcs. screw joints, R 1/2a/15 mm MS (brass)
– 1 pc. three-way-mixing valve with servo motor 230 V, Rp1/2", DN 15, operating time 120 seconds.

■ **Accessories**

Pump-Mixer-Set

- for KWL HB 250 WW
Type KWL-PMA 250 No. 5629
- for KWL HB 500 WW
Type KWL-PMA 500 No. 5634



KWL-UVR, KWL-OME
Spare-UVC-tube and -osmosis-membrane
(for all types)

■ **Description**

□ Helios HygroBox units are equipped with a continuous, automatically monitored UVC disinfection, which kills effectively all germs and bacteria.
□ Additionally, the water in the evaporator tub is changed automatically dependent on water hardness and evaporation performance.
□ A reverse osmosis system protects the unit against calcification.
□ The hygienic safety of the HygroBox is documented through an expert opinion and certified.

■ **Accessories**

- Spare-UVC-tube
Type KWL-UVR Ref. no. 5631
- Spare osmosis membrane
Type KWL-OME Ref. no. 5632



KWL-WF
Spare water filter
(for all types)

□ The water filter in water supply line is to be exchanged generally every 6 months. The filter change is indicated by a suitable note on the display of the HygroBox.

■ **Accessories**

- Spare water filter
Type KWL-WF Ref. no. 5630

Technical data						
	With electric heater battery For KWL® units up to 250 m³/h		With water heater battery For KWL® units up to 250 m³/h		For KWL® units up to 500 m³/h	
	Type	Ref. no.	Type	Ref. no.	Type	Ref. no.
Right-hand version (air intake on the right)	KWL HB 250 EH R	0963	KWL HB 250 WW R	0923	KWL HB 500 WW R	0981
Left-hand version (air intake on the left)	KWL HB 250 EH L	0962	KWL HB 250 WW L	0922	KWL HB 500 WW L	0980
Adjustable relative supply air humidity in %	40-60		40-60		40-60	
Adjustable supply air temperature °C	15-25		15-25		15-25	
Air flow volume m³/h	250		250		500	
Power consumption max. W	1400		100		100	
Heat power W	1300		2000		4200	
Voltage/Frequency	230 V ~, 50 Hz		230 V ~, 50 Hz		230 V ~, 50 Hz	
Water connection	3/4"		3/4"		3/4"	
Water drain Ø mm	40-50		40-50		40-50	
Weight (net weight/operating weight) approx. kg	25/28		25/28		46/61	
Accessories						
Pump-Mixer-Set	—	—	KWL-PMA 250	5629	KWL-PMA 500	5634
Ref. no.	—	—	KWL-NHR 250	5628	KWL-NHR 500	5633
Low temperature heater battery	—	—	KWL-UVR	5631	KWL-UVR	5631
Ref. no.	—	—	KWL-WF	5630	KWL-WF	5630
UVC-tube	KWL-UVR	5631	KWL-OME	5632	KWL-OME	5632
Ref. no.	KWL-UVR	5631	KWL-WF	5630	KWL-WF	5630
Water filter	KWL-WF	5630	KWL-OME	5632	KWL-OME	5632
Ref. no.	KWL-WF	5630	KWL-OME	5632	KWL-OME	5632
Osmosis membrane	KWL-OME	5632				
Ref. no.	KWL-OME	5632				

SEWT kit



The ground-to brine heat exchanger substantially increases the efficiency of the ventilation units. SEWT saves even more energy and reduces costs of heating to a minimum. The optimal add-on for ventilation systems with heat recovery.

Advantages

- Provides additional pre-heating and prevents icing during winter.
- Pleasant "natural cooling" on hot days.
- Comes as a complete kit with perfectly fitting components.

Operation

SEWT uses the fact that the temperature below the ground is relatively constant over the year. The undersoil collector hose is laid 1.2 m deep. The hydraulic unit circulates the brine-liquid according to the temperature outside. The brine liquid serves as heat transfer medium and delivers the heat to the supply air via the heat exchanger unit.

Effects:

- During winter
SEWT achieves a pre-heating of the cool outside air up to 14 K. This results in the intake air flowing into the ventilation unit with usually more than 0 °C and therefore prevents the heat exchanger from icing up. The benefits are a higher heat recovery factor and a higher supply air temperature. An additional heater battery is only needed on extremely cold days.
- On hot summer days
the SEWT reduces the outside air temperature.
- During transition periods
the circulation of the brine-liquid is provided by the hydraulic unit as a function of the outside temperature. Therefore the outside air always arrives at the ventilation unit energetically optimised. Saving energy and always provides comfortable room climate.

Information on planning

- To ensure the highest possible heat transfer, the undersoil collector hose should be laid in at least 1.2 m depth as there is a constant temperature of about 8-12 °C throughout the year. The soil temperature increases the deeper the ducts are laid and becomes constant.
- To increase the heat exchange the hose should be laid directly under the soil in a sandbed. Furthermore, a minimum space of 0.5 m from one hose to the other should be observed for two parallel tubes.
- Alternatively to laying the hose horizontally in a zigzag arrangement under the soil a vertical bore hole can be used.

Delivery

- According to the installation order on the building site and to ensure an optimised transport the SEWT is delivered as kit. The SEWT-kit ensures full functionality and perfect fitting accuracy. It consists of three delivery-sets as described on the right page.

SEWT kit **Ref. no. 2564**

Basic scheme for the installation

The ducting should be done with IsoPipe® to avoid condensation creation. Additionally insulated spiral ducting can be used alternatively.

Installation scheme

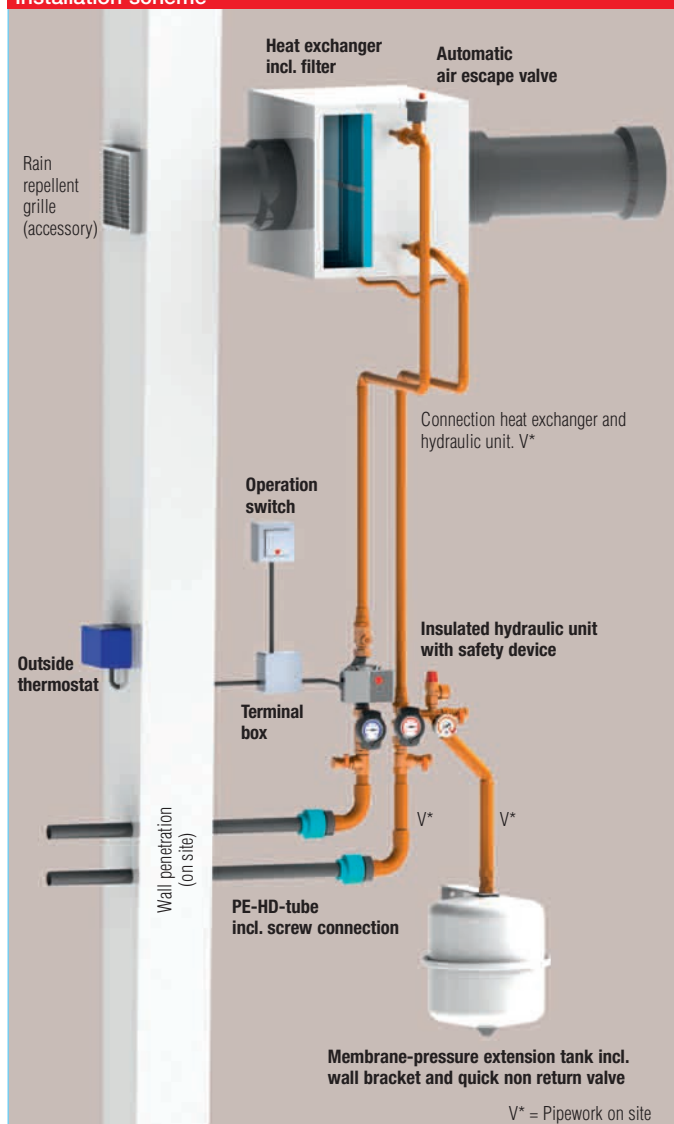

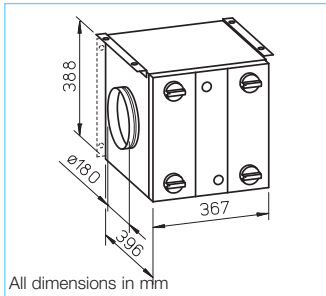

Brine-to-air heat exchanger

■ Specification

- Highly efficient brine-to-air heat exchanger with fins made from aluminium to ensure the best transfer to the intake air. Connection pipes made of copper Ø 12 mm.
- Double walled, completely insulated casing (20 mm insulation) made of steel, powder coated in grey. With mounting brackets for wall- and ceiling installation.
- Ø 180 mm spigots with twin-seal rubber gaskets.
- Variable air flow direction due to convertible air filter.
- With integrated G 3 filter. Prevents dust, insects etc. from accessing the duct system.
- Easy accessible panel can be opened without tools and allows simple access to the filter.
- Condensation outlet incl. condensation trap, Ø 1/2".

■ Accessories

Replacement air filters
(SU = 3 pcs.)

Type **ELF-SEWT-F** No. 2568

Technical data SEWT-W

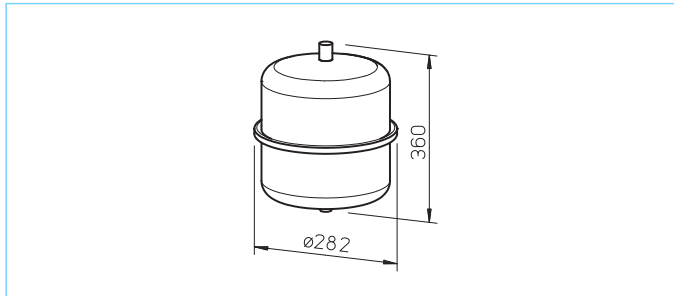
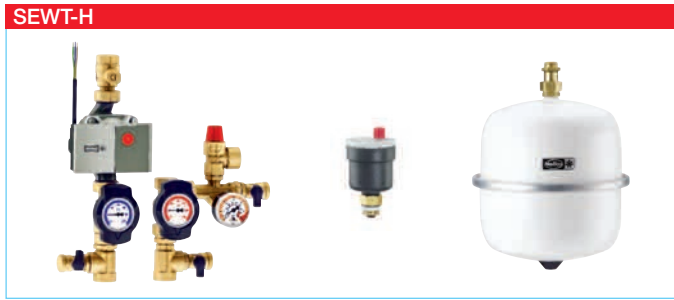
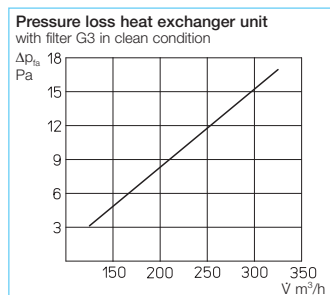

Hydraulic unit and control unit

■ Specification

- Complete hydraulic-set with all components needed to connect the brine-to-air heat exchanger unit. Delivered as standard with control unit for automatic and manual operation.

■ Delivery

- Brine-pump unit (230 V), incl. safety device.
- Temperature gauges for flow and return.
- Automatic protection against reverse flow.
- Pressure expansion tank – 12 litres, connection 3/4", incl. wall bracket and stop valve for maintenance.

- Thermostat module with 2 set-points for automatic control of the closed brine loop in summer/winter operation.
- Control unit to change from automatic (thermostat operation) a manual operation of the closed brine loop (incl. separate terminal box – without figure).



Technical data thermostat

Current	16 A (4 A ind.)
Voltage	230 V, 50/60 Hz
Protection to	IP 54
Wiring diagram no.	906
Temp. range (adjustable)	2 x 0 – 40 °C

Technical data hydraulic module

Current max.	0,44 A
Voltage	230 V, 50 Hz
Power consumption	3 – 45 W
Protection to	IP 44

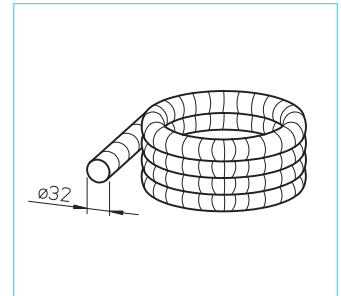

Undersoil hose set with screw connections and 20 l ethylene glycol.

■ Specification

- Flexible PE-HD undersoil hose (PE-HD = polyethylene high pressure hose), wall thickness 2.9 mm, outer-Ø 32 mm. Delivered as bundle with 100 running mtrs.
- Especially designed for undersoil laying.
- Screw connection set made from high class polymer (PP) to connect the undersoil hose to the hydraulic unit.
- Screw connection set (32-1") with active sealing system.
- 20 l canister with ethylene glycol, free of amine and nitrite. Adequate for one complete filling of the system with a 25 % glycol-water mix.

■ Note

The SEWT-kit with the advantage of the package price ensures full functionality and perfect fitting accuracy:

Type **SEWT kit** Ref. no. 2564

The single parts of the SEWT-kit can also be ordered separately:

Type **SEWT-W** Ref. no. 2565
SEWT-H Ref. no. 2566
SEWT-E Ref. no. 2567

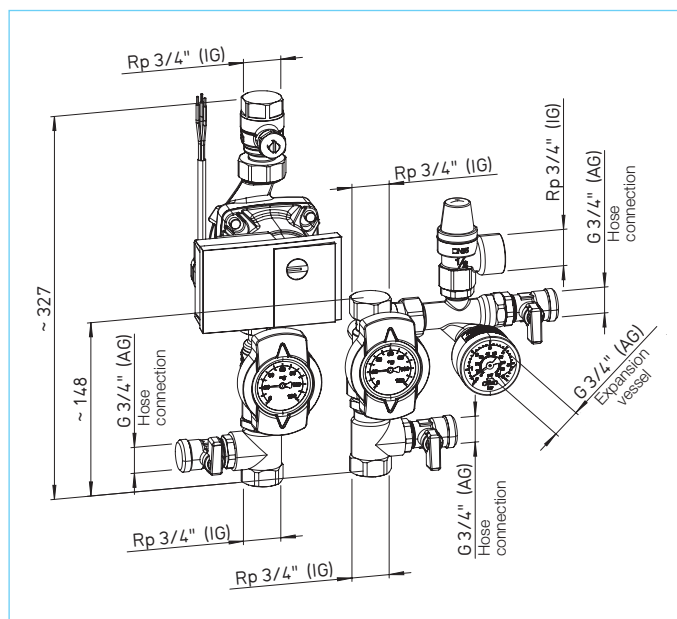



The undersoil air heat exchanger LEWT substantially increases the efficiency of the ventilation units with heat recovery.

Advantages

- Provides additional pre-heating during winter without any further energy requirements.
- Prevents the heat exchanger from icing up.
- Pleasant cooling on hot days.
- Additional heating of the supply air is only necessary when outside temperature is very low.
- Comes as a complete kit with perfectly fitting components.

Functional principle

LEWT uses the fact that the temperature below the ground is relatively constant all year. The outside air is not taken in directly but passes through the undersoil collector duct installed in approx. 1.2 to 1.5 m deep; the total length should be at least 40 m.

Effects:

- During winter achieves a pre-heating of the cool outside air up to 14 K. This results in the intake air flowing into the ventilation unit at more than 0 °C usually and therefore prevents the heat exchanger from icing up. The benefits are a higher heat recovery factor and a higher supply air temperature. The heater battery is only needed on very cold days.
- On hot summer days the LEWT reduces the outside air temperature.
- During transition periods the intake is by either the air passing through the undersoil collector or the direct intake opening depending on the outside temperature detected by the sensor. The electric bypass shutter controls the air intake automatically. The outside air

reaches the ventilation unit energetically optimised which additionally saves energy and provides a comfortable climate within the rooms.

Delivery

- According to the installation order on the building site and to ensure an optimised transport the LEWT is delivered as a kit. It consists of three delivery sets as described on the right hand page.
- The single components perfectly fit together as a sophisticated system. This ensures easy, quick and precise mounting with a high installation reliability.

Information on planning

- To ensure the highest possible heat transfer, the undersoil air collector duct should be laid in at least 1.2 m depth as there is a constant temperature of about 8 °C throughout the year. The soil temperature increases the deeper the ducts are laid and becomes constant.
- When installing it is important to consider that the condensation drain requires an incline of at least 2 %.
- To increase the heat exchange the duct should be laid directly under the soil in a sandbed. Furthermore, a space of 1 m from one duct to the other should be maintained when laying two ducts parallel.
- To keep the downstream pressure loss minimised a bending radius of at least 1 m is recommended.

LEWT kit Ref. no. 2977

Basic scheme for the laying: Buildings with basements

The undersoil collector reaches the building subsurface through a wall penetration.

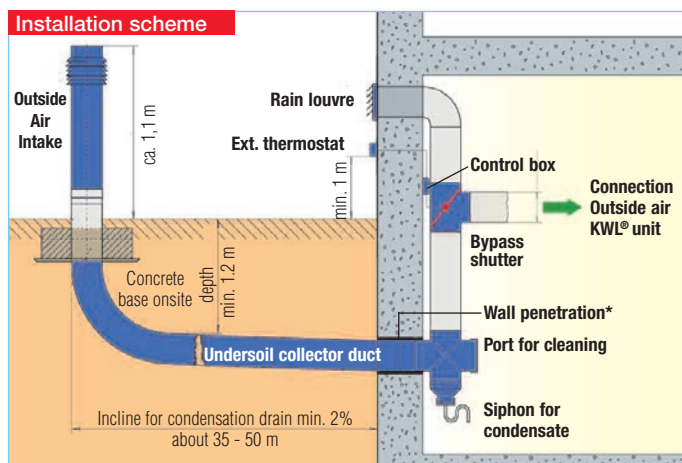

* not suitable for water pressure

Basic scheme for the laying: Buildings without basements

Undersoil collector reaches the building subsurface through the base plate. For revision purposes a drain is required by customer.

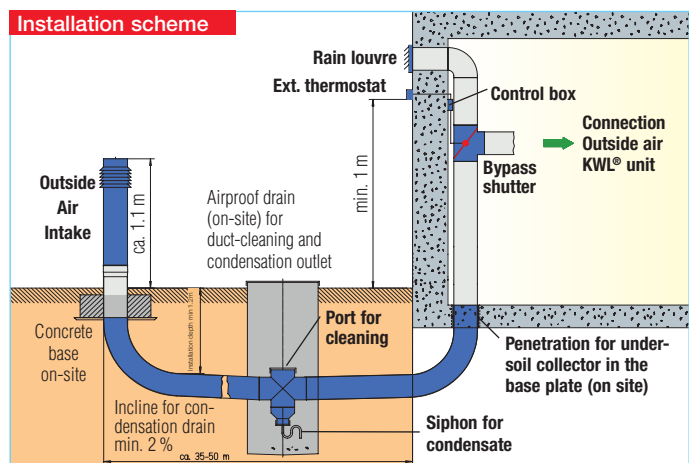

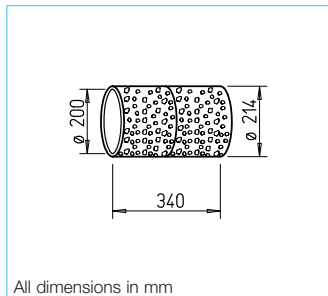

All dimensions in mm

Undersoil collector duct and wall penetration LEWT-E+M

- Description**
- Flexible undersoil collector duct, ribbed on the outside, smooth inner surface to ensure a very low air resistance, \varnothing 200 mm.
- Co-extruded compound duct made from physiological and toxicological harmless polyethylene (PE-HD). Developed specifically for undersoil laying.
- Easy to clean, complies with DIN 1946-6 (VDI 6022).
- 100 % odourless, 1a quality-assured PE-HD exclude transmission of pollutants and evaporations.
- The material PE-HD achieves a 2-times higher conductivity than PP with comparable wall thicknesses / duct cross sections. Even at 2.5 x better heat conduction performance a rises compared to PVC.
- Supplied as set with 2 x 25 running meters including wall duct DN 200 from polyethylene (bonding surface), profile seals, connector and seals.
- Undersoil collector, wall penetration and seals comply with IP 67, assuming accurate installation.

Additional connector with 2 seals.
LEWT-MU Ref. no. 2971

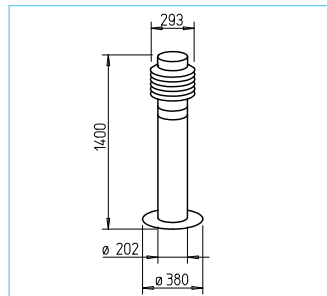

Outside-air-intake LEWT-A with filter

- Description**
- Outside-air-intake in modern and timeless stainless-steel design.
- The connection between the outside-air-intake and undersoil duct is done by just clipping.
- Fixation with support or bordering plate in dry construction or by setting in concrete.
- All parts are made of stainless steel.
- With integrated cone air filter, class G3. Prevents dust and insects from accessing the duct system.
- Cone filter can easily be released by hand for cleaning and changing.

Accessories
Replacement air filter (SU = 3 pcs.)
ELF-LEWT-A Ref. no. 2975

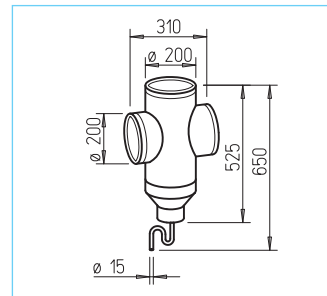
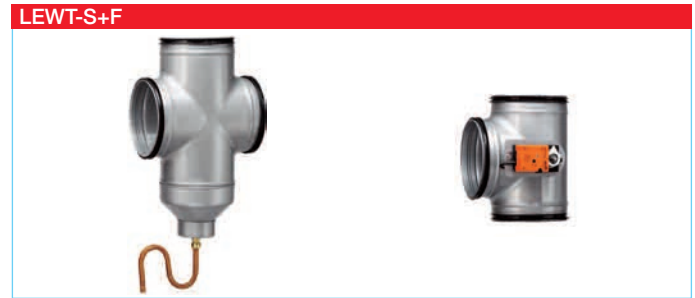
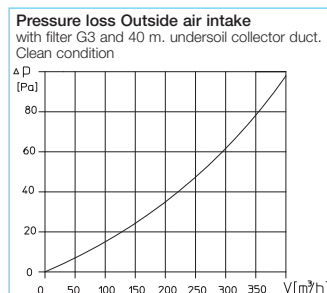

Controller and duct form parts LEWT-S+

- Description**
- Automatic controlling of the outside air intake via the undersoil collector duct or directly via the outside area as per the detected outside temperature.
- Temperature range for direct intake can be adjusted individually.
- Manual selection of the operation mode is possible.
- Delivery**
- Bypass shutter NW 200 with servo motor 230 V; for vertical mounting above the cross piece.
- Cross piece for connection with the wall penetration. Including port for cleaning, condensation collector, siphon and cover.
- Rain enclosure RAG (without pic.) suitable as coverage of the direct air intake. Prevents rain and insects from entering.

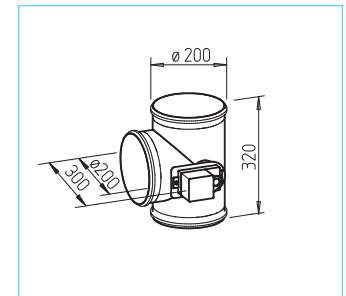

- Control knob and thermostat for automatic and manual control of the bypass shutter. To be mounted in a weather-protected place on the north-side of the building at 1 m height. Dimensions in mm W 200 x H 90 x D 70



- Control box with double switch. Modes:
 - Thermostat mode, automatic
 - Undersoil heat, manual
 - Outside air, manual
 Dimensions in mm W 110 x H 180 x D 100



Technical data thermostat

Current	16 A (4 A ind.)
Voltage	230 V, 50/60 Hz
Protection to	IP 54
Wiring diagram no.	798.1
Temp. range (adjustable)	2 x 0 – 40 °C

Technical data servo motor

Voltage	230 V, 50/60 Hz
Power	1.5 W
Protection to	IP 54

Note

The single parts of the LEWT-kit can also be ordered separately:

Type	Ref. no.
LEWT-E+M	2991
LEWT-S+F	2990
LEWT-A	2992

Insulated ducting system IsoPipe®



The innovative alternative to spiral ducting that must be insulated additionally to avoid condensation.

The insulated duct system IsoPipe®

- avoids condensation build-up,
- is provided with a smooth, sound absorbing inner surface and is easy to clean,
- saves assembly time,
- is the perfect solution for intake and extract ducting.

Laying

- All IsoPipe® parts, bends, wall and roof outlets are designed to fit together perfectly and fit into each other easily.
- IsoPipe® is mounted quickly: It saves up to 70% assembly time compared to a spiral ducting installation with additional insulation.

Specification

All parts are completely insulated and are made of water-vapour-tight and antistatic EPE. Heavy inflammable to class B1. Suitable for air flow temperatures from -25 to +80 °C. $\lambda = 0.04 \text{ W/mK}$, $d = 16 \text{ mm}$.

Laying-conception and installation

- IsoPipe® is especially applicable for intake and exhaust ducting in basements and the cold surroundings of a KWL® unit.
- Suitable for air flow volumes up to 500 m³/h .
- IsoPipe® is impact resistant, very lightweight and can easily be shortened to the required length with a knife.

IsoPipe® duct

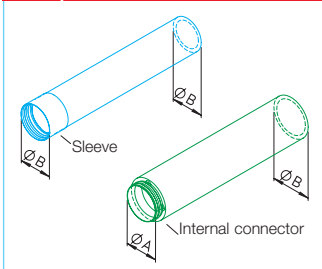

IsoPipe®	Ø 125 mm				Ø 160 mm				Ø 180 mm			
	Type	Ref. no.	Dim. in mm		Type	Ref. no.	Dim. in mm		Type	Ref. no.	Dim. in mm	
Duct with socket	IP 125/2000 ¹⁾	9406	—	157	—	—	—	—	—	—	—	—
Duct with inside connector	—	—	—	—	IP 160/2000 ²⁾	9447	160	192	IP 180/2000 ³⁾	9448	180	212

¹⁾ SU = 8 x 2 m ²⁾ SU = 6 x 2 m ³⁾ SU = 4 x 2 m

Socket / Inside connector

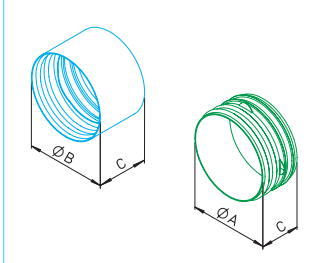

IsoPipe®	Ø 125 mm					Ø 160 mm					Ø 180 mm				
	Type	Ref. no.	Dim. in mm			Type	Ref. no.	Dim. in mm			Type	Ref. no.	Dim. in mm		
Socket	IP-MU 125	9394	—	157	104	—	—	—	—	—	—	—	—	—	
Inside connector	—	—	—	—	—	IP-IV 160	9453	160	—	80	IP-IV 180	9454	180	—	80

From polymers.

Elbow 45°

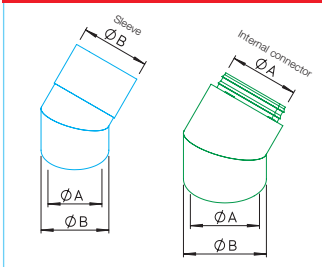

IsoPipe®	Ø 125 mm				Ø 160 mm				Ø 180 mm			
	Type	Ref. no.	Dim. in mm		Type	Ref. no.	Dim. in mm		Type	Ref. no.	Dim. in mm	
Elbow 45° with socket	IP-B 125/45	9399	125	157	—	—	—	—	—	—	—	—
Elbow 45° w. inside connector	—	—	—	—	IP-B 160/45	9449	160	192	IP-B 180/45	9450	180	212

Elbow 90°

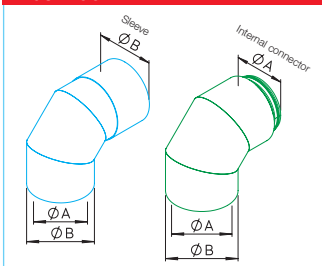

IsoPipe®	Ø 125 mm				Ø 160 mm				Ø 180 mm			
	Type	Ref. No.	Dim. in mm		Type	Ref. No.	Dim. in mm		Type	Ref. No.	Dim. in mm	
Elbow 90° with socket	IP-B 125/90	9398	125	157	—	—	—	—	—	—	—	—
Elbow 90° w. inside connector	—	—	—	—	IP-B 160/90	9451	160	192	IP-B 180/90	9452	180	212

Sticky tape / Casing clamp

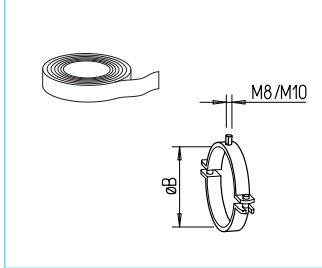

IsoPipe®	Ø 125 mm			Ø 160 mm			Ø 180 mm		
	Type	Ref. no.	Dim. in mm Ø B	Type	Ref. no.	Dim. in mm Ø B	Type	Ref. no.	Dim. in mm Ø B
Sticky tape insulated, 50 x 3 mm, 15 m	IP-KLB	9643		IP-KLB	9643		IP-KLB	9643	
Casing clamp	IP-S 125	9395	157	IP-S 160	9392	192	IP-S 180	9421	212

Duct piece to unit connection

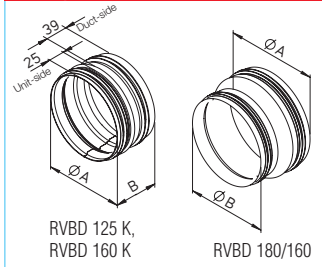

IsoPipe®	Ø 125 mm			Ø 160 mm			Ø 180 mm		
	Type	Ref. no.	Dim. in mm Ø A Ø B	Type	Ref. no.	Dim. in mm Ø A Ø B	Type	Ref. no.	Dim. in mm Ø A Ø B
Connector with seal to connect to KWL® unit									
– with socket DN 125	RVBD 125 K	3414	125 70	—	—		—	—	
– with socket DN 160	—	—		RVBD 160 K	3415	160 70	RVBD 180/160	9589	180 160

All duct pieces made from galvanised steel.

Duct piece to distribution box

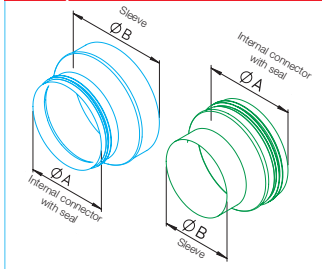

IsoPipe®	Ø 125 mm			Ø 160 mm			Ø 180 mm		
	Type	Ref. no.	Dim. in mm Ø A Ø B	Type	Ref. no.	Dim. in mm Ø A Ø B	Type	Ref. no.	Dim. in mm Ø A Ø B
Duct piece to connect to distribution box									
– with spigot DN 125	Direct duct connection			IP-ARZ 125/160	9458	160 125	—	—	
– with spigot DN 160	IP-ARZ 160/125	9358	125 160	Direct duct connection			IP-ARZ 160/180	9459	180 160
– with spigot DN 180	IP-ARZ 180/125	9360	125 180	IP-ARZ 180/160	9455	160 180	Direct duct connection		

All duct pieces made from galvanised steel.

Duct piece for KWL® HygroBox and underoil heat exchanger

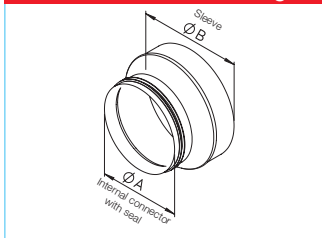

IsoPipe®	Ø 125 mm			Ø 160 mm			Ø 180 mm		
	Type	Ref. no.	Dim. in mm Ø A Ø B	Type	Ref. no.	Dim. in mm Ø A Ø B	Type	Ref. no.	Dim. in mm Ø A Ø B
Duct piece to connect to KWL® HygroBox									
– KWL HB 250, spigot DN 160	IP-ARZ 160/125	9358	125 160	Direct duct connection			—	—	
– KWL HB 500, spigot DN 250	—	—		IP-ARZ 250/160	9590	160 250	IP-ARZ 250/180	9591	180 250
to underoil heat exch.									
– LEWT, spigot DN 200	IP-ARZ 200/125	9359	125 200	IP-ARZ 200/160	9456	160 200	IP-ARZ 200/180	9457	180 200
– SEWT, spigot DN 180	IP-ARZ 180/125	9360	125 180	IP-ARZ 180/160	9455	160 180	Direct duct connection		

All duct pieces made from galvanised steel.

Roof terminations

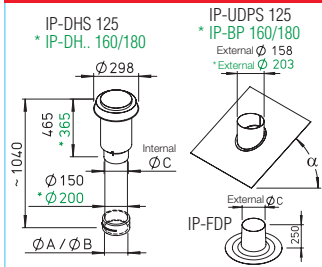

IsoPipe®	Ø 125 mm			Ø 160 mm			Ø 180 mm		
	Type	Ref. no.	Dim. in mm Ø B Ø C	Type	Ref. no.	Dim. in mm Ø B Ø C	Type	Ref. no.	Dim. in mm Ø A Ø C
Roof terminations, consisting of outlet and plate*									
– Roof outlet black	IP-DHS 125	3541	157 160	IP-DHS 160	3542	192 210	IP-DHS 180	3542	180 210
– inclusive ducting red	—	—		IP-DHR 160	3543	192 210	IP-DHR 180	3543	180 210
– Weathering plate for pitched roofs, with leaded sheet	IP-UDPS 125	3546	α 25°– 45°	IP-BP 160/25	9384	α 20°– 30°	IP-BP 180/25	9384	α 20°– 30°
	—	—		IP-BP 160/35	9385	α 30°– 40°	IP-BP 180/35	9385	α 30°– 40°
	—	—		IP-BP 160/45	9386	α 40°– 50°	IP-BP 180/45	9386	α 40°– 50°
– Weathering plate f. flat roof	IP-FDP 125	3544	— 158	IP-FDP 160	3545	— 203	IP-FDP 180	3545	— 203

* Please order roof outlets and roof pantiles each separately.

IsoPipe® facade panels



IsoPipe® facade panels made from high-grade steel for connection to outside air and exhaust air ducts.

■ Properties

All IsoPipe® facade panels are made from high-grade stainless steel.

Alternatively available in coated version (type B) for use in environments with severe air pollution or high salt concentrations in the air (near the coast).

■ Use and installation

□ Facade combination panel IP-FKB

Designed for the compact installation of IsoPipe® outside air and exhaust air ducts with just one facade panel. Universally applicable for horizontal or vertical installation.

Exhaust air spigots can be posi-

tioned on the right, left or on top.

□ Exhaust air facade panel IP-FBF

For the IsoPipe® ducting system. Horizontal installation. The exhaust air is horizontally discharged directly through the pipe nozzles.

□ Outside air facade panel IP-FBA

For the IsoPipe® ducting system. Horizontal installation. The outside air intake takes place on both sides.

IP-FKB

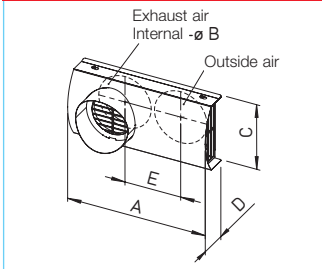

IsoPipe®	Ø 125 mm					Ø 160 mm					Ø 180 mm				
	Type	Ref. no.				Type	Ref. no.				Type	Ref. no.			
Facade combination panel															
– Stainless steel	IP-FKB 125	2689	A	Ø B	C D E	IP-FKB 160	2694	A	Ø B	C D E	IP-FKB 180	2695	A	Ø B	C D E
			420	157	200 100 170			480	192	240 118 210			520	212	290 150 230
– Stainless steel, with additional coating	IP-FKB 125 B	2661	A	Ø B	C D E	IP-FKB 160 B	2662	A	Ø B	C D E	IP-FKB 180 B	2663	A	Ø B	C D E
			420	157	200 100 170			480	192	240 118 210			520	212	290 150 230

Exhaust air right, left or upward.

IP-FBF

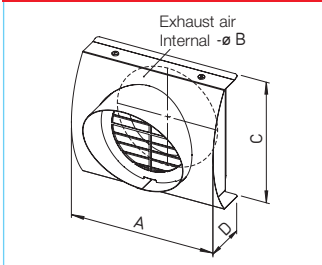

IsoPipe®	Ø 125 mm				Ø 160 mm				Ø 180 mm			
	Type	Ref. no.			Type	Ref. no.			Type	Ref. no.		
Facade panel												
– Stainless steel, exhaust air	IP-FBF 125	3126	A	Ø B C D	IP-FBF 160	3128	A	Ø B C D	IP-FBF 180	3131	A	Ø B C D
			230	157 200 78			265	192 240 97			285	212 260 126
– Stainless steel, exhaust air with additional coating	IP-FBF 125 B	2901	A	Ø B C D	IP-FBF 160 B	2902	A	Ø B C D	IP-FBF 180 B	2903	A	Ø B C D
			230	157 200 78			265	192 240 97			285	212 260 126

IP-FBA

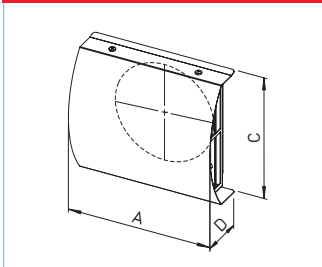

IsoPipe®	Ø 125 mm			Ø 160 mm			Ø 180 mm					
	Type	Ref. no.			Type	Ref. no.			Type	Ref. no.		
Facade panel												
– Stainless steel, outside air	IP-FBA 125	3125	A	C D	IP-FBA 160	3127	A	C D	IP-FBA 180	3130	A	C D
			230	200 78			265	240 97			285	260 126
– Stainless steel, outside air with additional coating	IP-FBA 125 B	2664	A	C D	IP-FBA 160 B	2665	A	C D	IP-FBA 180 B	2666	A	C D
			230	200 78			265	240 97			285	260 126

■ Installation

□ Type IP-FKB universally applicable for horizontal or vertical installation. Exhaust air right, left or upward. The figure to the left shows horizontal installation on outside wall.

□ Types IP-FBF and IP-FBA for horizontal installation.



Design grilles for wall and floor installation

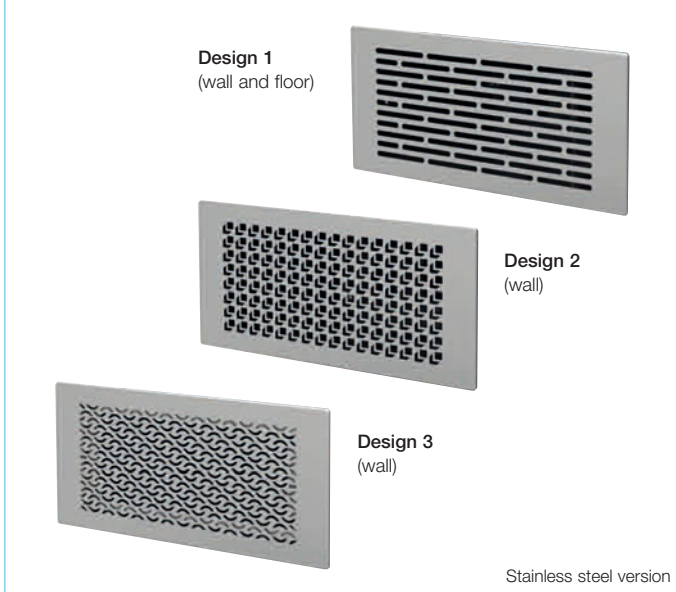

The attractive wall-grille in three elegant designs (stainless steel or coated signal white) fit perfectly in the room ambience and ensure a pleasant draught-free inflow of supply air.

■ Specification wall-grille set

Grille for wall/floor boxes FRS-WBK 2-51.

- Set consists of: Metal wall-grille with mounting frame and insert filter.

■ Surfaces / Colours

- with powder-coating in white: FRS-WGS 1, FRS-WGS 2 and FRS-WGS 3.
- Made from high-grade stainless steel: FRS-WGS 1 E, FRS-WGS 2 E and FRS-WGS 3 E.

Floor-grille set for flush floor installation. Three-dimensional adjustable balancing mechanism for adjusting the grille to the different floor covering heights or for the alignment to overhanging walls or windows.

■ Specification floor-grille set

Grille for multi-floor boxes FRS-MBK 2-75 and wall/floor boxes FRS-WBK 2-51.

- Set consists of: Grille frame, design floor-grille and insert filter.

■ Surfaces / Colours

- Made from high-grade stainless steel: FRS-BGS 1.

Wall-grille set / Design 1 ○

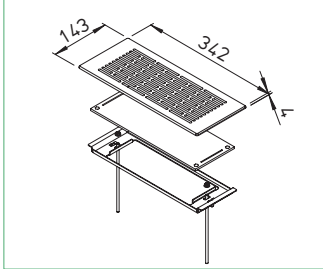

Wall-grille set

Type	Ref. no.	Colour
FRS-WGS 1 ○	3881	White
FRS-WGS 1 E ○	3886	Stainl. steel

Spare filter mats for insert filter:
Type ELF-WGS, Ref. no. 3915, SU = 2 pcs.



- Wall-grille set FRS-WGS 1 E with wall/floor box FRS-WBK 2-51.

Wall-grille set / Design 2 ○

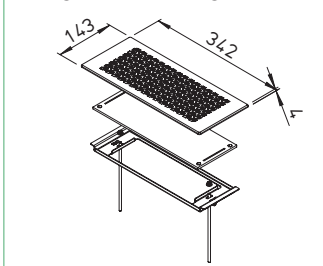

Wall-grille set

Type	Ref. no.	Colour
FRS-WGS 2 ○	3882	White
FRS-WGS 2 E ○	3892	Stainl. steel

Spare filter mats for insert filter:
Type ELF-WGS, Ref. no. 3915, SU = 2 pcs.



- Wall-grille set FRS-WGS 2 E with wall/floor box FRS-WBK 2-51.

Wall-grille set / Design 3 ○

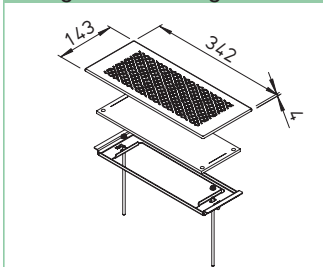

Wall-grille set

Type	Ref. no.	Colour
FRS-WGS 3 ○	3883	White
FRS-WGS 3 E ○	3904	Stainl. steel

Spare filter mats for insert filter:
Type ELF-WGS, Ref. no. 3915, SU = 2 pcs.



- Wall-grille set FRS-WGS 3 E with wall/floor box FRS-WBK 2-51.

Floor-grille set ○○

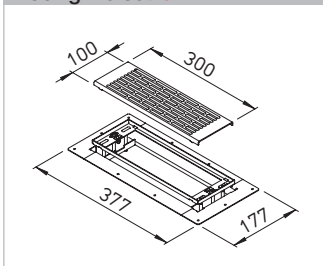

Floor-grille set

Type	Ref. no.	Colour
FRS-BGS 1 ○○	3878	Stainl. steel

Spare filter mats for insert filter:
Type ELF-BGS, Ref. no. 3914, SU = 2 pcs.



- Floor-grille set FRS-BGS 1 with wall/floor box FRS-WBK 2-51. Also fits multi-floor box FRS-MBK 2-75.

Air distribution system RenoPipe

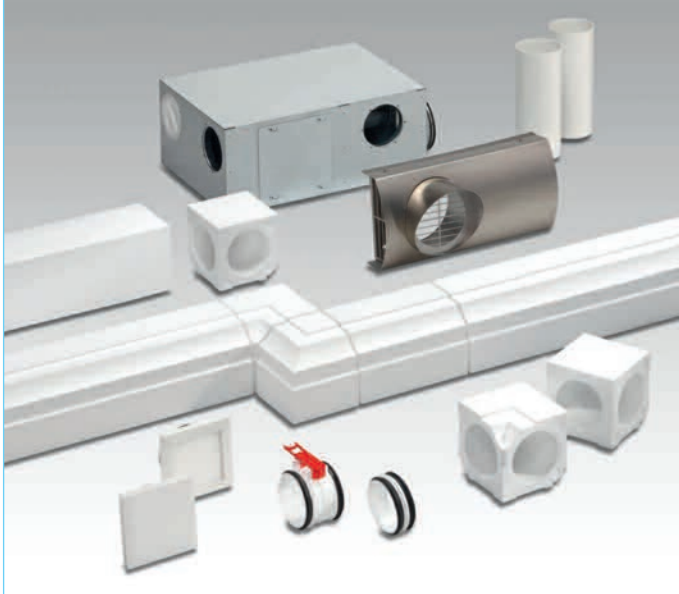

The clever solution especially developed for energy-saving renovation: RenoPipe combines the ventilation ducts and aesthetic covers in one unit.

- Fast, easy installation even in inhabited buildings.
- Mounting does not require reworking using dry construction techniques.
- The material need is reduced to a minimum.
- Economically by few components and no need for extracted air outlets.

■ Mounting

- The RenoPipe fittings can be easily, individually shortened with a precision saw.
- Surface mounting to the ceiling or wall; simply click the long connectors into the fixing clamps included in the contents of delivery.

- Free-cutting the ducts can level out the ceiling and wall surfaces, mitre cuts are unnecessary for accurately formed parts. Length, transverse and level adjustments can guarantee the perfect sit.

■ Features and advantages

- Components made from highly compressed EPS in white, which can be painted over.
- Fast surface mounting, without time-consuming cover suspensions and dry constructionworks.

■ Distribution system, mounting

- The used air of the kitchen and bathrooms is collected directly in the sound insulated combination distribution box. No need of extracted air outlets and separate attenuators.
- Asymmetrical rubber lip-seals provide airtight connection of the complete RenoPipe system.

Combination distributor

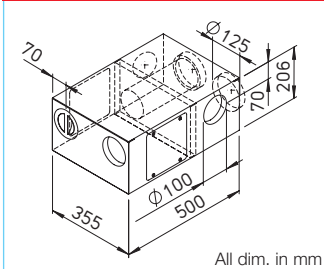

RenoPipe combination distribution box, supply air right

Compact distributor from galvanised sheet steel with sound absorbing lining inside. Features: Extract air collector, supply air distributor with sound attenuation function. Unit connection 2 DN 125, 2 x DN 100 for extraction, 2 x DN 100 for supply air. Includes inspection opening and cover plate.

RP-KVK 3-100/125 R No. 3048

Duct section

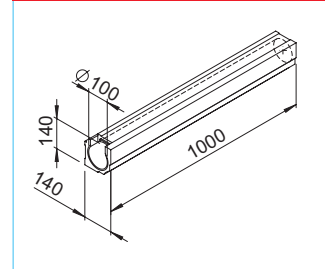

Duct

SU = 4 pcs.*
Duct piece with smooth, square profile. Inside diameter DN 100, length 1 m.

RP-K Ref. no. 3061

Duct with stucco profile

SU = 4 pcs.*
Like above, but with visually attractive stucco profile.

RP-SK Ref. no. 3065

Combination distributor

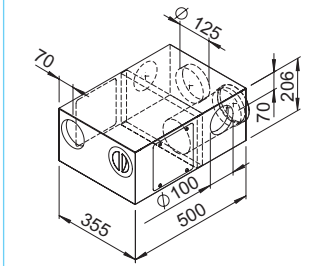

RenoPipe combination distribution box, supply air left

Compact distributor from galvanised sheet steel with sound absorbing lining inside. Features: Extract air collector, supply air distributor with sound attenuation function. Unit connection 2 DN 125, 2 x DN 100 for extraction, 2 x DN 100 for supply air. Includes inspection opening and cover plate.

RP-KVK 3-100/125 L No. 3038

T-section

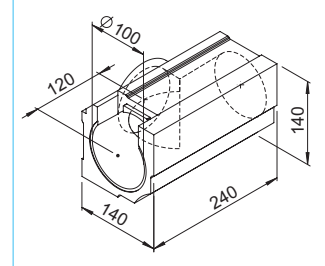

T-section

SU = 4 pcs.*
Compact T-piece with smooth, square profile. Inside diameter DN 100/100/100.

RP-T Ref. no. 3062

T-section with stucco profile

SU = 4 pcs.*
Like above, but with visually attractive stucco profile.

RP-ST Ref. no. 3066

Long connector set

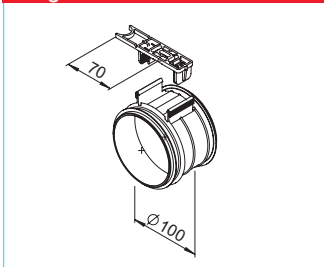

Long connector set

Consisting of connection sleeve DN 100 from impact resistant polypropylene and two rubber lip-seals for airtight connection with duct piece. Clamp for easy snap mounting of duct piece, included in delivery.

RP-LV Ref. no. 3029

Inner angle

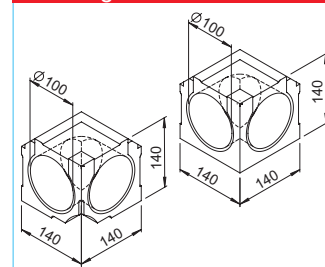

Inner angle

SU = 2 pcs.*
90°-interior angle piece in compact cube form with smooth, square profile. Inside diameter DN 100.

RP-IW Ref. no. 3075

Inner angle with section

SU = 2 pcs.*
Like above, but with visually attractive stucco profile.

RP-SIW Ref. no. 3077

Short connector



Short connector

Impact resistant polypropylene including rubber lip-seals for airtight connection with RenoPipe EPS shaped parts and wall sleeve.

RP-KV Ref. no. 3030

Outer angle

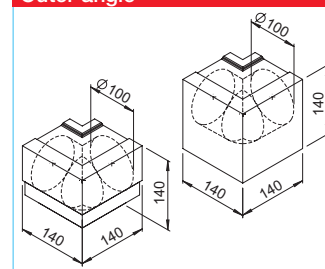

Outer angle

SU = 2 pcs.*
90°-exterior angle piece in compact cube form with smooth, square profile. Inside diameter DN 100.

RP-AW Ref. no. 3076

Outer angle with section

SU = 2 pcs.*
Like above, but with visually attractive stucco profile.

RP-SAW Ref. no. 3078

* Supplied in packaging units.

Ventilation valve

All dimensions in mm

Design ventilation valve
Design ventilation valve for extract air operation, DN 100, adjustable. With concealed opening and integrated filter.

DLV 100 Ref. no. 3039

Replacement air filters
SU = 5 pc.*
ELF-DLV 100 Ref. no. 3042

Cutting guide

Cutting guide
Practical cutting guide, beech multiplex 15 mm, for easy cutting duct piece to length.

RP-SH Ref. no. 3036

Ventilation valve

Design ventilation valve for supply air
Design ventilation valve for supply air operation, DN 100.

DLVZ 100 Ref. no. 3040

Precision saw

Precision saw
Special hand slitting saw for slight cuts.

RP-FS Ref. no. 3044

Facade combination panel

Facade combination panel
for connection of outside and exhaust air. Univers. appl., outside air alternatively left, right or below. Perfectly designed from high grade steel. Connection DN 125.

IP-FKB 125 Ref. no. 2689

With additional coating for use in environ. with severe air pollution or high salt concentration in air.

IP-FKB 125 B Ref. no. 2661

Clamp

Clamp SU = 5 pcs.*
From high quality, impact resistant polymer.

RP-BK Ref. no. 3031

Exhaust air panel

Exhaust air panel
Perfectly designed, from high grade steel. Connection DN 125.

IP-FBF 125 Ref. no. 3126

With additional coating for use in environ. with severe air pollution or high salt concentration in air.

IP-FBF 125 B Ref. no. 2901

Seal

Seal SU = 10 pcs.*
DN 100 from EPDM.

RP-LD Ref. no. 3033

Outside air panel

Outside air panel
Perfectly designed, from high grade steel. Connection DN 125.

IP-FBA 125 Ref. no. 3125

With additional coating for use in environ. with severe air pollution or high salt concentration in air.

IP-FBA 125 B Ref. no. 2664

Wall casing Final- and inspection lid

Wall casing Final- and inspection lid
DN 100 from high quality polymer, with rubber lip-seal. For installation at duct piece.

RP-RD Ref. no. 3037

Wall casing

Wall casing
DN 100 from PVC, including mounting template for easy wall penetration.

RP-WH Ref. no. 3035

Reduction

Reduction
From galvanised sheet steel.

RP-RZ 125/100 Ref. no. 3017

* Supplied in packaging units.

FlexPipe® plus round and oval ducting system. Arbitrarily combinable.



FlexPipe® plus is the further development of the successful air distribution system FlexPipe® and unites round and oval pipe as of now in a clever system package with all conceivable round-oval combinations.

The new oval pipe has the identical hydraulic cross-section and pressure loss like the round pipe as well as a point-symmetric design. This leads to unique advantages:

- No matter if it's planning and layout or installation and adjustment or maintenance, round and oval pipe behave completely identical.
- Depending on the structural condition, therefore any changes between round and oval pipe by means of adapters are possible. This along the line as well as from the distribution box away. This offers greatest possible freedom during planning and

- installation.
- The ideal, cost-effective option can be selected at any time. The space-saving oval pipe is mainly used when low structure heights are required.
- The round-oval-compatibility leads to a low parts variety. Stockpiling and consultation are strongly simplified. The installation is almost intuitively carried out.
- The point-symmetric oval design allows the laying from the horizontal line into vertical without the use of adapter pieces to the position correction.

Note
 FlexPipe ducting system with outer-Ø: 63 mm, inner: 52 mm for air flow volume up to 20 m³/h see page 132

■ FlexPipe® plus contains two design types which are arbitrarily combinable:

- FRS 75, round:
 Outer-Ø: 75 mm, inner: 63 mm for air flow vol. up to 30 m³/h. For laying into concrete. High resilience (STIS ≥ 10 kN/m² to DIN EN 9969). Bending radius horizontal and vertical 150 mm.
- FRS 51, oval:
 51 x 114 mm, for air flow volume up to 30 m³/h, ideal for space-saving laying e.g. on the unfinished floor or in the wall. Bending radius horizontal 300 mm, vertical 200 mm.

■ Laying, handling, initiation

- Easiest planning thanks to identical pipe cross-sections and pressure losses.
- Fast to install through star shaped laying.
- Convenient handling due to the light weight.
- Fast initiation as the adjustments are reduced to a minimum.
- Constant air distribution.
- Easy to clean, hygienically perfect.

■ Duct characteristics and advantages

- The round and oval pipe consists of quality-assured PE-HD made of new raw material.
- The outside is ribbed where as the inner surface is absolutely smooth and antistatically coated. This minimizes the pressure losses and prevents flow-generated noise and dirt deposits.

- The extreme horizontal and vertical bending elasticity of both pipe geometries reduces the number of required fittings to a minimum.
- Due to the point-symmetric design the laying of the oval pipe is vertically up- or downwards from the horizontal line possible without adapter pieces.

■ Laying-conception/installation

- Fixing brackets on all parts for secure fixing to floor, wall, or ceiling.
- Unlockable fixing clips guarantee the fast and no-pull-out pipe mounting on all joints.
- By sound absorbing distribution boxes additional cross-talk sound attenuators are omitted.
- Precise sealing system on all fittings for leakage-free air transportation.
- Many different components ensure the perfect solution for nearly every request. There are ceiling outlets available for all kind of valves with ND 125 as well as wall and floor outlets, delivered with grilles as standard. They each have two parallel pipe connections for the low pressure loss airflow of the required air flow volumes to DIN 1946-6.

○ FlexPipe® plus round pipe in the concrete ceiling



○ FlexPipe® plus oval pipe on the unfinished floor

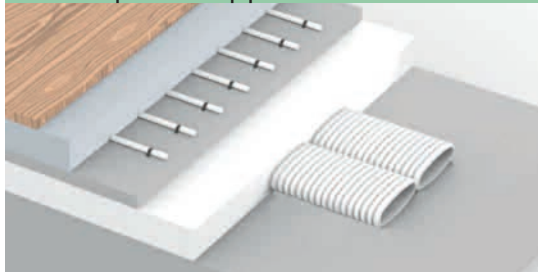

○ FlexPipe® plus allows any round-oval-combination



FlexPipe® duct round ○

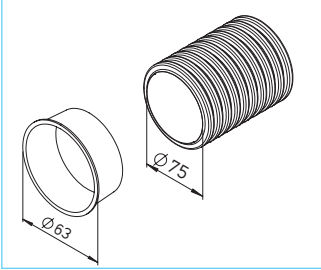

FlexPipe® duct (bundle = 50 running mtrs)

Type	Ref. no.	Dim. in mm	
Ø 75 mm		Outer-Ø	Inner-Ø
FRS-R 75 ○	2913	75	63

Hygiene-duct cap

FRS-VD 75 ○	2915	10 pcs.
-------------	------	---------

Flexible round pipe from PE-HD, ideal for the laying into the concrete ceiling. Incl. two hygiene-duct caps, in addition can be ordered separately.

FlexPipe® duct oval ○

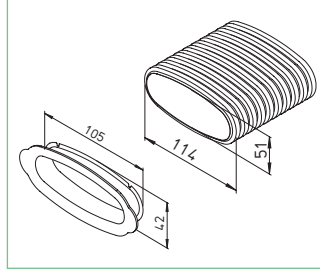

FlexPipe® duct oval (bund = 20 run m)

Type	Ref. no.	Dim. in mm	
114 x 51 mm		Width	Height
FRS-R 51 ○	3850	114	51

Hygiene-duct cap

FRS-VD 51 ○	3866	10 pcs.
-------------	------	---------

Flexible oval pipe from PE-HD, for space-saving laying on the unfinished floor, installation in the wall or false ceiling. Incl. two hygiene-duct caps, in addition can be ordered separately.

Cap, seal ring, clip ○

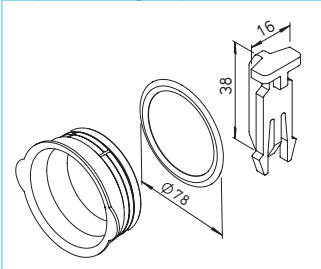

Cap, seal ring, clip

Type	Ref. no.	SU
Ø 75 mm		

Spigot cap with sealing

FRS-VDS 75 ○	3855	1 pc.
--------------	------	-------

Seal ring

FRS-DR 75 ○	2916	10 pcs.
-------------	------	---------

Clip, unlockable

FRS-FK ○○	3854	10 pcs.
-----------	------	---------

Cap, seal ring, clip ○

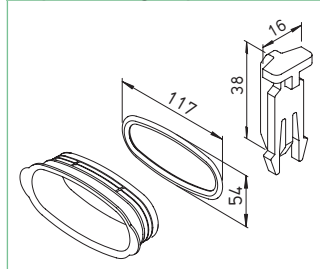

Cap, seal ring, clip

Type	Ref. no.	SU
114 x 51 mm		

Spigot cap with sealing

FRS-VDS 51 ○	3856	1 pcs.
--------------	------	--------

Seal ring

FRS-DR 51 ○	3864	10 pcs.
-------------	------	---------

Clip, unlockable

FRS-FK ○○	3854	10 pcs.
-----------	------	---------

Connection sleeve ○

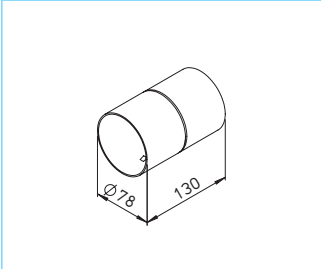

Connection sleeve

Type	Ref. no.
Ø 75 mm	

FRS-VM 75 ○	2914
-------------	------

Connection sleeve for round pipe FRS-R 75 with interlocking protection on both sides, from polyethylene.

Connection sleeve ○

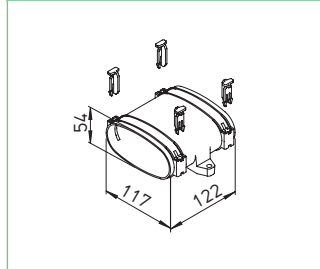

Connection sleeve

Type	Ref. no.
114 x 51 mm	

FRS-VM 51 ○	3862
-------------	------

Connection sleeve for oval pipe FRS-R 51, with integrated fixing brackets, incl. pipe fixing clips (4 pcs). Made from impact-resistant polypropylene.

Short elbow 90° ○

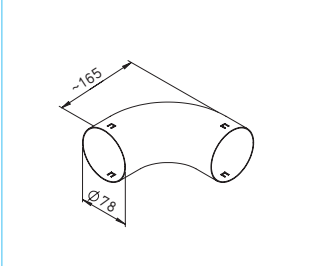

Short elbow 90°

Type	Ref. no.
Ø 75 mm	

FRS-B 75 ○	2994
------------	------

Elbow 90° for bend radius < 2 x duct outer diameter. Horizontal and vertical use with interlocking protection on both sides. Made from galvanised sheet steel.

Elbow horizontal / vertical ○

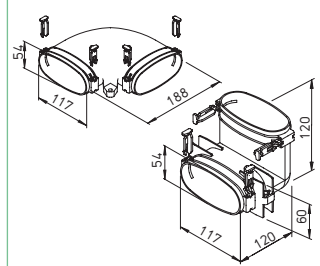

Elbow horizontal / vertical

Type	Ref. no.
114 x 51 mm	

FRS-BH 51 ○	3863
-------------	------

FRS-BV 51 ○	3859
-------------	------

Horizontal or vertical elbow 90°. With integrated fixing brackets, incl. pipe fixing clips (4 pcs). Made from impact-resistant polypropylene.

■ Any combination of round and oval pipe

- With FlexPipe® plus from Helios you decide for one system and have – depending on the object requirement – the perfect solution in the access.
- The only 51 mm super flat oval pipe is then used, when low construction height is required. The approved round pipe is offered for the direct laying into the concrete ceiling.
- Thanks to identical hydraulic cross-sections and pressure losses of the two pipes and due to well-conceived system components you can combine round and oval as required. This along the line as well as from the distribution box away.



Vertical and horizontal adapters allow each round/oval, oval/oval and round/round combination.



The distribution boxes can be equipped with round and oval single spigots as well as combined.

Adaptor straight / vertical ○○

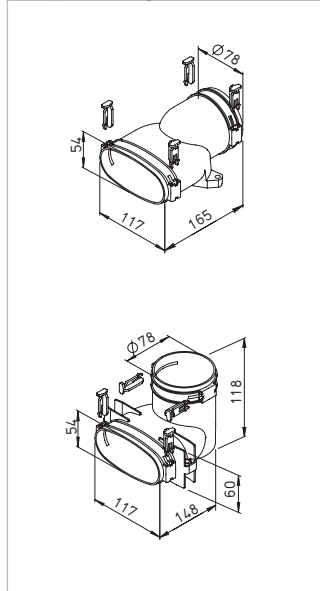

Adaptor straight / vertical

Type	Ref. no.
Ø 75 mm / 114 x 51 mm	

Adaptor straight

FRS-ÜG 51-75 ○○	3861
-----------------	------

Adaptor vertical

FRS-ÜV 51-75 ○○	3860
-----------------	------

Horizontal and vertical adapter from round pipe FRS-R 75 to oval pipe FRS-R 51. With integrated fixing brackets, incl. pipe fixing clips (4 pcs). Made from impact-resistant polypropylene.

Ceiling-/wall outlet

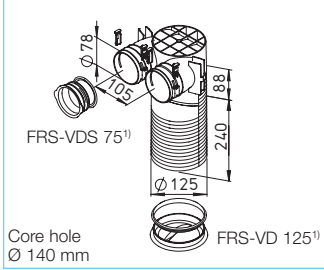

Ceiling-/wall outlet

Type Ø 75 mm Ref. no.
FRS-DWK 2-75/125 ○ 3857
Extension for ceilings > 240 mm
FRS-VV 125 ○ ○ 3906

Ceiling-/wall outlet to connect max. 2 round pipes FRS-R 75. For intake and extract valves DN 125. Integrated bench marks for precise shortening. Incl. spigot cap with seal ring¹) 75 mm and DN 125 (each 1 pc). With integrated fixing brackets, incl. pipe fixing clips (4 pcs). From impact-resistant polypropylene.

Ceiling-/wall outlet

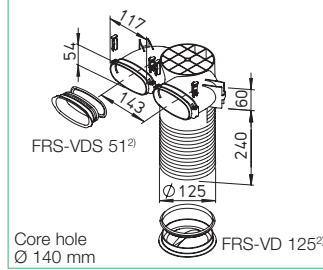

Ceiling-/wall outlet

Type 114 x 51 mm Ref. no.
FRS-DWK 2-51/125 ○ 3858
Extension for ceilings > 240 mm
FRS-VV 125 ○ ○ 3906

Ceiling-/wall outlet to connect max. 2 oval pipes FRS-R 51. For intake and extract valves nom. dia. 125. Integrated bench marks for precise shortening. Incl. spigot cap with seal ring¹) 75 mm and DN 125 (each 1 pc). With integrated fixing brackets, incl. pipe fixing clips (4 pcs). From impact-resistant polypropylene.

Multi-floor outlet

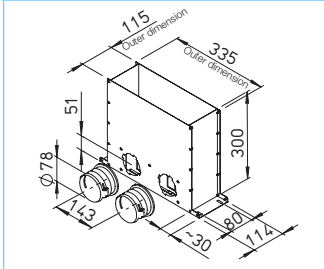

Multi-floor outlet

Type Ref.
Ø 75 mm no.
FRS-MBK 2-75 ○ 3872

Multi-floor outlet to connect max. 2 round pipes FRS-R 75. Suitable for casting in concrete ceiling, consisting of:

- Floor outlet for grille in robust sheet-metal design
- 2 pcs. single spigots (round) and 1 pc. spigot cap with sealing (round)

Multi-floor outlet

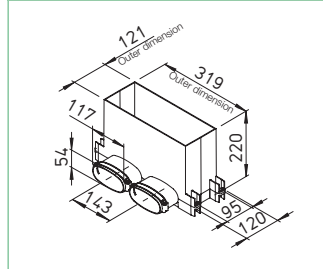

Multi-floor outlet

Type Ref.
114 x 51 mm no.
FRS-WBK 2-51 ○ 3877

Multi-floor outlet to connect max. 2 oval pipes FRS-R 51. Suitable for casting in concrete ceiling, consisting of:

- Polymer outlet from impact-resistant polypropylene with air volume regulation. For use with FRS-WGS or FRS-BGS. 1 pc. spigot cover with seal (oval).

Floor grille kit

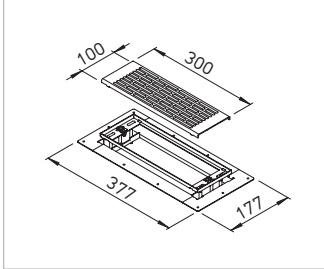

Floor grille kit

Type Ref. no.
FRS-BGS 1 ○ ○ 3878

Floor grille kit from high-quality steel for multi-floor outlet FRS-MBK 2-75 and wall/floor outlet FRS-WBK 2-51, consisting of:

- Grille frame with height adjustment for threshold-free installation in flooring
- Penetration-proof design floor grille
- Insert filter (spare filter mat ELF-BGS, Ref. no. 3914, SU = 2 pcs.)

Wall grille set

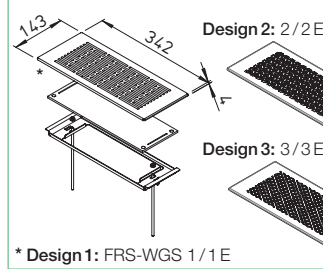

Wall grille set

Type Ref. no. Color

FRS-WGS 1 ○	3881	white
FRS-WGS 2 ○	3882	white
FRS-WGS 3 ○	3883	white
FRS-WGS 1 E ○	3886	stainless st.
FRS-WGS 2 E ○	3892	stainless st.
FRS-WGS 3 E ○	3904	stainless st.

Wall grille set with installation frame and insert filter for FRS-WBK 2-51. Grille designs see p. 125.

Floor outlet set

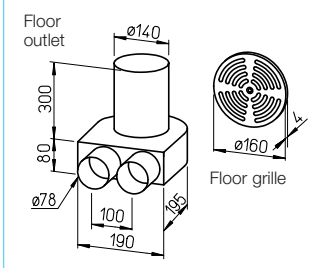

Floor outlet set

Type Ref.
Ø 75 mm no.
FRS-BKGS 2-75 ○ 9992

Floor outlet with grille consisting of:

- 1 pc. floor outlet for grille nom. dia. 160
- 1 pc. floor grille from high-quality steel with adjustable air flow.
- 1 pc. cap

Wall mounting kit

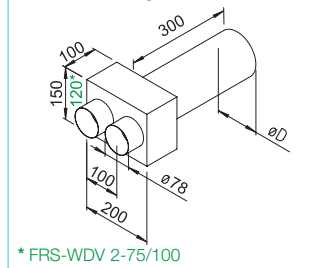

Wall mounting kit for valve connection

Type Ref. Ø D
Ø 75 mm no. mm

FRS-WDV 2-75/100 ○	9621	100
FRS-WDV 2-75/125 ○	9622	125

Wall mounting kit including plaster cover plate and cap (1 pc). For connection of supply or extract air valves nom. dia. 100 or 125.

Grille with box

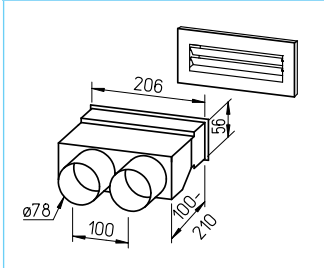

Grille with box, straight

Type Ref.
Ø 75 mm no.
FRS-WDS 2-75 ○ 9994

Grille with box consisting of:

- outlet box with sliding type fitting
- grille white (FK-WA 200 W), 250 x 103 mm
- 1 pc. cap

Grille with elbow box

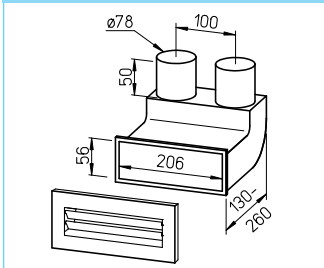

Grille with elbow box, 90°

Type Ref.
Ø 75 mm no.
FRS-WBS 2-75 ○ 9996

Grille with elbow box consisting of:

- elbow box with sliding type fitting
- grille white (FK-WA 200 W), 250 x 103 mm
- 1 pc. cap

Basic site package



Basic site package

Type Ref. Ø D
FRS-RP 75 ○ 9397 75

FlexPipe® duct system basic site package:

- 3 pcs. FRS-R 75 (Ref. no. 2913)
- 2 pcs. FRS-VK 10-75/160 (Ref. no. 3847)
- 8 pcs. FRS-DWK 2-75/125 (Ref. no. 3857)
- 7 pcs. FRS-B 75 (Ref. no. 2994)
- 7 pcs. FRS-VM 75 (Ref. no. 2914)
- 4 SU FRS-DR 75 (Ref. no. 2916)
- 1 SU FRS-VD 75 (Ref. no. 2915)
- 1 pc. Cold shrinking strip KSB (Ref. no. 9343)

Choosing the Helios basic site package, saves

- money as you will benefit from the package price.
- time because everything you need is already included. That way you can start right away.

¹) Cap with integrated sealing FRS-VDS 75, Ref.-No. 3855 and -VD 125, Ref.-No. 3865.
Cap can be used for single sigot- respectively pipe connection opening at the distribution box.

²) Cap with integrated sealing FRS-VDS 51, Ref.-No. 3856 and -VD 125, Ref.-No. 3865.
Cap can be used also for single sigot- respectively pipe connection opening at the distribution box.

Multi-distribution box 4+1

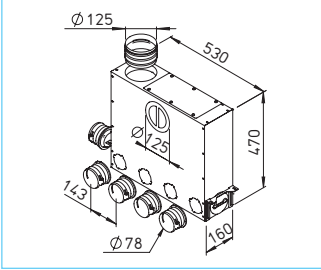

Multi-distribution box¹⁾

Type	Ref. no.	Ø NW
Ø 75 mm		
FRS-MVK 4+1-75/125	3843	125

For universal installation in/on the concrete ceiling. With height-adjustable mounting brackets. Pipe connection nom. dia. 125 is horizontally or vertically possible as an option. 10 connections for up to 5 flexible pipes FRS-R 75. With sound absorbing lining and large inspection opening.

Multi-distribution box 4+1

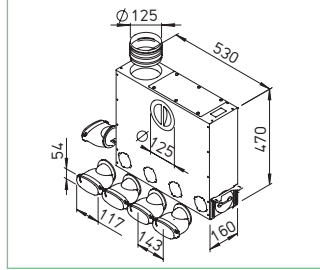

Multi-distribution box¹⁾

Type	Ref. No.	Ø NW
114 x 51 mm		
FRS-MVK 4+1-51/125	3841	125

For universal installation on the concrete ceiling. With height-adjustable mounting brackets. Pipe connection nom. dia. 125 is horizontally or vertically possible as an option. 10 connections for up to 5 flexible pipes FRS-R 51. With sound absorbing lining and large inspection opening.

Multi distribution box 5+2-fold

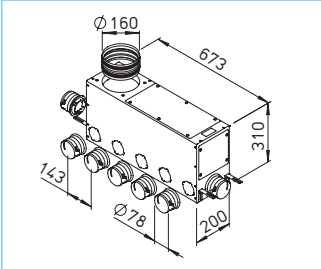

Multi distribution box¹⁾

Type	Ref. no.	Ø NW
Ø 75 mm		
FRS-MVK 5+2-75/160	3836	160

For universal installation in/on raw concrete ceiling. With height-adjustable mounting brackets. Pipe connections DN 160 horizontal or vertical are optional. 12 connection options for up to 7 ventilation ducts FRS-R 75. With sound-absorbing lining and large inspection opening.

Multi distribution box 5+2-fold

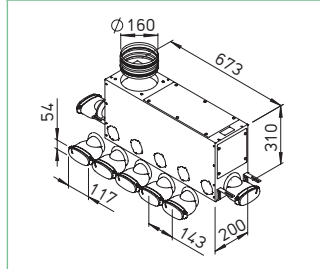

Multi distribution box¹⁾

Type	Ref. no.	Ø NW
114 x 51 mm		
FRS-MVK 5+2-51/160	3838	160

For universal installation in/on raw concrete ceiling or as a floor distributor. With height-adjustable mounting brackets. Pipe connections DN 160 horizontal or vertical are optional. 12 connection options for up to 7 oval ventilation ducts FRS-R 51. With sound-absorbing lining and large inspection opening.

Distribution box 10-fold

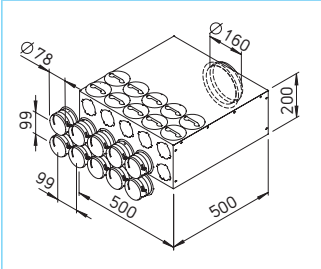

Distribution box 10-75²⁾

Type	Ref. no.	Ø NW
Ø 75 mm		
FRS-VK 10-75/160	3847	160

20 connection possibilities for up to 10 flexible pipes FRS-R 75. Optional mounting as straight-through-, 90°-distributor or combined. Combined installation with oval single spigots possible (FRS-ES 51, Ref.-No. 3851, see below). With sound absorbing lining and large inspection opening.

Distribution box 10-fold

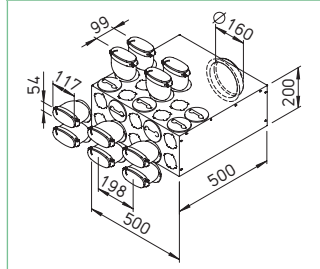

Distribution box 10-51²⁾

Type	Ref. no.	Ø NW
114 x 51 mm		
FRS-VK 10-51/160	3849	160

20 connection possibilities for up to 10 flexible pipes FRS-R 51. Optional mounting as straight-through-, 90°-distributor or combined. Combined installation with round single spigots possible (FRS-ES 75, Ref.-No. 3852, see below). With sound absorbing lining and large inspection opening.

Flat distribution box 6-fold

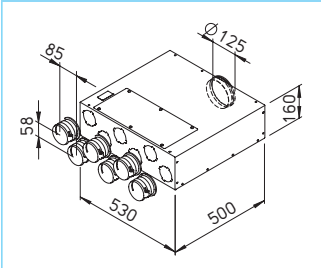

Distribution box 6-75, flat-design¹⁾

Type	Ref. no.	Ø NW
Ø 75 mm		
FRS-FVK 6-75/125	3845	125

To connect up to 6 flexible pipes FRS-R 75. Mounting as straight-through distributor. Combined installation with oval single spigots possible (FRS-ES 51, Ref.-No. 3851, see below). With sound absorbing lining and large inspection opening.

Distribution box 6-fold

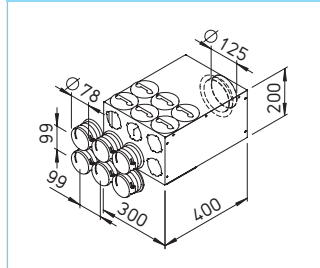

Distribution box 6-75¹⁾

Type	Ref. no.	Ø NW
Ø 75 mm		
FRS-VK 6-75/125	3846	125

12 connection possibilities for up to 6 flexible pipes FRS-R 75. Optional mounting as straight-through-, 90°-distributor or combined. Combined installation with oval single spigots possible (FRS-ES 51, Ref.-No. 3851, see below). With sound absorbing lining and large inspection opening.

Distribution box 15-fold

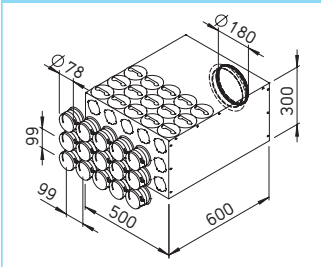

Distribution box 15-75²⁾

Type	Ref. no.	Ø NW
Ø 75 mm		
FRS-VK 15-75/180	3848	180

30 connection possibilities for up to 15 flexible pipes FRS-R 75. Optional mounting as straight-through-, 90°-distributor or combined. Combined installation with oval single spigots possible (FRS-ES 51, Ref.-No. 3851, see below). With sound absorbing lining and large inspection opening.

Single spigot, cap

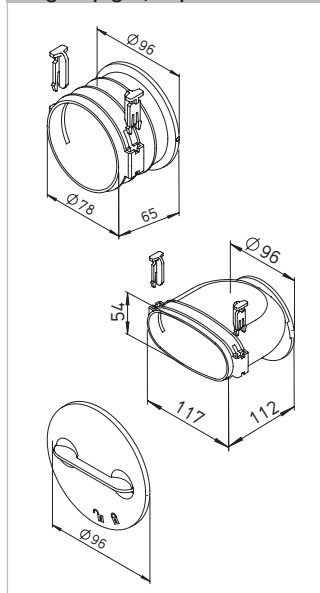

Single spigot, bayonet catch cap

Type	Ref. no.	SU
Single spigot, Ø 75 mm		
FRS-ES 75	3852	1 St.

Type	Ref. no.	SU
Single spigot, 114 x 51 mm		
FRS-ES 51	3851	1 St.

Type	Ref. no.	SU
Bayonet catch cap		
FRS-VDB	3853	1 St.

Additional single spigots to connect round pipe FRS-R 75 and/or oval pipe FRS-R 51 to distribution box. By means of bayonet catch cap simply and variably positionable. Seals tightly, inclusive pipe fixing clips (2 pcs), made from impact-resistant polypropylene. Bayonet catch cap for the single spigot holes at the distribution box.

Compact distribution box

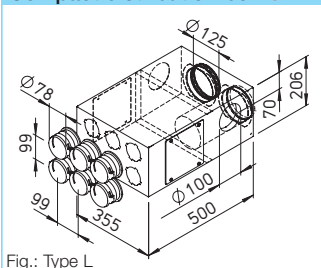

Compact distribution box¹⁾

Type	Ref. no.	Ø NW
Ø 75 mm		
FRS-KVK 6-75/125 L*	3873	125
FRS-KVK 6-75/125 R*	3874	125

* Supply air connection optionally on the left or right. Compact distribution box, perfect next to adjacent exhaust air rooms. 2 x DN 100 for extraction with extract air valves DLV (see accessories). Supply air distribution via connection of up to 6 flexible ducts FRS-R 75.

Fig.: Type L

¹⁾ incl. 2 pcs. caps.

²⁾ incl. 4 pcs. caps.

FlexPipe® flexible ducting system is directly laid into or on the concrete.

- Simple to plan and easy to install through star shaped laying.
- Convenient handling due to the light weight.
- Fast initiation, constant air distribution.
- Easy to clean.

■ Available in two sizes and designs

- FlexPipe® FRS 63
Outer-Ø: 63 mm, inner-Ø: 52 mm for air flow vol. up to 20 m³/h.
- FlexPipe®plus
Outer-Ø: 75 mm, inner-Ø: 63 mm for air flow vol. up to 30 m³/h. Can be combined with oval pipe FRS-R51 and oval components, see page 128 on.

■ Characteristics and advantages

- Special ventilation duct made of hygienically safe PE-HD new material, odourless.
- The two-layered structure – corrugated outside, smooth inside and antistatic – guarantees:
 - very low air flow resistance and high sound absorption.
 - minimal dirt deposits.
 - easy to clean.

■ Laying

- The FlexPipe® polymer pipe has a high resilience ($S_{R24} > 8 \text{ kN/m}^2$) and can simply be laid directly into, on or under the concrete ceiling in the desired course due to the high flexibility.
- Air- and watertight connection is simply made by use of the FRS seal rings.

FlexPipe® duct round



FlexPipe® duct round (bund = 50 run. m)

Type	Ref. no.	Dim. in mm	
Ø 63 mm		Outer-Ø	Inner-Ø
FRS-R 63	9327	63	52

Ceiling outlet

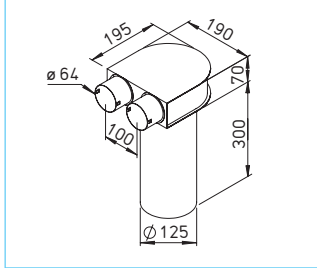

Ceiling outlet 2) for valves DN 125

Type	Ref. no.
FRS-DKV 2-63/125	9430

Ceiling outlet incl. cover to avoid soil in the system during construction work. For intake and extract valves nom. dia. 125 (accessories, see page 136).

Distribution box 6-63, 12-63

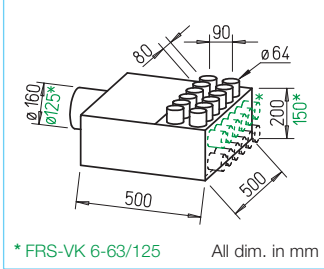

* FRS-VK 6-63/125 All dim. in mm

Distribution box 6-63, 12-63¹⁾

Type	Ref. no.	Ø NW mm
FRS-VK 6-63/125	9355	125
FRS-VK 12-63/160	9336	160

To connect up to 6 or 12 flexible ducts FRS-R 63. As the box is noise-absorbing it is also suitable as silencer element. Choice of manifold position with 12-63, the cover of the access opening. Therefore the distribution box can be used for vertical and horizontal positioning.

Floor outlet with grille

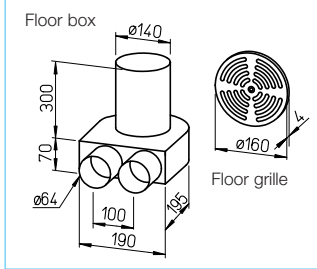

Floor outlet with grille²⁾

Type	Ref. no.
FRS-BKGS 2-63	9991

Floor outlet with grille consisting of:
- 1 floor outlet for grilles nom. dia. 160
- 1 floor grille made of stainless steel with adjustable air flow.

Distribution box 18-63

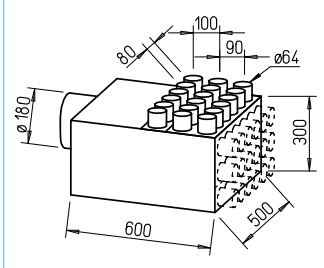

Distribution box 18-63¹⁾

Type	Ref. no.	Ø NW mm
FRS-VK 18-63/180	9364	180

To connect up to 18 flexible ducts FRS-R 63. As the box is noise-absorbing it is also suitable as silencer element. The connecting plate with the pipe spigots is interchangeable with the inspection door and can be shifted by 90°. Therefore the box can be used for vertical and horizontal positioning.

Grille with box

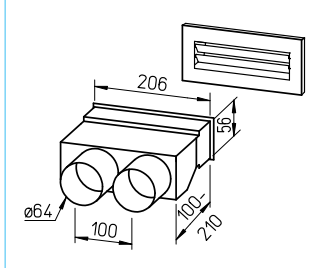

Grille with box, straight²⁾

Type	Ref. no.
FRS-WDS 2-63	9993

Grille with box consisting of:
- outlet box with sliding type fitting
- grille white (FK-WA 200 W), 250 x 103 mm

Short elbow 90°

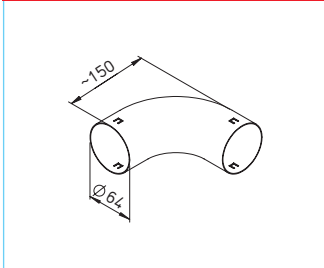

Short elbow 90°

Type	Ref. no.
FRS-B 63	9348

Elbow 90° for bend radius < 2 x duct outer diameter.

Grille with elbow box

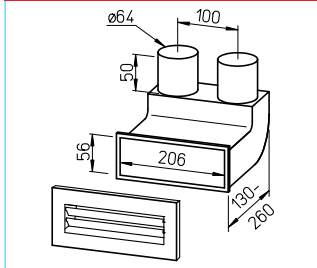

Grille with elbow box, 90°²⁾

Type	Ref. no.
FRS-WBS 2-63	9995

Grille with box consisting of:
- outlet box with sliding type fitting
- grille white (FK-WA 200 W), 250 x 103 mm

Adapting elbow 90°

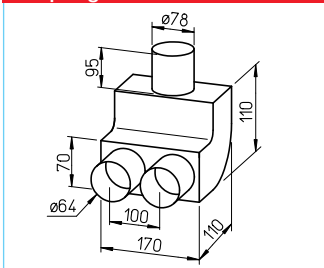

Adapting elbow 90°

Type	Ref. no.
FRS-B 75/2-63	9341

Adapting elbow 90° as adaptor from 1 x 75 mm to 2 flexible ducts nom. dia. 63 mm.

Sleeve, cap, seal ring

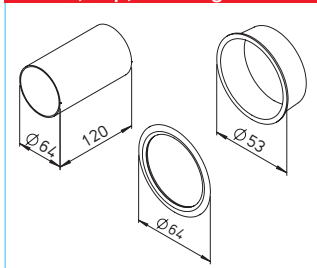

Sleeve, cap, seal ring

Type	Ref. no.	SU
FRS-VM 63	Sleeve	9329
FRS-VD 63	Cap	9330 10 St.
FRS-DR 63	Seal ring	9331 10 St.

Note: At each joint section (pipe/pipe, pipe/fitting), a sealing ring (for IP 66) must be used. Please order corresponding number separately. Coating with a lubricant recommended for the assembly.

¹⁾ incl. 6 pcs. caps. ²⁾ ncl. 1 pc. cap.

Flat polymer duct system F



Laying

- Easy and fast laying due to the low weight.
- Joining of sections of all kinds allows numerous possibilities.
- Space-saving and universal.
- Ideal for renovation of existing buildings and prefabricated houses.

Characteristics

All sections of white, antistatic polymer. Hardly inflammable B1, DIN 4102. Max. temperature +50 °C.

Duct-concept and mounting

- Specially shaped duct alignment
- Starts at either the unit or the distributor air intakes/outlets of the rooms. Branch connection ensured by T-pieces.

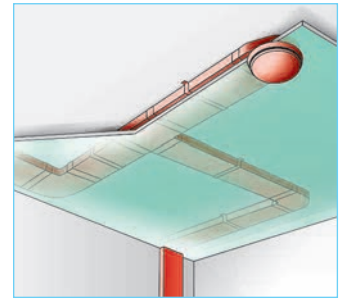

- Cross-section surface for air flow volume of up to 150 m³/h.
- The connections of the formed parts are built as slip-in sleeves; duct connection is done by outside-connection sleeves.
- Requires air-tight connection achieved by using duct tape (accessories).
- Fixation of the pieces using mounting bracket FB.

KWL® with heat recovery

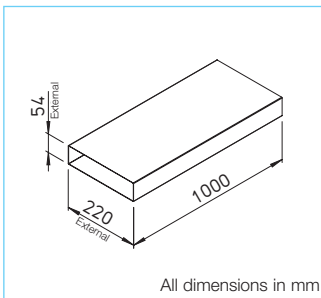

Flat duct w/o sleeve, length 1 m
FOM Ref. no. 0624

All dimensions in mm

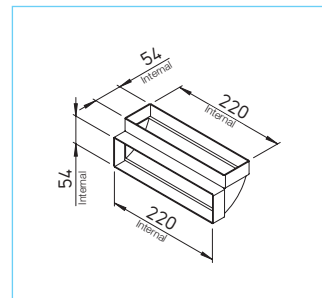

90°-bend vertical
FBV 90 Ref. no. 0630

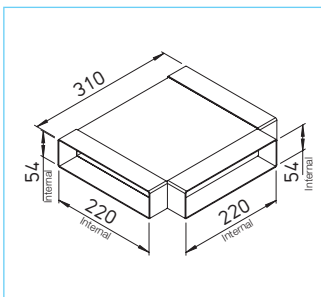

Flat duct T-piece
FTS Ref. no. 0631

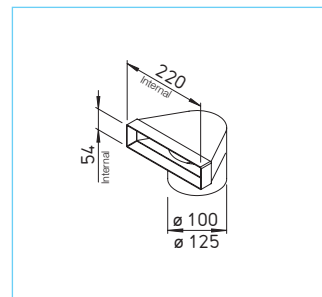

End piece with connection from Ø to □
FE 100 Ref. no. 0621
FE 125 Ref. no. 0622

End piece with connection from Ø to □ with 1 mtr. tube and 2 brackets
FU 90/100 Ref. no. 0627
FU 90/125 Ref. no. 0638

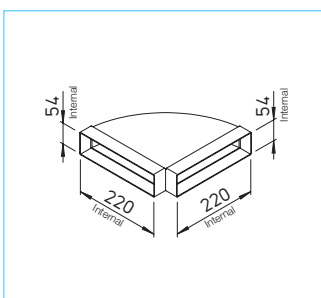

90°-bend horizontal
FBH 90 Ref. no. 0629

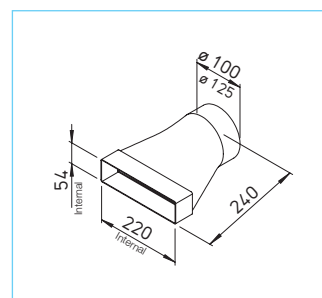

Connection from Ø to □
FUE 100 Ref. no. 0628
FUE 125 Ref. no. 0639

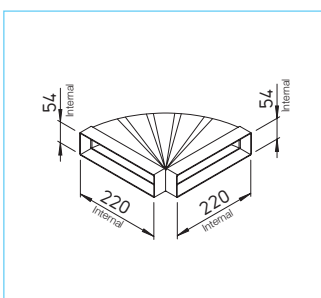

Flexible bend
FBO Ref. no. 0632

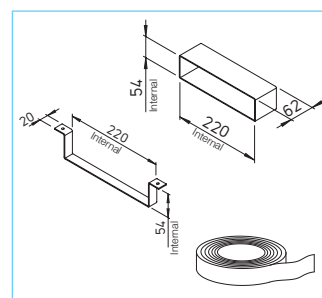

Flat duct connector
FV Ref. no. 0625

Mounting bracket
FB Ref. no. 0626

Strip
KLB Ref. no. 0619
PVS-strip, width 50 mm, roll with 20 mtrs length.

Flat duct system FK

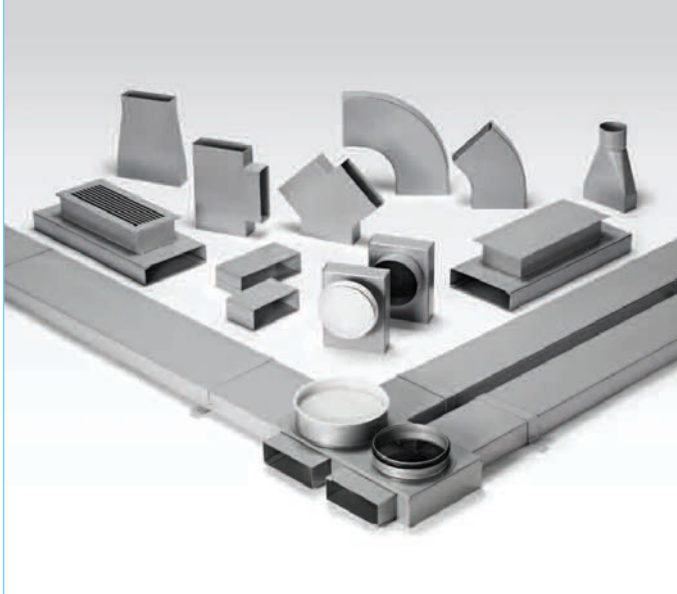

Underfloor-system made of galvanised steel; especially developed for room ventilation. The optimum solution for hidden air ducts, therefore perfectly suitable for new buildings.

■ Characteristics

- All parts made of galvanised steel, noncorrosive and non flammable.

■ Available in two sizes

- FK 150 x 50 mm for air flow volume up to 90 m³/h.
- FK 200 x 50 mm for air flow volume up to 140 m³/h.

■ Ducts conception and mounting

- Flat design and rigid construction allow a trouble-free laying on the floor screed.
- Connection via external connectors. Fittings with sockets (35 mm insertion). Therefore, the absolutely smooth inner surface ensures low air flow resistance and no barriers for dirt. However, disinfection is possible, if desired.
- The junction box for the supply air and extract air routing is installed on each floor which simplifies the duct routing.
- Special flat sound absorbers can be installed within the duct route to protect (e.g. bedrooms) from noise (FK-SD).

Flat duct

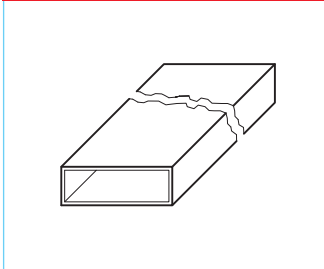

Type	Ref. no.	Dim in mm	Width	Height	Length
150 x 50 mm					
FK 150	2905	150	50	1500	
200 x 50 mm					
FK 200	2906	200	50	1500	

Elbow, horizontal 45°

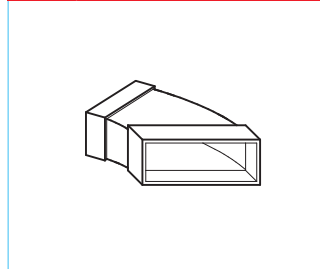

Type	Ref. no.	Dim in mm	Width	Height	Radius
150 x 50 mm					
FK-BH 150/45	2910	153	53	45°	
200 x 50 mm					
FK-BH 200/45	2912	203	53	45°	

Flat duct connector

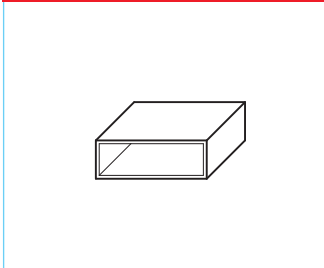

Type	Ref. no.	Dim in mm	Width	Height	Length
150 x 50 mm					
FK-V 150	2941	153	53	200	
200 x 50 mm					
FK-V 200	2942	203	53	200	

Elbow, vertical 90°

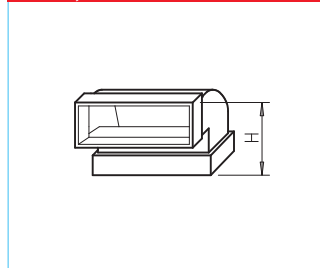

Type	Ref. no.	Dim in mm	Width	Height	Radius
150 x 50 mm					
FK-BV 150/90	2919	153	103	90°	
200 x 50 mm					
FK-BV 200/90	2920	203	103	90°	

Mounting bracket

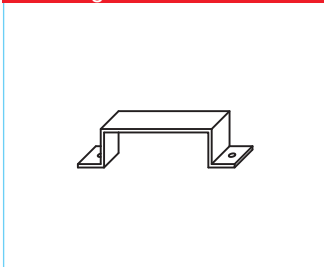

Type	Ref. no.	Dim in mm	Width	Height	Length
150 x 50 mm					
FK-B 150	2907	151	52	30	
200 x 50 mm					
FK-B 200	2908	201	52	30	

Elbow, vertical 45°

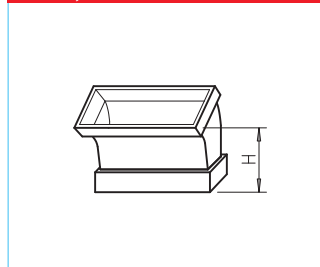

Type	Ref. no.	Dim in mm	Width	Height	Radius
150 x 50 mm					
FK-BV 150/45	2917	153	73	45°	
200 x 50 mm					
FK-BV 200/45	2918	203	73	45°	

Elbow, horizontal 90°

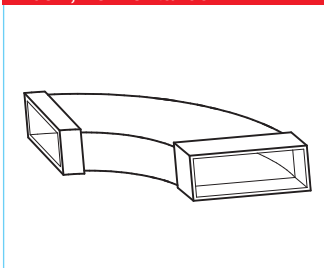

Type	Ref. no.	Dim in mm	Width	Height	Radius
150 x 50 mm					
FK-BH 150/90	2909	153	53	90°	
200 x 50 mm					
FK-BH 200/90	2911	203	53	90°	

Y-Branch

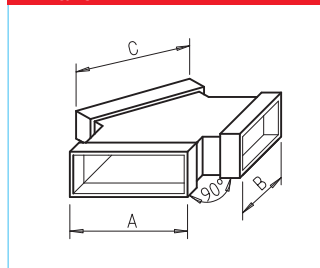

Type	Ref. no.	Dim in mm	A	B	C
150 x 50 mm					
FK-Y 150/150/150	2927	153	153	153	
200 x 50 mm					
FK-Y 200/150/150	2929	153	153	203	

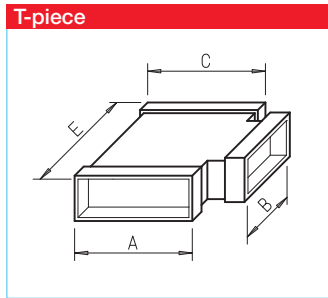

T-piece					
Type	Ref. no.	Dim. in mm			
		A	B	C	E
FK-T 150/150/150	2921	153	153	153	250
FK-T 150/150/200	2923	153	153	203	390
FK-T 150/200/150	2926	153	203	153	300
FK-T 200/150/200	2925	203	153	203	250
FK-T 150/200/200	2924	153	203	203	440
FK-T 200/200/200	2922	203	203	203	300

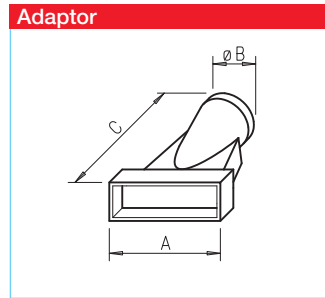

Adaptor				
Type	Ref. no.	Dim. in mm		
		A	Ø B	C
150 x 50 mm				
FK-Ü 75/150	2948	153	78	260
FK-Ü 100/150	2996	153	103	260
200 x 50 mm				
FK-Ü 100/200	2997	203	103	260
FK-Ü 125/200	2998	203	128	260

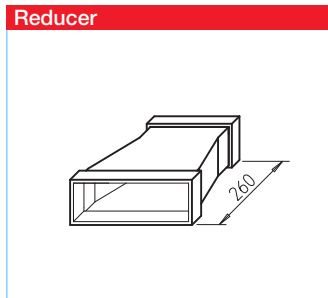

Reducer			
Type	Ref. no.	Dim. in mm	
		Length	Height
Reducer symmetric			
FK-RS 200/150	2932	260	53
Reducer asymmetric			
FK-RA 200/150	2933	260	53

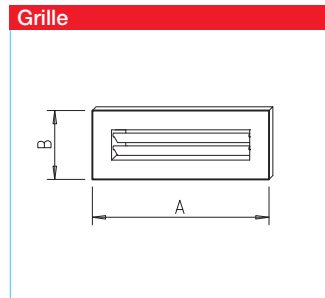

Wall and ceiling grill				
Type	Ref. no.	Colour	Dim. in mm	
			A	B
200 x 50 mm				
FK-WA 200 W	9350	white	250	103
FK-WA 200 AL	9351	alu	250	103

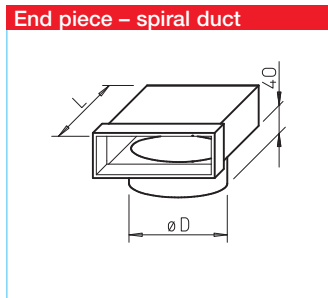

End piece with duct connector			
Type	Ref. no.	Dim. in mm	
		Ø D	L
150 x 50 mm			
FK-ER 150/100	2934	99	200
FK-ER 150/125	2935	124	200
200 x 50 mm			
FK-ER 200/160	2936	159	220

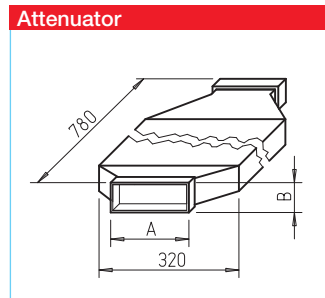

Attenuator			
Type	Ref. no.	Dim. in mm	
		A	B
150 x 50 mm			
FK-SD 150	2945	153	53
200 x 50 mm			
FK-SD 200	2946	203	53

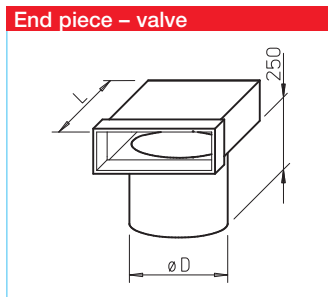

End piece with valve connector			
Type	Ref. no.	Dim. in mm	
		Ø D	L
150 x 50 mm			
FK-EV 150/100	2937	102	200
FK-EV 150/125	2938	127	200
200 x 50 mm			
FK-EV 200/100	2939	102	200
FK-EV 200/125	2940	127	200

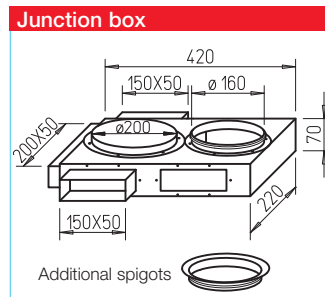

Junction box	
Type	Ref. no.
FK-VK	2987
Scope of delivery FK-VK	
4 spigots 150 x 50 (2 fixed, 2 loose),	
1 spigot 200 x 50 plus 1 revision shutter.	
Additional spigots for pass junction box	
FK-ZS	2947

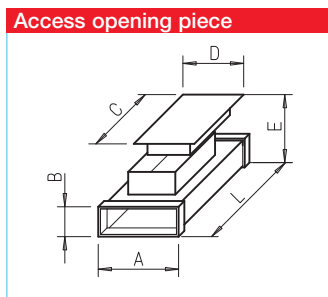

Access opening piece						
Type	Ref. no.	Dim. in mm				
		A	B	C	D	L
150 x 50 mm						
FK-RZ 150	2930	153	53	347	137	500
200 x 50 mm						
FK-RZ 200	2931	203	53	347	137	500

E can be adapted from 105-130 mm.

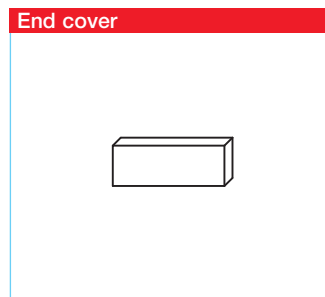

End cover	
Type	Ref. no.
150 x 50 mm	
FK-ED 150	2943
200 x 50 mm	
FK-ED 200	2944

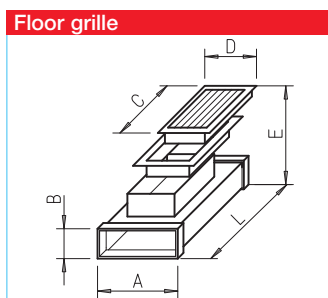

Aluminium floor grille with casing						
Type	Ref. no.	Dim. in mm				
		A	B	C	D	L
150 x 50 mm						
FK-BA 150	2986	153	53	348	152	500

E can be adapted from 112-152 mm.

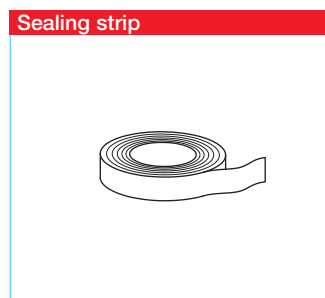

Sealing strip	
Type	Ref. no.
Cold shrinking strip	
KSB	9343 50 mm width 15 mtrs
Alu-cold shrinking strip	
KSB ALU	9344 50 mm width 15 mtrs
Strip	
KLB	0619 50 mm width 20 mtrs

Extract air elements



Design ventilation and poppet valves

For air extract with higher and lower air flow speeds and/or resistances, with compact and attractively designed fascia and integrated filter.

Supply air elements



Design ventilation and poppet valves

For air supply with higher and lower air flow speeds and/or resistances.

Type DLV 125 with compact and attractively designed fascia and integrated filter

Supply-extract-valve ZAV



Supply-extract-valve ZAV

Elegant polymer valve for wall and ceiling installation. Can be used as wall element with open front grille. Ceiling installation possible with closed front grille. Flexible use as supply or extract air valve possible.

Attachment filter element VFE



Attachment filter element VFE

Covers poppet valves in case of contaminated air. Prevents fat and dust deposits. Casing made from galvanised steel, white, powder coated. Filter made from aluminium with 324 cm² filter surface and aluminium frame.

Control line



Control line

Ribbon cable, on both sides with plugs RJ12 for slide switch controller KWL BE. On both sides with plugs RJ10 for comfort controller KWL-BEC, CO₂-, mixing gas (VOC), humidity sensor, KNX/EIB module or the extension module. For full details of accessory components see product pages KWL® units.

Adapter board

Adapter from ribbon cable to wires or cables. For connecting KNX module and RJ10 control line. Description KNX module see KWL® unit product pages.

Type KWL-RJ10 KL No. 4277

Ø 80		Ø 100		Ø 125		Ø 160	
Type	Ref. no.	Type	Ref. no.	Type	Ref. no.	Type	Ref. no.
Design valve DLV¹⁾ for extraction							
		DLV 100	3039	DLV 125	3049		
		ELF-DLV 100²⁾	3042	ELF-DLV 125²⁾	3058		

Polymer poppet valve KTVA							
KTVA 75/80	0940	KTVA 100	0941	KTVA 125	0942	KTVA 160	0943
Metal poppet valve for extraction (for areas, in which inflammable comp. are not prescribed)							
MTVA 75/80	8868	MTVA 100	8869	MTVA 125	8870	MTVA 160	8871

¹⁾ With integrated filter.

²⁾ Replacement air filters for DLV, SU = 5 pcs.

Ø 80		Ø 100		Ø 125		Ø 160	
Type	Ref. no.	Type	Ref. no.	Type	Ref. no.	Type	Ref. no.
Ventilation grille LGK, Design valve DLV for supply							
LGK 80	0259	DLVZ 100	3040	DLV 125	3049		
				ELF-DLV 125¹⁾	3058		

Polymer poppet valve KTVZ							
KTVZ 80	2762	KTVZ 100	2736	KTVZ 125	2737	KTVZ 160	2738
Metal poppet valve for supply (for areas, in which inflammable comp. are not prescribed)							
MTVZ 75/80	9603	MTVZ 100	9604	MTVZ 125	9605	MTVZ 160	9606

¹⁾ Replacement air filters for DLV 125, SU = 5 pcs.

Ø 80		Ø 100		Ø 125		Ø 160	
Type	Ref. no.	Type	Ref. no.	Type	Ref. no.	Type	Ref. no.
Polymer valve for supply and extract air ZAV							
ZAV 80	3079			ZAV 125	3080		

Type VFE 70 Ref. no. 2552

Type VFE 90 Ref. no. 2553

Type ELF/VFE Ref. no. 2554

Replacement air filters, SU = 2 pcs.

Cable length*	For KWL-BE (Ribbon cable on both sides with RJ12 plugs)		For KWL-BEC, -CO ₂ -, -VOC, -FTF, -KNX, -EM (Ribbon cable on both sides with RJ10 plugs)	
	Type	Ref. no.	Type	Ref. no.
3 m	KWL-SL 6/3	9987	KWL-SL 4/3	4404
5 m	KWL-SL 6/5	9980	KWL-SL 4/5	4405
10 m	KWL-SL 6/10	9444	KWL-SL 4/10	4411
20 m	KWL-SL 6/20	9959	KWL-SL 4/20	4413

* Other lengths on request.

Other accessories	Page
– Enthalpy heat exchanger	84 on
– HygroBox	116 on
– Undersoil heat exch.	118 on
– Insulated ducting syst.	122 on
– Air distrib. systems	126 on
– Fire prot. elements	516 on

Accessories details	Page
Dimensions, further technical information as well as other sizes:	
Water heater batteries and temp. control systems	431 on
Grilles, ducts, duct components, roof terminations	487 on
Extract air elements, attachment filter elements,	500 on
Valves	508 on

Shutters



Attenuators



Water heater battery

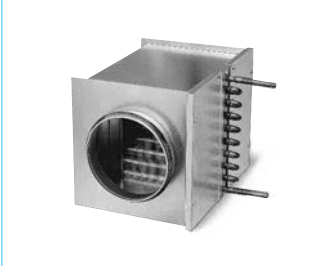

Ventilation door grille



Cleaning kit



Air temperature control system



Hydraulic unit



Ø 125	Ø 160	Ø 200	Ø 250	Ø 315	Ø 355	Ø 400	Ø 560								
Flanged flexible connector – For sound insulation, incl. 2 pcs. hose clamps															
—	—	FM 200	1670	FM 250	1672	FM 315	1674	FM 355	1675	FM 400	1676	FM 560	1679		
Back draught shutter – manual or automatic, in-line installation, casing made from galvanised sheet steel or *polymer															
RSKK* 125	5107	RSK 160	5669	RSK 200	5074	RVM** 250	2576	RVM** 315	2578	RVM** 355	2579	RVM** 400	2580	RVM** 560	2583
Lock cold smoke valves – For mains common in multi-storey buildings															
KAK 125	4098	KAK 160	4099	KAK 200	4100	—	—	—	—	—	—	—	—	—	
Flexible attenuator (FSD) or elastic silencer (SDE) – Aluminium duct				Circular attenuator (RSD) – Galv. sheet steel											
SDE 125	0789	SDE 160	0790	FSD 200	0679	FSD 250	0680	FSD 315	0681	FSD 355	0682	FSD 400	0683	—	
—	—	—	—	RSD 250	8739	RSD 315	8745	RSD 355	8748	RSD 400	8751	RSD 560	8759	—	

Type	Ref. no.	Suitable for pipe Ø mm	Air-side data					Water data ¹⁾		Weight kg	Suitable temperature control system	
			Heat power		Δ T air		at V	Pressure loss Δp _v kPa	at water flow rate l/h		Type	Ref. no.
WHR 100	9479	100	1.9	0.9	35	17	150	1	84	3.2	WHST 300 T50	8820
WHR 125	9480	125	2.6	1.1	29	13	250	2	115	3.2	WHST 300 T50	8820
WHR 160	9481	160	5.5	3.1	38	22	400	11	245	4.9	WHST 300 T50	8820
WHR 200	9482	200	7.2	4.1	33	19	600	17	317	4.9	WHST 300 T50	8820
WHR 250	9483	250	10.7	6	37	21	800	8	470	6.9	WHSH HE 24 V	8318
WHR 315	9484	315	18.3	10.4	36,2	21	1400	9	810	9.0	WHSH HE 24 V	8318
WHR 400	9524	400	26.2	15	36	21	2000	11	1060	12.5	WHSH HE 24 V	8318

Ventilation door grille
Unobtrusive, opaque ventilation grille break-proof polymer for installation in door panel.

Detailed description see product page.

Type LTGW Ref. no. 0246
Polymer, white.

Type LTGB Ref. no. 0247
Polymer, brown.

Cleaning kit for distribution systems FlexPipe® and RenoPipe
The universal cleaning kit is perfect for cleaning of the flexible ducting system FlexPipe® (DN 75, DN 63) as well as the RenoPipe air distribution system (DN 100). Application is optionally under pressure (with short ways) or tension possible. With longer ducting distances or narrow elbows the nylon wheel brush is pulled simply

Cleaning kit toward the distribution box, at which the 90° elbow is used for the vacuum connection. Via this, the dust particles dislodged by the nylon wheel brush are vacuumed without problems with a commercial vacuum cleaner.

Delivery in practical transportation bag.
Scope of delivery: 1 piece of each
– Hand reel with flexible glass fibre reinforced wire (20 running mtrs)
– Wheel brush DN 63, 75, 100
– 90° elbow and sealing for vacuum connection DN 56
– Adapter DN 56/40, DN 56/32.

Type KWL-RS Ref. no. 2797

Air temperature control system for KWL® units with PWW heater battery.
KWL WW types with integrated PWW water heater battery. Consisting of thermostat with remote control and remote sensor. Simple, low-cost and quick assembly solution. Temperature range 8 – 38 °C.
WHST 300 T38 Ref. no. 8817



Air temperature control system for warm water battery WHR. Ideal for application as supply air heating.
Consisting of thermostat incl. duct temperature sensor (with 2 m capillary tube) and valve. Enables a constant supply air temperature. Simple, low-cost and quick assembly solution. Temperature range 20 – 50 °C.
WHST 300 T50 Ref. no. 8820

Hydraulic unit
Controls the flow of the water heater battery by means of three point valve actuator 24 V (0-10 V) and in this way the thermal output which is conveyed to the air. Delivered as complete unit, including flow-/return water temperature display, circulation pump and flexible connecting pipes.
WHSH HE 24 V (0-10 V) No. 8318



Clock timer
Digital with LCD-display or the automatic control of the operation, all days of the week can be programmed. For surface and flush mounting.
Dim. mm (WxHxD) 85 x 85 x 52
Type WSUP Ref. no. 9990
For switchboard installation (2 space units required).
Dim. mm (WxHxD) 36 x 90 x 69
Type WSUP-S Ref. no. 9577

WHR: The above values apply for an intake temperature of 0 °C and flow/return water temperature: ¹⁾ 90/70 °C, ²⁾ 60/40 °C.

Helios expertise in aerodynamics.
Axial fans without limits.

As one of the leading European fan manufacturers, Helios impresses with extraordinarily large, finely graduated range of high-performance axial, medium-pressure and RADAX® VAR high-pressure fans in all performance ranges.

The next pages present the range for high-performance axial fans with aerodynamic and acoustically optimised impeller and an innovative motor concept (diameter of 250 to 500 mm).

The particularly energy-saving EC models achieve energy savings of over 55% in comparison to conventional AC types thanks to their speed controls.

The AC high-performance axial fans with diameters of 250 to 500 mm and voltage control have an impressive, tried-and-tested and robust design and increase efficiency by 25% while reducing noise by 50%.

The range with diameters of up to 1000 mm is supplemented by solutions for the area of technical building equipment (TGA), see the right hand side.

- Fire gases and smoke extraction types in accordance with DIN 12101-3 in temperature classes F300 (60 minutes), F400 (120 minutes) and F600 (120 minutes). See separate catalogue.
- Specialist solutions for technical building equipment (TGA) and large axial fans with diameters from 1000 to 7100 mm, volumes of up to 2.2 million m³/h can be produced in accordance with customer-specific requirements. See www.AxialSoft.de for the design.



**HIGH-PERFORMANCE
AXIAL FANS**
Product-specific information
and selection chart

Energy-efficient
EC version
Ø 250 – 500 mm
V = 1930 – 8300 m³/h

Standard
AC version
Ø 200 – 1000 mm
V = 520 – 63 420 m³/h

140

142^{on}

154^{on}

Well-known users from all over the world trust Helios axial fans for ventilation, heating, cooling and drying applications. Large fans have been used successfully for decades e.g. in cooling towers and condensers.

**MEDIUM PRESSURE
AXIAL FANS**
Product-specific information
and selection chart

**RADAX® VAR
HIGH-PRESSURE FANS**
Product-specific information
and selection chart

**INSTALLATION
ACCESSORIES**
For axial and RADAX® VAR
in-line fans



Ø 225 – 630 mm
V = 950 – 26 450 m³/h



Ø 225 – 630 mm
V = 900 – 22 310 m³/h

180^{on}

206^{on}

231^{on}

The following information completes the “General Technical Information” section.

Types

- Helios offer a wide range of products for various applications, i.e. particular help for problem solutions.
- Standard and high-performance fans in industrial design are available as standard in more than 20 standard sizes and more than 1000 types; many of which are shown in this catalogue.
- Closely matched air flow volume and pressure can be achieved on larger fans with a maximum diameter of 7100 mm through adjustable pitch angle. Four standard casing types are available.
- Types HQ, HW and HRF are available up to standard size 500 mm with highly-efficient EC motor technology for particularly energy-saving application and lowest operating costs.

Types in this catalogue

1. Wall fan HQ

Square plate with inlet cone

Casing made from galvanised sheet steel. Motor with terminal box and motor side guard.

2. Built-in fans

HW, AVD DK

Circular plate with inlet cone

Casing made from galvanised sheet steel. Motor with terminal box and motor side guard.

3. Built-in wall fan HS

Cylindrical duct case with spigot ends

For flush, wall or in-line duct installation. Casing made from galvanised sheet steel with circular stiffening rings.

4. In-line fans

HRF, AVD RK

Cylindrical duct with flanges on both ends

For direct in-line installation in ducting. Flanges made to DIN 24155, PT. 3. Casing made from galvanised sheet steel, additional terminal box (IP 55) on outer casing.

Motor

- AC types
Robust 1 ph. or 3 ph. internal rotor motor with thermal contacts in the windings. Ball bearings lubricated for life.
- EC types
Highly-efficient, speed controllable external rotor motor protected to IP 44 or 54. Ball bearings lubricated for life.

Impellers

- Depending on the performance requirements the impellers are made from various materials; see product pages. The standard design is made from reinforced polymers. Other materials, aluminium or steel, are available on special order.
- All impellers feature:
 - Low noise characteristics.
 - High efficiency.
 - Vibration free operation due to dynamic balancing to DIN ISO 1940 T.1 – grade 6.3.
- Impellers made from other materials are available upon request.
- The standard models are suitable for air flow temperature from –30° to +60 °C. For higher temperatures metal impellers are available to order. See information on the product pages.

Pitch angle

- The standard products up to 630 mm Ø are equipped with fixed impeller blades.
- Starting from nominal size 710 mm (except type HQW 710/6), the impeller blades are available with order related pitch angles.
- The installation sizes Ø 800/4, 900/4 and ..6 as well as Ø 1000 mm have adjustable blades at standstill. This enables the fan to provide the exact duty required. The pitch angle is factory set (must be stated when ordering). The motors are selected using their maximum performance (see table on product page). The maximum pitch angle shown must not be exceeded as the motor will be overloaded.

Air flow direction

- All fans (except HRF and AVD RK) come with the air flow direction
- A = pulling air over the motor** as standard. Air flow direction **B = pushing air over the motor** is available for most models with an additional charge. HRF and AVD RK come with air flow direction B as standard.
- The air flow direction can be changed after supply, should it be required, for most AC high-performance axial fans. To do so you have to:
 1. Change the direction of rotation of the motor by changing the terminals on the terminal board.
 2. Remove impeller and put it the opposite way round on the shaft (possible up to Ø 500). Models HQ and HW allow for a 1/3 drop in performance.
 - EC types can only be operated in the set standard direction of rotation.

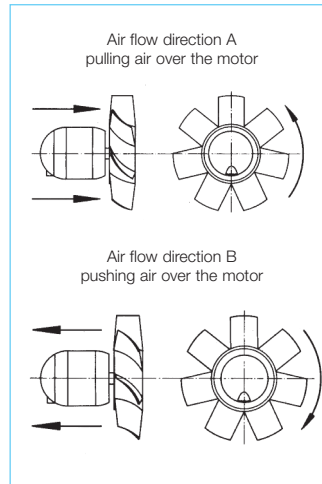

Protection against contact

All relevant safety instructions and regulations must be followed when the fans are installed. A protection against accidental contact to VDE 0700 and/or DIN EN ISO 13857 must be guaranteed. The contact with rotating parts must be avoided. Make sure that there are no items near the inlet which could be pulled into the fan. Fans which are protected when installed (e.g. in ventilation ducting or closed aggregate) do not require a guard if the system provides sufficient safety. We emphasise that the installer is responsible for the safety of the installation by fitting appropriate protection devices. Suitable guards are available as accessories. The responsibility that all relevant regulations have been observed remains with the installer.

Position, installation, drainage holes

- Axial fans are suitable for installation in any position. If condensation is to be expected, (e.g. for intermittent operation, high humidity air flow or rapidly changing temperatures) the fan must be installed with the motor drainage holes facing downward and they must be open.
- If installed outdoors, or in wet conditions or if installed with the motor shaft facing vertically upwards, this must be stated when ordering. Please make sure that the fan is fixed securely and the casing is not squeezed or distorted.

Reverse operation

- Most axial fans are reversible (see product page). Using a suitable reversing switch. The fan can be used for intake or extract. In abnormal direction of flow the capacity decreases by approx. 1/3.
- EC types are not reversible as standard.

Air flow temperatures

The standard models are suitable for temperatures from –30 °C to +40 °C or +60 °C (AC or EC types). Apart from explosion proof fans, higher temperatures are possible for a short time. For permanently higher temperatures special models are available on request.

Motor protection

- For AC types; through thermal contacts in the windings
 - standard for 1 ph. motors,
 - mostly standard for 3 ph. motors (see product page).
- For EC types; integrated electronic temperature monitoring.

Explosion protection

The ex-proof models conform to cluster II, category 2G for operation in zone 1 or 2. According to directive 2014/34/EU (ATEX), larger air gaps are specified which lead to a capacity reduction of up to 10%.

Extra equipment, additional charge on demand

- Aluminium cast impeller
- Alternative voltage
- Alternative frequency
- Two pack coating for protection of external components against diluted acids and lime solutions
- Alternative air flow direction
- Extra equipment for higher air flow temperatures
- Pressure-tight encapsulated motors (standard for 1 ph. ex-proof types)

Anti vibration insulation

To avoid vibration transmission to building and ducting the use of anti vibration mounts (accessory SDD, SDZ) is highly recommended. Larger frame size motors may protrude out of the casing and might move the centre of gravity within the fan. To avoid an uneven load on the anti vibration mounts, an extension duct is recommended (accessory VR).

By combining the parameters of static pressure increase Δp_{st} , air flow volume V , speed min^{-1} , sound pressure level dB(A) and impeller diameter DN mm, the following table facilitates the selection of EC high-performance

axial fans \varnothing 250 to 500 mm and high-performance axial fans \varnothing 200 to 1000 mm.

Diameter	R.P.M.	Sound press. Intake L_{PA} dB(A)	Air flow volume $V \text{ m}^3/\text{h}$ depending on static pressure																
			(ΔP_{st}) in Pa																
			in 4 m	0	10	20	30	40	50	60	80	100	120	140	160	200	250	300	350
EC 250	2300	56	1930	1880	1820	1760	1700	1630	1550	1370	1070								
EC 315	1650	52	3110	3000	2880	2760	2640	2520	2400	2090	1680								
EC 355 A	1200	50	3220	3050	2870	2700	2520	2330	2090										
EC 355 B	1975	59	4200	4150	4090	4020	3960	3890	3820	3690	3540	3360	3100	2790					
EC 400 A	1800	59	4790	4690	4610	4540	4460	4390	4310	4140	3920	3640	3240						
EC 400 B	2150	65	5850	5800	5760	5700	5640	5560	5490	5360	5210	5080	4870	4730	4030				
EC 450 A	1325	55	5460	5350	5250	5140	5030	4910	4790	4520	4200	3730							
EC 450 B	1835	64	7640	7580	7510	7450	7390	7330	7260	7070	6880	6680	6490	6200	5530				
EC 500 A	1025	54	6320	6190	6050	5900	5750	5590	5420	5010	4460								
EC 500 B	1450	62	8300	8230	8150	8070	7970	7880	7790	7490	7300	6910	6530	6140					

Diameter	R.P.M.	Sound press. Intake L_{PA} dB(A)	Air flow volume $V \text{ m}^3/\text{h}$ depending on static pressure																
			(ΔP_{st}) in Pa																
			in 4 m	0	10	20	30	40	50	60	80	100	120	140	160	200	250	300	350
200	2300	55	910	860	810	760	710	490	420	330	220								
200	1360	42	520	410	210	170													
250	2800	53	2070	2040	2010	1970	1940	1910	1870	1800	1710	1610	1480						
250	1450	44	930	840	730														
250	950	31	660	570															
315	2800	69	4090	4050	4020	3990	3950	3920	3880	3790	3700	3610	3500	3380	3090				
315	1450	51	2090	2010	1930	1840	1740	1620	1410										
315	950	38	1330	1220	1070														
315	725	30	980	780															
355	2800	71	5710	5670	5620	5580	5530	5480	5430	5330	5220	5110	4990	4860	4550	4020			
355	1450	51	2850	2770	2670	2570	2450	2320	2160										
355	950	42	1940	1830	1690	1500	1060												
355	725	34	1430	1240	880														
400	2800	71	8410	8360	8310	8270	8220	8170	8130	8030	7940	7840	7750	7650	7440	7160	6840	6440	5820
400	1450	56	4010	3920	3810	3700	3580	3440	3300	2970									
400	950	45	2570	2410	2230	2020													
400	725	37	2010	1810	1530														
450	2800	78	11050	10960	10870	10770	10680	10590	10500	10310	10130	9950	9770	9580	9210	8690	8050	6930	4520
450	1450	58	5770	5680	5590	5500	5390	5280	5160	4870	4510	4010							
450	950	47	3890	3720	3550	3360	3150	2890											
450	725	51	2860	2680	2450	2120													
500	2800	81	13150	13040	12930	12820	12720	12610	12500	12290	12070	11860	11660	11440	11010	10380	9600	8620	5390
500	1450	65	8320	8220	8110	8000	7880	7760	7630	7370	7080	6760	6400	5970					
500	950	51	5500	5330	5140	4950	4740	4510	4240	3450									
500	725	44	3890	3690	3440	3150	2750												
560	1450	62	12910	12680	12550	12360	12140	11950	11770	11320	10900	10550	10000	9500	8270				
560	950	52	8100	7680	7370	7080	6680	6280	5830	4570									
560	725	46	6450	6070	5640	5230	4750	4140											
630	1450	65	17870	17650	17420	17200	16970	16750	16520	16010	15500	15000	14500	14000	13000	11300			
630	950	55	10520	10150	9780	9410	9040	8670	8220	7260									
630	725	49	8000	7580	7010	6530	5910	5300											
710	1450	71	23740	23490	23240	22980	22730	22470	22200	21660	21090	20500	19900	19290	18010	16240	14000	11060	
710	935	61	15250	14860	14450	14040	13590	13140	12600	11690	10610	9280	7440						
710	700	54	11350	10810	10250	9630	8990	8300	7500	5340									
800	1435	73	32350	32040	31720	31400	31090	30770	30490	29860	29230	28610	27990	27330	25940	24020	22080		
800	945	62	20720	20280	19830	19350	18850	18290	17710	16530	15330	13840	10740						
800	705	55	15380	14780	14120	13380	12580	11790	10900										
900	1435	76	46060	45700	45390	45030	44670	44310	44000	43280	42600	41880	41170	40800	39060	37110	34940	32800	30340
900	950	66	30500	30100	29500	29100	28500	27900	27400	26300	25100	23910	22710	21310					
900	725	59	21160	20410	19640	18850	18010	17120	16130	15000									
1000	1440	80	63420	63030	62650	62260	61870	61490	61110	60330	59560	58790	58010	57240	55700	53710	51590	49260	46830
1000	950	69	41740	41150	40570	39990	39400	38810	38230	37060	35870	34610	33260	31810	28880				
1000	725	62	31760	30990	30220	29460	28690	27930	27130	25410	23500	21540							

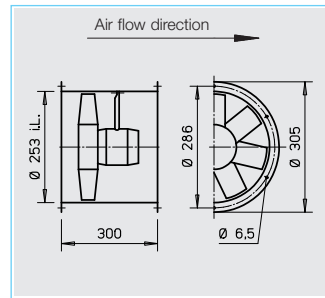
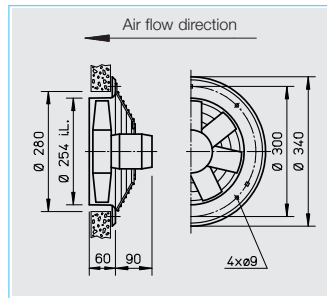
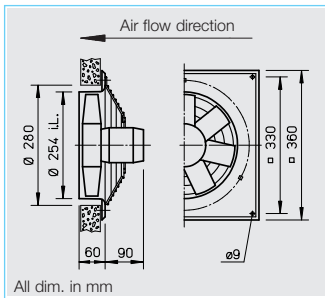

■ Specification for all types

□ Casing

Manufactured in galvanised sheet steel. Models HQ and HW have the additional protection of two coats of papyrus white.

□ Impeller

Highly efficient with profiled polymer blades, aerodynamically optimised for application, dynamically balanced. Operating range from -30 to +60 °C.

□ Motor

Energy-saving, speed-controllable EC external rotor motor protected to IP 44 with high level of efficiency. Maintenance-free and interference-free, excellent electromagnetic compatibility (EMC), ball bearing mounted.

□ Motor protection

Integrated electronic temperature monitoring for EC motor and electronics.

□ Electrical connection

Standard terminal box (protection to IP 54) mounted to running cable and on the outside of the ducting for HRF.

□ Guard

Made from powder-coated steel for HQ and HW, in accordance with DIN EN ISO 13857.

□ Speed control

All types are steplessly controllable through the speed-potentiometer. Furthermore, control is also possible via three-step switch or steplessly via universal control system or electronic differential pressure/temperature controller. See table below. The example performance stages are shown in the characteristic curves.

□ Installation

Installation in any position.

□ Sound levels

Sum levels and spectrum figures for sound power and sound pressure levels in 4 m free field conditions are specified above the characteristic curve for a medium intake/exhaust operating point. The sound pressure sum level in 4 m (free field conditions) is also shown in the table below and the table below the characteristic curve for different voltages. Sound emissions and room acoustics see page 10.

R.P.M.	Air flow volume (FID)	Motor power	Current	Sound pressure	Wiring diagram	max. air flow temperature	Weight net approx.	Type					
								HQ EC incl. guard	Ref. no.	HW EC incl. guard	Ref. no.	HRF EC	Ref. no.
min ⁻¹	V m ³ /h	kW	A	dB(A) in 4 m	No.	+°C	kg						
1 ph. motor, 1~ 230 Volt, 50/60 Hz, EC motor, protection to IP 44													
2650	1930	0.13	0.97	56	1046	40	6.5	HQW EC 250 A	4822	HWW EC 250 A	4823	HRFW EC 250 A	4824

250 A

Frequency	Hz	Total	125	250	500	1k	2k	4k	8k
L _{WA} Air noise	dB(A)	76	47	67	70	69	70	67	60
L _{PA, 4m} Air noise	dB(A)	56	27	46	50	49	50	47	40

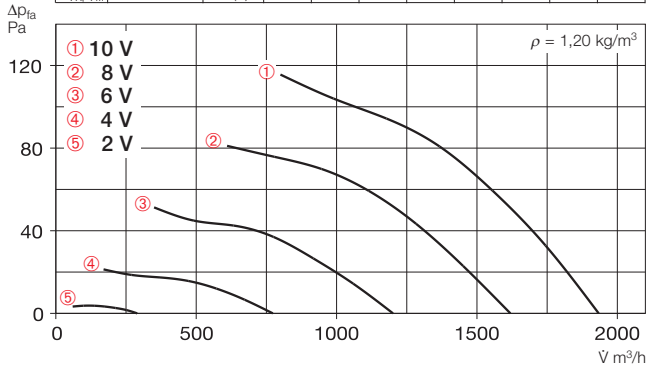

Voltage V	n min ⁻¹	Free discharge V_dot m³/h	P _{el} (W)	I _{Motor} (A)	L _{PA, 4m}
10	2650	1930	127	0,97	56
8	2230	1620	77	0,62	52
6	1670	1200	40	0,30	46
4	1090	770	15	0,14	37

Accessories for HRF EC Description see page 231 on

Bell mouth + guard ASD-SGD 250 No. 1414
Extension duct VR 250 No. 1402
Circular attenuator RSD 250/..
Automatic backdraught shutter RVS 250^{a)} No. 2592
Flanged flex. connector STS 250 No. 1220
Counter-flange FR 250 No. 1203
Flat flange FF 250 No. 4941
Flexible sleeve FM 250 No. 1672
Guard SG 250 No. 1236
2 mounting feet 1 x MK 250 (= 2 pcs.) No. 1447
4 anti-vibration mounts for suspension 1 x SDZ 1 (= 4 pcs.) No. 1454
4 anti-vibration mounts for compression 1 x SDD 1 (= 4 pcs.) No. 1452

^{a)} Motorised backdraught shutter see Accessories product pages

Information	Page
Techn. description	140
Selection chart	141
Information for planning	10 on

Made to order designs
 Alternative voltages, protection classes, air flow direction, air flow temperature, acid protection and cast aluminium impellers are available on request.

Note the technical information on page 15 on.

Other accessories	Page
Filters and attenuators	421 on
Backdraught shutters and grilles	487 on
Universal control system, electronic controller, speed-potentiometer	539 on

Universal control system		Speed-potentiometer flush		Three-step speed switch surface		Electronic diff. pressure controller/switch		Electronic temperature controller/switch					
Type	Ref. no.	Type	Ref. no.	Type	Ref. no.	Type	Ref. no.	Type	Ref. no.				
EUR EC ¹⁾	1347	PU 10 ¹⁾	1734	PA 10 ¹⁾	1735	SU-3 10 ¹⁾	4266	SA-3 10 ¹⁾	4267	EDR ¹⁾	1437	ETR ¹⁾	1438

¹⁾ Several EC fans can normally be connected, see Accessories

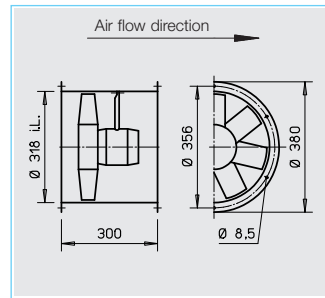
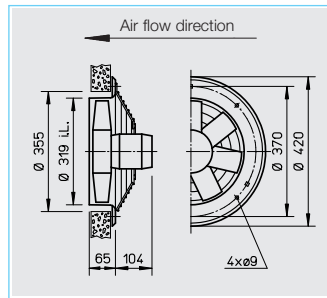
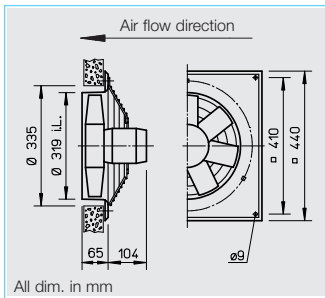

All dim. in mm

■ Specification for all types

□ Casing

Manufactured in galvanised sheet steel. Models HQ and HW have the additional protection of two coats of papyrus white.

□ Impeller

Highly efficient with profiled polymer blades, aerodynamically optimised for application, dynamically balanced. Operating range from -30 to +60 °C.

□ Motor

Energy-saving, speed-controllable EC external rotor motor protected to IP 44 with high level of efficiency. Maintenance-free and interference-free, excellent electromagnetic compatibility (EMC), ball bearing mounted.

□ Motor protection

Integrated electronic temperature monitoring for EC motor and electronics.

□ Electrical connection

Standard terminal box (protection to IP 54) mounted to running cable and on the outside of the ducting for HRF.

□ Guard

Made from powder-coated steel for HQ and HW, in accordance with DIN EN ISO 13857.

□ Speed control

All types are steplessly controllable through the speed-potentiometer. Furthermore, control is also possible via three-step switch or steplessly via universal control system or electronic differential pressure/temperature controller. See table below. The example performance stages are shown in the characteristic curves.

□ Installation

Installation in any position.

□ Sound levels

Sum levels and spectrum figures for sound power and sound pressure levels in 4 m free field conditions are specified above the characteristic curve for a medium intake/exhaust operating point. The sound pressure sum level in 4 m (free field conditions) is also shown in the table below and the table below the characteristic curve for different voltages. Sound emissions and room acoustics see page 10.

R.P.M.	Air flow volume (FID)	Motor power	Current	Sound pressure	Wiring diagram	max. air flow temperature	Weight net approx.	Type					
								HQ EC incl. guard	Ref. no.	HW EC incl. guard	Ref. no.	HRF EC	Ref. no.
min ⁻¹	V m ³ /h	kW	A	dB(A) in 4 m	No.	+°C	kg						
1 ph. motor, 1~ 230 Volt, 50/60 Hz, EC motor, protection to IP 44													
2040	3110	0.19	1.50	52	1046	40	8.0	HQW EC 315 A	4880	HWW EC 315 A	4881	HRFW EC 315 A	4882

315 A

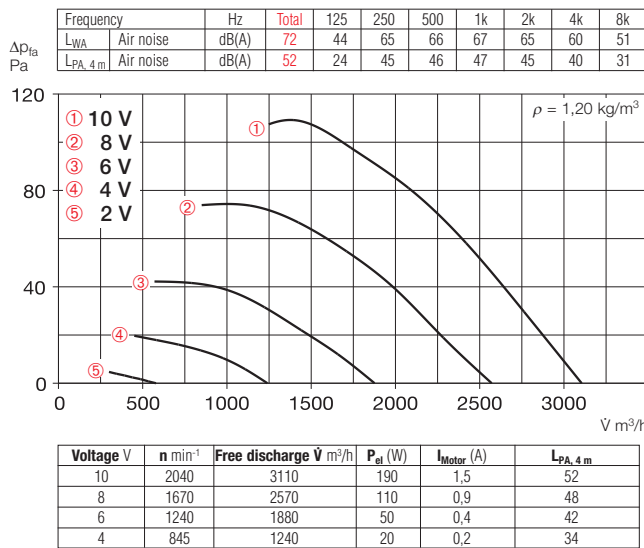

Accessories for HRF EC Description see page 231 on

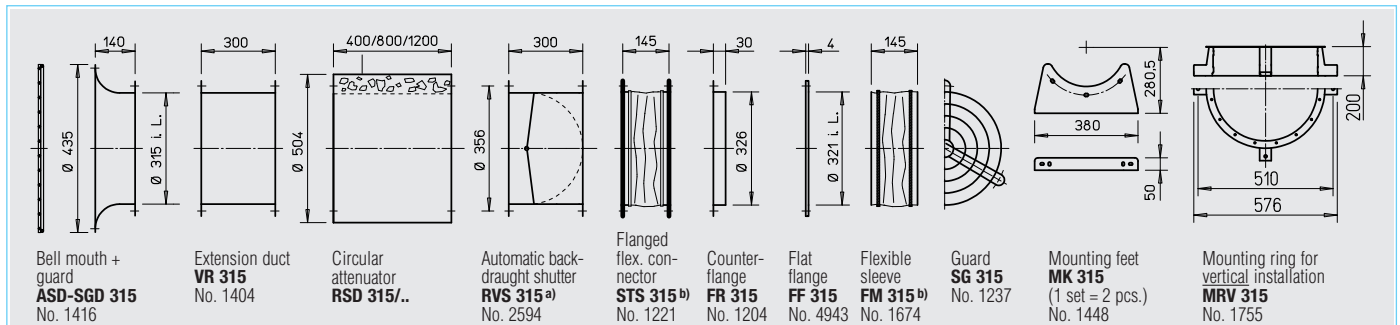

^{a)} Motorised backdraught shutter see Accessories product pages

Information	Page
Techn. description	140
Selection chart	141
Information for planning	10 on

Made to order designs
Alternative voltages, protection classes, air flow direction, air flow temperature, acid protection and cast aluminium impellers are available on request.

Note the technical information on page 15 on.

Other accessories	Page
Filters and attenuators	421 on
Backdraught shutters and grilles	487 on
Universal control system, electronic controller, speed-potentiometer	539 on

Universal control system		Speed-potentiometer flush		Three-step speed switch surface		Electronic diff. pressure controller/switch		Electronic temperature controller/switch					
Type	Ref. no.	Type	Ref. no.	Type	Ref. no.	Type	Ref. no.	Type	Ref. no.				
EUR EC ¹⁾	1347	PU 10 ¹⁾	1734	PA 10 ¹⁾	1735	SU-3 10 ¹⁾	4266	SA-3 10 ¹⁾	4267	EDR ¹⁾	1437	ETR ¹⁾	1438

¹⁾ Several EC fans can normally be connected, see Accessories

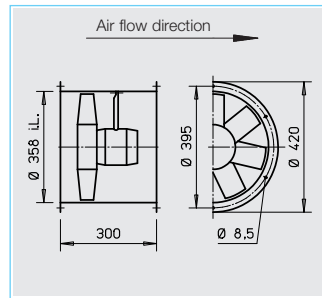
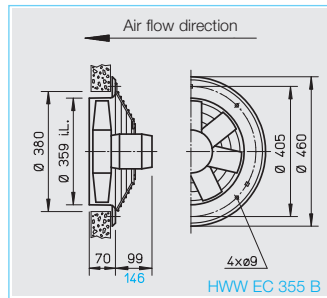
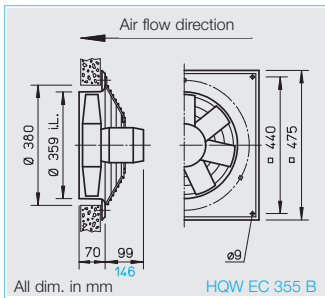

■ Specification for all types

□ Casing

Manufactured in galvanised sheet steel. Models HQ and HW have the additional protection of two coats of papyrus white.

□ Impeller

Highly efficient with profiled polymer blades, aerodynamically optimised for application, dynamically balanced. Operating range from -30 to +60 °C.

□ Motor

Energy-saving, speed-controllable EC external rotor motor protected to IP 44 (type A), IP 54 (Type B) with high level of efficiency. Maintenance-free and interference-free, excellent electromagnetic compatibility (EMC), ball bearing mounted.

□ Motor protection

Integrated electronic temperature monitoring for EC motor and electronics.

□ Electrical connection

Standard terminal box (protection to IP 54) For HQ and HW types mounted to running cable ("A") or on the back of the motor ("B"). For HRF types on the outside of the ducting.

□ Guard

Made from powder-coated steel for HQ and HW, in accordance with DIN EN ISO 13857.

□ Speed control

All types are steplessly controllable through the speed-potentiometer. Furthermore, control is also possible via three-step switch or steplessly via universal control system or electronic differential pressure/temperature controller. See table below. the example performance stages are shown in the characteristic curves.

□ Installation

Installation in any position.

□ Sound levels

Sum levels and spectrum figures for sound power and sound pressure levels in 4 m free field conditions are specified above the characteristic curve for a medium intake/exhaust operating point. The sound pressure sum level in 4 m (free field conditions) is also shown in the table below and the table below the characteristic curve for different voltages. Sound emissions and room acoustics see page 10.

R.P.M.	Air flow volume (FID)	Motor power	Current	Sound pressure	Wiring diagram	max. air flow temperature	Weight net approx.	Type					
								HQ EC incl. guard	Ref. no.	HW EC incl. guard	Ref. no.	HRF EC	Ref. no.
min ⁻¹	V m ³ /h	kW	A	dB(A) in 4 m	No.	+°C	kg						
1 ph. motor, 1~ 230 Volt, 50/60 Hz, EC motor, protection to IP 44													
1500	3220	0.15	1.20	50	1046	40	9.0	HQW EC 355 A	4916	HWW EC 355 A	4917	HRFW EC 355 A	4918
1980	4200	0.32	1.40	59	1047	40	12.0	HQW EC 355 B	4919	HWW EC 355 B	4920	HRFW EC 355 B	4921

355 A

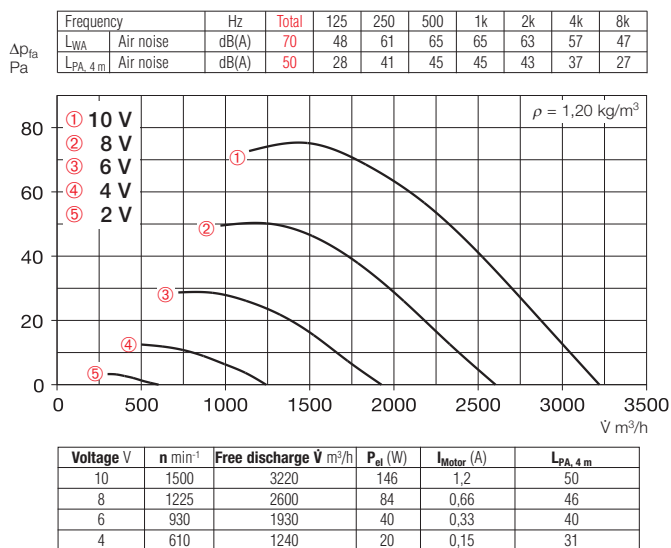

355 B

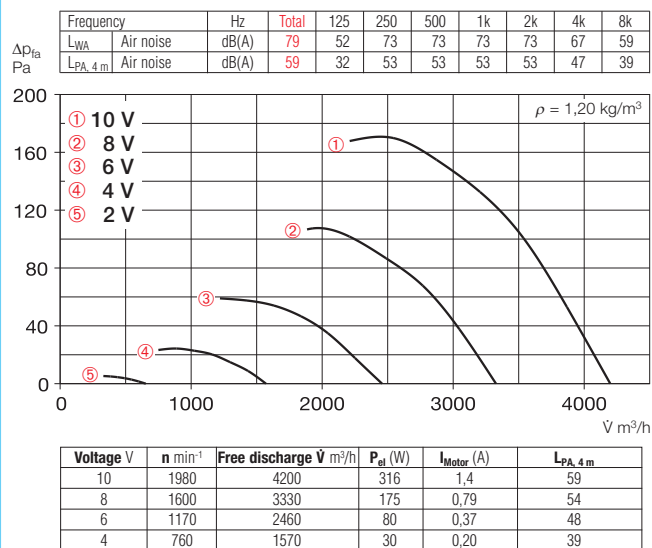

Accessories for HRF EC Description see page 231 on

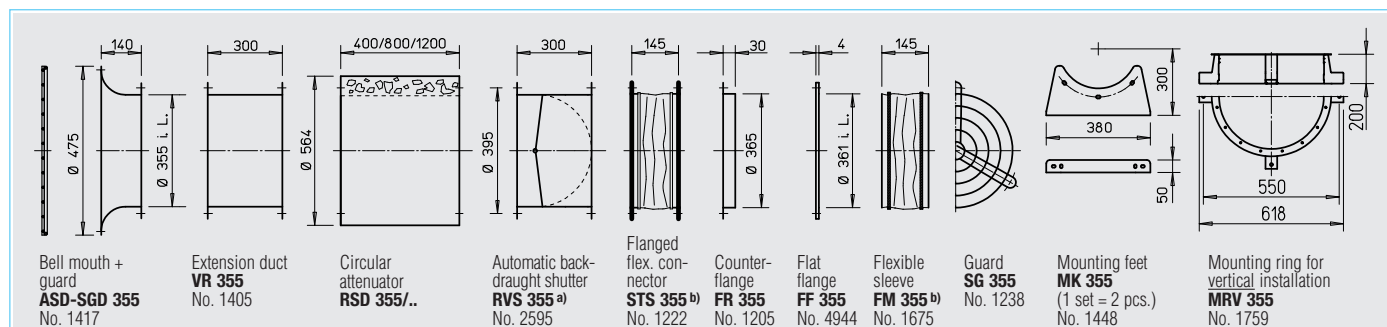

^{a)} Motorised backdraught shutter see Accessories product pages

Information	Page
Techn. description	140
Selection chart	141
Information for planning	10 on

Made to order designs

Alternative voltages, protection classes, air flow direction, air flow temperature, acid protection and cast aluminium impellers are available on request.

Note the technical information on page 15 on.

Other accessories	Page
Filters and attenuators	421 on
Backdraught shutters and grilles	487 on
Universal control system, electronic controller, speed-potentiometer	539 on

Universal control system		Speed-potentiometer flush		Three-step speed switch flush		Electronic diff. pressure controller/switch		Electronic temperature controller/switch					
Type	Ref. no.	Type	Ref. no.	Type	Ref. no.	Type	Ref. no.	Type	Ref. no.				
EUR EC ¹⁾	1347	PU 10 ¹⁾	1734	PA 10 ¹⁾	1735	SU-3 10 ¹⁾	4266	SA-3 10 ¹⁾	4267	EDR ¹⁾	1437	ETR ¹⁾	1438
EUR EC ¹⁾	1347	PU 10 ¹⁾	1734	PA 10 ¹⁾	1735	SU-3 10 ¹⁾	4266	SA-3 10 ¹⁾	4267	EDR ¹⁾	1437	ETR ¹⁾	1438

¹⁾ Several EC fans can normally be connected, see Accessories

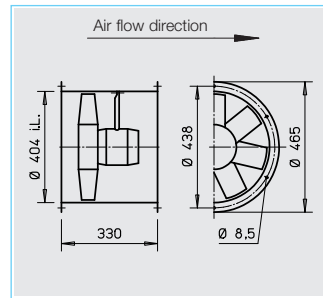
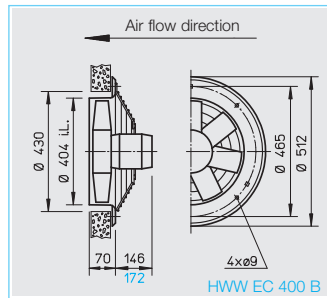
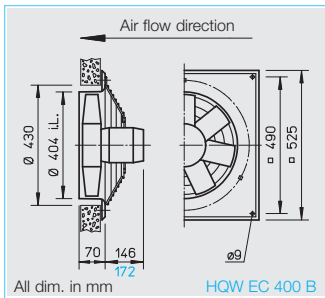

■ Specification for all types

□ Casing

Manufactured in galvanised sheet steel. Models HQ and HW have the additional protection of two coats of papyrus white.

□ Impeller

Highly efficient with profiled polymer blades, aerodynamically optimised for application, dynamically balanced. Operating range from -30 to +60 °C.

□ Motor

Energy-saving, speed-controllable EC external rotor motor protected to IP 54 with high level of efficiency. Maintenance-free and interference-free, excellent electromagnetic compatibility (EMC), ball bearing mounted.

□ Motor protection

Integrated electronic temperature monitoring for EC motor and electronics.

□ Electrical connection

Standard terminal box (protection to IP 54) For HQ and HW types mounted to running cable ("A") or on the back of the motor ("B"). For HRF types on the outside of the ducting.

□ Guard

Made from powder-coated steel for HQ and HW, in accordance with DIN EN ISO 13857.

□ Speed control

All types are steplessly controllable through the speed-potentiometer. Furthermore, control is also possible via three-step switch or steplessly via universal control system or electronic differential pressure/temperature controller. See table below. The example performance stages are shown in the characteristic curves.

□ Installation

Installation in any position.

□ Sound levels

Sum levels and spectrum figures for sound power and sound pressure levels in 4 m free field conditions are specified above the characteristic curve for a medium intake/exhaust operating point. The sound pressure sum level in 4 m (free field conditions) is also shown in the table below and the table below the characteristic curve for different voltages. Sound emissions and room acoustics see page 10.

R.P.M.	Air flow volume (FID)	Motor power	Current	Sound pressure	Wiring diagram	max. air flow temperature	Weight net approx.	Type						
								HQ EC incl. guard	Ref. no.	HW EC incl. guard	Ref. no.	HRF EC	Ref. no.	
min ⁻¹	V m ³ /h	kW	A	dB(A) in 4 m	No.	+°C	kg							
1 ph. motor, 1~ 230 Volt, 50/60 Hz, EC motor, protection to IP 54														
1700	4790	0.32	1.40	59	1047	40	13.4	HQW EC 400 A	4922	HWW EC 400 A	4923	HRFW EC 400 A	4924	
2150	5850	0.65	3.10	65	1048	40	15.4	HQW EC 400 B	4925	HWW EC 400 B	4926	HRFW EC 400 B	4927	

400 A

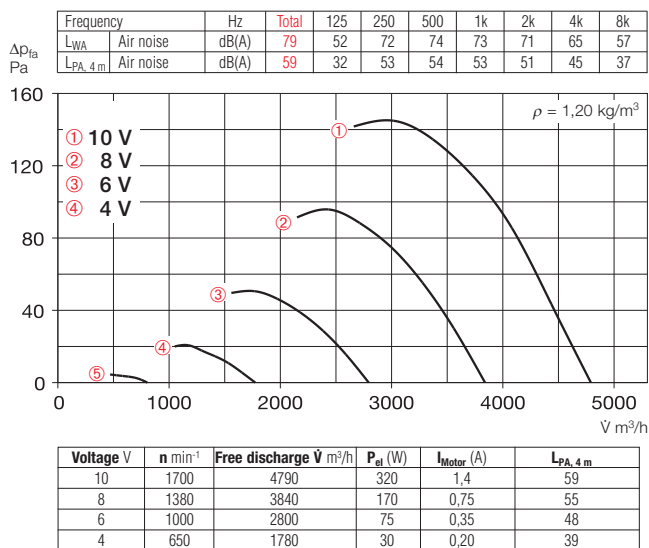

400 B

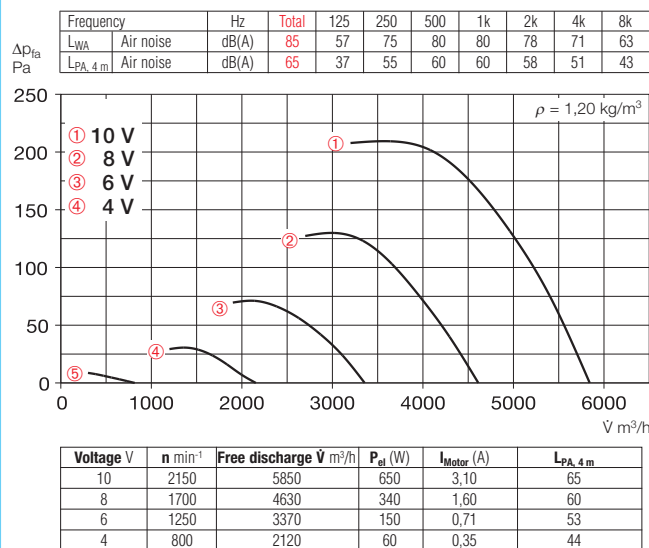

Accessories for HRF EC Description see page 231 on

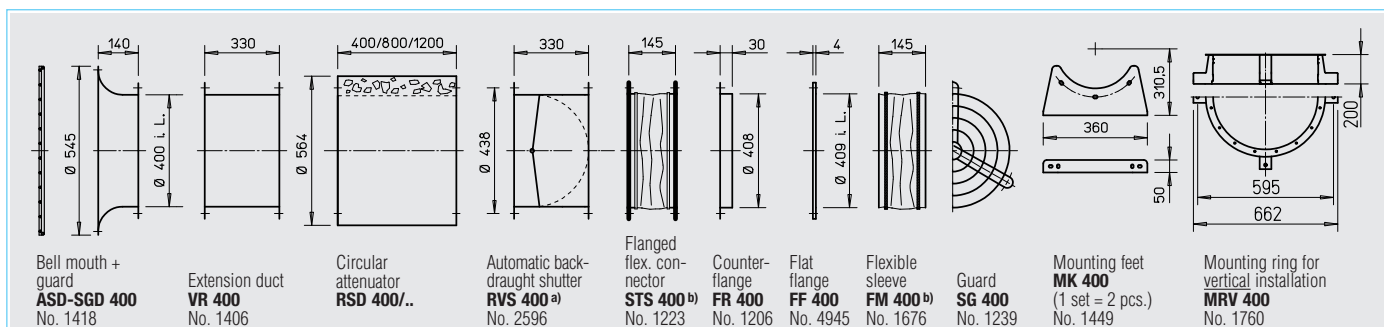

^{a)} Motorised backdraught shutter see Accessories product pages

Information	Page	Other accessories	Page
Techn. description	140	Filters and attenuators	421 on
Selection chart	141	Backdraught shutters and grilles	487 on
Information for planning	10 on	Universal control system, electronic controller, speed-potentiometer	539 on

Made to order designs
Alternative voltages, protection classes, air flow direction, air flow temperature, acid protection and cast aluminium impellers are available on request.

Note the technical information on page 15 on.

Universal control system		Speed-potentiometer flush		Three-step speed switch flush		Electronic diff. pressure controller/switch		Electronic temperature controller/switch					
Type	Ref. no.	Type	Ref. no.	Type	Ref. no.	Type	Ref. no.	Type	Ref. no.				
EUR EC ¹⁾	1347	PU 10 ¹⁾	1734	PA 10 ¹⁾	1735	SU-3 10 ¹⁾	4266	SA-3 10 ¹⁾	4267	EDR ¹⁾	1437	ETR ¹⁾	1438
EUR EC ¹⁾	1347	PU 10 ¹⁾	1734	PA 10 ¹⁾	1735	SU-3 10 ¹⁾	4266	SA-3 10 ¹⁾	4267	EDR ¹⁾	1437	ETR ¹⁾	1438

¹⁾ Several EC fans can normally be connected, see Accessories

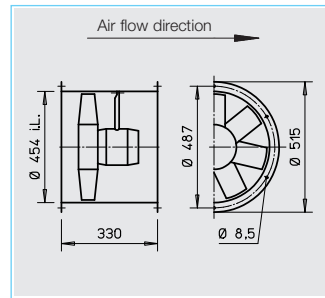
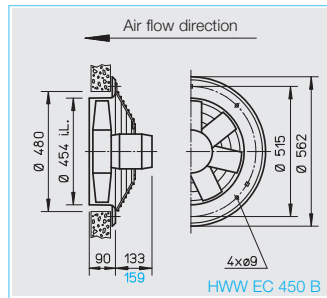
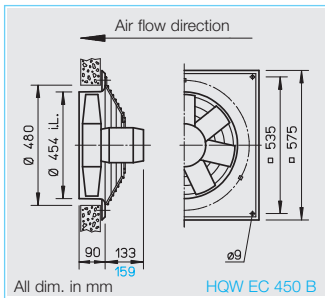

55% Saving*
* with speed control

■ **Specification for all types**

□ **Casing**

Manufactured in galvanised sheet steel. Models HQ and HW have the additional protection of two coats of papyrus white.

□ **Impeller**

Highly efficient with profiled polymer blades, aerodynamically optimised for application, dynamically balanced. Operating range from -30 to +60 °C.

□ **Motor**

Energy-saving, speed-controllable EC external rotor motor protected to IP 54 with high level of efficiency. Maintenance-free and interference-free, excellent electromagnetic compatibility (EMC), ball bearing mounted.

□ **Motor protection**

Integrated electronic temperature monitoring for EC motor and electronics.

□ **Electrical connection**

Standard terminal box (protection to IP 54) For HQ and HW types mounted to running cable ("A") or on the back of the motor ("B"). For HRF types on the outside of the ducting.

□ **Guard**

Made from powder-coated steel for HQ and HW, in accordance with DIN EN ISO 13857.

□ **Speed control**

All types are steplessly controllable through the speed-potentiometer. Furthermore, control is also possible via three-step switch or steplessly via universal control system or electronic differential pressure/temperature controller. See table below. The example performance stages are shown in the characteristic curves.

□ **Installation**

Installation in any position.

□ **Sound levels**

Sum levels and spectrum figures for sound power and sound pressure levels in 4 m free field conditions are specified above the characteristic curve for a medium intake/exhaust operating point. The sound pressure sum level in 4 m (free field conditions) is also shown in the table below and the table below the characteristic curve for different voltages. Sound emissions and room acoustics see page 10.

R.P.M.	Air flow volume (FID)	Motor power	Current	Sound pressure	Wiring diagram	max. air flow temperature	Weight net approx.	Type					
								HQ EC incl. guard	Ref. no.	HW EC incl. guard	Ref. no.	HRF EC	Ref. no.
min ⁻¹	V m ³ /h	kW	A	dB(A) in 4 m	No.	+°C	kg						
1 ph. motor, 1~ 230 Volt, 50/60 Hz, EC motor, protection to IP 54													
1320	5460	0.29	1.30	55	1047	40	14.5	HQW EC 450 A	4928	HWW EC 450 A	4929	HRFW EC 450 A	4930
1835	7640	0.82	3.80	64	1048	40	16.5	HQW EC 450 B	4931	HWW EC 450 B	4932	HRFW EC 450 B	4933

450 A

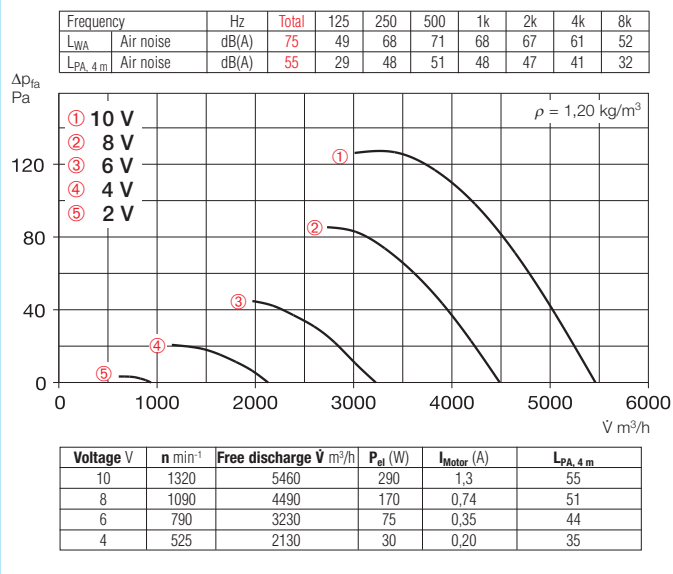

450 B

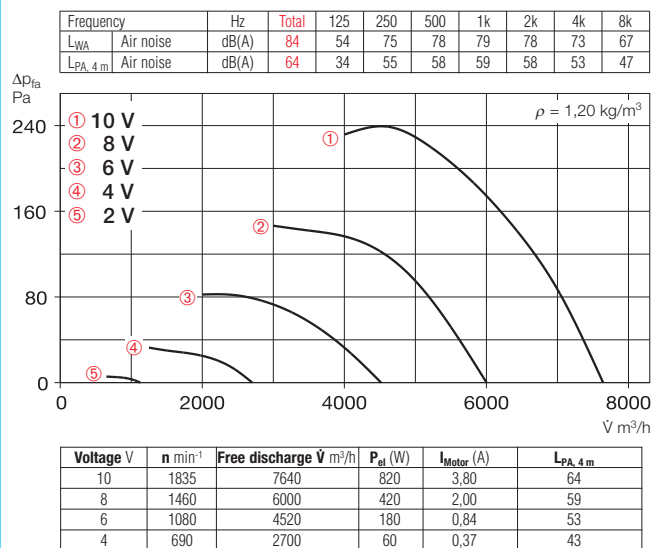

Accessories for HRF EC Description see page 231 on

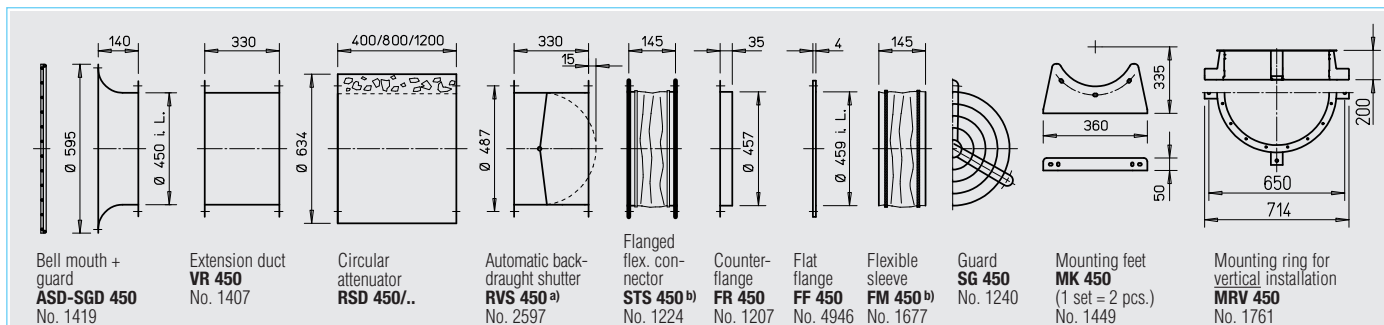

^{a)} Motorised backdraught shutter see Accessories product pages

Information	Page
Techn. description	140
Selection chart	141
Information for planning	10 on

Made to order designs

Alternative voltages, protection classes, air flow direction, air flow temperature, acid protection and cast aluminium impellers are available on request.

Note the technical information on page 15 on.

Other accessories	Page
Filters and attenuators	421 on
Backdraught shutters and grilles	487 on
Universal control system, electronic controller, speed-potentiometer	539 on

Universal control system		Speed-potentiometer flush		Three-step speed switch flush		Electronic diff. pressure controller/switch		Electronic temperature controller/switch					
Type	Ref. no.	Type	Ref. no.	Type	Ref. no.	Type	Ref. no.	Type	Ref. no.				
EUR EC ¹⁾	1347	PU 10 ¹⁾	1734	PA 10 ¹⁾	1735	SU-3 10 ¹⁾	4266	SA-3 10 ¹⁾	4267	EDR ¹⁾	1437	ETR ¹⁾	1438
EUR EC ¹⁾	1347	PU 10 ¹⁾	1734	PA 10 ¹⁾	1735	SU-3 10 ¹⁾	4266	SA-3 10 ¹⁾	4267	EDR ¹⁾	1437	ETR ¹⁾	1438

¹⁾ Several EC fans can normally be connected, see Accessories

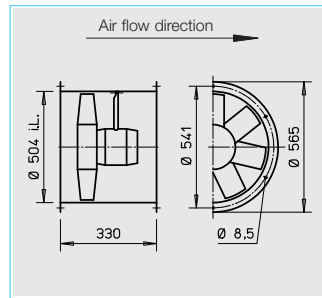
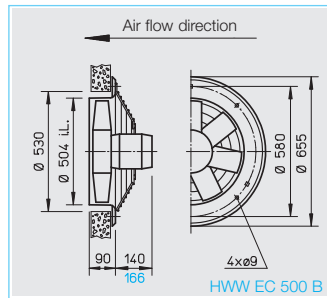
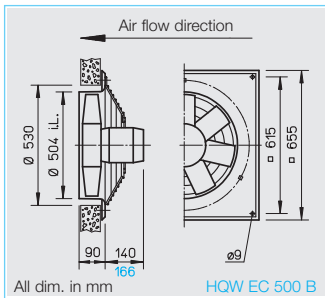

■ **Specification for all types**

□ **Casing**

Manufactured in galvanised sheet steel. Models HQ and HW have the additional protection of two coats of papyrus white.

□ **Impeller**

Highly efficient with profiled polymer blades, aerodynamically optimised for application, dynamically balanced. Operating range from -30 to +60 °C.

□ **Motor**

Energy-saving, speed-control-able EC external rotor motor protected to IP 54 with high level of efficiency. Maintenance-free and interference-free, excellent electromagnetic compatibility (EMC), ball bearing mounted.

□ **Motor protection**

Integrated electronic temperature monitoring for EC motor and electronics.

□ **Electrical connection**

Standard terminal box (protection to IP 54) For HQ and HW types mounted to running cable ("A") or on the back of the motor ("B"). For HRF types on the outside of the ducting.

□ **Guard**

Made from powder-coated steel for HQ and HW, in accordance with DIN EN ISO 13857.

□ **Speed control**

All types are steplessly control-able through the speed-potentiometer. Furthermore, control is also possible via three-step switch or steplessly via universal control system or electronic differential pressure/temperature controller. See table below. the example performance stages are shown in the characteristic curves.

□ **Installation**

Installation in any position.

□ **Sound levels**

Sum levels and spectrum figures for sound power and sound pressure levels in 4 m free field conditions are specified above the characteristic curve for a medium intake/exhaust operating point. The sound pressure sum level in 4 m (free field conditions) is also shown in the table below and the table below the characteristic curve for different voltages. Sound emissions and room acoustics see page 10.

R.P.M.	Air flow volume (FID)	Motor power	Current	Sound pressure	Wiring diagram	max. air flow temperature	Weight net approx.	Type					
								HQ EC incl. guard	Ref. no.	HW EC incl. guard	Ref. no.	HRF EC	Ref. no.
min ⁻¹	V m ³ /h	kW	A	dB(A) in 4 m	No.	+°C	kg						
1 ph. motor, 1~ 230 Volt, 50/60 Hz, EC motor, protection to IP 54													
1090	6320	0.29	1.30	54	1047	40	15.7	HQW EC 500 A	4934	HWW EC 500 A	4935	HRFW EC 500 A	4936
1450	8300	0.67	3.00	62	1048	40	17.7	HQW EC 500 B	4937	HWW EC 500 B	4938	HRFW EC 500 B	4939

500 A

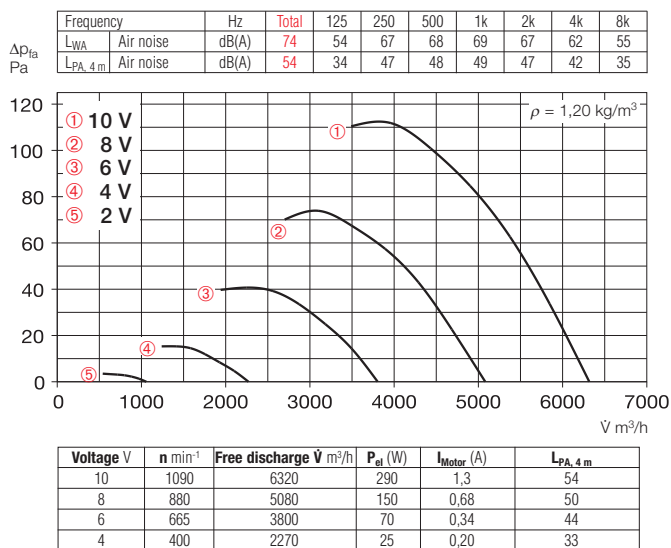

500 B

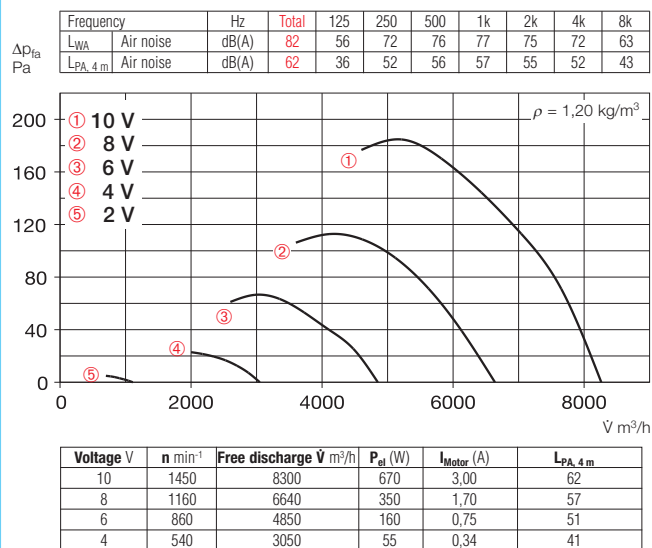

Accessories for HRF EC Description see page 231 on

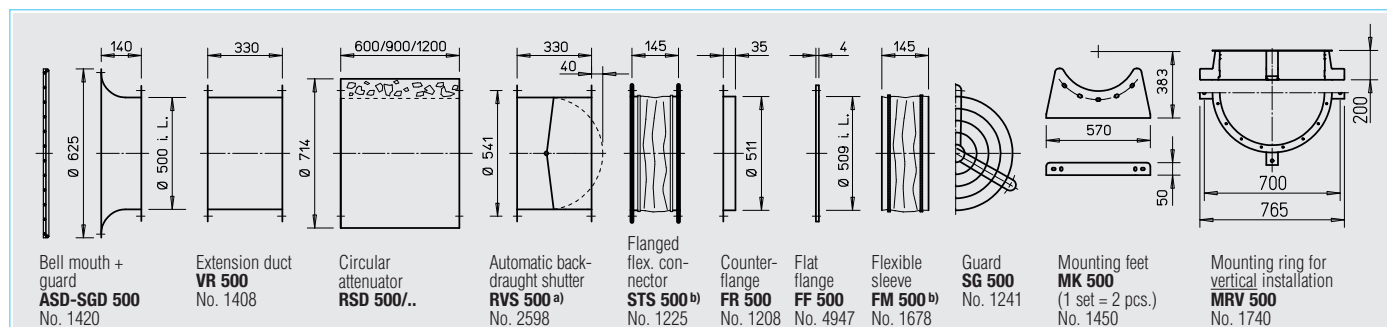

^{a)} Motorised backdraught shutter see Accessories product pages

Information	Page
Techn. description	140
Selection chart	141
Information for planning	10 on

Made to order designs
 Alternative voltages, protection classes, air flow direction, air flow temperature, acid protection and cast aluminium impellers are available on request.

Note the technical information on page 15 on.

Other accessories	Page
Filters and attenuators	421 on
Backdraught shutters and grilles	487 on
Universal control system, electronic controller, speed-potentiometer	539 on

Universal control system		Speed-potentiometer flush		Three-step speed switch flush		Electronic diff. pressure controller/switch		Electronic temperature controller/switch					
Type	Ref. no.	Type	Ref. no.	Type	Ref. no.	Type	Ref. no.	Type	Ref. no.				
EUR EC ¹⁾	1347	PU 10 ¹⁾	1734	PA 10 ¹⁾	1735	SU-3 10 ¹⁾	4266	SA-3 10 ¹⁾	4267	EDR ¹⁾	1437	ETR ¹⁾	1438
EUR EC ¹⁾	1347	PU 10 ¹⁾	1734	PA 10 ¹⁾	1735	SU-3 10 ¹⁾	4266	SA-3 10 ¹⁾	4267	EDR ¹⁾	1437	ETR ¹⁾	1438

¹⁾ Several EC fans can normally be connected, see Accessories

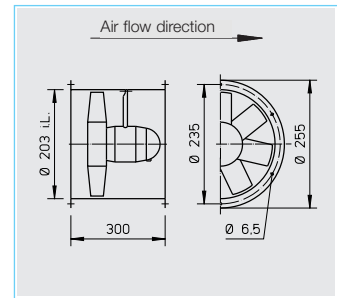
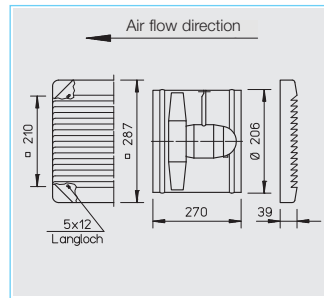
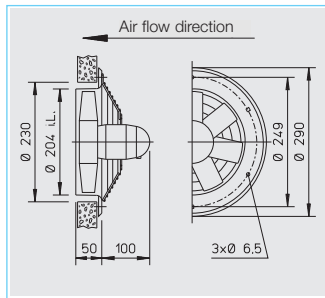
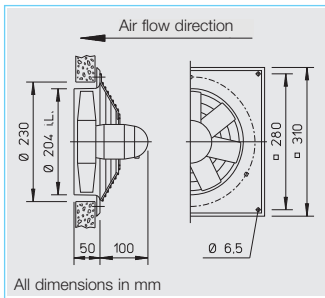

All dimensions in mm

■ **Specification for all models**

□ **Casing**

Manufactured in galvanised sheet steel. Model HQ and HW have an additional two-layer finishing in papyrus white.

□ **Impeller**

Highly efficient, profiled blade impeller, dynamically balanced and manufactured from impact resistant polymers. Suitable for -30 to +60 °C.

□ **Motor**

Totally enclosed motor with a die-cast aluminium casing, protected to IP 54. Ball bearing mounted. Maintenance-free and interference-free. Humidity protection of windings. For maximum air flow temperature see table below.

□ **Motor protection**

All models have automatically resetting thermal contacts wired in series with the motor windings.

□ **Electrical connection**

Terminal box (IP 54) mounted on rear of motor as standard. Also on outside of piping for HRF.

□ **Guard**

Powder-coated steel wire for HQ (Ex-models galvanised) according to DIN EN ISO 13857.

□ **Speed control**

All models are speed controllable by voltage reduction (transformer controller or electronic controller) For according air flow volume see performance curve.

□ **Reversed operation**

All models are reversible when wired to a DSEL reversing switch. For reverse air flow direction allow for 1/3 drop in performance.

□ **Installation**

Installation in any position. Ensure that the motor drainage holes face downwards.

□ **Sound levels**

See characteristic curve. The sound power and sound pressure are specified at 1 m distances under free field conditions, for average operating point suction/pressure side. See page 10 on for sound emission and acoustics.

■ **Information** Page

Techn. description	140
Selection chart	141
Information for planning	10 on

■ **Made to order designs**

Alternative voltages, protection classes, air flow direction, air flow temperature, acid protection and cast aluminium impellers are available on request.

Note the technical information on page 15 on.

R.P.M.	Air flow volume (FID)	Motor power	Current*		Wiring diagram	max. air flow temp.		Weight net	Model							
			standard-supply	max. controlled		standard supply	speed controlled		HQ incl. guard	Ref. no.	HW incl. guard	Ref. no.	HS incl. guard	Ref. no.	HRF	Ref. no.
min ⁻¹	V m ³ /h	W	A	A	No.	+°C	+°C	kg								
1 Phase motor, 230 Volt / 50 Hz, capacitor motor, protection to IP 54																
1360	520	25	0.11	0.11	439 ¹⁾	60	40	3.8	HQW 200/4	7537	HWW 200/4	7538	HSW 200/4	7502	HRFW 200/4¹⁾	7540
2250	930	66	0.26	0.31	439 ¹⁾	40	40	2.7	HQW 200/2	0960	—	—	HSW 200/2	7503	HRFW 200/2¹⁾	0199

¹⁾ Type HRFW: connect pursuant to wiring diagram no. SS-962.

200/2

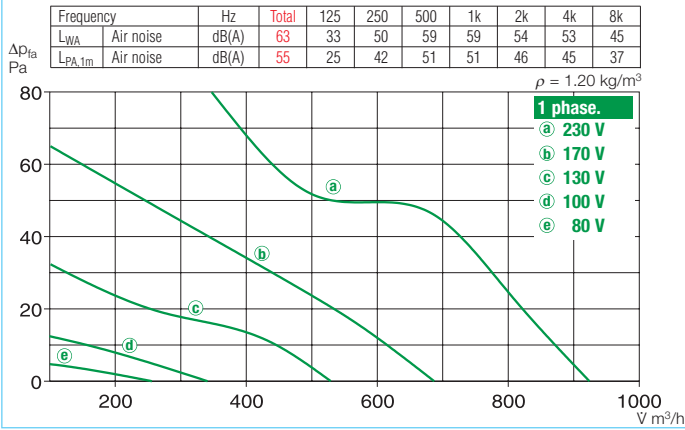

200/4

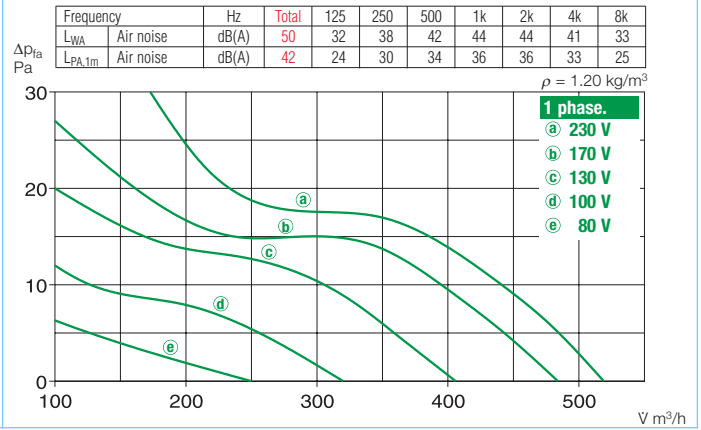

Accessories for HRF Description see page 230 on

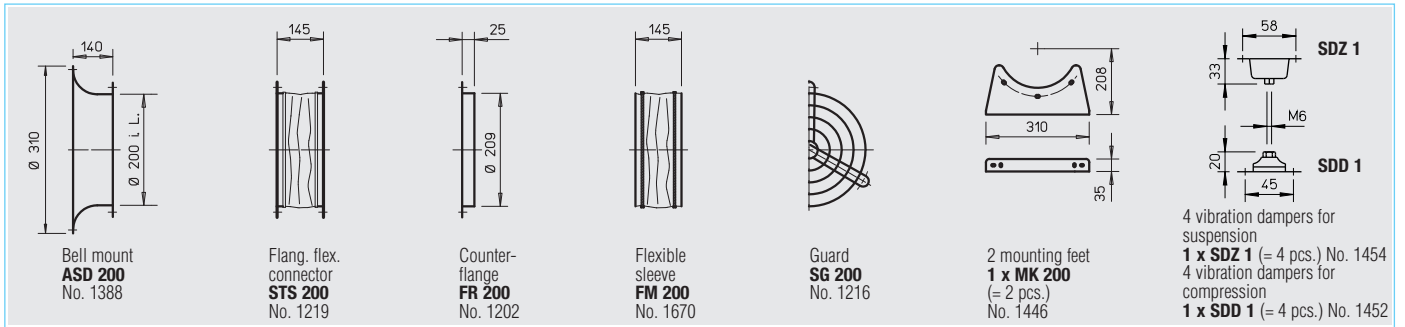

Other accessories Page

Extension tube for HS
Type VH 200 Ref. no. 1349
 Cylindrical duct, galvanised steel,
 length: 150 mm.

Attenuators 421 on
 Shutters and grilles 487 on
 Speed controllers and switches 525 on

Transformer controller for 5 speed		Electronic controller, stepless flush/surf.		Reversing switch		Electronic controller with reversing switch	
Model	Ref. no.	Model	Ref. no.	Model	Ref. no.	Model	Ref. no.
TSW 0,3	3608	ESU 1/ESA 1	0236/0238	DSEL 2	1306	BSX	0240
TSW 0,3	3608	ESU 1/ESA 1	0236/0238	DSEL 2	1306	BSX	0240

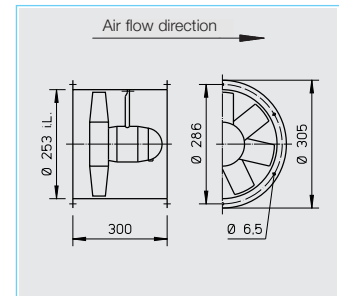
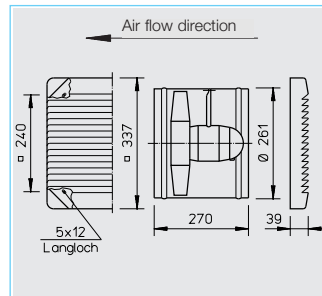
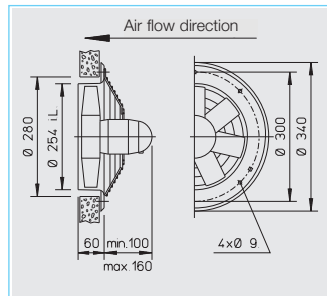
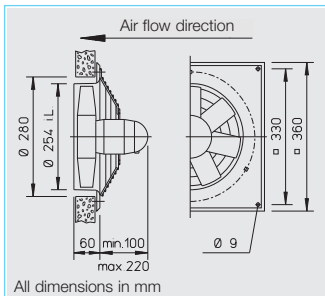

■ Specification for all models

□ Casing

Manufactured in galvanised sheet steel. Model HQ and HW have an additional two-layer finishing in papyrus white. Ex-models without paint.

□ Impeller

Highly efficient, profiled blade impeller, dynamically balanced and manufactured from impact resistant polymers. Suitable for -30 to +60 °C. Deviation for ex-models.

□ Motor

Totally enclosed motor with a die-cast aluminium casing, protected to IP 55 or IP 54. Ball bearing mounted. Maintenance-free and interference-free. Humidity protection of windings. For maximum air flow temperature see table below. Deviation for ex-models.

□ Motor protection

All models (3~ explosion proof excluded) have thermal contacts as standard which must be connected to a motor protection unit (see below). The models H..W 250/6, H..W 250/4 and all 1 ph. ex-proof fans have automatic resetting thermal contacts wired in series with the motor windings.

□ Electrical connection

Terminal box (IP 54/55) mounted on rear of motor as standard. Also on outside of piping for HRF. Deviation for ex-models.

□ Guard

Powder-coated steel wire for HQ and HW (HQ ex-models galvanised) according to DIN EN ISO 13857.

□ Speed control

For all speed controllable models the current are identified with a value in the "speed controlled" column of the table below which must be used when selecting a controller. Possible allocations of frequency inverters are specified in the table below. The planned use of a frequency inverter without Sine filter must be stated when ordering. This requires a change of fan design and potential additional costs. The air flow rates are shown in the performance curves.

□ Reversed operation

All models are reversible when wired to a reversing switch. For reverse air flow direction allow a loss in performance of approx. 1/3.

□ Installation

Installation in any position. Ensure that the motor drainage holes face downwards.

□ Dimensions

Pole-switch and explosion proof models may deviate from the information above.

□ Sound levels

See characteristic curve. The sound power and sound pressure are specified at 4 m distances under free field conditions, for average operating point suction/pressure side. See page 10 on for sound emission and acoustics. Deviation for ex-models.

Information	Page
Techn. description	140
Selection chart	141
Information for planning	10 on

R.P.M.	Air flow volume (FID)	Motor power	Current*		Wiring diagram	max. air flow temp.		Weight net	Model							
			standard-supply	max. controlled		standard supply	speed controlled		HQ incl. guard	Ref. no.	HW incl. guard	Ref. no.	HS incl. guard	Ref. no.	HRF	Ref. no.
min ⁻¹	V m ³ /h	W	A	A	No.	+°C	+°C	kg								
1 Phase motor, 230 Volt / 50 Hz, capacitor motor, protection to IP 54/IP 55																
930	660	35	0.20	0.22	317	60	40	6.5	HQW 250/6	1102	—	—	HSW 250/6	0139	—	—
1300	930	36	0.15	0.15	439 ²⁾	60	40	7.5	HQW 250/4 ¹⁾	1103	HWW 250/4 ¹⁾	1001	HSW 250/4 ¹⁾	0140	HRFW 250/4 ¹⁾²⁾	0200
2710	2070	187	0.81	0.9	317 ³⁾	60	40	6.5	HQW 250/2	1104	HWW 250/2	1002	HSW 250/2	0141	HRFW 250/2 ³⁾	0201
3 Phase motor, 400 Volt / 50 Hz, squirrel cage motor protection to IP 55																
980	700	61	0.27	0.33	469	60	40	6.5	HQD 250/6	1114	—	—	—	—	—	—
1390	950	55	0.15	0.15	469	60	40	6.5	HQD 250/4 ¹⁾	1115	HWD 250/4 ¹⁾	1016	HSD 250/4 ¹⁾	0155	HRFD 250/4 ¹⁾	0220
2550	2000	169	0.31	0.33	469	60	40	6.5	HQD 250/2	1116	HWD 250/2	1017	—	—	HRFD 250/2	0221
2 speed motor, pole-switching, Dahlander windings, 400 Volt, 50 Hz, protection to IP 55																
1430/2770	1030/2110	58/212	0.16/0.43		472	60	—	8.5	HQD 250/4/2	1128	—	—	—	—	HRFD 250/4/2	0390
Explosion proof Ex d II B, 1 ph., 230 Volt, 50 Hz, protection to IP 55, temp. class T1-T3																
1400	1030	60*	0.70*		757	40	—	12	HQW 250/4 Ex	0438	—	—	—	—	HRFW 250/4 Ex	0437
2690	1950	180*	1.23*		757	40	—	13	HQW 250/2 Ex	1094	—	—	—	—	HRFW 250/2 Ex	1095
Explosion proof Ex e II, 3 ph., 400 Volt, 50 Hz, protection to IP 55, temp. class T1-T3																
1350	1070	120*	0.37*		470	40	—	12	HQD 250/4 Ex	1144	—	—	—	—	HRFD 250/4 Ex	0470
2800	2070	250*	0.75*		470	40	—	11	HQD 250/2 Ex	1145	—	—	—	—	HRFD 250/2 Ex	0471

* Motor nominal values, Ex see info page 16.

¹⁾ Special design not possible. ²⁾ Type HRFW: connect using wiring diagram no. SS-962. ³⁾ Type HRFW../2: connect using wiring diagram no. SS-963.

250/2

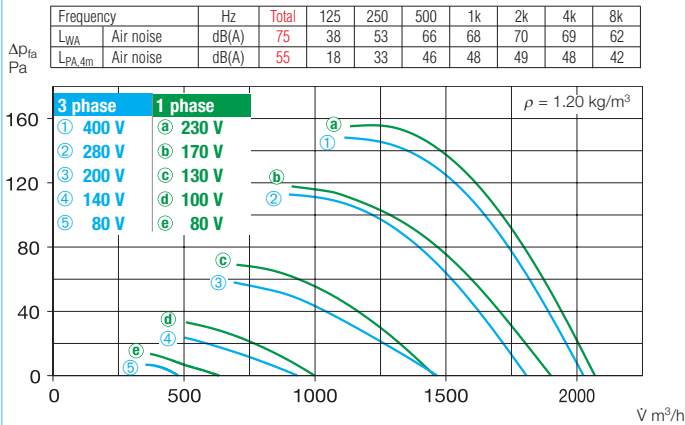

250/4 Three phase

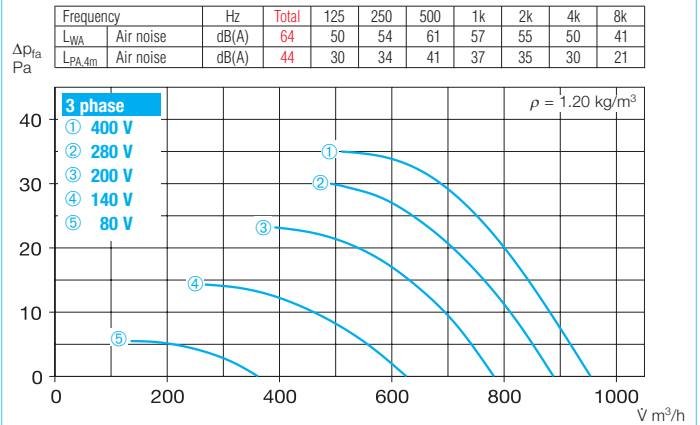

250/4 Single phase

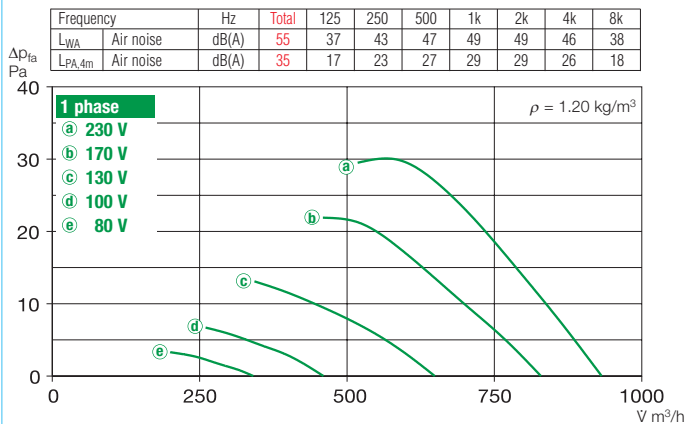

250/6

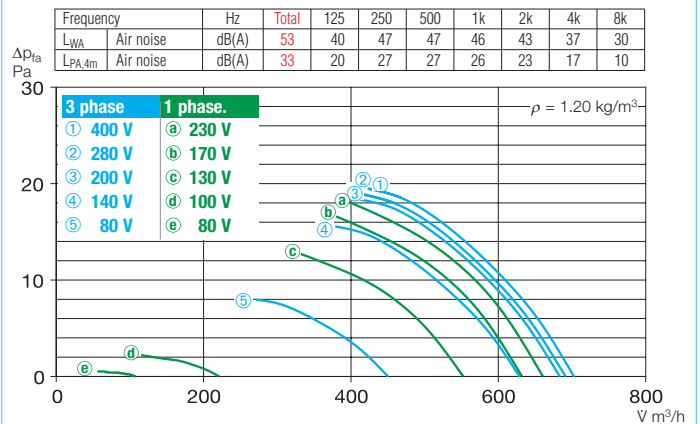

Accessories for HRF Description see page 230 on

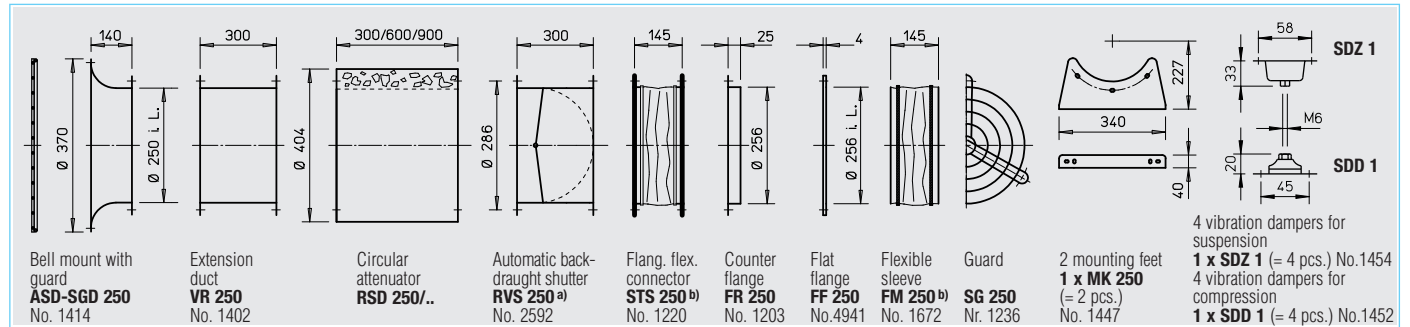

a) For motorised shutters see accessory page

b) Models for ex-proof fans see below

Frequency inverter with integrated Sine filter		Transformer controller 5-speed Pole switch		Electronic controller, stepless flush/surf.		Full motor protection for connection of integrated thermal contacts		Reversing switch	
Model	Ref. no.	Model	Ref. no.	Model	Ref. no.	Model	Ref. no.	Model	Ref. no.
—	—	TSW 0,3	3608	ESU 1/ESA 1	0236/0238	—	—	WS	1271
—	—	TSW 0,3	3608	ESU 1/ESA 1	0236/0238	—	—	DSEL 2	1306
—	—	MWS 1,5	1947	ESU 3/ESA 3	0237/0239	MW	1579	WS	1271
FU-BS 2,5⁴⁾	5459	RDS 1⁴⁾	1314	—	—	MD	5849	WS	1271
FU-BS 2,5⁴⁾	5459	RDS 1⁴⁾	1314	—	—	MD	5849	WS	1271
FU-BS 2,5⁴⁾	5459	RDS 1⁴⁾	1314	—	—	MD	5849	WS	1271
—	—	Pole switch		—	—	—	—	—	—
—	—	PDA 12⁶⁾	5081	—	—	M 3⁵⁾	1293	PWDA	1282
—	—	not permitted	not permitted	not permitted	not permitted	—	—	—	—
—	—	not permitted	not permitted	not permitted	not permitted	—	—	—	—
—	—	not permitted	not permitted	not permitted	not permitted	—	—	—	—
—	—	not permitted	not permitted	not permitted	not permitted	—	—	—	—

⁴⁾ Incl. full motor protection.

⁵⁾ Incl. pole switch.

⁶⁾ See switch product page for flush mounted version

Other accessories Page

^{b)} Accessories for explosion proof fans

Flanged flexible connector
Type STS 250 Ex Ref. no. 2501

Flexible sleeve
Type FM 250 Ex Ref. no. 1688

Extension tube for HS
Type VH 250 Ref. no. 1343

Cylindrical duct, galvanised steel, length: 150 mm.

Attenuators 421 on
Shutters and grilles 487 on
Speed controllers and switches 525 on

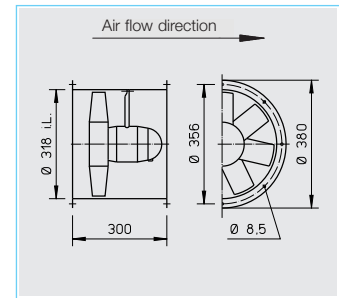
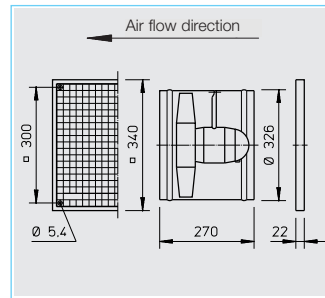
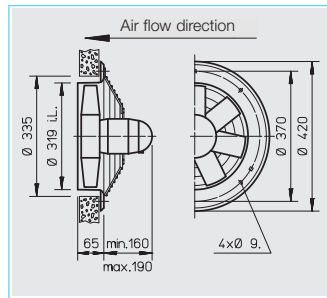
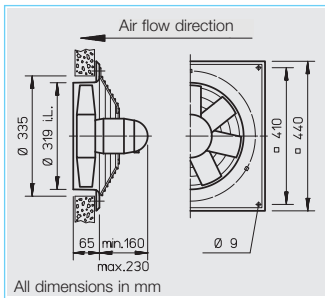
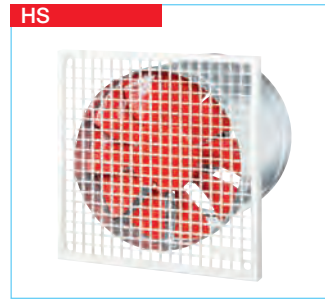

■ Specification for all models

□ Casing

Manufactured in galvanised sheet steel. Model HQ and HW have an additional two-layer finishing in papyrus white. Ex-models without paint.

□ Impeller

Highly efficient, profiled blade impeller, dynamically balanced and manufactured from impact resistant polymers. Suitable for -30 to +60 °C. Deviation for ex-models.

□ Motor

Totally enclosed motor with a die-cast aluminium casing, protected to IP 55. Ball bearing mounted. Maintenance-free and interference-free. Humidity protection of windings. For maximum air flow temp. see table below. Deviation for ex-models.

□ Motor protection

All models (3~ explosion proof excluded) have thermal contacts as standard which must be connected to a motor protection unit (see below). The models H.W 315/6 and all 1 ph. ex-proof fans have automatic resetting thermal contacts wired in series with the motor windings.

□ Electrical connection

Terminal box (IP 55) mounted on rear of motor as standard. Also on outside of piping for HRF. Deviation for ex-models.

□ Guard

Powder-coated steel wire for HQ and HW (HQ ex-models galvanised), polymer for HS according to DIN EN ISO 13857.

□ Speed control

For all speed controllable models the current are identified with a value in the "speed controlled" column of the table below which must be used when selecting a controller. Possible allocations of frequency inverters are specified in the table below. The planned use of a frequency inverter without Sine filter must be stated when ordering. This requires a change of fan design and potential additional costs. The air flow rates are shown in the performance curves.

□ Reversed operation

All models are reversible when wired to a reversing switch. For reverse air flow direction allow a loss in performance of approx. 1/3.

□ Installation

Installation in any position. Ensure that the motor drainage holes face downwards.

□ Dimensions

Pole-switch and explosion proof models may deviate from the information above.

□ Sound levels

See characteristic curve. The sound power and sound pressure are specified at 4 m distances under free field conditions, for average operating point suction/pressure side. See page 10 on for sound emission and acoustics. Deviation for ex-models.

R.P.M.	Air flow volume (FID)	Motor power	Current*		Wiring diagram	max. air flow temp.		Weight net	Model							
			standard-supply	max. controlled		standard supply	speed controlled		HQ incl. guard	Ref. no.	HW incl. guard	Ref. no.	HS incl. guard	Ref. no.	HRF	Ref. no.
min ⁻¹	V m ³ /h	W	A	A	No.	+°C	+°C	kg								
1 Phase motor, 230 Volt / 50 Hz, capacitor motor, protection to IP 55																
920	1330	33	0.25	0.35	317 ¹⁾	60	40	9.0	HQW 315/6	1105	—	—	HSW 315/6	0142	HRFW 315/6 ¹⁾	0202
1390	2080	104	0.45	0.47	475 ²⁾	60	40	8.0	HQW 315/4	1106	HWW 315/4	1004	HSW 315/4	0143	HRFW 315/4 ²⁾	0203
3 Phase motor, 400 Volt / 50 Hz, squirrel cage motor protection to IP 55																
950	1370	68	0.27	0.32	469	60	40	9.0	HQD 315/6	1117	—	—	—	—	—	—
1330	1960	84	0.24	0.26	469	60	40	9.0	HQD 315/4	1118	HWD 315/4	1019	HSD 315/4	0158	HRFD 315/4	0223
2760	4080	527	1.10	1.23	469	50	40	11.0	HQD 315/2	1119	HWD 315/2	1020	—	—	HRFD 315/2	0224
Two-speed, 3 ph., 400 V, 50 Hz, Y/Δ switch, protection to IP 55																
1040/1280	1530/1980	56/87	0.11/0.22		520	60	—	10.5	HQD 315/4/4	1460	—	—	—	—	HRFD 315/4/4	1462
2 speed motor, pole-switching, Dahlander windings, 400 Volt, 50 Hz, protection to IP 55																
720/1445	980/2060	49/115	0.20/0.43		472	60	—	12.0	HQD 315/8/4	1129	—	—	HSD 315/8/4	0346	HRFD 315/8/4	0391
1445/2845	2100/4190	106/558	0.45/1.32		472	50	—	12.5	HQD 315/4/2	1131	—	—	HSD 315/4/2	0348	HRFD 315/4/2	0393
Explosion proof Ex d II B, 1 ph., 230 Volt, 50 Hz, protection to IP 55, temp. class T1-T3																
1370	2070	180*	1.25*		757	40	—	13.0	HQW 315/4 Ex	0442	—	—	—	—	HRFW 315/4 Ex	0439
Explosion proof Ex e II, 3 ph., 400 Volt, 50 Hz, protection to IP 55, temp. class T1-T3																
920	1400	250*	0.97*		470	40	—	23.0	HQD 315/6 Ex	1098	—	—	—	—	—	—
1350	2140	120*	0.37*		470	40	—	14.0	HQD 315/4 Ex	1147	—	—	—	—	HRFD 315/4 Ex	0473
2770	4130	550*	1.43*		470	40	—	16.5	HQD 315/2 Ex	1148	—	—	—	—	HRFD 315/2 Ex	0474

* Motor nominal values, Ex see info page 16.

¹⁾ Type HRFW./6: connect using wiring diagram no. SS-963. ²⁾ Type HRFW./4: connect using wiring diagram no. SS-965.

³⁾ Incl. full motor protection.

315/2

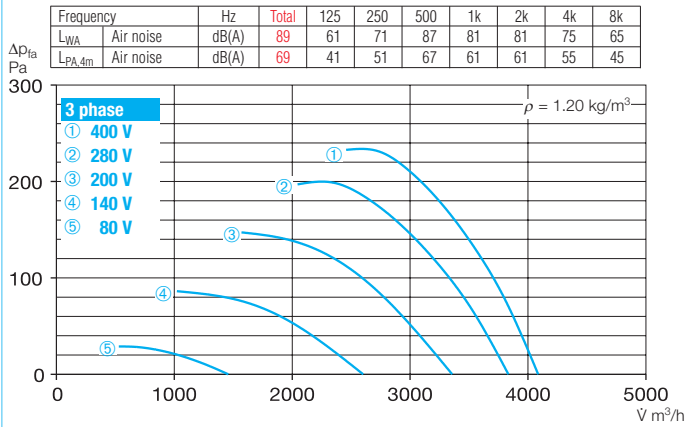

315/4

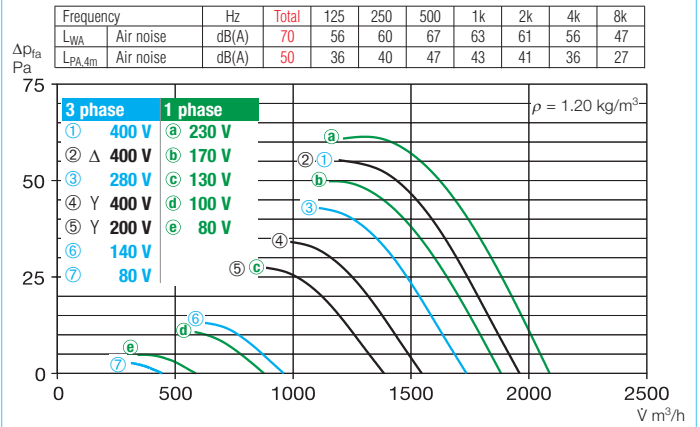

315/6

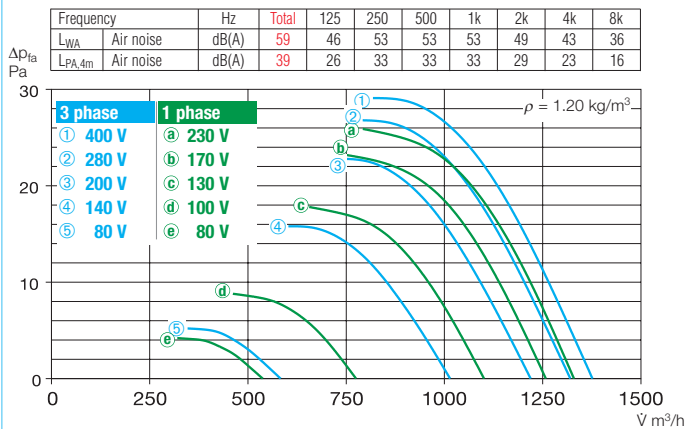

315/8

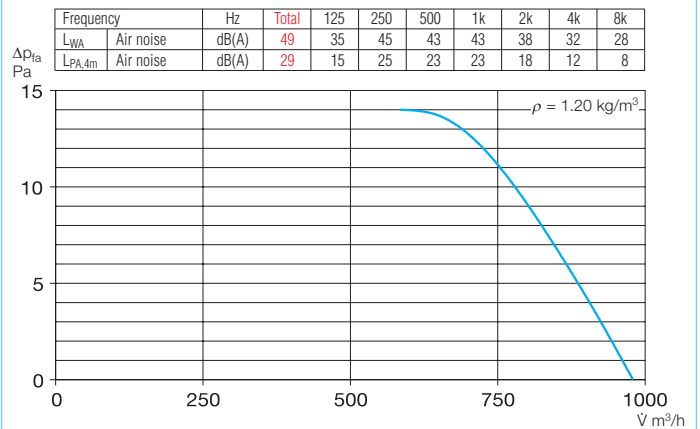

Accessories for HRF Description see page 230 on

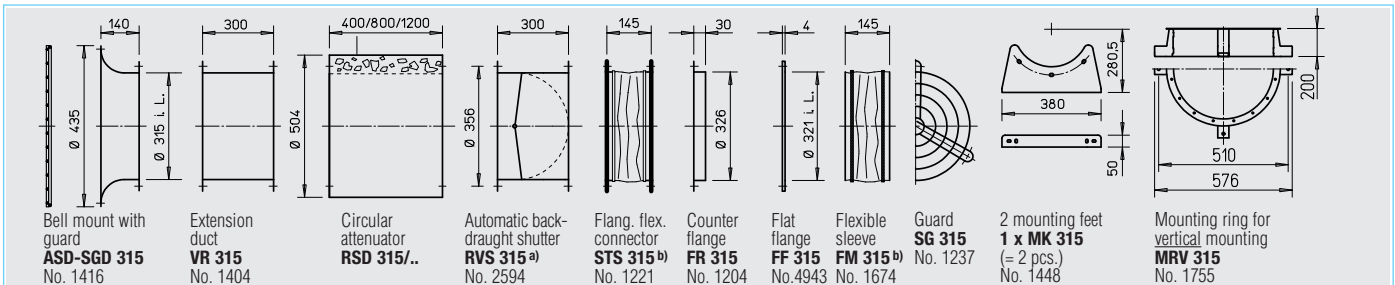

^{a)} For motorised shutters see accessory page

^{b)} Models for ex-proof fans see below

Frequency inverter with integrated Sine filter		Transformer controller 5-speed Pole switch		Electronic controller, stepless flush/surt.		Full motor protection for connection of integrated thermal contacts		Reversing switch	
Model	Ref. no.	Model	Ref. no.	Model	Ref. no.	Model	Ref. no.	Model	Ref. no.
—	—	TSW 0,3	3608	ESU 1/ESA 1	0236/0238	—	—	WS	1271
—	—	MWS 1,5³⁾	1947	ESU 1/ESA 1	0236/0238	MW	1579	WS	1271
FU-BS 2,5³⁾	5459	RDS 1³⁾	1314	—	—	MD	5849	WS	1271
FU-BS 2,5³⁾	5459	RDS 1³⁾	1314	—	—	MD	5849	WS	1271
FU-BS 2,5³⁾	5459	RDS 2³⁾	1315	ESD 5	0501	MD	5849	WS	1271
Speed switch									
FU-BS 2,5³⁾	5459	DS2	1351	—	—	M 4⁴⁾/MD	1571/5849	WS	1271
Pole switch									
—	—	PDA 12⁵⁾	5081	—	—	M 3⁴⁾	1293	PWDA	1282
—	—	PDA 12⁵⁾	5081	—	—	M 3⁴⁾	1293	PWDA	1282
—	—	not permitted	not permitted	—	—	—	—	—	—
—	—	not permitted	not permitted	—	—	—	—	—	—
—	—	not permitted	not permitted	—	—	—	—	—	—
—	—	not permitted	not permitted	—	—	—	—	—	—

⁴⁾ Incl. pole switch.

⁵⁾ See switch product page for flush mounted version.

Other accessories Page

- Accessories for explosion proof fans**
- Flanged flexible connector
Type STS 315 Ex Ref. no. 2503
- Flexible sleeve
Type FM 315 Ex Ref. no. 1690
- Extension tube for HS
Type VH 315 Ref. no. 1344
Cylindrical duct, galvanised steel, length: 150 mm.
- Attenuators 421 on
- Shutters and grilles 487 on
- Speed controllers and switches 525 on

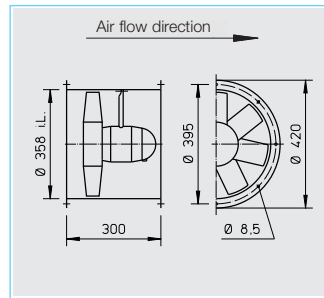
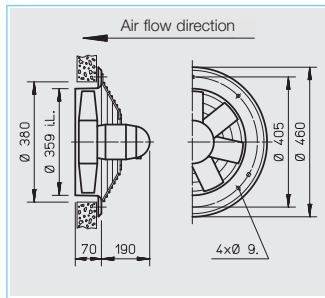
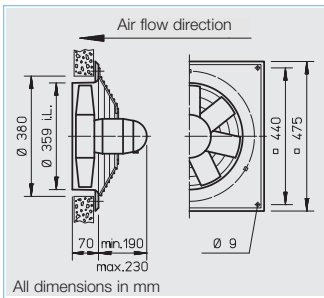

■ Specification for all models

- Casing**
Manufactured in galvanised sheet steel. Model HQ and HW have an additional two-layer finishing in papyrus white. Ex-models without paint.
- Impeller**
Highly efficient, profiled blade impeller, dynamically balanced and manufactured from impact resistant polymers. Suitable for -30 to +60 °C. Deviation for ex-models.
- Motor**
Totally enclosed motor with a die-cast aluminium casing, protected to IP 55. Ball bearing mounted. Maintenance-free and interference-free. Humidity protection of windings. For maximum air flow temp. see table below. Deviation for ex-models.

- Motor protection**
All models (3~ explosion proof excluded) have thermal contacts as standard which must be connected to a motor protection unit (see below). 1 ph. ex-proof fans have automatic resetting thermal contacts wired in series with the motor windings.
- Electrical connection**
Terminal box (IP 55) mounted on rear of motor as standard. Also on outside of piping for HRF. Deviation for ex-models.
- Guard**
Powder-coated steel wire for HQ and HW (HQ ex-models galvanised) according to DIN EN ISO 13857.

- Speed control**
For all speed controllable models the current are identified with a value in the "speed controlled" column of the table below which must be used when selecting a controller. Possible allocations of frequency inverters are specified in the table below. The planned use of a frequency inverter without Sine filter must be stated when ordering. This requires a change of fan design and potential additional costs. The air flow rates are shown in the performance curves.
- Reversed operation**
All models are reversible when wired to a reversing switch. For reverse air flow direction allow a loss in performance of approx. 1/3.

- Installation**
Installation in any position. Ensure that the motor drainage holes face downwards.
- Dimensions**
Pole-switch and explosion proof models may deviate from the information above.
- Sound levels**
See characteristic curve. The sound power and sound pressure are specified at 4 m distances under free field conditions, for average operating point suction/pressure side. See page 10 on for sound emission and acoustics. Deviation for ex-models.

R.P.M.	Air flow volume (FID)	Motor power	Current* standard-supply	Current* max. controlled	Wiring diagram	max. air flow temp. standard supply	speed controlled	Weight net	Model					
									HQ incl. guard	Ref. no.	HW incl. guard	Ref. no.	HRF	Ref. no.
min ⁻¹	V m ³ /h	W	A	A	No.	+°C	+°C	kg						
1 Phase motor, 230 Volt / 50 Hz, capacitor motor, protection to IP 55														
960	1940	75	0.47	0.47	475 ¹⁾	60	40	12	HQW 355/6	1107	—	—	HRFW 355/6 ¹⁾	0204
1345	2850	130	0.60	0.65	475 ¹⁾	60	40	11	HQW 355/4	1108	HWW 355/4	1006	HRFW 355/4 ¹⁾	0205
3 Phase motor, 400 Volt / 50 Hz, squirrel cage motor protection to IP 55														
960	1970	70	0.27	0.29	469	60	40	9.5	HQD 355/6	1120	—	—	—	—
1375	2900	130	0.35	0.35	469	60	40	11.0	HQD 355/4	1121	HWD 355/4	1022	HRFD 355/4	0226
2670	5710	825	1.60	1.60	469	60	40	15.0	HQD 355/2	1122	HWD 355/2	1023	HRFD 355/2	0227
Two-speed, 3 ph., 400 V, 50 Hz, Y/Δ switch, protection to IP 55														
1120/1350	2460/2860	90/132	0.17/0.32	—	520	60	—	11.0	HQD 355/4/4	1463	—	—	HRFD 355/4/4	1464
2 speed motor, pole-switching, Dahlander windings, 400 Volt, 50 Hz, protection to IP 55														
700/1395	1430/2920	45/145	0.14/0.35	—	472	60	—	11.0	HQD 355/8/4	1132	—	—	HRFD 355/8/4	0394
1430/2840	3050/6150	250/950*	0.63/2.30*	—	472	40	—	16.0	HQD 355/4/2	1134	—	—	HRFD 355/4/2	0396
Explosion proof Ex d II B, 1 ph., 230 Volt, 50 Hz, protection to IP 55, temp. class T1-T3														
1370	2940	180*	1.25*	—	757	40	—	18.0	HQW 355/4 Ex	0444	—	—	HRFW 355/4 Ex	0443
Explosion proof Ex e II, 3 ph., 400 Volt, 50 Hz, protection to IP 55, temp. class T1-T3														
920	2010	250*	0.97*	—	470	40	—	25.0	HQD 355/6 Ex	1101	—	—	—	—
1350	3060	120*	0.37*	—	470	40	—	18.0	HQD 355/4 Ex	1150	—	—	HRFD 355/4 Ex	0476
2830	5910	1100*	2.60*	—	470	40	—	12.5	HQD 355/2 Ex	1261	—	—	HRFD 355/2 Ex	0136

* Motor nominal values, Ex see info page 16. ¹⁾ Type HRFW: connect using wiring diagram no. SS-965. ²⁾ Incl. full motor protection. ³⁾ Incl. pole switch.

355/2

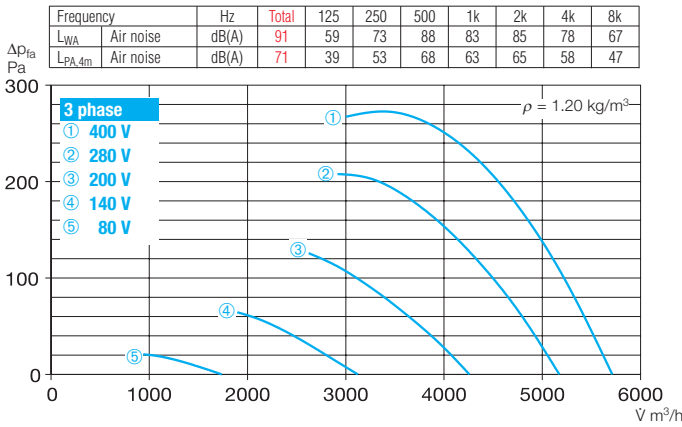

355/4

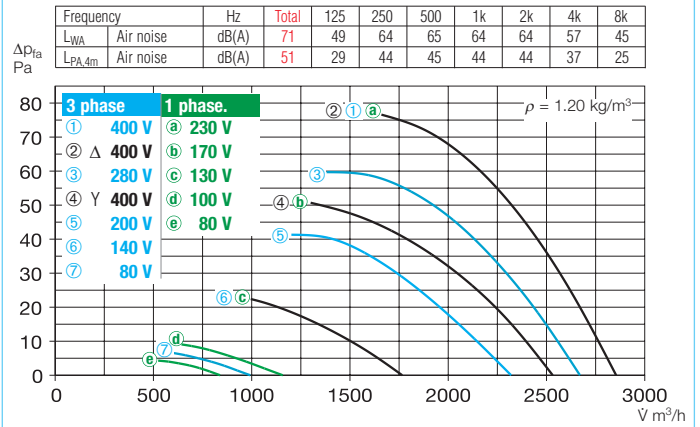

355/6

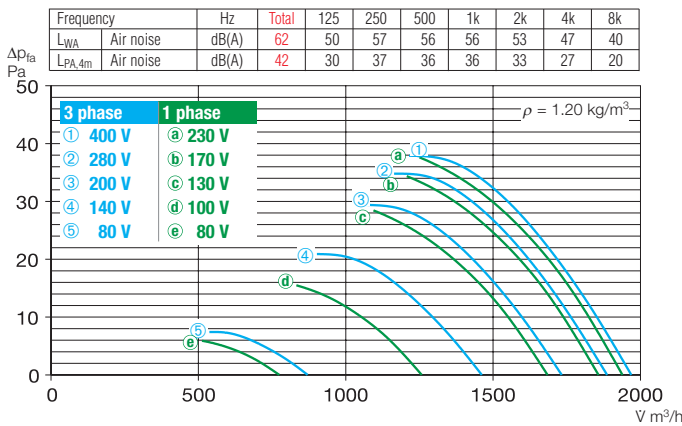

355/8

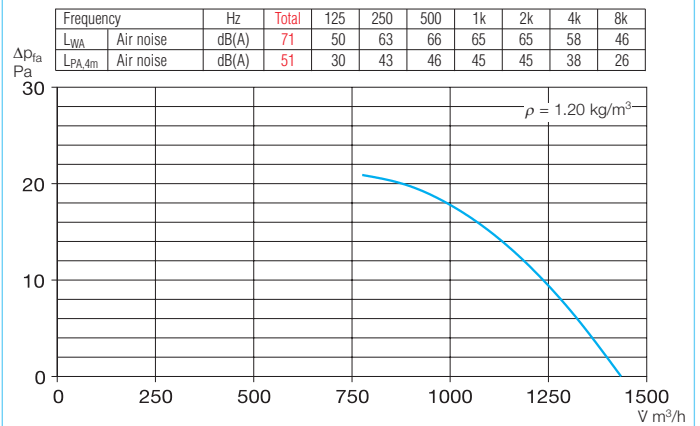

Accessories for HRF Description see page 230 on

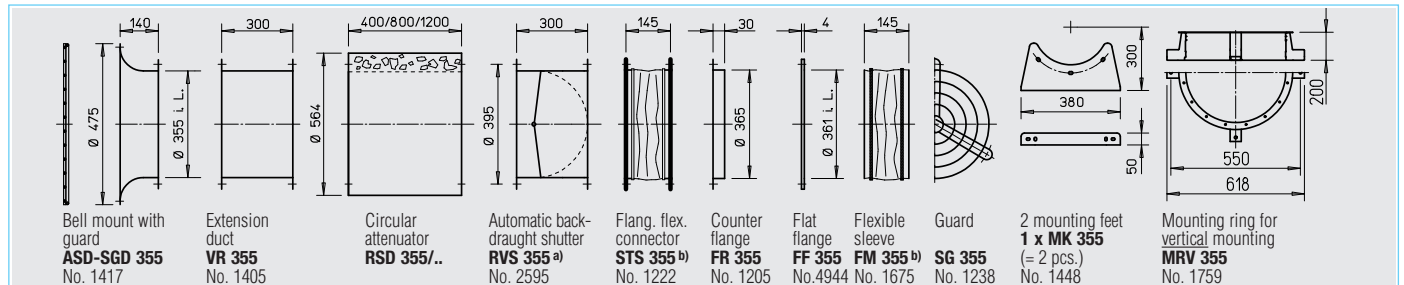

^{a)} For motorised shutters see accessory page

^{b)} Models for ex-proof fans see below

Frequency inverter with integrated Sine filter		Transformer controller 5-speed Pole switch		Electronic controller, stepless flush/surt.		Full motor protection for connection of integrated thermal contacts		Reversing switch	
Model	Ref. no.	Model	Ref. no.	Model	Ref. no.	Model	Ref. no.	Model	Ref. no.
—	—	MWS 1,5 ²⁾	1947	ESU 1/ESA 1	0236/0238	MW	1579	WS	1271
—	—	MWS 1,5 ²⁾	1947	ESU 1/ESA 1	0236/0238	MW	1579	WS	1271
FU-BS 2,5 ²⁾	5459	RDS 1 ²⁾	1314	—	—	MD	5849	WS	1271
FU-BS 2,5 ²⁾	5459	RDS 1 ²⁾	1314	—	—	MD	5849	WS	1271
FU-BS 2,5 ²⁾	5459	RDS 2 ²⁾	1315	ESD 5	0501	MD	5849	WS	1271
Speed switch		DS 2	1351	—	—	M 4 ³⁾ /MD	1571/5849	WS	1271
Pole switch		PDA 12 ⁴⁾	5081	—	—	M 3 ³⁾	1293	PWDA	1282
—	—	PDA 12 ⁴⁾	5081	—	—	MSA	1289	PWDA	1282
—	—	not permitted	not permitted	—	—	—	—	—	—
—	—	not permitted	not permitted	—	—	—	—	—	—
—	—	not permitted	not permitted	—	—	—	—	—	—
—	—	not permitted	not permitted	—	—	—	—	—	—

⁴⁾ See switch product page for flush mounted version.

Other accessories Page

^{b)} Accessories for explosion proof fans
 Flanged flexible connector Type STS 355 Ex Ref. no. 2504
 Flexible sleeve Type FM 355 Ex Ref. no. 1691

Extension tube for HS Type VH 355 Ref. no. 1345
 Cylindrical duct, galvanised steel, length: 150 mm.

Attenuators 421 on
 Shutters and grilles 487 on
 Speed controllers and switches 525 on

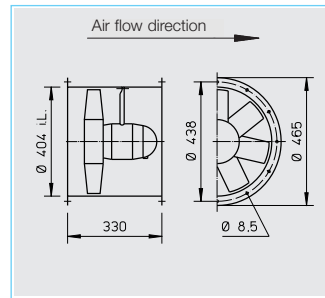
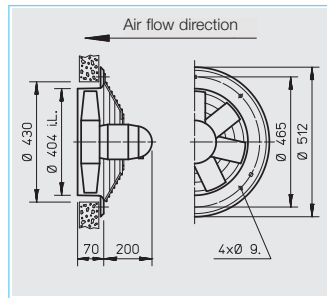
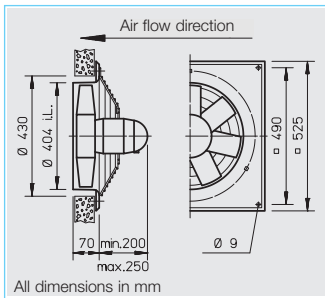

■ Specification for all models

□ Casing

Manufactured in galvanised sheet steel. Model HQ and HW have an additional two-layer finishing in papyrus white. Ex-models without paint.

□ Impeller

Highly efficient, profiled blade impeller, dynamically balanced and manufactured from impact resistant polymers. Suitable for -30 to +60 °C. Deviation for ex-models.

□ Motor

Totally enclosed motor with a die-cast aluminium casing, protected to IP 55. Ball bearing mounted. Maintenance-free and interference-free. Humidity protection of windings. For maximum air flow temp. see table below. Deviation for ex-models.

□ Motor protection

All models (explosion proof excluded) have thermal contacts as standard which must be connected to a motor protection unit (see below).

□ Electrical connection

Terminal box (IP 55) mounted on rear of motor as standard. Also on outside of piping for HRF. Deviation for ex-models.

□ Guard

Powder-coated steel wire for HQ and HW (HQ ex-models galvanised) according to DIN EN ISO 13857

□ Speed control

For all speed controllable models the current are identified with a value in the "speed controlled" column of the table below which must be used when selecting a controller. Possible allocations of frequency inverters are specified in the table below. The planned

use of a frequency inverter without Sine filter must be stated when ordering. This requires a change of fan design and potential additional costs. The air flow rates are shown in the performance curves.

□ Reversed operation

All models are reversible when wired to a reversing switch. For reverse air flow direction allow a loss in performance of approx. 1/3.

□ Installation

Installation in any position. Ensure that the motor drainage holes face downwards.

□ Dimensions

Pole-switch and explosion proof models may deviate from the information above.

□ Sound levels

See characteristic curve. The sound power and sound pressure are specified at 4 m distances under free field conditions, for average operating point suction/pressure side. See page 10 on for sound emission and acoustics. Deviation for ex-models.

■ Information Page

Techn. description	140
Selection chart	141
Information for planning	10 on

Made to order designs

Alternative voltages, protection classes, air flow direction, air flow temperature, acid protection and cast aluminium impellers are available on request.

Note the technical information on page 15 on.

R.P.M.	Air flow volume (FID)	Motor power	Current*		Wiring diagram	max. air flow temp.		Weight net	Model					
			standard-supply	max. controlled		standard supply	speed controlled		HQ incl. guard	Ref. no.	HW incl. guard	Ref. no.	HRF	Ref. no.
min ⁻¹	V m ³ /h	W	A	A	No.	+°C	+°C	kg						
1 Phase motor, 230 Volt / 50 Hz, capacitor motor, protection to IP 55														
930	2570	77	0.52	0.54	475 ¹⁾	60	40	13.0	HQW 400/6	1110	—	—	HRFW 400/6 ¹⁾	0206
1350	4010	235	1.00	1.10	475 ¹⁾	60	40	14.0	HQW 400/4	1111	HWW 400/4	1008	HRFW 400/4 ¹⁾	0207
3 Phase motor, 400 Volt / 50 Hz, squirrel cage motor protection to IP 55														
950	2620	89	0.28	0.30	469	60	40	13.0	HQD 400/6	1123	—	—	—	—
1330	3960	200	0.40	0.40	469	60	40	14.0	HQD 400/4	1124	HWD 400/4	1025	HRFD 400/4	0229
Two-speed, 3 ph., 400 V, 50 Hz, Y/Δ switch, protection to IP 55														
1325/1085	3170/3920	135/205	0.25/0.45	0.45	520	60	40	20.0	HQD 400/4/4	1465	—	—	HRFD 400/4/4	1466
2890/2600	7890/8400	1300/2310*	3.00/5.60*	4.70	520	40	40	25.0	HQD 400/2/2	1475	—	—	HRFD 400/2/2	1474
2 speed motor, pole-switching, Dahlander windings, 400 Volt, 50 Hz, protection to IP 55														
690/1390	2010/4100	70/250	0.25/0.60	—	472	60	—	13.0	HQD 400/8/4	1137	—	—	HRFD 400/8/4	0399
1480/2940	4180/8540	300/2310*	1.00/5.20*	—	472	40	—	24.0	HQD 400/4/2	1139	—	—	HRFD 400/4/2	0401
Explosion proof Ex e II, 3 ph., 400 Volt, 50 Hz, protection to IP 55, temp. class T1-T3														
920	2870	250*	0.97*	—	470	40	—	13.0	HQD 400/6 Ex	1109	—	—	—	—
1370	4380	370*	1.08*	—	470	40	—	16.0	HQD 400/4 Ex	1153	—	—	HRFD 400/4 Ex	0479

* Motor nominal values, Ex see info page 16.

¹⁾ Type HRFW: connect using wiring diagram no. SS-965.

²⁾ Incl. full motor protection.

³⁾ Incl. pole switch.

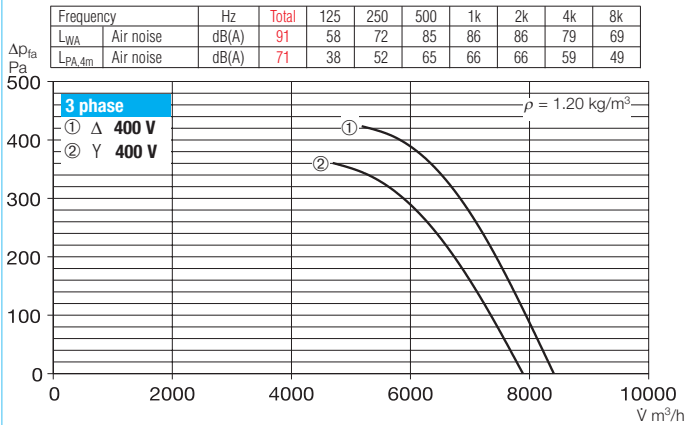
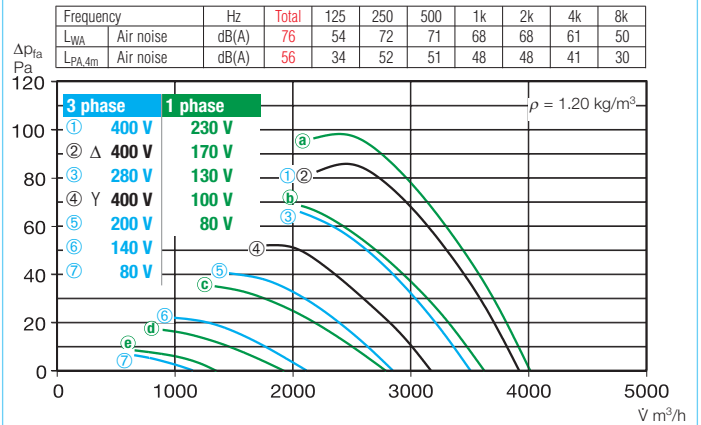
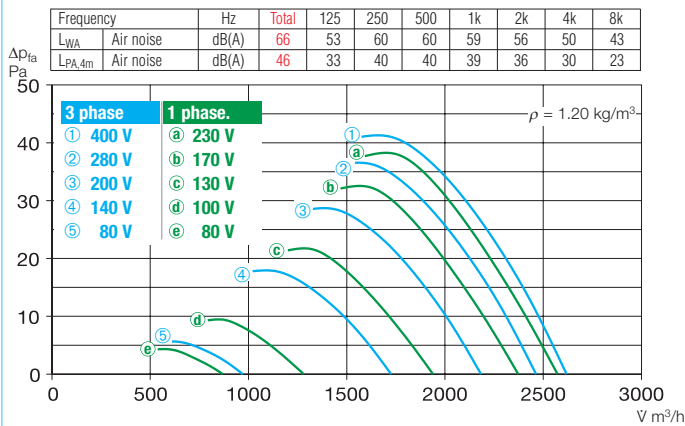
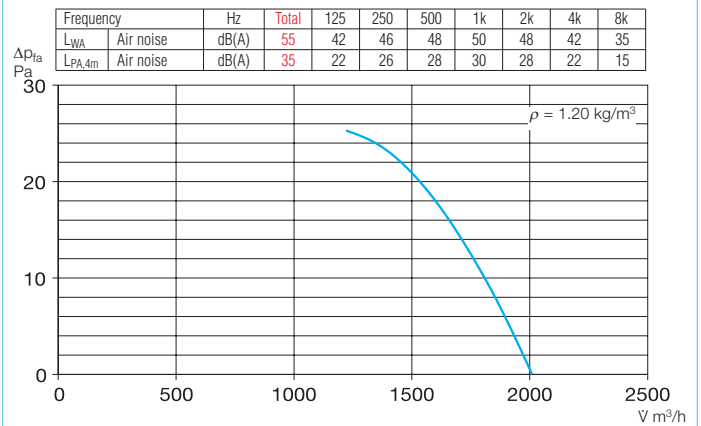
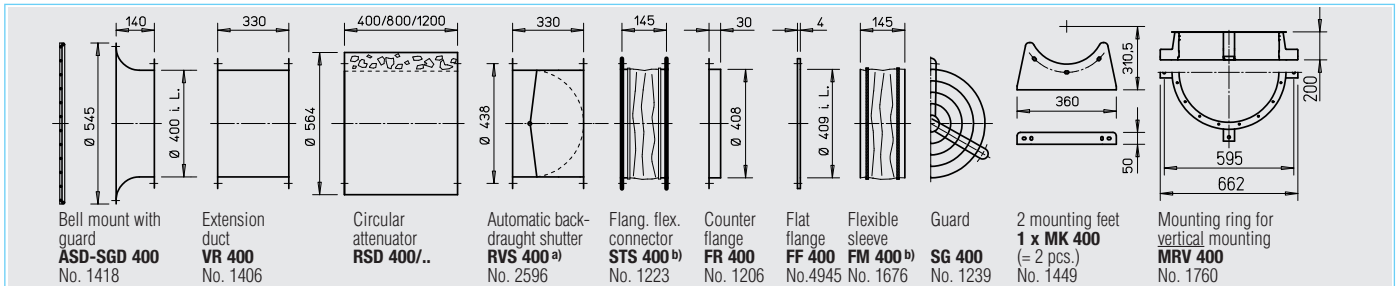
400/2

400/4

400/6

400/8

Accessories for HRF Description see page 230 on

^{a)} For motorised shutters see accessory page

^{b)} Models for ex-proof fans see below

Frequency inverter with integrated Sine filter		Transformer controller 5-speed Pole switch		Electronic controller, stepless flush/surf.		Full motor protection for connection of integrated thermal contacts		Reversing switch	
Model	Ref. no.	Model	Ref. no.	Model	Ref. no.	Model	Ref. no.	Model	Ref. no.
—	—	MWS 1,5 ²⁾	1947	ESU 1/ESA 1	0236/0238	MW	1579	WS	1271
—	—	MWS 1,5 ²⁾	1947	ESU 3/ESA 3	0237/0239	MW	1579	WS	1271
FU-BS 2,5 ²⁾	5459	RDS 1 ²⁾	1314	—	—	MD	5849	WS	1271
FU-BS 2,5 ²⁾	5459	RDS 1 ²⁾	1314	—	—	MD	5849	WS	1271
Speed switch									
FU-BS 2,5 ²⁾	5459	RDS 1 ²⁾	1314	—	—	M 4 ⁴⁾ /MD	1571/5849	WS	1271
FU-BS 5 ²⁾	5460	DS 2	1351	ESD 5 ²⁾	0501	M 4 ⁴⁾ /MD	1571/5849	WS	1271
Pole switch									
—	—	PDA 12 ⁴⁾	5081	—	—	M 3 ³⁾	1293	PWDA	1282
—	—	PDA 12 ⁴⁾	5081	—	—	M 3 ³⁾	1293	PWDA	1282
—	—	not permitted	not permitted	not permitted	not permitted	—	—	—	—
—	—	not permitted	not permitted	not permitted	not permitted	—	—	—	—

⁴⁾ see switch product page for flush mounted version.

Other accessories Page

^{b)} Accessories for explosion proof fans
 Flanged flexible connector Type STS 400 Ex Ref. no. 2505
 Flexible sleeve Type FM 400 Ex Ref. no. 1692

Extension tube for HS Type VH 400 Ref. no. 1346
 Cylindrical duct, galvanised steel, length: 150 mm.

Attenuators 421 on
 Shutters and grilles 487 on
 Speed controllers and switches 525 on

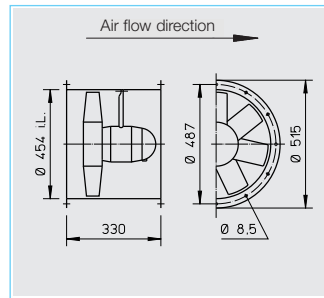
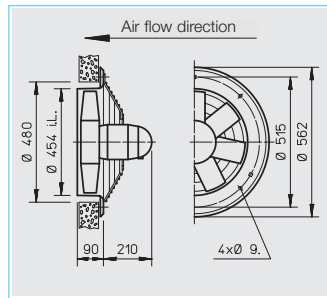
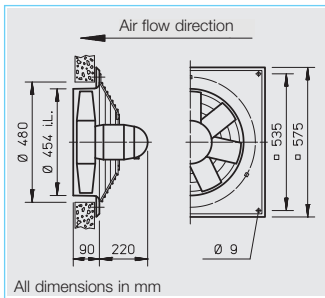

■ Specification for all models

□ Casing

Manufactured in galvanised sheet steel. Model HQ and HW have an additional two-layer finishing in papyrus white. Ex-models without paint.

□ Impeller

Highly efficient, profiled blade impeller, dynamically balanced and manufactured from impact resistant polymers. Suitable for -30 to +60 °C. Deviation for ex-models.

□ Motor

Totally enclosed motor with a die-cast aluminium casing, protected to IP 55. Ball bearing mounted. Maintenance-free and interference-free. Humidity protection of windings. For maximum air flow temp. see table below. Deviation for ex-models.

□ Motor protection

All models (explosion proof excluded) have thermal contacts as standard which must be connected to a motor protection unit (see below).

□ Electrical connection

Terminal box (IP 55) mounted on rear of motor as standard. Also on outside of piping for HRF. Deviation for ex-models.

□ Guard

Powder-coated steel wire for HQ and HW (HQ ex-models galvanised) according to DIN EN ISO 13857.

□ Speed control

For all speed controllable models the current are identified with a value in the "speed controlled" column of the table below which must be used when selecting a controller. Possible allocations of frequency inverters are specified in the table below. The planned use of a frequency inverter without Sine filter must be stated when ordering. This requires a change of fan design and potential additional costs. The air flow rates are shown in the performance curves.

□ Reversed operation

All models are reversible when wired to a reversing switch. For reverse air flow direction allow a loss in performance of approx. 1/3.

□ Installation

Installation in any position. Ensure that the motor drainage holes face downwards.

□ Dimensions

Pole-switch and explosion proof models may deviate from the information above.

□ Sound levels

See characteristic curve. The sound power and sound pressure are specified at 4 m distances under free field conditions, for average operating point suction/pressure side. See page 10 on for sound emission and acoustics. Deviation for ex-models.

R.P.M.	Air flow volume (FID)	Motor power	Current* standard-supply	max. controlled	Wiring diagram	max. air flow temp. standard supply	speed controlled	Weight net	Model					
									HQ incl. guard	Ref. no.	HW incl. guard	Ref. no.	HRF	Ref. no.
min ⁻¹	V m ³ /h	W	A	A	No.	+°C	+°C	kg						
1 Phase motor, 230 Volt / 50 Hz, capacitor motor, protection to IP 55														
915	3890	136	0.63	0.63	475 ¹⁾	60	40	19.0	HQW 450/6	0991	—	—	HRFW 450/6 ¹⁾	0208
1380	5770	405	1.76	2.02	475 ¹⁾	60	40	18.0	HQW 450/4	0992	HWW 450/4	1010	HRFW 450/4 ¹⁾	0209
3 Phase motor, 400 Volt / 50 Hz, squirrel cage motor protection to IP 55														
960	3920	137	0.38	0.42	469	60	40	18.0	HQD 450/6	0993	—	—	HRFD 450/6	0230
1390	5810	384	0.81	0.92	469	50	40	17.0	HQD 450/4	0994	HWD 450/4	1028	HRFD 450/4	0231
Two-speed, 3 ph., 400 V, 50 Hz, Y/Δ switch, protection to IP 55														
1130/1390	5090/5780	280/378	0.51/0.82	—	520	60	—	22.0	HQD 450/4/4	1467	—	—	HRFD 450/4/4	1468
2775/2200	10190/9335	1300/2310*	5.40/3.0*	5.10	520	40	40	32.0	—	—	—	—	HRFD 450/2/2	0484
2 speed motor, pole-switching, Dahlander windings, 400 Volt, 50 Hz, protection to IP 55														
480/970	1930/3950	62/163	0.22/0.47	—	472	60	—	18.0	HQD 450/12/6	0995	—	—	—	—
705/1410	2860/5810	91/404	0.36/0.92	—	472	50	—	20.0	HQD 450/8/4	0996	—	—	HRFD 450/8/4	0403
Explosion proof Ex e II, 3 ph., 400 Volt, 50 Hz, protection to IP 55, temp. class T1-T3														
920	4090	250*	0.97*	—	470	40	—	15.5	HQD 450/6 Ex	1473	—	—	—	—
1370	6240	370*	1.08*	—	470	40	—	15.5	HQD 450/4 Ex	1154	—	—	HRFD 450/4 Ex	0481

* Motor nominal values, Ex see info page 16.

¹⁾ Type HRFW: connect using wiring diagram no. SS-965.

²⁾ Incl. full motor protection.

³⁾ see switch product page for flush mounted version.

450/2

Frequency		Hz	Total	125	250	500	1k	2k	4k	8k
L _{WA}	Air noise	dB(A)	98	72	89	91	96	90	87	79
L _{PA,4m}	Air noise	dB(A)	78	52	69	71	76	70	67	59

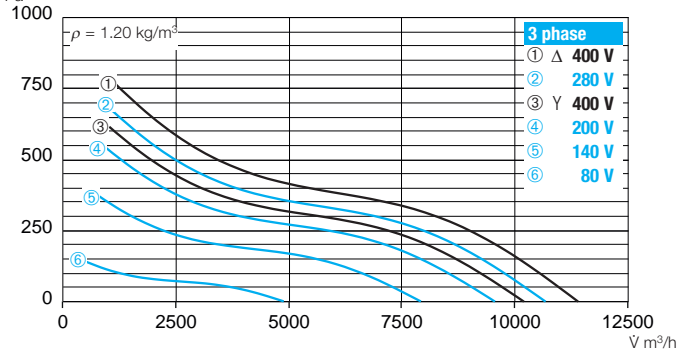

450/4

Frequency		Hz	Total	125	250	500	1k	2k	4k	8k
L _{WA}	Air noise	dB(A)	78	52	69	72	73	72	67	60
L _{PA,4m}	Air noise	dB(A)	58	32	49	52	53	52	47	40

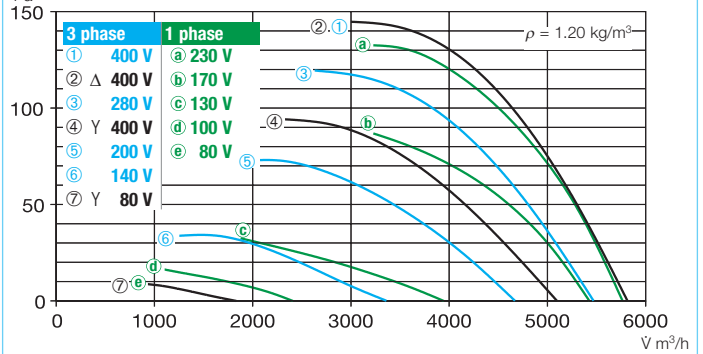

450/6

Frequency		Hz	Total	125	250	500	1k	2k	4k	8k
L _{WA}	Air noise	dB(A)	68	52	58	62	63	61	56	47
L _{PA,4m}	Air noise	dB(A)	48	32	38	42	43	41	36	27

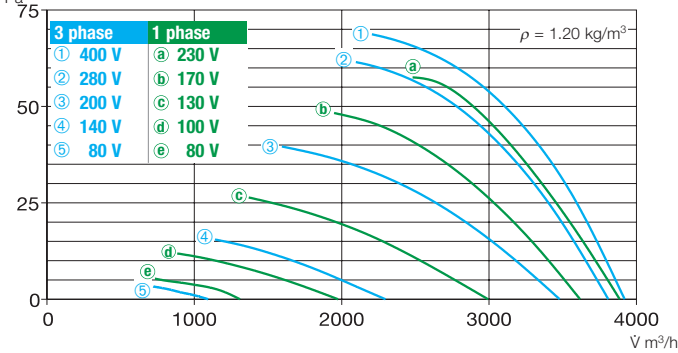

450/8

Frequency		Hz	Total	125	250	500	1k	2k	4k	8k
L _{WA}	Air noise	dB(A)	78	52	69	73	73	72	67	60
L _{PA,4m}	Air noise	dB(A)	58	32	49	53	53	52	47	40

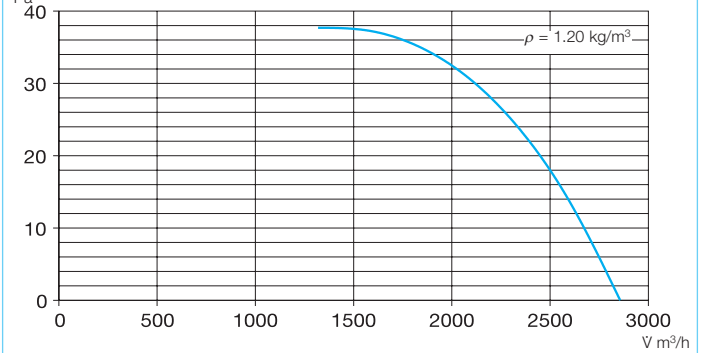

Accessories for HRF Description see page 230 on

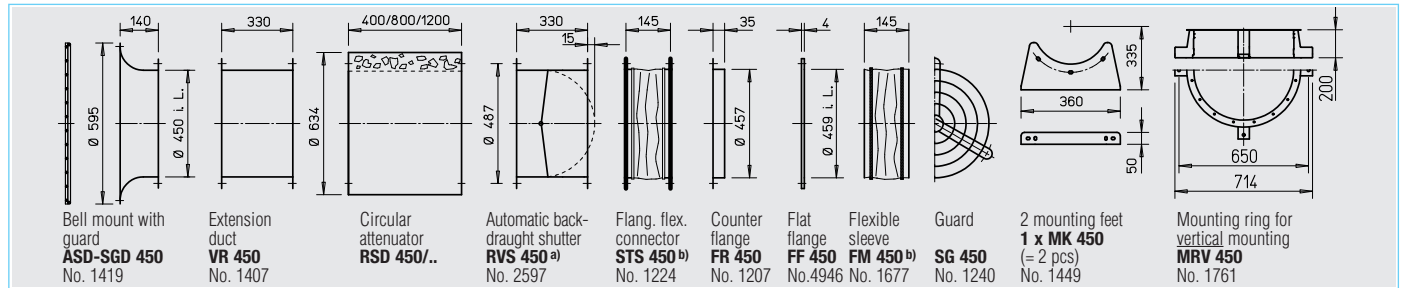

^{a)} For motorised shutters see accessory page

^{b)} Models for ex-proof fans see below

Frequency inverter with integrated Sine filter		Transformer controller 5-speed Pole switch		Electronic controller, stepless flush/surf.		Full motor protection for connection of integrated thermal contacts		Reversing switch	
Model	Ref. no.	Model	Ref. no.	Model	Ref. no.	Model	Ref. no.	Model	Ref. no.
—	—	MWS 1,5 ²⁾	1947	ESU 3/ESA 3	0237/0239	MW	1579	WS	1271
—	—	MWS 3 ²⁾	1948	ESU 3/ESA 3	0237/0239	MW	1579	WS	1271
FU-BS 2,5 ²⁾	5459	RDS 1 ²⁾	1314	—	—	MD	5849	WS	1271
FU-BS 2,5 ²⁾	5459	RDS 2 ²⁾	1315	ESD 5 ²⁾	0501	MD	5849	WS	1271
FU-BS 2,5 ²⁾	5459	DS 2 ⁵⁾	1351	—	—	M 4 ⁴⁾ /MD	1571/5849	WS	1271
FU-BS 8,0 ²⁾	5461	RDS 7 ²⁾	1578	ESD 11,5 ²⁾	0502	M 4 ⁴⁾ /MD	1571/5849	WS	1271
—	—	PDA 12 ³⁾	5081	—	—	M 3 ⁴⁾	1293	PWDA	1282
—	—	PDA 12 ³⁾	5081	—	—	M 3 ⁴⁾	1293	PWDA	1282
—	—	not permitted	not permitted	not permitted	not permitted	—	—	—	—
—	—	not permitted	not permitted	not permitted	not permitted	—	—	—	—

⁴⁾ Incl. pole switch.

⁵⁾ Speed switch.

Other accessories Page

^{b)} Accessories for explosion proof fans	
Flanged flexible connector Type STS 450 Ex	Ref. no. 2506
Flexible sleeve Type FM 450 Ex	Ref. no. 1693
Attenuators	421 on
Shutters and grilles	487 on
Speed controllers and switches	525 on

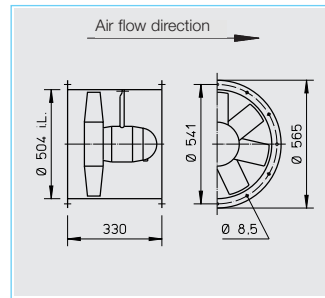
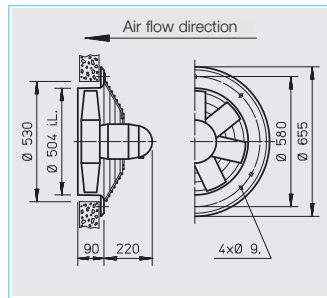
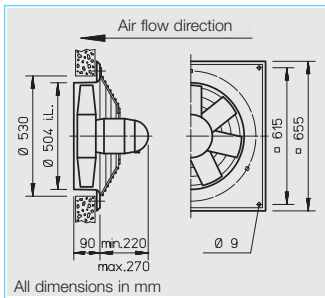

■ Specification for all models

□ Casing

Manufactured in galvanised sheet steel. Model HQ and HW have an additional two-layer finishing in papyrus white. Ex-models without paint.

□ Impeller

Highly efficient, profiled blade impeller, dynamically balanced and manufactured from impact resistant polymers. Suitable for -30 to +60 °C. Deviation for ex-models.

□ Motor

Totally enclosed motor with a die-cast aluminium casing, protected to IP 55. Ball bearing mounted. Maintenance-free and interference-free. Humidity protection of windings. For maximum air flow temp. see table below. Deviation for ex-models.

□ Motor protection

All models (explosion proof excluded) have thermal contacts as standard which must be connected to a motor protection unit (see below).

□ Electrical connection

Terminal box (IP 55) mounted on rear of motor as standard. Also on outside of piping for HRF. Deviation for ex-models.

□ Guard

Powder-coated steel wire for HQ and HW (HQ ex-models galvanised) according to DIN EN ISO 13857.

□ Speed control

For all speed controllable models the current are identified with a value in the "speed controlled" column of the table below which must be used when selecting a controller. Possible allocations of

frequency inverters are specified in the table below. The planned use of a frequency inverter without Sine filter must be stated when ordering. This requires a change of fan design and potential additional costs. The air flow rates are shown in the performance curves.

□ Reversed operation

All models are reversible when wired to a reversing switch. For reverse air flow direction allow a loss in performance of approx. 1/3.

□ Installation

Installation in any position. Ensure that the motor drainage holes face downwards.

□ Dimensions

Pole-switch and explosion proof models may deviate from the information above.

□ Sound levels

See characteristic curve. The sound power and sound pressure are specified at 4 m distances under free field conditions, for average operating point suction/pressure side. See page 10 on for sound emission and acoustics. Deviation for ex-models.

Information	Page
Techn. description	140
Selection chart	141
Information for planning	10 on

Made to order designs
Alternative voltages, protection classes, air flow direction, air flow temperature, acid protection and cast aluminium impellers are available on request.

R.P.M.	Air flow volume (FID)	Motor power	Current* standard-supply	max. controlled	Wiring diagram	max. air flow temp.		Weight net	Model					
						standard supply	speed controlled		HQ incl. guard	Ref. no.	HW incl. guard	Ref. no.	HRF	Ref. no.
min ⁻¹	V m ³ /h	W	A	A	No.	+°C	+°C	kg						
1 Phase motor, 230 Volt / 50 Hz, capacitor motor, protection to IP 55														
935	5500	233	1.05	1.25	475 ¹⁾	60	40	19.0	HQW 500/6	1112	—	—	HRFW 500/6 ¹⁾	0210
1375	8320	1100*	5.90*	4.94	475 ¹⁾	40	40	25.0	HQW 500/4	1113	—	—	HRFW 500/4 ¹⁾	0211
3 Phase motor, 400 Volt / 50 Hz, squirrel cage motor protection to IP 55														
920	5480	218	0.48	0.55	469	60	40	19.0	HQD 500/6	1126	—	—	HRFD 500/6	0232
1345	8200	620	1.22	1.32	469	40	40	19.5	HQD 500/4	1127	HWD 500/4	1030	HRFD 500/4	0233
Two-speed, 3 ph., 400 V, 50 Hz, Y/Δ switch, protection to IP 55														
615/920	4330/5450	133/214	0.29/0.46	—	520	60	—	18.0	HQD 500/6/6	1471	—	—	—	—
1030/1350	6720/8150	416/617	0.76/1.19	—	520	60	—	24.0	HQD 500/4/4	1469	—	—	HRFD 500/4/4	1470
2450/2830	13615/12050	1960/2470*	3.14/4.73*	—	520	40	—	30.0	—	—	—	—	HRFD 500/2/2	0485
2 speed motor, pole-switching, Dahlander windings, 400 Volt, 50 Hz, protection to IP 55														
465/940	2680/5490	71/248	0.23/0.56	—	472	60	—	18.0	HQD 500/12/6	1140	—	—	—	—
700/1385	3890/8280	137/688	0.52/1.48	—	472	40	—	22.0	HQD 500/8/4	1142	—	—	HRFD 500/8/4	0407
Explosion proof Ex e II, 3 ph., 400 Volt, 50 Hz, protection to IP 55, temp. class T1-T3														
920	5610	250*	0.97*	—	470	40	—	18.0	HQD 500/6 Ex	1050	—	—	HRFD 500/6 Ex	0489
1390	8560	750*	2.00*	—	470	40	—	18.0	HQD 500/4 Ex	1157	—	—	HRFD 500/4 Ex	0483

* Motor nominal values, Ex see info page 16.

¹⁾ Type HRFW: connect using wiring diagram no. SS-965.

²⁾ Incl. full motor protection.

³⁾ Incl. pole switch.

500/2

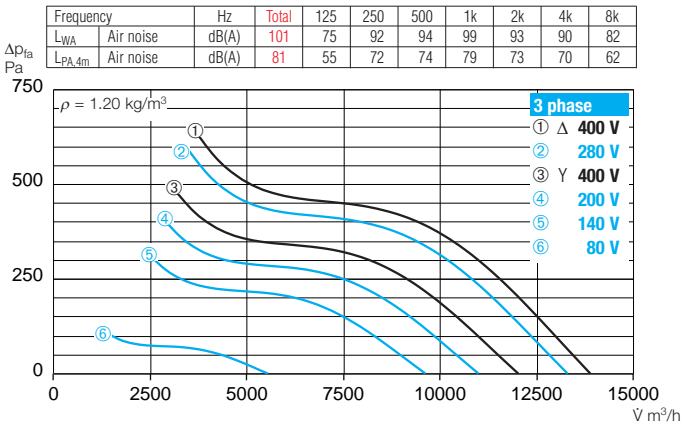

500/4

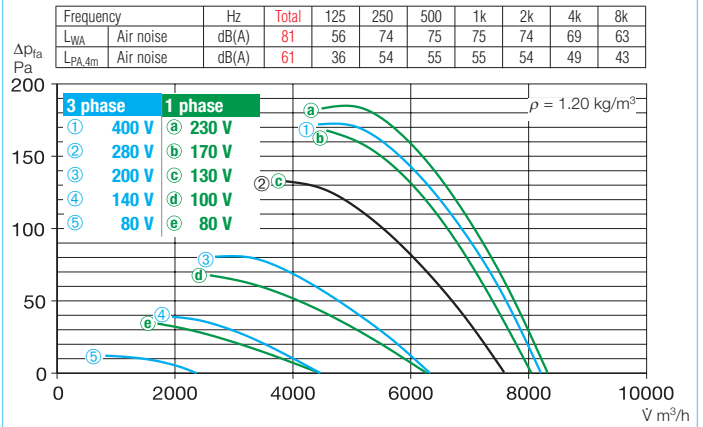

500/6

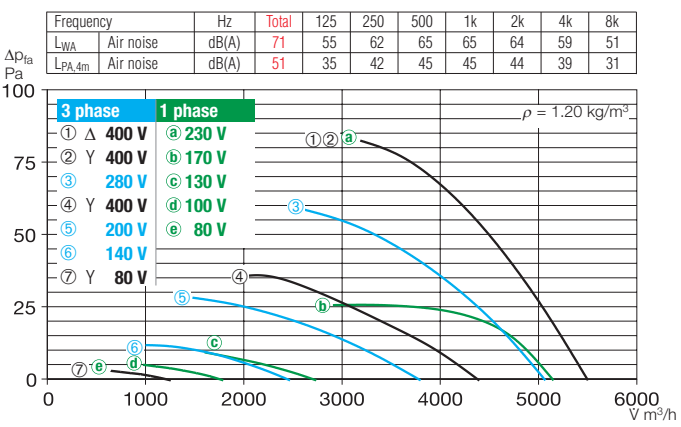

500/8

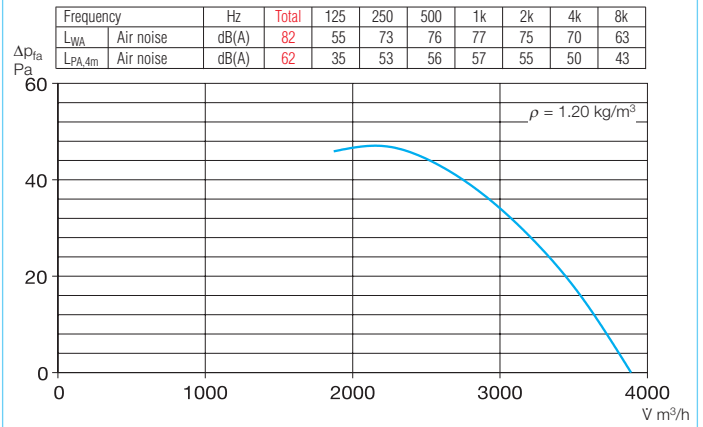

Accessories for HRF Description see page 230 on

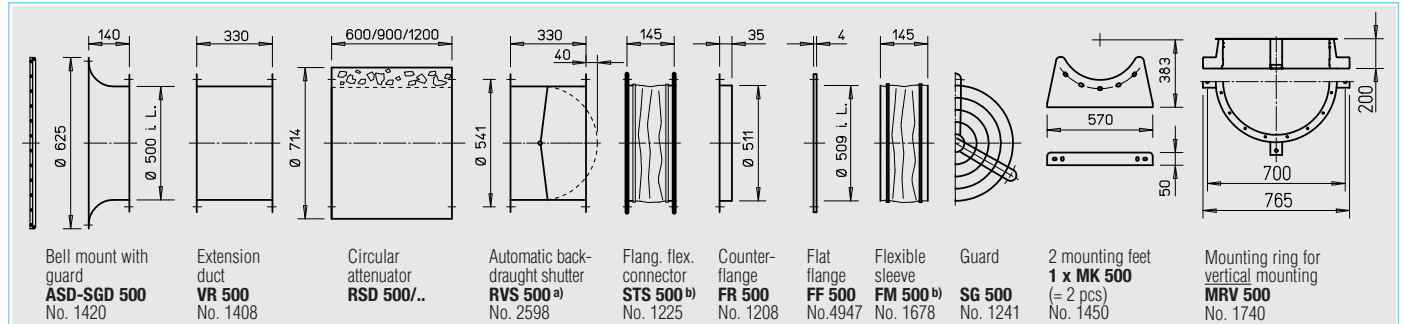

a) For motorised shutters see accessory page

b) Models for ex-proof fans see below

Frequency inverter with integrated Sine filter		Transformer controller 5-speed Pole switch		Electronic controller, stepless flush/surf.		Full motor protection for connection of integrated thermal contacts		Reversing switch	
Model	Ref. no.	Model	Ref. no.	Model	Ref. no.	Model	Ref. no.	Model	Ref. no.
—	—	MWS 1,5 ²⁾	1947	ESU 3/ESA 3	0237/0239	MW	1579	WS	1271
—	—	MWS 5 ²⁾	1949	ESU 5/ESA 5	1296/1299	MW	1579	WS	1271
FU-BS 2,5 ²⁾	5459	RDS 1 ²⁾	1314	ESD 5 ²⁾	0501	MD	5849	WS	1271
FU-BS 2,5 ²⁾	5459	RDS 2 ²⁾	1315	ESD 5 ²⁾	0501	MD	5849	WS	1271
Speed switch									
FU-BS 2,5 ²⁾	5459	DS 2 ⁵⁾	1351	—	—	M 4 ⁴⁾ /MD	1571/5849	WS	1271
FU-BS 2,5 ²⁾	5459	DS 2 ⁵⁾	1351	ESD 5 ²⁾	0501	M 4 ⁴⁾ /MD	1571/5849	WS	1271
FU-BS 5,0 ²⁾	5460	RDS 7 ²⁾	1578	ESD 11,5 ²⁾	0502	M 4 ⁴⁾ /MD	1571/5849	WS	1271
Pole switch									
—	—	PDA 12 ⁴⁾	5081	—	—	M 3 ³⁾	1293	PWDA	1282
—	—	PDA 12 ⁴⁾	5081	—	—	M 3 ³⁾	1293	PWDA	1282
—	—	not permitted	not permitted	not permitted	not permitted	—	—	—	—
—	—	not permitted	not permitted	not permitted	not permitted	—	—	—	—

4) See switch product page for flush mounted version.

5) Speed switch.

Other accessories Page

- Accessories for explosion proof fans
 - Flanged flexible connector Type STS 500 Ex Ref. no. 2507
 - Flexible sleeve Type FM 500 Ex Ref. no. 1694
- Extension tube for HS
 - Type VH 500 Ref. no. 1348
- Cylindrical duct, galvanised steel, length: 150 mm.
- Attenuators 421 on
- Shutters and grilles 487 on
- Speed controllers and switches 525 on

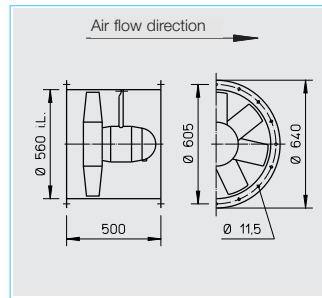
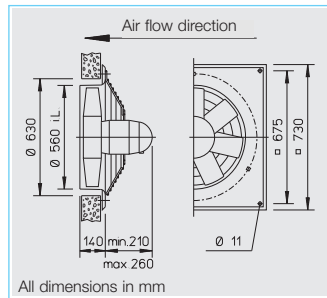

■ Specification for all models

□ Casing

Manufactured in galvanised sheet steel. Model HQ have an additional two-layer finishing in papyrus white. Ex-models with-out paint.

□ Impeller

Highly efficient, profiled blade impeller, dynamically balanced and manufactured from impact resistant polymers. Suitable for -30 to +60 °C. Deviation for ex-models.

□ Motor

Totally enclosed motor with a die-cast aluminium casing, protected to IP 55. Ball bearing mounted. Maintenance-free and interference-free. Humidity protection of windings. For maximum air flow temperature see table below. Deviation for ex-models.

□ Motor protection

All models (except explosion proof) have thermal contacts as standard which must be connected to a motor protection unit (see below) for effective motor protection.

□ Electrical connection

Terminal box (IP 55) mounted on rear of motor as standard. Also on outside of piping for HRF. Deviation for ex-models.

□ Guard

Powder-coated steel wire for HQ (Ex-models galvanised) according to DIN EN ISO 13857.

□ Speed control

For all speed controllable models the current are identified with a value in the "speed controlled" column of the table below which must be used when selecting a controller. Possible allocations of frequency inverters are specified in the table below. The planned use of a frequency inverter without Sine filter must be stated when ordering. This requires a change of fan design and potential additional costs. The air flow rates are shown in the performance curves.

□ Reversed operation

All models are reversible when wired to a reversing switch. For reverse air flow direction allow a loss in performance of approx. 1/3.

□ Installation

Installation in any position. Ensure that the motor drainage holes face downwards.

□ Dimensions

Pole-switch and explosion proof models may deviate from the information above.

□ Sound levels

See characteristic curve. The sound power and sound pressure are specified at 4 m distances under free field conditions, for average operating point suction/pressure side. See page 10 on for sound emission and acoustics. Deviation for ex-models.

R.P.M.	Air flow volume (FID)	Motor power (nominal)*	Current*		Wiring diagram	max. air flow temp.		Weight net	Model				Transformer controller for 5 speed pole switch		Electronic controller, stepless flush/surf.	
			standard-supply	max. controlled		standard supply	speed controlled		HQ incl. guard	Ref. no.	HRF	Ref. no.	Model	Ref. no.	Model	Ref. no.
min ⁻¹	V m ³ /h	kW	A	A	No.	+°C	+°C	kg								
1 Phase motor, 230 Volt / 50 Hz, capacitor motor, protection to IP 55																
935	8130	0.27	1.40	2.00	475 ¹⁾	60	40	24.0	HQW 560/6	0385	HRFW 560/6 ¹⁾	0380	MWS 3 ²⁾	1948	ESU 3/ESA 3	0237/0239
1370	12180	0.89	4.15	5.00	965	60	40	31.0	HQW 560/4	5054	HRFW 560/4	5055	MWS 7,5 ²⁾	1950	ESU 5/ESA 5	1296/1299
3 Phase motor, 400 Volt / 50 Hz, squirrel cage motor protection to IP 55																
965	8180	0.28	0.79	1.00	469	60	40	26.0	HQD 560/6	0386	HRFD 560/6	0381	RDS 2 ²⁾	1315	ESD 5 ²⁾	0501
1365	12250	0.88	1.71	1.80	469	40	40	29.0	HQD 560/4	0387	HRFD 560/4	0382	RDS 2 ²⁾	1315	ESD 5 ²⁾	0501
2 speed motor, pole-switching, Dahlander windings, 400 Volt, 50 Hz, protection to IP 55																
470/955	4000/8130	0.089/0.298	0.55/0.74	—	472	60	—	24.0	HQD 560/12/6	0389	HRFD 560/12/6	0384	PDA 12 ³⁾	5081	—	—
720/1365	6400/12130	0.20/0.92	0.80/1.77	—	472	40	—	26.0	HQD 560/8/4	0388	HRFD 560/8/4	0383	PDA 12 ³⁾	5081	—	—
Explosion proof Ex e II, 3 ph., 400 Volt, 50 Hz, protection to IP 55, temp. class T1-T3																
920	8090	0.25*	0.97*	—	470	40	—	23.0	HQD 560/6 Ex	0378	HRFD 560/6 Ex	0376	not permitted	—	not permitted	—
1390	12890	0.75*	2.00*	—	470	40	—	24.0	HQD 560/4 Ex	0379	HRFD 560/4 Ex	0377	not permitted	—	not permitted	—

* Ex-models: for nominal value of motor see information on page 16 ¹⁾ Type HRFW: connect using wiring diagram no. SS-965 ²⁾ Incl. full motor protection ³⁾ see switch product page for flush mounted version

560/4

Frequency		Hz	Total	125	250	500	1k	2k	4k	8k
L _{WA}	Air noise	dB(A)	82	66	68	74	78	78	74	68
L _{PA,4m}	Air noise	dB(A)	65	46	48	54	58	58	54	48

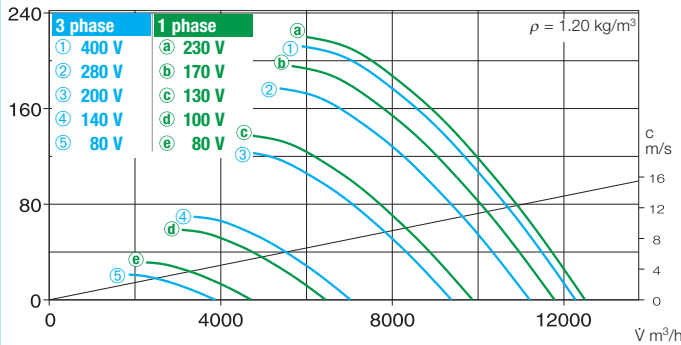

560/6

Frequency		Hz	Total	125	250	500	1k	2k	4k	8k
L _{WA}	Air noise	dB(A)	72	52	59	66	68	67	63	53
L _{PA,4m}	Air noise	dB(A)	52	32	39	46	48	47	43	33

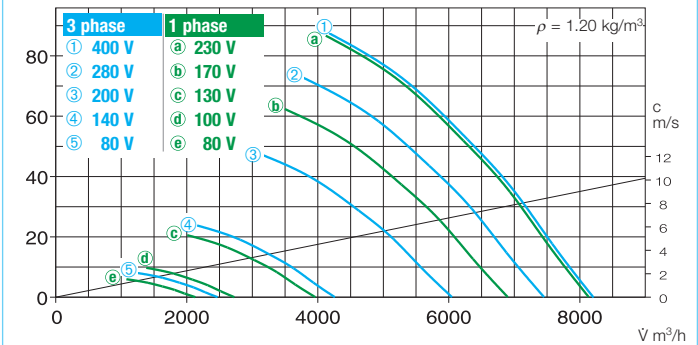

560/8

Frequency		Hz	Total	125	250	500	1k	2k	4k	8k
L _{WA}	Air noise	dB(A)	82	66	68	74	78	78	74	68
L _{PA,4m}	Air noise	dB(A)	65	46	48	54	58	58	54	48

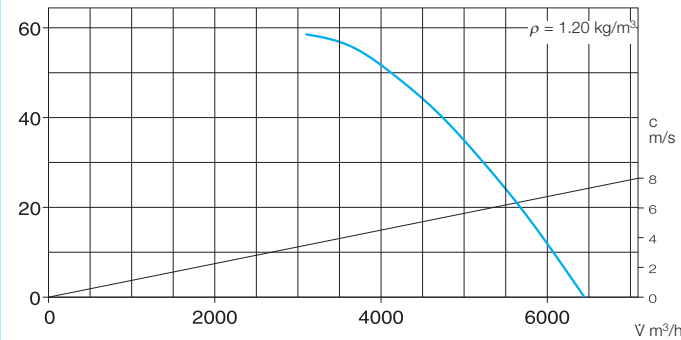

560/12

Frequency		Hz	Total	125	250	500	1k	2k	4k	8k
L _{WA}	Air noise	dB(A)	72	52	59	66	68	67	63	53
L _{PA,4m}	Air noise	dB(A)	52	32	39	46	48	47	43	33

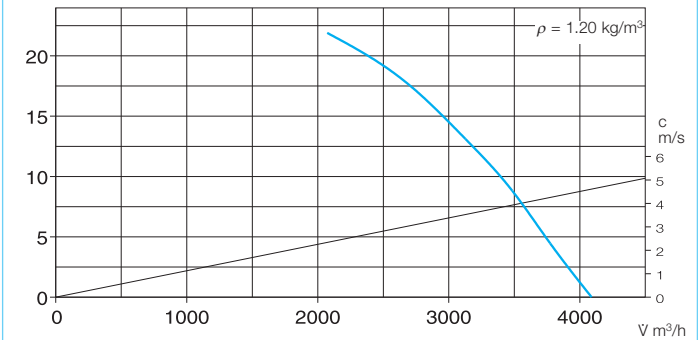

Accessories for HRF Description see page 230 on

Bell mount + guard ASD-SGD 560 No. 1421	Extension duct VR 560 No. 1409	Circular attenuators RSD 560/..	Automatic back-draught shutter RVS 560 a) No. 2599	Flang. flex. connector STS 560 b) No. 1226	Counter-flange FR 560 No. 1209	Flat flange FF 560 No. 4948	Flexible sleeve FM 560 b) No. 1679	Guard SG 560 No. 1242	2 mounting feet 1 x MK 560 (= 2 pcs.) No. 1450	Mounting ring for vertical mounting MRV 560 No. 1741

a) For motorised shutters see accessory page

b) Models for ex-proof fans see below

Electronic controller for stepless control		Full motor protection starter using the motor thermal contacts		Reversing switch	
Model	Ref. no.	Model	Ref. no.	Model	Ref. no.
—	—	MW	1579	WS	1271
—	—	MW	1579	WS	1271
FU-BS 2,5²⁾	5459	MD	5849	WS	1271
FU-BS 2,5²⁾	5459	MD	5849	WS	1271
—	—	M 3⁴⁾	1293	PWDA	1282
—	—	M 3⁴⁾	1293	PWDA	1282
—	—	—	—	—	—
—	—	—	—	—	—

4) Incl. pole switch

Information	Page	Other accessories	Page
Techn. description	140	Accessories for explosion proof fans	
Selection chart	141	Flanged flexible connector	
Information for planning	10 on	Type STS 560 Ex	Ref. no. 2508
Made to order designs		Flexible sleeve	
Alternative voltages, protection classes, air flow direction, air flow temperature, acid protection and cast aluminium impellers are available on request.		Type FM 560 Ex	Ref. no. 1695
Note the technical information on page 15 on.		Attenuators	434 on
		Shutter and grilles	487 on
		Speed controllers and switches	525 on

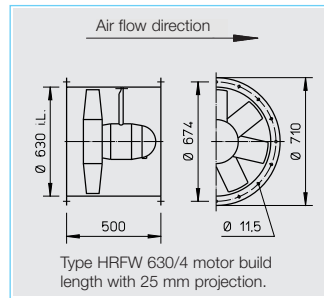
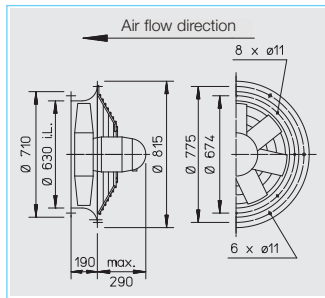
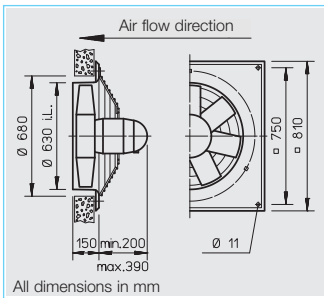

- **Specification for all models**
- **Casing**
Manufactured in galvanised sheet steel.
- **Impeller**
Highly efficient, profiled blade impeller, dynamically balanced and manufactured from impact resistant polymers. Suitable for -30 to +60 °C. Deviation for ex-models.
- **Motor**
Totally enclosed motor with a die-cast aluminium casing, protected to IP 55. Ball bearing mounted. Maintenance-free and interference-free. Humidity protection of windings. For maximum air flow temperature see table below. Deviation for ex-models.

- **Motor protection**
All models (except ../8/4 and explosion proof) have thermal contacts as standard which must be connected to a motor protection unit (see below) for effective motor protection. Motors without thermal contacts must be protected by a conventional circuit breaker.
- **Electrical connection**
Terminal box (IP 55) mounted on motor as standard. Also on outside of piping for HRF. Deviation for ex-models.
- **Guard**
Powder-coated steel wire for HQ and HW (HQ.. Ex galvanised) according to DIN EN ISO 13857.

- **Speed control**
For all speed controllable models the current are identified with a value in the "speed controlled" column of the table below which must be used when selecting a controller. Possible allocations of frequency inverters are specified in the table below. The planned use of a frequency inverter without Sine filter must be stated when ordering. This requires a change of fan design and potential additional costs. The air flow rates are shown in the performance curves.
- **Reversed operation**
All models are reversible when wired to a reversing switch. For reverse air flow directional- low a loss in performance of approx. 1/3.

- **Installation**
Installation in any position. Ensure that the motor drainage holes face downwards.
- **Dimensions**
Pole-switch and explosion proof models may deviate from the information above.
- **Sound levels**
See characteristic curve. The sound power and sound pressure are specified at 4 m distances under free field conditions, for average operating point suction/pressure side. See page 10 on for sound emission and acoustics. Deviation for ex-models.

R.P.M.	Air flow volume (FID)	Motor power (nominal)*	Current*		Wiring diagram	max. air flow temp. standard supply	speed controlled	Weight net	Model				Transformer controller for 5 speed pole switch			
			standard-supply	max. controlled					HQ incl. guard	Ref. no.	HW incl. guard	Ref. no.	HRF	Ref. no.	Model	Ref. no.
min ⁻¹	V m ³ /h	kW	A	A	No.	+°C	+°C	kg								
1 Phase motor, 230 Volt / 50 Hz, capacitor motor, protection to IP 55																
950	10530	0.44	2.16	3.20	475	60	40	28.0	HQW 630/6	5037	—	—	—	—	MWS 3 ¹⁾	1948
1325	16210	1.50*	8.40*	7.00	964	40	—	40.0	HQW 630/4	5056	—	—	HRFW 630/4	5057	MWS 7,5 ¹⁾	1950
3 Phase motor, 400 Volt / 50 Hz, squirrel cage motor protection to IP 55																
710	7810	0.20	0.66	0.70	469	40	40	27.0	HQD 630/8	5029	—	—	—	—	RDS 2 ¹⁾	1315
960	10560	0.44	1.22	—	469	60	40	30.5	HQD 630/6	5027	HWD 630/6	1032	HRFD 630/6	0244	RDS 2 ¹⁾	1315
Two-speed, 3 ph., 400 V, 50 Hz, Y/Δ switch, protection to IP 55																
1170/1390	14310/17000	0.90/1.57	2.3/3.8	—	520	40	—	37.5	HQD 630/4/4	5030	HWD 630/4/4	1033	HRFD 630/4/4	0245	RDS 4 ¹⁾	1316
2 speed motor, pole-switching, Dahlander windings, 400 Volt, 50 Hz, protection to IP 55																
440/935	5290/10470	0.14/0.43	0.60/1.13	—	472	60	—	41.0	HQD 630/12/6	5031	—	—	HRFD 630/12/6	0410	PDA 12 ²⁾	5081
690/1400	7990/15990	0.37/1.50*	1.33/3.70*	—	471	40	—	40.5	HQD 630/8/4	5032	—	—	HRFD 630/8/4	0411	PDA 12 ²⁾	5081
Explosion proof Ex e II, 3 ph., 400 Volt, 50 Hz, protection to IP 55, temp. class T1-T3																
910	10480	0.55*	1.75*	—	470	40	—	30.0	HQD 630/6 Ex	5035	—	—	HRFD 630/6 Ex	0494	not permitted	
1410	17730	1.35*	3.10*	—	470	40	—	35.0	HQD 630/4 Ex	5036	—	—	HRFD 630/4 Ex	0495	not permitted	

* Ex-models: for nominal value of motor see information on page 16 ¹⁾ Incl. full motor protection ²⁾ see switch product page for flush mounted version

630/4

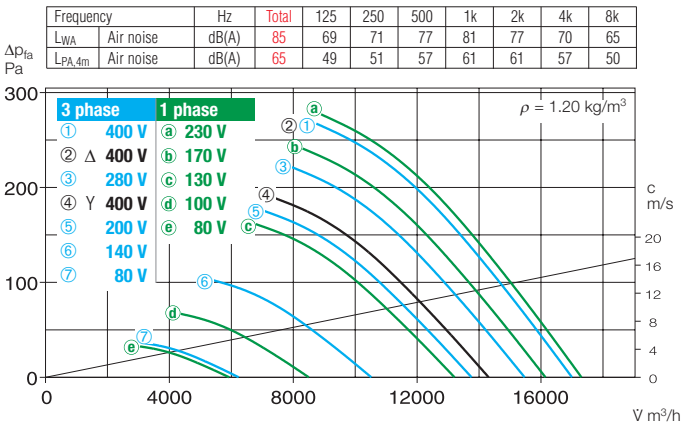

630/6

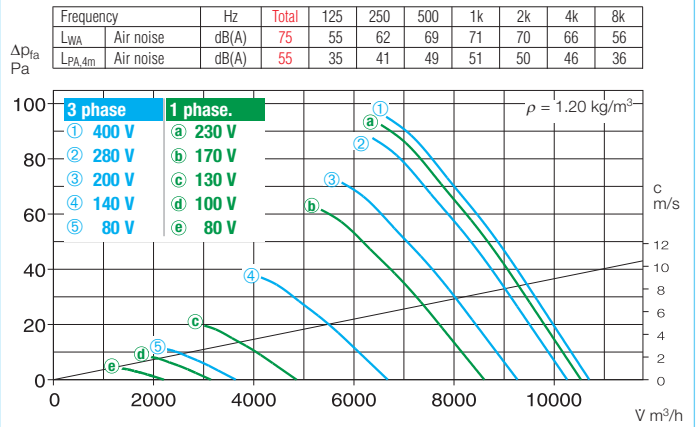

630/8

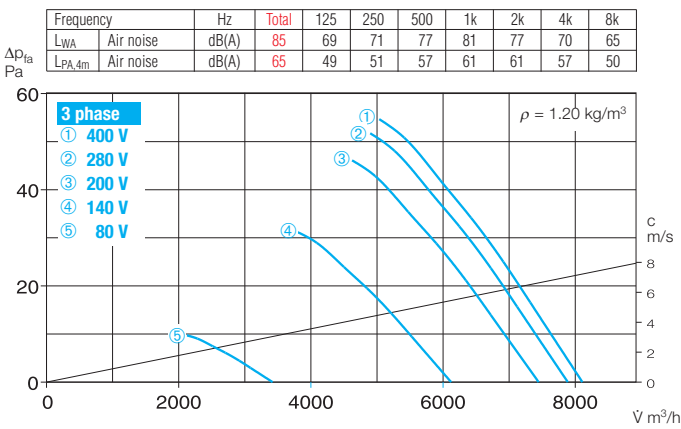

630/12

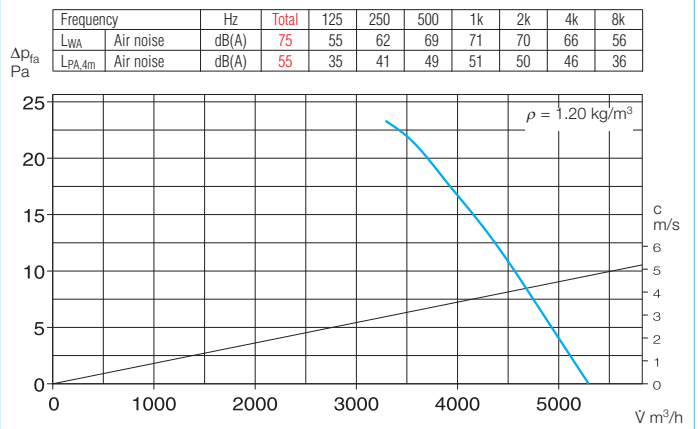

Accessories for HRF Description see page 230 on

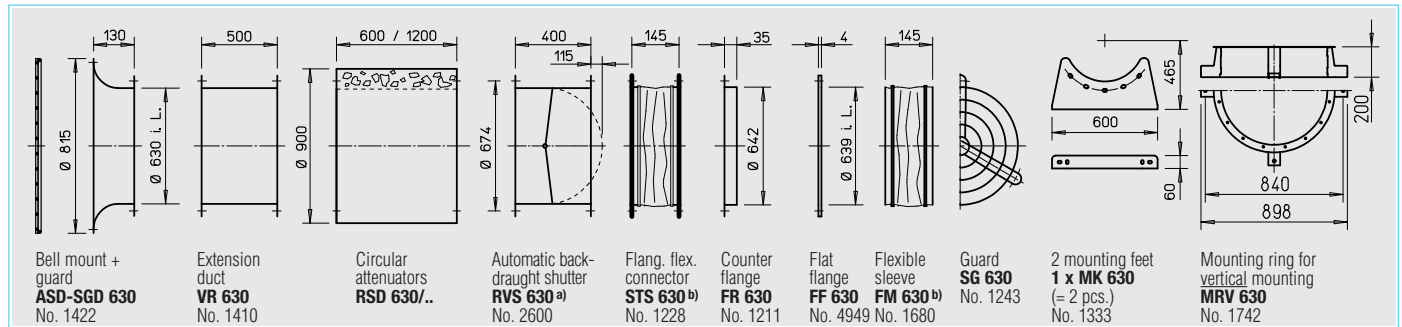

^{a)} For motorised shutters see accessory page

^{b)} Models for ex-proof fans see below

Frequency inverter with integrated Sine filter		Electronic controller, stepless flush/surf.		Full motor protection for connection of integrated thermal contacts		Reversing switch	
Model	Ref. no.	Model	Ref. no.	Model	Ref. no.	Model	Ref. no.
—	—	ESU 5/ESA 5	1296/1299	MW	1579	WS	1271
—	—	—	—	MW	1579	WS	1271
FU-BS 2,5¹⁾	5459	ESD 5¹⁾	0501	MD	5849	WS	1271
FU-BS 2,5¹⁾	5459	ESD 5¹⁾	0501	MD	5849	WS	1271
FU-BS 5,0¹⁾	5460	ESD 5¹⁾	0501	M 4³⁾	1571	WS	1271
—	—	—	—	M 3³⁾	1293	PWDA	1282
—	—	—	—	M 3³⁾	1293	PWDA	1282
—	—	not permitted	—	—	—	—	—
—	—	not permitted	—	—	—	—	—

³⁾ Incl. pole switch

Information	Page	Other accessories	Page
Techn. description	140	^{b)} Accessories for explosion proof fans	
Selection chart	141	Flanged flexible connector	
Information for planning	10 on	Type STS 630 Ex	Ref. no. 2509
Made to order designs		Flexible sleeve	
Alternative voltages, protection classes, air flow direction, air flow temperature, acid protection and cast aluminium impellers are available on request.		Type FM 630 Ex	Ref. no. 1696
Note the technical information on page 15 on.		Attenuators	434 on
		Shutter and grilles	487 on
		Speed controllers and switches	525 on

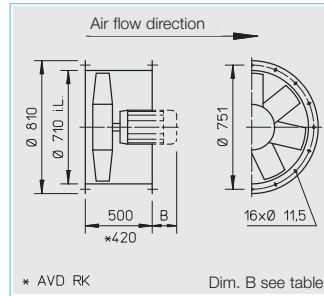
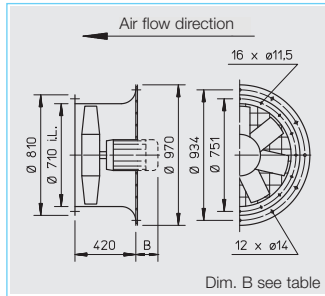
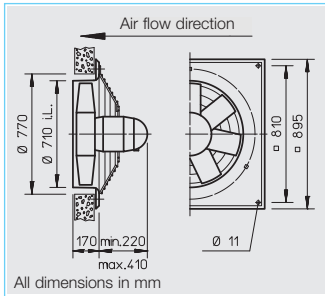
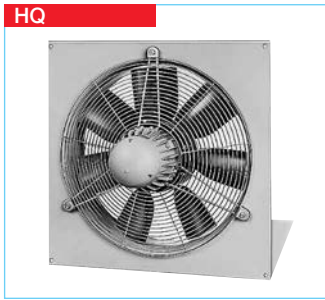

■ Specification for all models

□ Casing
With motor support manufactured from galvanised sheet steel.

□ Impeller
Highly efficient, profiled blade impeller, dynamically balanced and manufactured from impact resistant polymers. Suitable for -30 to +60 °C. Deviation for ex-models.

□ Pitch angle
The impeller blades are adjustable for the optimal coverage of the operating point (except HQW 710/6 and explosion proof). The pitch angle is set at the factory (according to the

order) and fixed. The motor allocation takes place using the maximum power pursuant to the information in the table below. The specified pitch angle shown for each motor must not be exceeded.

□ Motor
Totally enclosed motor protected to IP 55. Maintenance-free and interference-free. Humidity protection of tropicalized windings. Deviation for ex-models.

□ Motor protection
All models (except pole switching and explosion proof) have thermal contacts or PTC thermistors and according to footnotes in the table to protect

through the following full motor protection units:
¹MW/MD, Ref. no. 1579/5849
²MSA, Ref. no. 1289 (for PTC thermistor temp. sens)
³M4, Ref. no. 1571
 All other models have to be protected by a conventional circuit breaker on site.

□ Guard
Hot-dipped or powder-coated as standard for HQ and AVD DK according to DIN EN ISO 13857.

□ Electrical connection
Terminal box protected to IP 54 mounted on motor. Outside of piping for HRF. Deviation for ex-models.

□ Speed control
Partial through voltage reduction, see the "transformer controller" column. Regulated performance curve upon request. Possible allocations of frequency inverters for all types (except pole-switch and ex-proof). The planned use of a frequency inverter without Sine filter must be stated when ordering. This requires a change of fan design and potential additional costs.

□ Reversed operation
All models are reversible when wired to a reversing switch. For reverse air flow direction allow a loss in performance of approx. 1/3.

□ Installation
Installation in any position. Ensure that the motor drainage holes face downwards.

□ Dimensions
Pole-switch and explosion proof models may deviate from the adjacent information. Motor build lengths vary. Note dimension B projection.

□ Sound levels
The sound power levels are specified through the frequency and as sum levels above the characteristic curves. Deviation for ex-models.

R.P.M.	Air flow volume (FID)	Motor power (nominal)*	Voltage	Power con. nom. volt./ (control)*	max. pitch angle	Wiring diagram	max. air flow temp.	Weight net*)	Model				Dim. B motor projection	Transformer controller for 5 speed pole switch		
									HQ incl. guard	Ref. no.	AVD DK incl. guard	Ref. no.		HRFD, AVD RK	Ref. no.	Model
min ⁻¹	V m ³ /h	kW	V	A	°	No.	+°C	kg					mm			
1 Phase motor, 230 Volt / 50 Hz, capacitor motor, protection to IP 55																
910	14200	0.60	230	2.6	25	965	40	40.0	HQW 710/6 ¹⁾	5047	—	—	—	—	MWS 5 ⁴⁾	1949
3 Phase motor, 400 Volt / 50 Hz, squirrel cage motor protection to IP 55																
690	13330	0.29	400	0.9	20	469	40	57.0	HQD 710/8 ¹⁾	5599	AVD DK 710/8 ¹⁾	5251	HRFD 710/8 ¹⁾	6930	RDS 2 ⁴⁾	1315
940	15560/19170	1.1*	230/400	5.1*	35	499	40	60.0	HQD 710/6 ¹⁾	5603	AVD DK 710/6 ¹⁾	5255	HRFD 710/6 ¹⁾	6934	RDS 7 ⁴⁾	1578
1445	26420	3.00*	400/690	6.2*	30	776	40	88.0	HQD 710/4 ²⁾	5606	AVD DK 710/4 ²⁾	5258	HRFD 710/4 ²⁾	6937	—	—
Two-speed, 3 ph., 400 V, 50 Hz, protection to IP 55																
730/890	13550/16090	0.4/0.75*	400/400	1.1/2.3*	25	520	40	55.0	HQD 710/6/6 ³⁾	5602	AVD DK 710/6/6 ³⁾	5254	HRFD 710/6/6 ³⁾	6933	RDS 4 ⁴⁾	1316
1120/1360	16140/19670	0.95/1.55*	400/400	2.4/4.2*	20	520	40	60.0	HQD 710/4/4 ³⁾	5604	AVD DK 710/4/4 ³⁾	5256	HRFD 710/4/4 ³⁾	6935	RDS 7 ⁴⁾	1578
1030/1340	19370/23280	1.5/2.2*	400/400	3.0/5.2*	26	520	40	75.0	HQD 710/4/4 ³⁾	5605	AVD DK 710/4/4 ³⁾	5257	HRFD 710/4/4 ³⁾	6936	RDS 7 ⁴⁾	1578
2 speed motor, pole-switching, Dahlander windings, 400 Volt, 50 Hz, protection to IP 54																
685/1430	10810/22090	0.5/2.0*	400/400	2.0/4.7	23	471	40	82.0	HQD 710/8/4/..	5611	AVD DK 710/8/4/..	5263	HRFD 710/8/4/..	6942	PDA 12 ⁵⁾	5081
720/1440	14155/29020	0.9/3.6*	400/400	2.9/8.3	30	471	40	108.0	HQD 710/8/4/..	5612	AVD DK 710/8/4/..	5264	AVD RK 710/8/4/..	6943	PDA 12 ⁵⁾	5081
Explosion proof Ex e II, 3 ph., 400 Volt, 50 Hz, protection to IP 55, temp. class T1-T3																
700	10450	0.55*	400	2.2*	35	470	40	68.0	HQD 710/8 Ex	5618	AVD DK 710/8 Ex	5270	HRFD 710/8 Ex	6948	125	not permitted
930	13480	0.55*	400	1.8*	25	470	40	67.0	HQD 710/6 Ex	5620	AVD DK 710/6 Ex	5272	HRFD 710/6 Ex	6949	95	not permitted
930	16770	0.95*	400	2.7*	35	470	40	77.0	HQD 710/6 Ex	5621	AVD DK 710/6 Ex	5273	HRFD 710/6 Ex	6950	135	not permitted
1420	20540	2.00*	400	4.7*	25	470	40	82.0	HQD 710/4 Ex	5623	AVD DK 710/4 Ex	5275	AVD RK 710/4 Ex	6951	180	not permitted
1420	26160	3.60*	400/690	8.1*	35	498	40	102.0	HQD 710/4 Ex	5624	AVD DK 710/4 Ex	5276	AVD RK 710/4 Ex	6952	200	not permitted

* Nominal motor amounts, Ex see info p. 16. 1) to 3) full motor protection unit, see "Motor protection" desc. ** Weights apply for type ..DK and ..RK, HRF and HQ less approx. 15 kg. 4) Incl. full motor protection.

710/4 R.P.M. = 1450

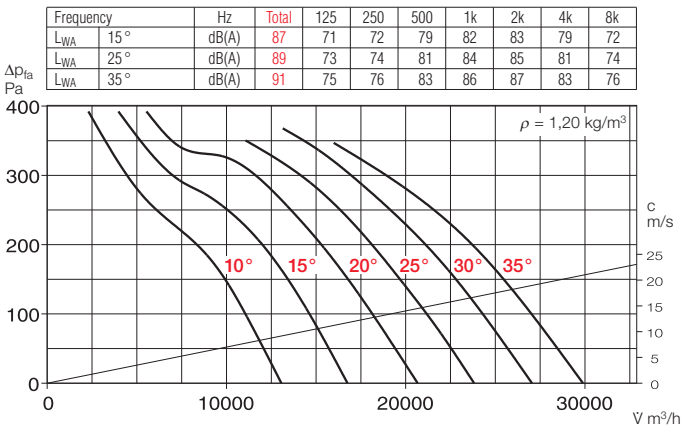

710/6 Three-phase R.P.M. = 950

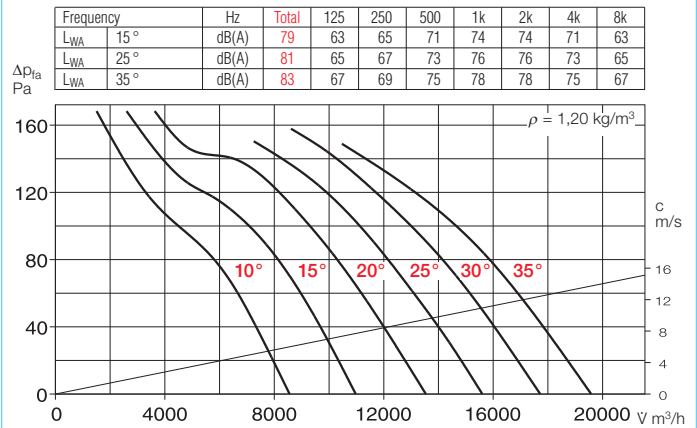

710/6 Single phase

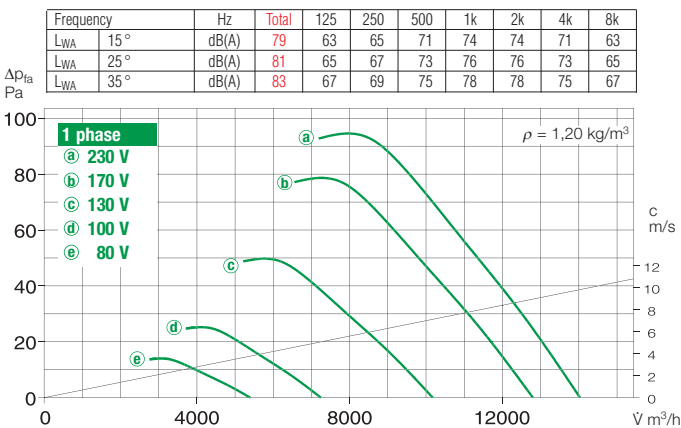

710/8 R.P.M. = 700

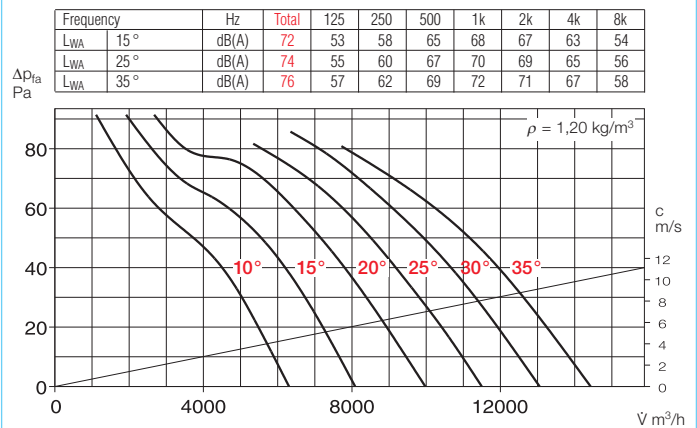

Electronic controller, stepless Frequency inverter with Sine filter		Vibration dampers nominal size	
Model	Ref. no.	SDD /SDZ Model	Ref. no.
—	—	..1/.1	1452/1454
ESD 5 ⁴⁾	0501	..1/.1	1452/1454
ESD 11,5 ⁴⁾	0502	..1/.1	1452/1454
FU-BS 8,0 ⁴⁾	5461	..2/.2	1453/1455
ESD 5 ⁴⁾	0501	..1/.1	1452/1454
ESD 5 ⁴⁾	0501	..1/.1	1452/1454
ESD 11,5 ⁴⁾	0502	..1/.2	1452/1455
—	—	..2/.2	1453/1455
—	—	..2/.2	1453/1455
not permitted	—	..1/.2	1452/1455
not permitted	—	..1/.2	1452/1455
not permitted	—	..1/.2	1452/1455
not permitted	—	..2/.2	1453/1455
not permitted	—	..2/.2	1453/1455

⁵⁾ see switch product page for flush mounted version.

Accessories for HRF / AVD RK Description see page 230 on

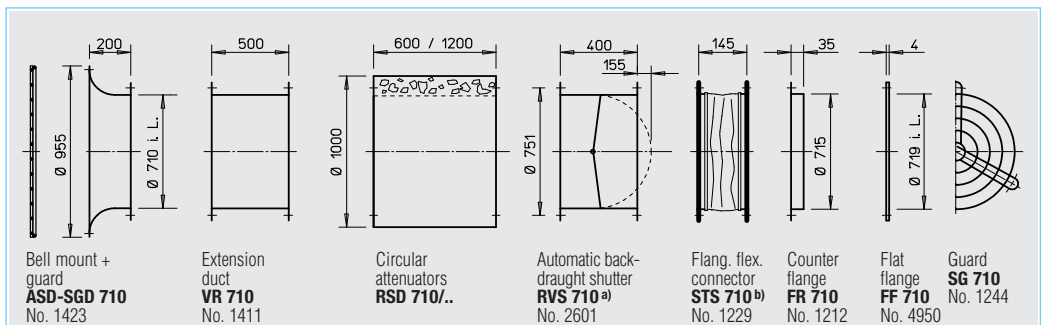

^{a)} For motorised shutters see accessory page

^{b)} Models for ex-proof fans see below

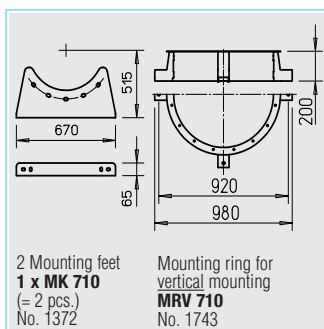

Information	Page	Other accessories	Page
Techn. description	140	^{b)} Accessories for explosion proof fans	Flanged flexible connector Type STS 710 Ex Ref. no. 2510
Selection chart	141		
Information for planning	10 on		
Made to order designs		Attenuators	434 on
Alternative voltages, protection classes, air flow direction, air flow temperature, acid protection and cast aluminium impellers are available on request.		Shutter and grilles	487 on
		Speed controllers and switches	525 on

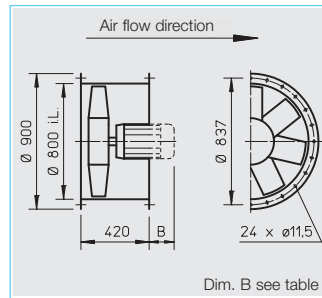
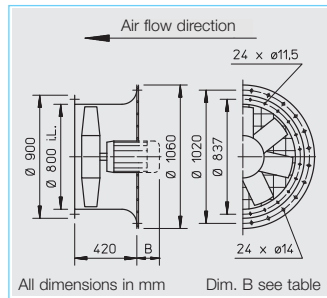

■ Specification for all models

□ Casing

With motor support manufactured from galvanised sheet steel.

□ Impeller

Highly efficient, profiled blade impeller, dynamically balanced and manufactured from impact resistant polymers. Suitable for -30 to +60 °C. Deviation for ex-models.

□ Pitch angle

The impeller blades are adjustable for the optimal coverage of the operating point (except explosion proof). The pitch angle is set at the factory (according to the order) and fixed. The motor allocation takes place using the maximum power pursuant to the information in the table below. The specified pitch angle shown for each motor must not be exceeded.

□ Motor

Totally enclosed motor protected to IP 55. Maintenance-free and interference-free. Humidity protection of tropicalized windings. Deviation for ex-models.

□ Motor protection

All models (except pole switching and explosion proof) have thermal contacts or PTC thermistors and according to footnotes in the table to protect through the following full motor protection units:
⁴⁾MSA, Ref. no. 1289 (for PTC thermistor temp. sens)
⁵⁾M4, Ref. no. 1571
 All other models have to be protected by a conventional circuit breaker on site.

□ Electrical connection

Terminal box protected to IP 54 mounted on motor.

□ Guard

According to DIN EN ISO 13857, hot-dip galvanised, as standard for AVD DK.

□ Speed control

Partial through voltage reduction, see the "transformer controller" column. Regulated performance curve upon request. Possible allocations of frequency inverters for all types (except pole-switch and ex-proof). The planned use of a frequency inverter without Sine filter must be stated when ordering. This requires a change of fan design and potential additional costs.

□ Reversed operation

All models are reversible when wired to a reversing switch. For reverse air flow direction allow a loss in performance of approx. 1/3.

□ Installation

Installation in any position. Ensure that the motor drainage holes face downwards.

□ Dimensions

Pole-switch and explosion proof models may deviate from the adjacent information. Motor build lengths vary. Note dimension B projection.

□ Sound levels

The sound power levels are specified through the frequency and as sum levels above the characteristic curves. Deviation for ex-models.

R.P.M.	Air flow volume (FID)	Motor power (nominal)*	Voltage	Power con. nom. volt.*	max. pitch angle	Wiring diagram	max. air flow temp.	Weight net	Model				Dim. B motor projection	Transformer controller for 5 speed pole switch	
									AVD DK incl. guard	Ref. no.	AVD RK	Ref. no.		Model	Ref. no.
min ⁻¹	V m ³ /h	kW	V	A	°	No.	+°C	kg					mm		
Three phase, 50 Hz, squirrel-cage motor, protection to IP 54															
1445	33450	4.00*	400/690	8.3*	26	776	40	101	AVD DK 800/4/.. ⁴⁾	5311	AVD RK 800/4/.. ⁴⁾	6960	210	—	—
1450	39130	5.5*	400/690	11*	33	776	40	115	AVD DK 800/4/.. ⁴⁾	5312	AVD RK 800/4/.. ⁴⁾	6961	290	—	—
Two-speed, 3 ph., 400 V, 50 Hz, protection to IP 55															
775/920	15720/18670	0.40/0.75*	400/400	1.1/2.3*	22	520	40	70	AVD DK 800/6/6/.. ⁵⁾	5307	AVD RK 800/6/6/.. ⁵⁾	6956	125	RDS 4 ²⁾	1316
Pole-switchable, 2-speed, 3 ph., 50 Hz, protection to IP 54															
695/1400	10020/20180	0.37/1.50*	400/400	1.3/3.7*	25	471	40	95	AVD DK 800/8/4/.. ¹⁾	5319	AVD RK 800/8/4/.. ¹⁾	6968	135	PDA 12 ³⁾	5081
Explosion proof Ex e II, 3 ph., 50 Hz, protection to IP 55, temp. class T1-T3															
700	17190	0.55*	400	2.2*	32	470	40	81	AVD DK 800/8 Ex/..	5326	AVD RK 800/8 Ex/..	6974	135	not permitted	
930	20340	0.95*	400	2.7*	23	470	40	90	AVD DK 800/6 Ex/..	5329	AVD RK 800/6 Ex/..	6976	135	not permitted	
950	26710	1.9*	400	4.7*	35	470	40	118	AVD DK 800/6 Ex/..	5330	AVD RK 800/6 Ex/..	6977	210	not permitted	
1420	31900	3.60*	400/690	8.1*	24	498	40	115	AVD DK 800/4 Ex/..	5332	AVD RK 800/4 Ex/..	6978	210	not permitted	
1450	36820	5.00*	400/690	10.1*	30	498	40	143	AVD DK 800/4 Ex/..	5333	AVD RK 800/4 Ex/..	6979	290	not permitted	

^{*)} Nominal motor amounts, Ex see info p. 16.

¹⁾ Dahlander winding.

²⁾ Incl full motor protection.

³⁾ see switch product page for flush mounted version.

800/4 R.P.M. = 1450

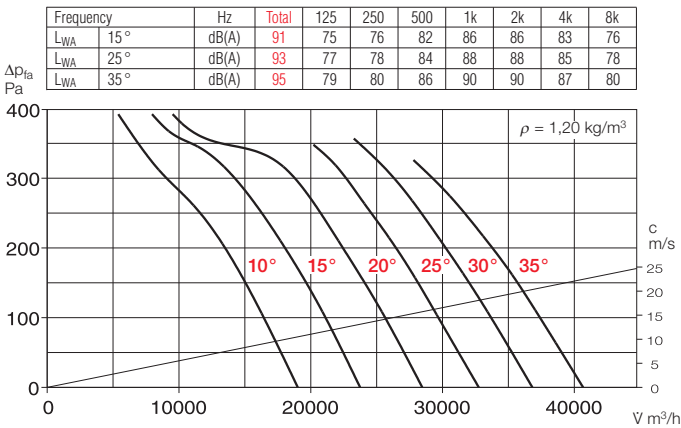

800/6 R.P.M. = 945

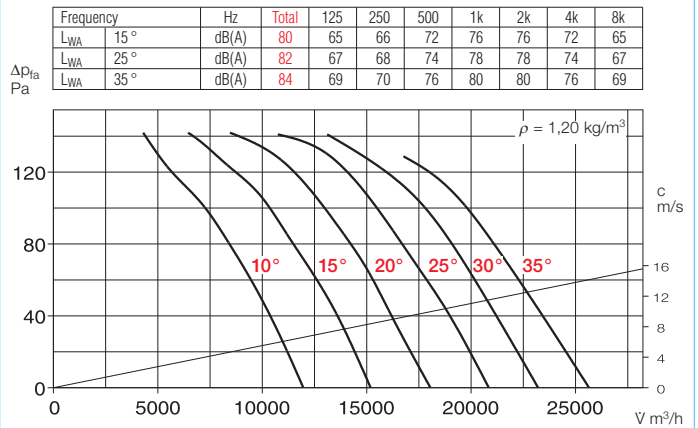

800/8 R.P.M. = 705

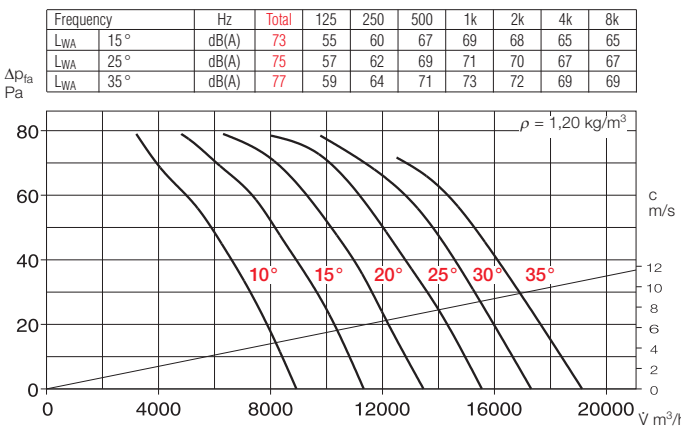

Accessories for AVD RK Description see page 230 on

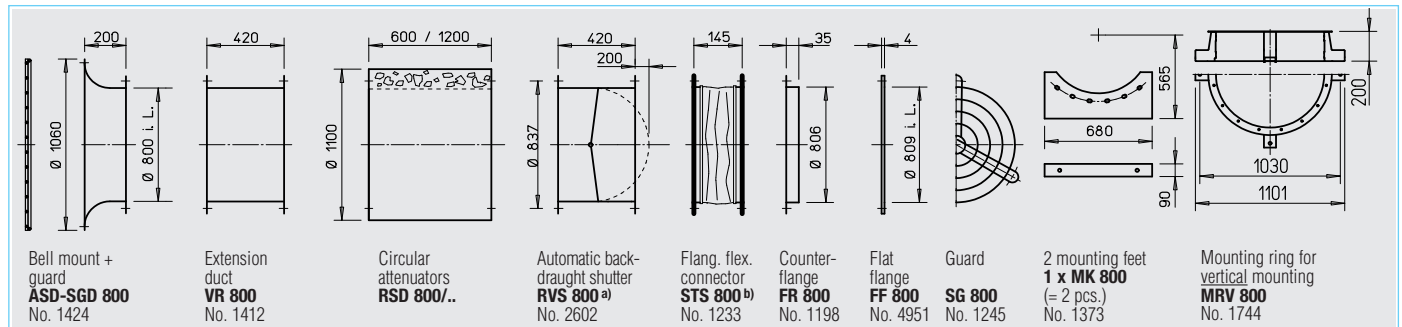

^{a)} For motorised shutters see accessory page

^{b)} Models for ex-proof fans see below

Electronic controller, stepless Frequency inverter with Sine filter		Vibration dampers nominal size	
Model	Ref. no.	Model	Ref. no.
FU-BS 10²⁾	5462	..2/..2	1453/1455
FU-BS 14²⁾	5463		
ESD 5²⁾	0501	..2/..2	1453/1455
—	—	..2/..2	1453/1455
not permitted		..2/..2	1453/1455
not permitted		..2/..2	1453/1455
not permitted		..2/..2	1453/1455
not permitted		..2/..2	1453/1455
not permitted		..2/..2	1453/1455

⁴⁾ and ⁵⁾ full motor protection, see description "Motor protection".

Information	Page	Other accessories	Page
Techn. description	140	Accessories for explosion proof fans	
Selection chart	141		
Information for planning	10 on		
Made to order designs		Flanged flexible connector	
Alternative voltages, protection classes, air flow direction, air flow temperature, acid protection and cast aluminium impellers are available on request.		Type STS 800 Ex Ref. no. 2511	
Note the technical information on page 15 on.		Attenuators	434 on
		Shutter and grilles	487 on
		Speed controllers and switches	525 on



■ Specification for all models

□ Casing

With motor support manufactured from galvanised sheet steel.

□ Impeller

Highly efficient, profiled blade impeller, dynamically balanced and manufactured from impact resistant polymers. Suitable for -30 to +60 °C. Deviation for ex-models.

□ Pitch angle

The impeller blades are adjustable for the optimal coverage of the operating point (except explosion proof). The pitch angle is set at the factory (according to the order) and fixed. The motor allocation takes place using the maximum power pursuant to the information in the table below. The specified pitch angle shown for each motor must not be exceeded.

□ Motor

Totally enclosed motor protected to IP 55. Maintenance-free and interference-free. Humidity protection of tropicalized windings. Deviation for ex-models.

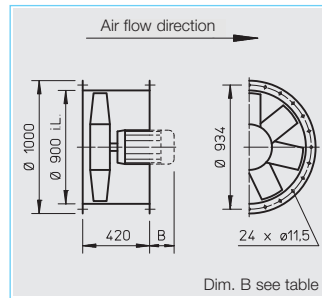
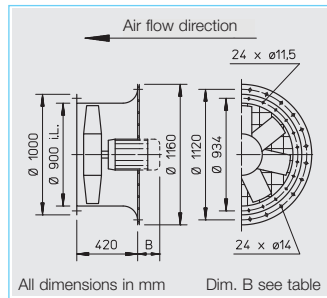

□ Motor protection

All models (except pole switching and explosion proof) have thermal contacts or PTC thermistors and according to footnotes in the table to protect through the following full motor protection units:
⁴MSA, Ref. no. 1289 (for PTC thermistor temp. sens)
⁵M4, Ref. no. 1571
 All other models have to be protected by a conventional circuit breaker on site.

□ Electrical connection

Terminal box protected to IP 54 mounted on motor.

□ Guard

According to DIN EN ISO 13857, hot-dip galvanised, as standard for AVD DK.

□ Speed control

Partial through voltage reduction, see the "transformer controller" column. Regulated performance curve upon request. Possible allocations of frequency inverters for all types (except pole-switch and ex-proof). The planned use of a frequency inverter without Sine filter must be stated when ordering. This requires a change of fan design and potential additional costs.

□ Reversed operation

All models are reversible when wired to a reversing switch. For reverse air flow direction allow a loss in performance of approx. 1/3.

□ Installation

Installation in any position. Ensure that the motor drainage holes face downwards.

□ Dimensions

Pole-switch and explosion proof models may deviate from the adjacent information. Motor build lengths vary. Note dimension B projection.

□ Sound levels

The sound power levels are specified through the frequency and as sum levels above the characteristic curves. Deviation for ex-models.

R.P.M.	Air flow volume (FID)	Motor power (nominal)*	Voltage	Power con. nom. volt.*	max. pitch angle	Wiring diagram	max. air flow temp.	Weight net	Model				Dim. B motor projection	Transformer controller for 5 speed pole switch	
									AVD DK incl. guard	Ref. no.	AVD RK	Ref. no.		Model	Ref. no.
min ⁻¹	V m ³ /h	kW	V	A	°	No.	+°C	kg				mm			
Three phase, 50 Hz, squirrel-cage motor, protection to IP 54															
950	37300	3.00*	400/690	6.2*	34	776	40	130	AVD DK 900/6/.. ⁴⁾	5369	AVD RK 900/6/.. ⁴⁾	6985	290	—	—
1445	35030	4.00*	400/690	8.3*	16	776	40	118	AVD DK 900/4/.. ⁴⁾	5370	AVD RK 900/4/.. ⁴⁾	6986	210	—	—
1450	48995	7.50*	400/690	14.5*	27	776	40	142	AVD DK 900/4/.. ⁴⁾	5371	AVD RK 900/4/.. ⁴⁾	6987	325	—	—
1470	57720	11.00*	400/690	20.0*	34	776	40	186	AVD DK 900/4/.. ⁴⁾	5372	AVD RK 900/4/.. ⁴⁾	6988	385	—	—
Two-speed, 3 ph., 400 V, 50 Hz, Y/Δ switch, protection to IP 55															
755/930	18390/22660	0.71/1.32*	400/400	2.1/4.0*	19	520	40	90	AVD DK 900/6/6/.. ⁵⁾	5367	AVD RK 900/6/6/.. ⁵⁾	6983	180	RDS 7 ²⁾	1578
770/920	25990/31060	1.38/2.37*	400/400	3.9/7.1*	27	520	40	115	AVD DK 900/6/6/.. ⁵⁾	5368	AVD RK 900/6/6/.. ⁵⁾	6984	210	RDS 11 ²⁾	1332
Pole-switchable, 2-speed, 3 ph., 50 Hz, protection to IP 54															
700/1435	18270/37450	1.10/4.50*	400/400	2.9/9.6*	18	471	40	120	AVD DK 900/8/4/.. ¹⁾	5379	AVD RK 900/8/4/.. ¹⁾	6995	290	PDA 12 ³⁾	5081
715/1450	22390/45410	1.80/6.50*	400/400	5.7/14.5*	24	471	40	148	AVD DK 900/8/4/.. ¹⁾	5380	AVD RK 900/8/4/.. ¹⁾	6996	325	PDA 25 ³⁾	5060
Explosion proof Ex e II, 3 ph., 50 Hz, protection to IP 55, temp. class T1-T3															
700	24470	0.95*	400	2.8*	27	470	40	110	AVD DK 900/8 Ex/..	5386	AVD RK 900/8 Ex/..	6899	180	not permitted	
725	28470	1.3*	400	3.9*	34	470	40	130	AVD DK 900/8 Ex/..	5387	AVD RK 900/8 Ex/..	6900	210	not permitted	
950	30550	1.90*	400	4.7*	25	470	40	135	AVD DK 900/6 Ex/..	5389	AVD RK 900/6 Ex/..	6901	210	not permitted	
960	38040	3.50*	400/690	7.4*	35	498	40	160	AVD DK 900/6 Ex/..	5390	AVD RK 900/6 Ex/..	6902	290	not permitted	
1450	46630	6.80*	400/690	13.6*	25	498	40	175	AVD DK 900/4 Ex/..	5392	AVD RK 900/4 Ex/..	6903	325	not permitted	
1465	55240	10.00*	400/690	19.8*	32	498	40	235	AVD DK 900/4 Ex/..	5393	AVD RK 900/4 Ex/..	6904	385	not permitted	

^{*)} Nominal motor amounts, Ex see info p. 16.

¹⁾ Dahlander winding.

²⁾ Incl full motor protection.

³⁾ see switch product page for flush mounted version.

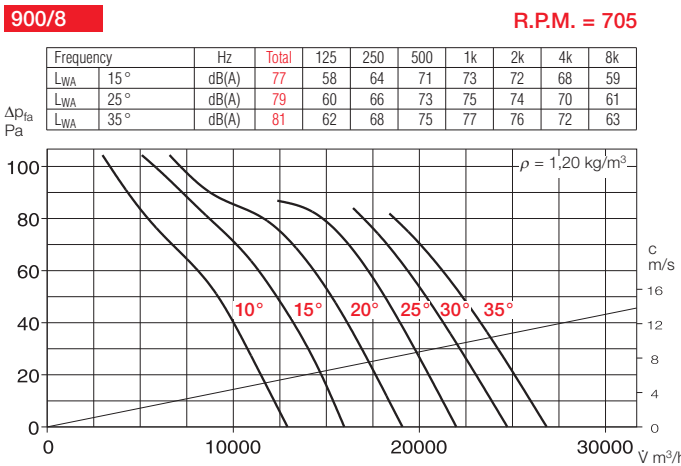
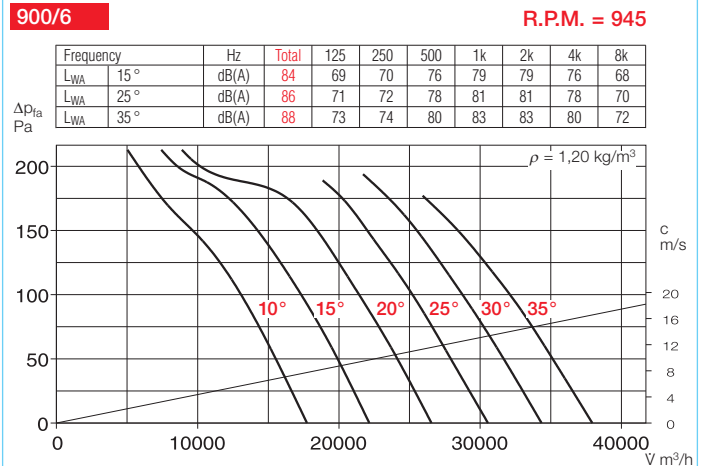
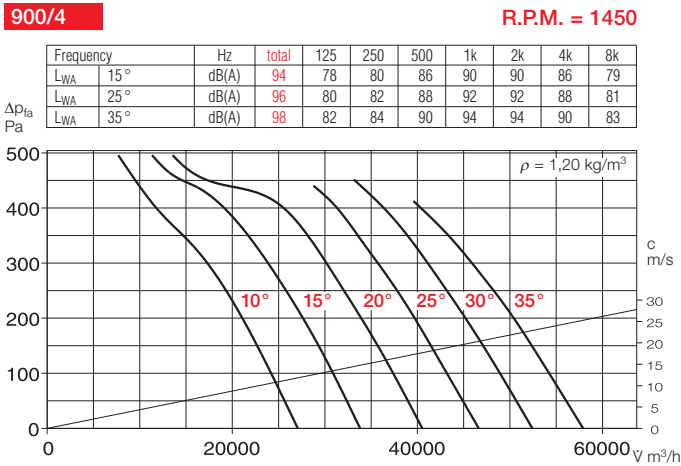

Accessories for AVD RK Description see page 230 on

Electronic controller, stepless Frequency inverter with Sine filter		Vibration dampers nominal size	
Model	Ref. no.	SDD /SDZ Model	Ref. no.
FU-BS 8,0 ²⁾	5461	..2/.2	1453/1455
FU-BS 10 ²⁾	5462	..3/.3	1367/1366
FU-CS 18 ²⁾	5469	..3/.3	1367/1366
FU-CS 22 ²⁾	5470	..3/.3	1367/1366
ESD 5 ²⁾	0501	..2/.2	1453/1455
ESD 11 ²⁾	0502	..2/.2	1453/1455
—	—	..2/.2	1453/1455
—	—	..2/.2	1453/1455
not permitted	..2/.2	1453/1455	
not permitted	..2/.2	1453/1455	
not permitted	..2/.2	1453/1455	
not permitted	..2/.2	1453/1455	
not permitted	..3/.3	1367/1366	
not permitted	..3/.3	1367/1366	

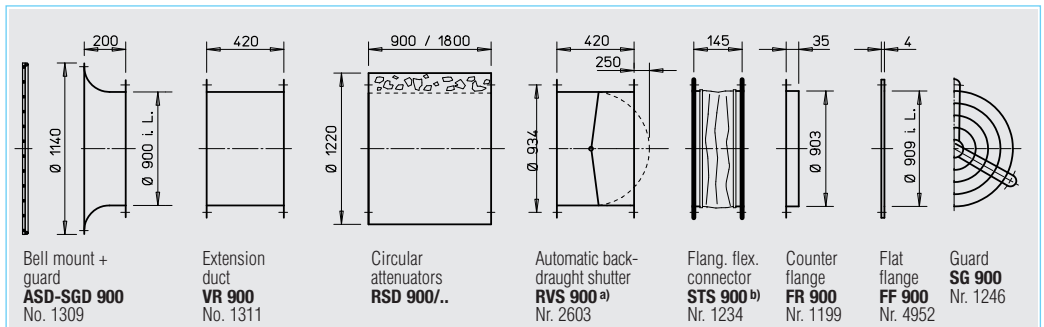

^{a)} For motorised shutters see accessory page

^{b)} Models for ex-proof fans see below

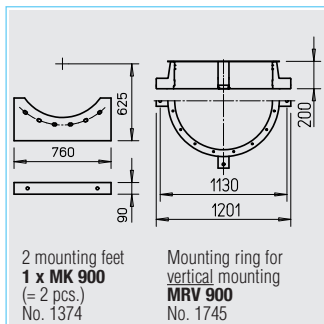

Information	Page	Other accessories	Page
Techn. description	140	^{b)} Accessories for explosion proof fans	
Selection chart	141	Flanged flexible connector Type STS 900 Ex Ref. no. 2512	
Information for planning	10 on	Attenuators	434 on
Made to order designs		Shutter and grilles	487 on
Alternative voltages, protection classes, air flow direction, air flow temperature, acid protection and cast aluminium impellers are available on request.		Speed controllers and switches	525 on

⁴⁾ and ⁵⁾ full motor protection, see description "Motor protection".

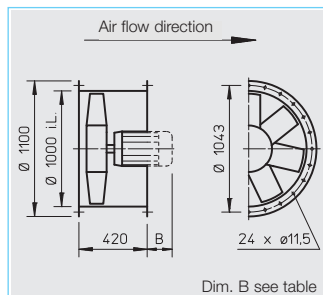
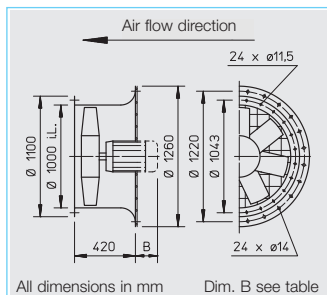

■ Specification for all models

□ Casing

With motor support manufactured from galvanised sheet steel.

□ Impeller

Highly efficient, profiled blade impeller, dynamically balanced and manufactured from impact resistant polymers. Suitable for -30 to +60 °C. Deviation for ex-models.

□ Pitch angle

The impeller blades are adjustable for the optimal coverage of the operating point (except explosion proof). The pitch angle is set at the factory (according to the order) and fixed. The motor allocation takes place using the maximum power pursuant to the information in the table below. The specified pitch angle shown for each motor must not be exceeded.

□ Motor

Totally enclosed motor protected to IP 55. Maintenance-free and interference-free. Humidity protection of tropicalized windings. Deviation for ex-models.

□ Motor protection

All models (except pole switching and explosion proof) have thermal contacts or PTC thermistors and according to footnotes in the table to protect through the following full motor protection units:

⁴⁾MSA, Ref. no. 1289 (for PTC thermistor temp. sens)

⁵⁾M4, Ref. no. 1571

All other models have to be protected by a conventional circuit breaker on site.

□ Electrical connection

Terminal box protected to IP 54 mounted on motor.

□ Guard

According to DIN EN ISO 13857, hot-dip galvanised, as standard for AVD DK.

□ Speed control

Partial through voltage reduction, see the “transformer controller” column. Regulated performance curve upon request. Possible allocations of frequency inverters for all types (except pole-switch and ex-proof). The planned use of a frequency inverter without Sine filter must be stated when ordering. This requires a change of fan design and potential additional costs.

□ Reversed operation

All models are reversible when wired to a reversing switch. For reverse air flow direction allow a loss in performance of approx. 1/3.

□ Installation

Installation in any position. Ensure that the motor drainage holes face downwards.

□ Dimensions

Pole-switch and explosion proof models may deviate from the adjacent information. Motor build lengths vary. Note dimension B projection.

□ Sound levels

The sound power levels are specified through the frequency and as sum levels above the characteristic curves. Deviation for ex-models.

R.P.M.	Air flow volume (FID)	Motor power (nominal)*	Voltage	Power con. nom. volt.*	max. pitch angle	Wiring diagram	max. air flow temp.	Weight net	Model				Dim. B motor projection	Transformer controller for 5 speed pole switch		
									AVD DK incl. guard	Ref. no.	AVD RK	Ref. no.		Model	Ref. no.	
min ⁻¹	V m ³ /h	kW	V	A	°	No.	+°C	kg					mm			
Three phase, 50 Hz, squirrel-cage motor, protection to IP 54																
950	39720	3.0*	400/690	6.2*	23	776	40	120	AVD DK 1000/6/.. ⁴⁾	5398	AVD RK 1000/6/.. ⁴⁾	5573	290	—	—	
955	46320	4.0*	400/690	9.2*	29	776	40	127	AVD DK 1000/6/.. ⁴⁾	5399	AVD RK 1000/6/.. ⁴⁾	5574	325	—	—	
955	52450	5.5*	400/690	12.4*	35	776	40	145	AVD DK 1000/6/.. ⁴⁾	5400	AVD RK 1000/6/.. ⁴⁾	5575	325	—	—	
1470	61460	11.0*	400/690	20.0*	23	776	40	160	AVD DK 1000/4/.. ⁴⁾	5401	AVD RK 1000/4/.. ⁴⁾	5576	385	—	—	
1470	71290	15.0*	400/690	26.0*	29	776	40	195	AVD DK 1000/4/.. ⁴⁾	5402	AVD RK 1000/4/.. ⁴⁾	5577	430	—	—	
1475	79440	18.5*	400/690	35.0*	34	776	40	210	AVD DK 1000/4/.. ⁴⁾	5403	AVD RK 1000/4/.. ⁴⁾	5578	465	—	—	
Pole-switchable, 2-speed, 3 ph., 50 Hz, protection to IP 54																
715/1440	27410/55210	2.2/9.0*	400/400	7.2/19.0*	20	471	40	165	AVD DK 1000/8/4/.. ¹⁾	5407	AVD RK 1000/8/4/.. ¹⁾	5582	385	PDA 25 ³⁾	5060	
715/1445	32325/65330	3.0/12.0*	400/400	9.4/25.0*	26	471	40	190	AVD DK 1000/8/4/.. ¹⁾	5408	AVD RK 1000/8/4/.. ¹⁾	5583	415	PDA 63 ³⁾	1283	
Explosion proof Ex e II, 3 ph., 50 Hz, protection to IP 55, temp. class T1-T3																
955	43180	3.5*	400/690	7.4*	26	498	40	130	AVD DK 1000/6 Ex/..	5415	AVD RK 1000/6 Ex/..	5590	325	not permitted		
960	52730	6.6*	400/690	13.4*	35	498	40	155	AVD DK 1000/6 Ex/..	5416	AVD RK 1000/6 Ex/..	5591	400	not permitted		
1480	70160	15.0*	400/690	27.5*	28	498	40	200	AVD DK 1000/4 Ex/..	5417	AVD RK 1000/4 Ex/..	5592	430	not permitted		
1470	77600	17.5*	400/690	33.0*	33	498	40	225	AVD DK 1000/4 Ex/..	5418	AVD RK 1000/4 Ex/..	5593	470	not permitted		

^{*)} Nominal motor amounts, Ex see info p. 16.

¹⁾ Dahlander winding.

²⁾ Incl full motor protection.

³⁾ see switch product page for flush mounted version.

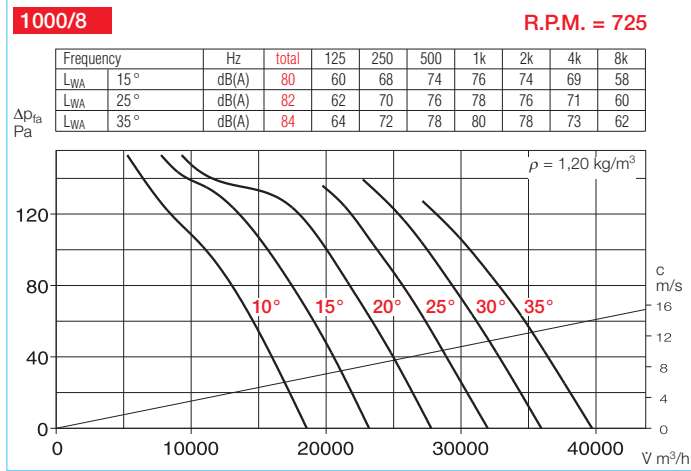
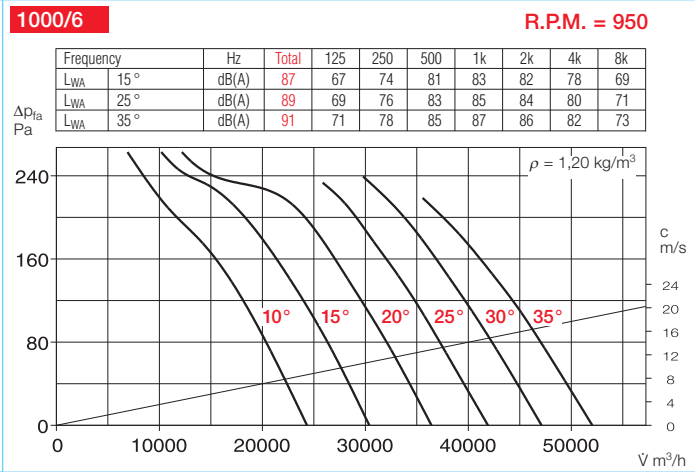
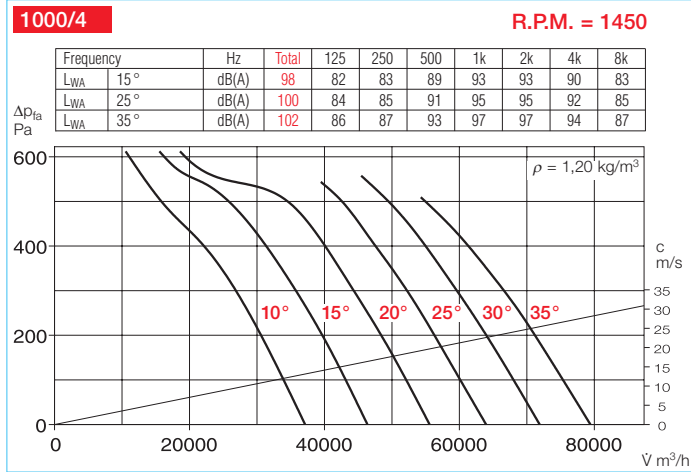

Accessories for AVD RK Description see page 230 on

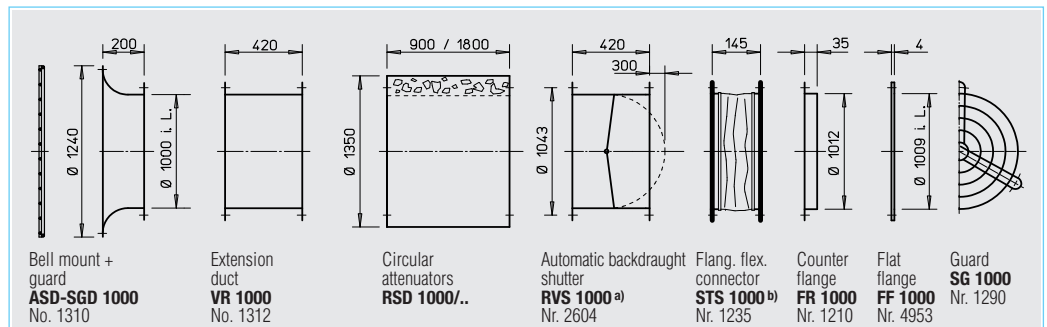

a) For motorised shutters see accessory page

b) Models for ex-proof fans see below

Electronic controller, stepless Frequency inverter with Sine filter		Vibration dampers nominal size	
Model	Ref. no.	Model	Ref. no.
FU-BS 8,0 ²⁾	5461	..2/.2	1453/1455
FU-BS 10,0 ²⁾	5462	..2/.2	1453/1455
FU-BS 10,0 ²⁾	5462	..2/.2	1453/1455
FU-CS 22 ²⁾	5470	..3/.3	1367/1366
FU-CS 32 ²⁾	5471	..3/.3	1367/1366
FU-CS 40 ²⁾	5472	..3/.3	1367/1366
—	—	..3/.3	1367/1366
—	—	..3/.3	1367/1366
not permitted	..2/.2	1453/1455	
not permitted	..2/.2	1453/1455	
not permitted	..3/.3	1367/1366	
not permitted	..3/.3	1367/1366	

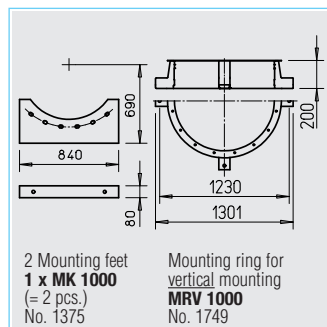

Information	Page	Other accessories	Page
Techn. description	140	b) Accessories for explosion proof fans	
Selection chart	141		
Information for planning	10 on		
Made to order designs		Flanged flexible connector Type STS 1000 Ex Ref. no. 2513	
Alternative voltages, protection classes, air flow direction, air flow temperature, acid protection and cast aluminium impellers are available on request.		Attenuators	434 on
		Shutter and grilles	487 on
		Speed controllers and switches	525 on

4) and 5) full motor protection, see description "Motor protection".

Medium-pressure axial fans.
High-performance for a variety of
areas of application.

INNOVATIVE

With capacities of up to 32 000 m³/h and very high pressures of up to 1400 Pa, the range of medium-pressure axial fans is ideally suited to the requirements of professional ventilation technology. Universal installation possibilities (horizontal and vertical positioning) allow for flexible use in a number of areas of application.



THE NEW AMD / AMW: Innovative axial impeller and a new type of guide wheel.

The well-known and tried-and-tested range with adjustable vanes was enhanced by the AMD / AMW with diameters from 225 to 400 mm with motors with controllable voltages in three-phase and direct current and a fixed pitch angle.

The new, optimally tailored system, consisting of a polymer impeller with perfectly integrated inflow geometry, a new type of guide wheel with maximal pressure recovery and specially coordinated motors ensure an optimal degree of efficiency.

In the AMD/AMW, a product was created that fulfills the maximum physical demands.

ENERGY-EFFICIENT

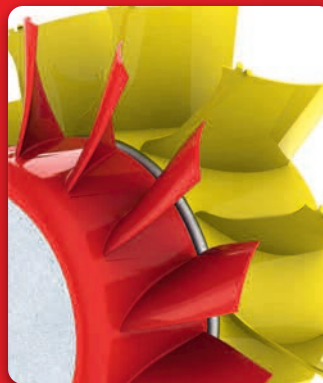

This has enormous benefits:

- High pressures and volumes with the smallest of dimensions.
- Minimal noise.
- Minimal energy costs with maximum performance.
- Maximum pressure recovery thanks to the new guide wheel.
- Very little residual spin.
- Low impact and outlet losses.

UNIVERSAL



The entire AMD range with over 300 types in 12 sizes (NG 315–1120) and volume > 113 000 m³/h is included in a separate catalogue.

Includes B AMD types for machine-based smoke extraction systems (MRA) in temperature classes F300 and F400 as well as assembly kits for two-level series Z or parallel P designs.



Axial and
VAR fans

This information supplements the "General technical information".

■ Features

The new AMD/AMWs are a range of medium-pressure fans with a compact design and excellent power density in relation to their size. The new axial impeller with optimised pressure and efficiency achieves an optimal degree of efficiency, high pressure and large volume conveyed in conjunction with the fixed guide wheel.

■ Casing

Duct casing on both sides with flanges in accordance with DIN 24155 page 3 with integrated guide wheel and motor mount made of galvanised steel. Terminal box on the outside of the duct.

■ Impeller

Polymer axial impeller with 14 spatially curved vanes and inflow geometry perfectly integrated into the impeller. Maximum pressure recovery in combination with the new guide wheel, a high degree of efficiency, low noise during operation, high corrosion-resistance, low-vibration operation thanks to dynamic balancing in accordance with DIN ISO 1940 T.1 – grade 6.3.

■ Air flow temperatures

The standard design can be used in the range of -30 to at least +40 °C. See the product page for information. An approval for higher long-term temperatures is possible upon request.

■ Airflow direction

The airflow direction cannot be changed, but it is defined by the method of installation. The correct motor rotation and airflow direction is marked with an arrow on the fan.

■ Installation position, mounting, condensation outlets

Given a length of 2.5 times the duct diameter and when placed in the middle of ducting, a corresponding straight section of ducting is required to achieve the stated performance values given unimpeded outflow of air (Figure 1). The ideal inflow of the fan is only guaranteed if a suction nozzle with sufficient free suction space or a straight line with the same diameter and length 2.5 times the diameter is placed upstream in the duct construction.

□ The installation position and fastening should be designed so that the fan is free from deformation and can be securely fastened. AMD/AMW can be installed and operated in any chosen location. When dealing with equipment with condensate drain holes, their location must be chosen carefully.

□ The fans must not be operated when in contact with water. When installed outdoors, effective weather protection must be ensured.

□ For operation under difficult conditions, such as high humidity, excessive strain due to climatic, technical and electronic influences, approval for use must be requested and received, as the default design may not be suitable under certain circumstances.

■ Positioning

The use of vibration dampers is recommended to prevent the transfer of vibrations (accessories SDD, SDZ). Motors with a large construction size can protrude at the back and cause an uneven distribution due to their high weight. An extension tube (VR, accessories) is to be provided to find the centre of gravity!

■ Installation examples

□ **Horizontal**

– **Fig. 2**
Free suction, pressure-side operation with an attenuator with an intermediate flange. To reduce the sound pressure on the suction or pressure side, corresponding ducting attenuator can be fitted with an intermediate flange.

– **Fig. 3**
Hanging from the ceiling
Figure 3 shows the typical installation for use as ventilation technology. The installation of AMD/AMW systems on ceilings is possible by way of direct suspension using mounting brackets (MK) and vibration dampers (accessories SDD, SDZ). The ducting casing with flanges on both sides (according to DIN 24155 page 3) is designed for direct installation in the ducting.

□ **Vertical**

– **Fig. 4**
Integrated in the ducting with attenuator on the intake-side. Mounting on the wall with brackets or through the ceiling. The elements are to be hung separately according to the

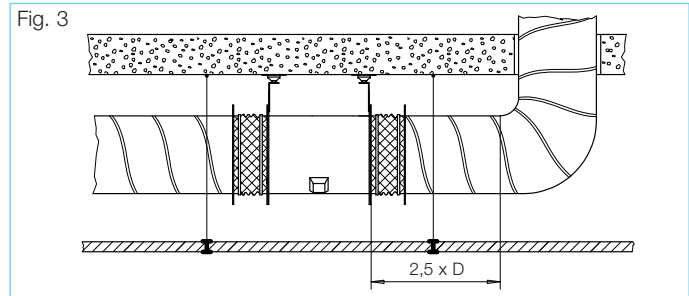
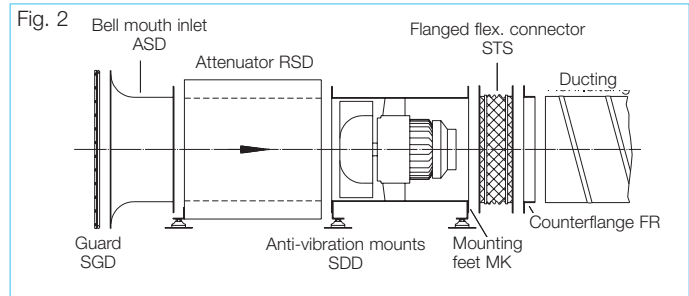
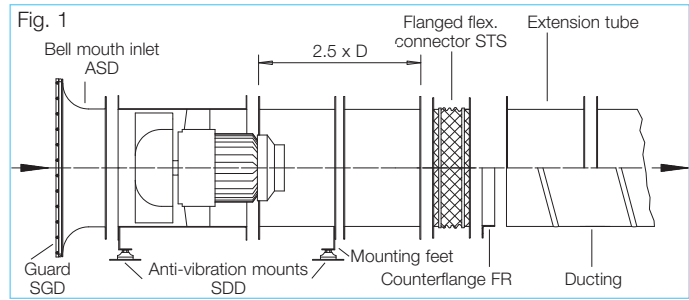

weight. Do not install the fan with load balancing when making changes. From a construction size of 315, mounting rings MRV are available for fitting the fan vertically. The weight of the fan including the attached accessories must not exceed the load bearing capacity of the MRV.

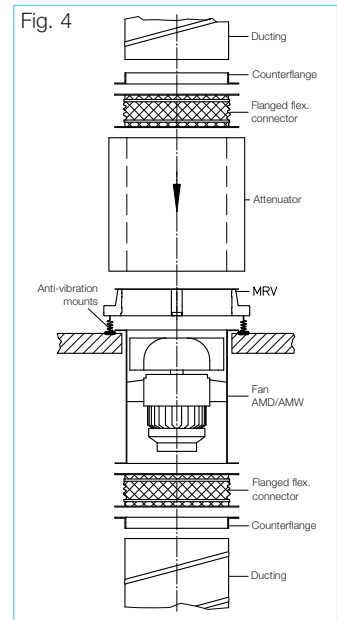

Information	Page
Information for project planning, Acoustics	10 on
General techn. information, speed control	15 on

By combining the parameters of static pressure increase Δp_{fa} , air flow volume \dot{V} , speed min^{-1} , sound pressure level dB(A) and impeller diameter DN mm, the following table facilitates the selection of AMD/AMW high-pressure fans.

Diameter mm	R.P.M. min^{-1}	Sound pressure Intake L_{pA} dB(A) at 4 m	Air flow volume \dot{V} m^3/h in relation to static pressure = N / m^2 = freely available pressure (Δp_{fa}) in Pa												
			0	25	50	75	100	150	200	300	400	500	600	700	800
225	2800	53	1950	1900	1860	1780	1720	1590	1400						
	1400	38	950	840	710										
250	2800	56	2620	2550	2480	2410	2340	2180	1980						
	1400	42	1360	1250	1080										
280	2800	59	3970	3910	3850	3760	3690	3540	3360	3020					
	1400	44	1930	1810	1650	1450									
315	2800	63	5440	5360	5300	5240	5160	4970	4810	4450	4020				
	1400	48	2870	2730	2590	2390	2210								
355	2800	68	8610	8540	8470	8390	8310	8140	7970	7600	7180	6760	6260	5490	
	1400	52	4170	4040	3860	3660	3470	3070							
400	2800	73	12420	12330	12250	12160	12060	11870	11700	11310	10870	10420	9890	9260	8450
	1400	56	6000	5810	5600	5400	5200	4740	3940						

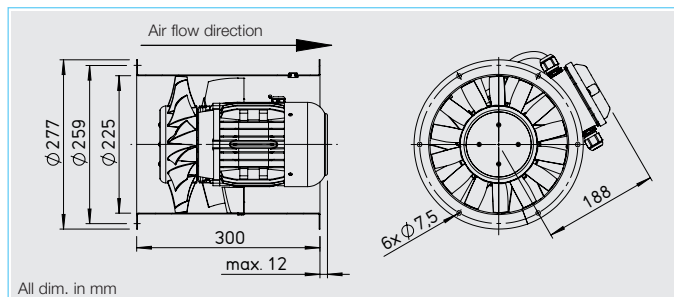

■ Specification

□ Casing

Manufactured in galvanised sheet steel with flanges on both sides to DIN 24155, Pt. 3. with fixed guide vanes and motor support.

□ Impeller / guide vanes

Impeller with 3D profiled blades and integrated inflow geometry made from high quality polymers. Connected to an optimised guide vane made from galvanised steel. Impeller and guide vane efficiency and pressure optimised for high volume flows by means of CFD. Dynamically balanced according to DIN ISO 1940-1. Operating range -30 to +40 °C.

□ Motor

Direct driven, maintenance free flange motor, totally enclosed with an aluminium casing and cooling fins, protected to IP 54. Sealed for life ball bearings and interference-free. Optional drainage holes made to order (please state installation position). Optional tropicalized protection of windings with humidity protection waterproofing.

□ Speed control

The voltage-controllable models the current are marked by a value in the “regular power consumption” column of the table below which must be used when selecting a controller (see controller column). The air flow volumes can be seen from the characteristic curves. If the fan is to be controlled by a frequency inverter without a sine filter, this must be stated when ordering. This requires a change of fan design and potential additional costs.

□ Electrical connection

Terminal box fitted externally on the casing as standard (IP 55).

□ Installation

Installation in any position. Ensure that motor drainage holes (where used) face downwards.

□ Motor protection

All models have thermal contacts as standard which must be connected to a full motor protection unit (see table below) for effective motor protection.

□ Sound levels

Data shown within the performance curves refers to sound power and pressure levels in 4 m free field conditions, for medium operating point intake/exhaust. Sound emission and acoustic information on page 10 on.

Information	Page
Selection chart	183
Information for planning	10 on
Made to order designs	
Alternative voltages, frequencies, protection classes, acid protection, high temperatures etc. are available on request.	

Other accessories	Page
Installation accessories	230 on
Attenuators	436 on
Switch and control technology	525 on

Type	Ref. no.	R.P.M.	Air flow volume (FID)	Motor power	Voltage	Current		Wiring diagram	Maximum air flow temp.		Weight (net) approx.	5 step transformer controller		Frequency inverter with integrated sine filter	
		min ⁻¹				V m ³ /h	kW		V	standard supply		speed controlled	No.	+°C	+°C
1 phase motor, 50 Hz, protection to IP 54															
AMW 225/4	2242	1425	965	0.6	230	0.3	0.3	966.1	60	40	8.7	MWS 1,5 ¹⁾	1947	—	—
AMW 225/2	2243	2750	1955	0.26	230	1.2	1.4	966.1	60	40	9	MWS 1,5 ¹⁾	1947	—	—
3 phase motor, 50 Hz, protection to IP 54															
AMD 225/4	2244	1430	960	0.6	400	0.2	0.25	469	60	40	8.3	RDS 1 ¹⁾	1314	—	—
AMD 225/2	2245	2760	1950	0.25	400	0.6	0.65	469	60	40	8.8	RDS 1 ¹⁾	1314	—	—

¹⁾ includes full motor protection device

225/2

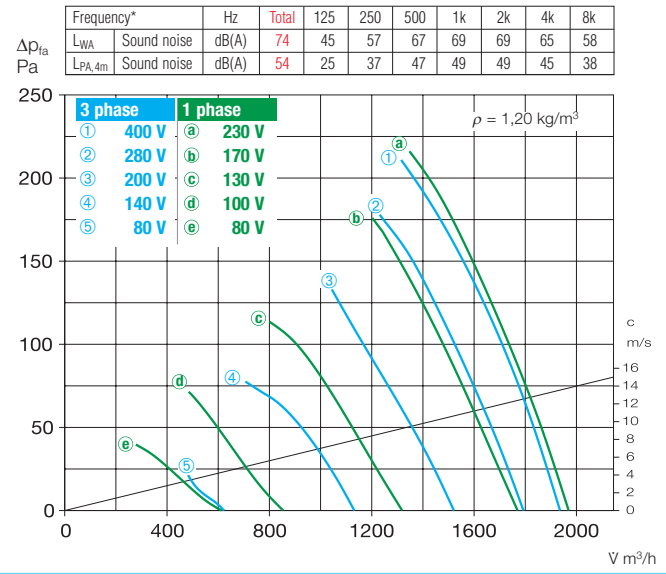

* 3 phase motor sound information. 1 phase motor sound information see www.HeliosSelect.de

225/4

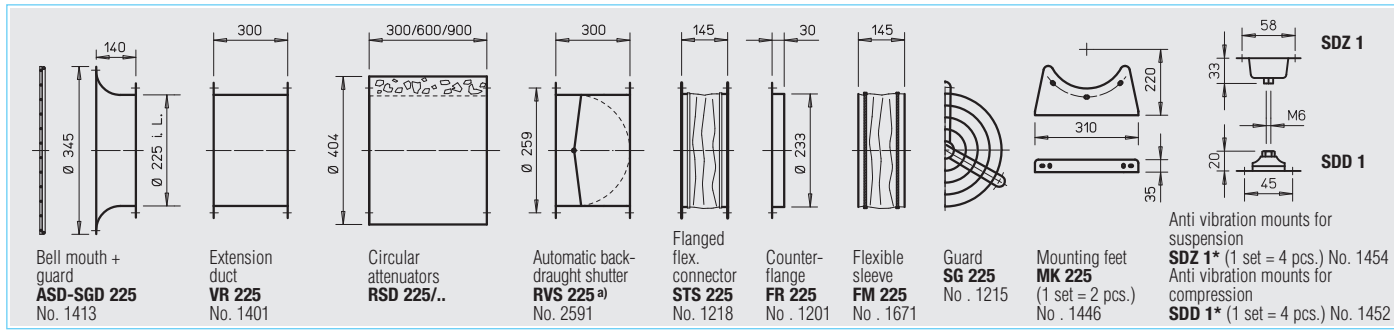
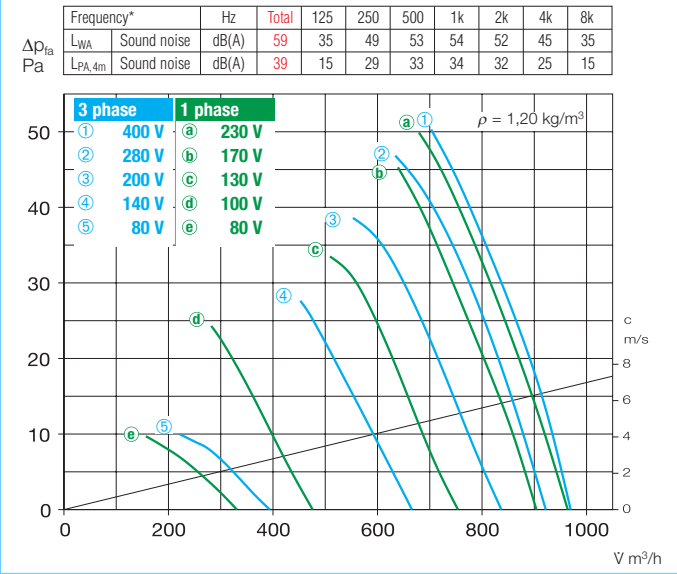

a) For motorised shutters see accessory pages

* Type allocation see table, last column

Full motor protection device for connection of thermal contacts		Vibration dampers			
		Compression		Suspension	
		Type	Ref. no.	Type	Ref. no.
MW	1579	SDD 1	1452	SDZ 1	1454
MW	1579	SDD 1	1452	SDZ 1	1454
MD	5849	SDD 1	1452	SDZ 1	1454
MD	5849	SDD 1	1452	SDZ 1	1454

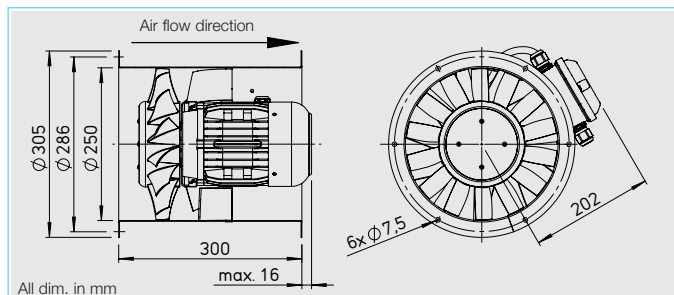

■ Specification

□ Casing

Manufactured in galvanised sheet steel with flanges on both sides to DIN 24155, Pt. 3. with fixed guide vanes and motor support.

□ Impeller / guide vanes

Impeller with 3D profiled blades and integrated inflow geometry made from high quality polymers. Connected to an optimised guide vane made from galvanised steel. Impeller and guide vane efficiency and pressure optimised for high volume flows by means of CFD. Dynamically balanced according to DIN ISO 1940-1. Operating range -30 to +40 °C.

□ Motor

Direct driven, maintenance free flange motor, totally enclosed with an aluminium casing and cooling fins, protected to IP 54. Sealed for life ball bearings and interference-free. Optional drainage holes made to order (please state installation position). Optional tropicalized protection of windings with humidity protection waterproofing.

□ Speed control

The voltage-controllable models the current are marked by a value in the “regular power consumption” column of the table below which must be used when selecting a controller (see controller column). The air flow volumes can be seen from the characteristic curves. If the fan is to be controlled by a frequency inverter without a sine filter, this must be stated when ordering. This requires a change of fan design and potential additional costs.

□ Electrical connection

Terminal box fitted externally on the casing as standard (IP 55).

□ Installation

Installation in any position. Ensure that motor drainage holes (where used) face downwards.

□ Motor protection

All models have thermal contacts as standard which must be connected to a full motor protection unit (see table below) for effective motor protection.

□ Sound levels

Data shown within the performance curves refers to sound power and pressure levels in 4 m free field conditions, for medium operating point intake/exhaust. Sound emission and acoustic information on page 10 on.

■ Information Page

Selection chart	183
Information for planning	10 on

Made to order designs

Alternative voltages, frequencies, protection classes, acid protection, high temperatures etc. are available on request.

■ Other accessories Page

Installation accessories	230 on
Attenuators	436 on
Switch and control technology	525 on

Type	Ref. no.	R.P.M.	Air flow volume (FID)	Motor power	Voltage	Current		Wiring diagram	Maximum air flow temp.		Weight (net) approx.	5 step transformer controller		Frequency inverter with integrated sine filter	
		min ⁻¹				V m ³ /h	kW		V	standard supply		speed controlled	No.	standard supply	speed controlled
1 phase motor, 50 Hz, protection to IP 54															
AMW 250/4	2248	1435	1360	0.1	230	0.6	0.6	966.1	60	40	9	MWS 1,5 ¹⁾	1947	—	—
AMW 250/2	2249	2630	2620	0.4	230	1.9	1.9	966.1	60	40	9.5	MWS 3 ¹⁾	1948	—	—
3 phase motor, 50 Hz, protection to IP 54															
AMD 250/4	2250	1430	1380	0.08	400	0.3	0.3	469	60	40	9.2	RDS 1 ¹⁾	1314	—	—
AMD 250/2	2251	2830	2790	0.43	400	1	1	469	60	40	11	RDS 2 ¹⁾	1315	FU-BS 2,5	5459

¹⁾ includes full motor protection device

250/2

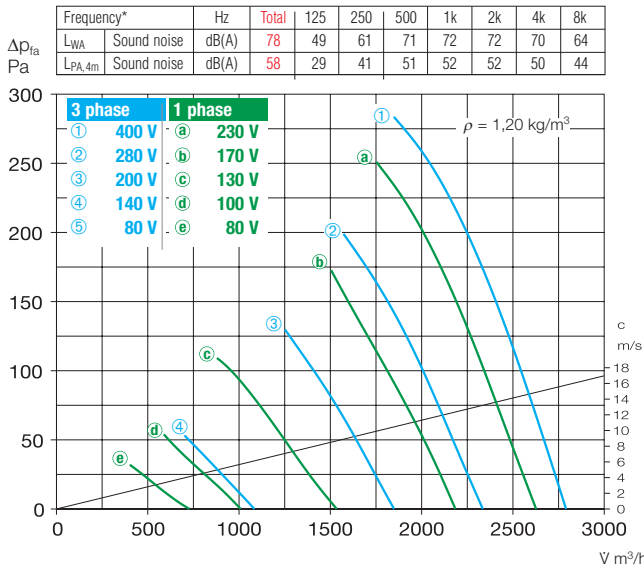

* 3 phase motor sound information. 1 phase motor sound information see www.HeliosSelect.de

250/4

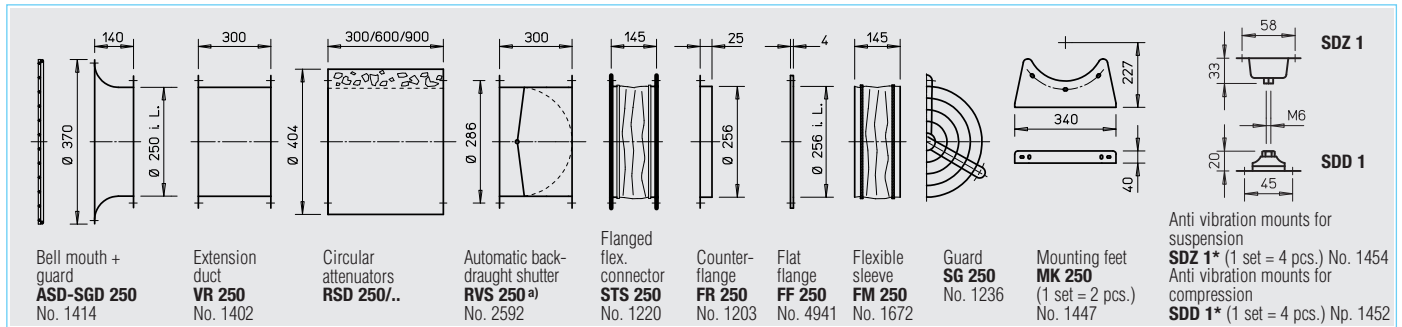
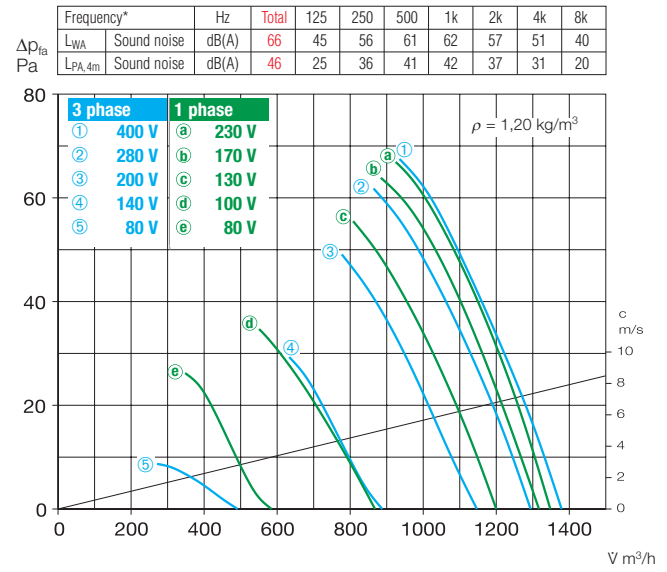

^{a)} For motorised shutters see accessory pages

* Type allocation see table, last column

	Full motor protection device for connection of thermal contacts	Vibration dampers				
		Compression		Suspension		
		Type	Ref. no.	Type	Ref. no.	
		SDD 1	1452	SDZ 1	1454	
	MW	1579	SDD 1	1452	SDZ 1	1454
	MD	5849	SDD 1	1452	SDZ 1	1454
	MD	5849	SDD 1	1452	SDZ 1	1454

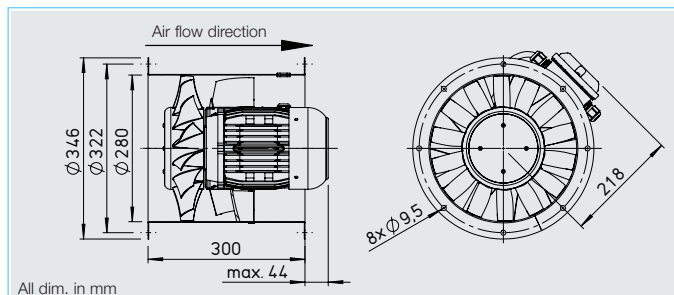

■ Specification

□ Casing

Manufactured in galvanised sheet steel with flanges on both sides to DIN 24155, Pt. 3. with fixed guide vanes and motor support.

□ Impeller / guide vanes

Impeller with 3D profiled blades and integrated inflow geometry made from high quality polymers. Connected to an optimised guide vane made from galvanised steel. Impeller and guide vane efficiency and pressure optimised for high volume flows by means of CFD. Dynamically balanced according to DIN ISO 1940-1. Operating range -30 to +40 °C.

□ Motor

Direct driven, maintenance free flange motor, totally enclosed with an aluminium casing and cooling fins, protected to IP 54. Sealed for life ball bearings and interference-free. Optional drainage holes made to order (please state installation position). Optional tropicalized protection of windings with humidity protection waterproofing.

□ Speed control

The voltage-controllable models the current are marked by a value in the “regular power consumption” column of the table below which must be used when selecting a controller (see controller column). The air flow volumes can be seen from the characteristic curves. If the fan is to be controlled by a frequency inverter without a sine filter, this must be stated when ordering. This requires a change of fan design and potential additional costs.

□ Electrical connection

Terminal box fitted externally on the casing as standard (IP 55).

□ Installation

Installation in any position. Ensure that motor drainage holes (where used) face downwards.

□ Motor protection

All models have thermal contacts as standard which must be connected to a full motor protection unit (see table below) for effective motor protection.

□ Sound levels

Data shown within the performance curves refers to sound power and pressure levels in 4 m free field conditions, for medium operating point intake/exhaust. Sound emission and acoustic information on page 10 on.

Information	Page
Selection chart	183
Information for planning	10 on
Made to order designs	
Alternative voltages, frequencies, protection classes, acid protection, high temperatures etc. are available on request.	

Other accessories	Page
Installation accessories	230 on
Attenuators	436 on
Switch and control technology	525 on

Type	Ref. no.	R.P.M.	Air flow volume (FID)	Motor power	Voltage	Current		Wiring diagram	Maximum air flow temp.		Weight (net) approx.	5 step transformer controller		Frequency inverter with integrated sine filter		
		min ⁻¹				V m ³ /h	kW		V	standard supply		speed controlled	A	A	No.	+°C
1 phase motor, 50 Hz, protection to IP 54																
AMW 280/4	2254	1345	1930	0.1	230	0.5	0.5	966.1	60	40	11.5	MWS 1,5 ¹⁾	1947	—	—	
AMW 280/2	2255	2755	3970	0.7	230	3.2	4.3	976.1	60	40	15.5	MWS 5 ¹⁾	1949	—	—	
3 phase motor, 50 Hz, protection to IP 54																
AMD 280/4	2256	1385	2000	0.1	400	0.3	0.3	469	60	40	10.5	RDS 1 ¹⁾	1314	—	—	
AMD 280/2	2257	2745	3960	0.7	400	1.4	1.5	469	60	40	13.8	RDS 2 ¹⁾	1315	FU-BS 2,5	5459	

¹⁾ includes full motor protection device

280/2

Frequency*		Hz	Total	125	250	500	1k	2k	4k	8k	
Δp_{fa}	L _{WA}	Sound noise	dB(A)	80	52	60	72	74	74	72	65
	L _{PA,4m}	Sound noise	dB(A)	60	32	40	52	54	54	52	45

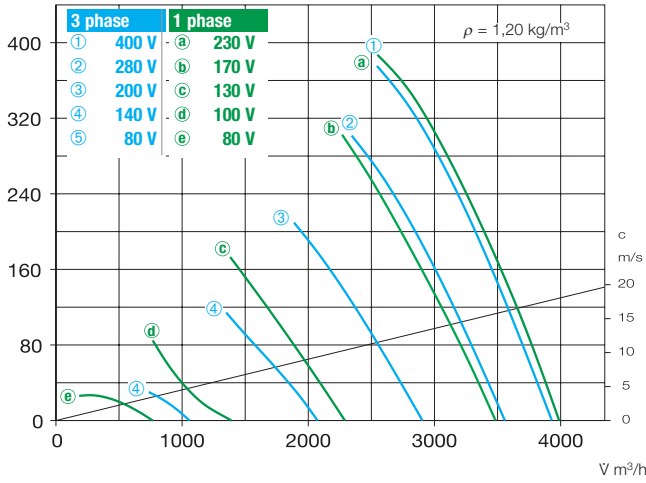

* 3 phase motor sound information. 1 phase motor sound information see www.HeliosSelect.de

280/4

Frequency*		Hz	Total	125	250	500	1k	2k	4k	8k	
Δp_{fa}	L _{WA}	Sound noise	dB(A)	64	36	52	57	59	58	54	45
	L _{PA,4m}	Sound noise	dB(A)	44	16	32	37	39	38	34	25

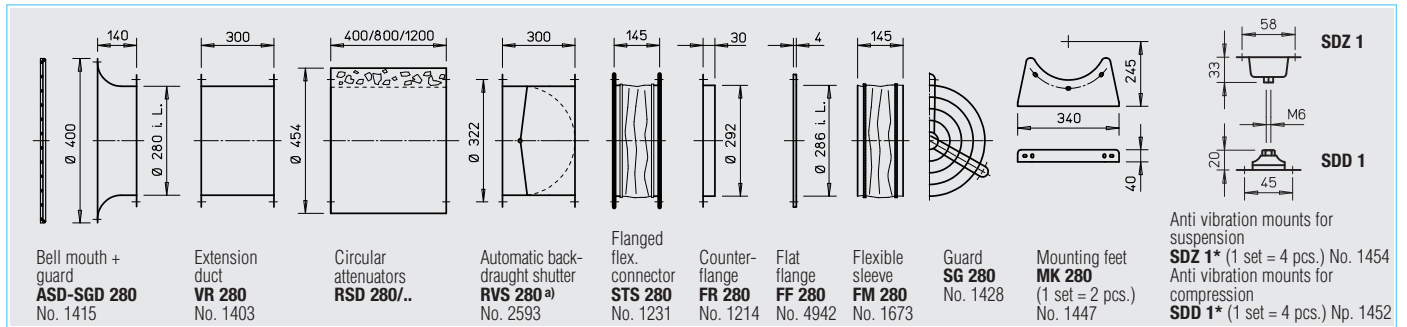
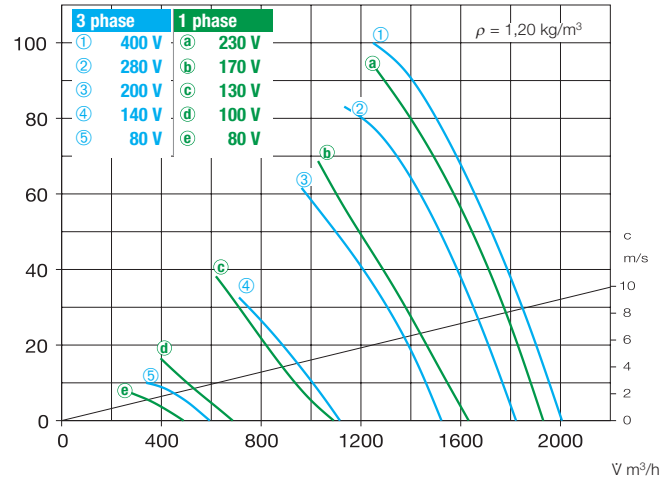

a) For motorised shutters see accessory pages

* Type allocation see table, last column

	Full motor protection device for connection of thermal contacts	Vibration dampers			
		Compression		Suspension	
		Type	Ref. no.	Type	Ref. no.
		SDD 1	1452	SDZ 1	1454
MW	1579	SDD 1	1452	SDZ 1	1454
MD	5849	SDD 1	1452	SDZ 1	1454
MD	5849	SDD 1	1452	SDZ 1	1454

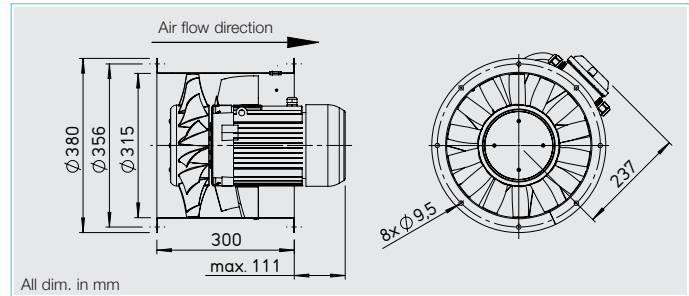

■ Specification

□ Casing

Manufactured in galvanised sheet steel with flanges on both sides to DIN 24155, Pt. 3. with fixed guide vanes and motor support.

□ Impeller / guide vanes

Impeller with 3D profiled blades and integrated inflow geometry made from high quality polymers. Connected to an optimised guide vane made from galvanised steel. Impeller and guide vane efficiency and pressure optimised for high volume flows by means of CFD. Dynamically balanced according to DIN ISO 1940-1. Operating range -30 to +40 °C.

□ Motor

Direct driven, maintenance free flange motor, totally enclosed with an aluminium casing and cooling fins, protected to IP 54. Sealed for life ball bearings and interference-free. Optional drainage holes made to order (please state installation position). Optional tropicalized protection of windings with humidity protection waterproofing.

□ Speed control

The voltage-controllable models the current are marked by a value in the “regular power consumption” column of the table below which must be used when selecting a controller (see controller column). The air flow volumes can be seen from the characteristic curves. If the fan is to be controlled by a frequency inverter without a sine filter, this must be stated when ordering. This requires a change of fan design and potential additional costs.

□ Electrical connection

Terminal box fitted externally on the casing as standard (IP 55).

□ Installation

Installation in any position. Ensure that motor drainage holes (where used) face downwards.

□ Motor protection

All models have thermal contacts as standard which must be connected to a full motor protection unit (see table below) for effective motor protection.

□ Sound levels

Data shown within the performance curves refers to sound power and pressure levels in 4 m free field conditions, for medium operating point intake/exhaust. Sound emission and acoustic information on page 10 on.

■ Information Page

Selection chart	183
Information for planning	10 on

Made to order designs

Alternative voltages, frequencies, protection classes, acid protection, high temperatures etc. are available on request.

■ Other accessories Page

Installation accessories	230 on
Attenuators	436 on
Switch and control technology	525 on

Type	Ref. no.	R.P.M.	Air flow volume (FID)	Motor power	Voltage	Current		Wiring diagram	Maximum air flow temp.		Weight (net) approx.	5 step transformer controller		Frequency inverter with integrated sine filter	
		min ⁻¹				V m ³ /h	standard supply		speed controlled	standard supply		speed controlled	Type	Ref. no.	Type
1 phase motor, 50 Hz, protection to IP 54															
AMW 315/4	2265	1395	2860	0.2	230	1	1.1	966.1	60	40	13.1	MWS 1,5 ¹⁾	1947	—	—
3 phase motor, 50 Hz, protection to IP 54															
AMD 315/4	2266	1455	2950	0.2	400	0.6	0.6	469	60	40	12.2	RDS 1 ¹⁾	1314	—	—
Two-speed, 3 phase motor, 50 Hz, Y/Δ wiring, protection to IP 54															
AMD 315/2/2	2267	2200/2650	7640/8610	0.7/1.1	400/400	1.6/2.5	2.3	520	60	40	18.5	RDS 4 ¹⁾	1316	FU-BS 5,0	5460

¹⁾ includes full motor protection device

315/2

Frequency*		Hz	Total	125	250	500	1k	2k	4k	8k
Δp_{fa}	L _{WA}	Sound noise	dB(A)	83	57	67	77	78	75	68
Pa	L _{PA,4m}	Sound noise	dB(A)	63	37	47	58	58	55	48

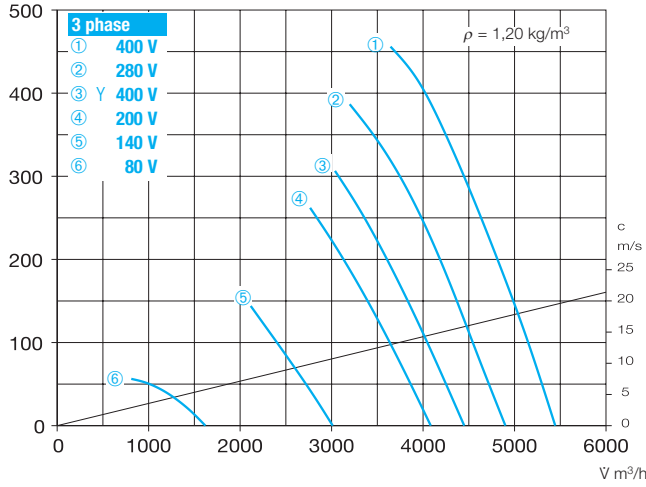

* 3 phase motor sound information. 1 phase motor sound information see www.HeliosSelect.de

315/4

Frequency*		Hz	Total	125	250	500	1k	2k	4k	8k
Δp_{fa}	L _{WA}	Sound noise	dB(A)	70	42	58	63	64	61	53
Pa	L _{PA,4m}	Sound noise	dB(A)	50	22	38	43	44	41	33

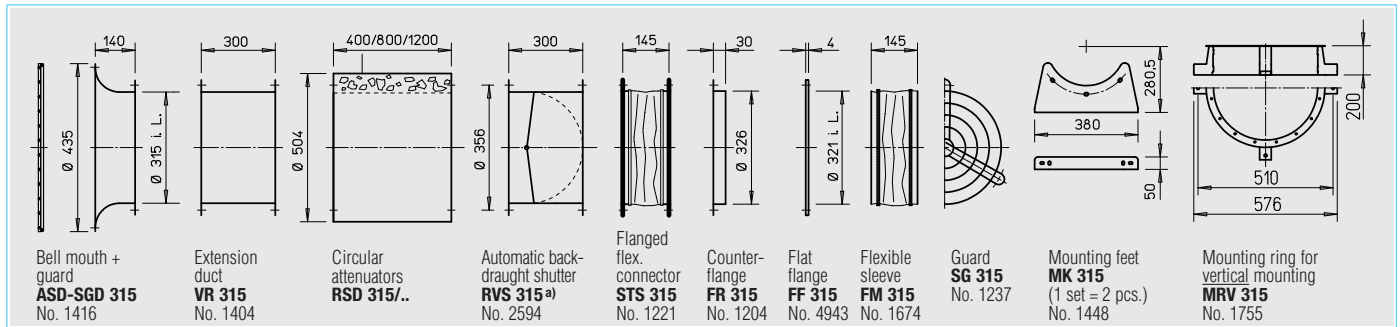
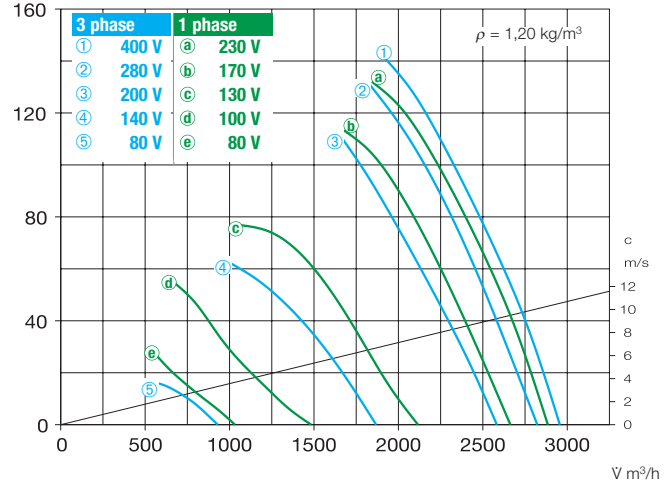

^{a)} For motorised shutters see accessory pages

* Type allocation see table, last column

	Full motor protection device for connection of thermal contacts	Vibration dampers			
		Compression		Suspension	
		Type	Ref. no.	Type	Ref. no.
	MW	1579	SDD 1 1452	SDZ 1	1454
	MD	5849	SDD 1 1452	SDZ 1	1454
	M 4	1571	SDD 1 1452	SDZ 1	1454

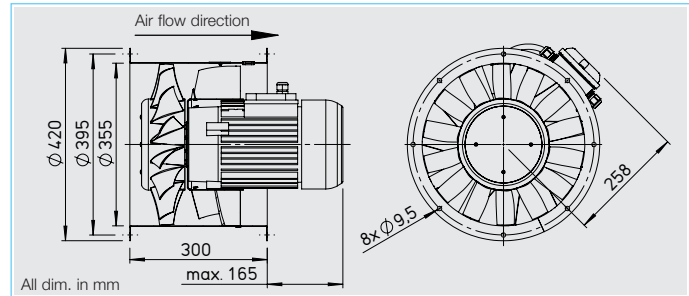

■ Specification

□ Casing

Manufactured in galvanised sheet steel with flanges on both sides to DIN 24155, Pt. 3. with fixed guide vanes and motor support.

□ Impeller / guide vanes

Impeller with 3D profiled blades and integrated inflow geometry made from high quality polymers. Connected to an optimised guide vane made from galvanised steel. Impeller and guide vane efficiency and pressure optimised for high volume flows by means of CFD. Dynamically balanced according to DIN ISO 1940-1. Operating range -30 to +40 °C.

□ Motor

Direct driven, maintenance free flange motor, totally enclosed with an aluminium casing and cooling fins, protected to IP 54. Sealed for life ball bearings and interference-free. Optional drainage holes made to order (please state installation position). Optional tropicalized protection of windings with humidity protection waterproofing.

□ Speed control

The voltage-controllable models the current are marked by a value in the “regular power consumption” column of the table below which must be used when selecting a controller (see controller column). The air flow volumes can be seen from the characteristic curves. If the fan is to be controlled by a frequency inverter without a sine filter, this must be stated when ordering. This requires a change of fan design and potential additional costs.

□ Electrical connection

Terminal box fitted externally on the casing as standard (IP 55).

□ Installation

Installation in any position. Ensure that motor drainage holes (where used) face downwards.

□ Motor protection

All models have thermal contacts as standard which must be connected to a full motor protection unit (see table below) for effective motor protection.

□ Sound levels

Data shown within the performance curves refers to sound power and pressure levels in 4 m free field conditions, for medium operating point intake/exhaust. Sound emission and acoustic information on page 10 on.

Information	Page
Selection chart	183
Information for planning	10 on
Made to order designs	
Alternative voltages, frequencies, protection classes, acid protection, high temperatures etc. are available on request.	

Other accessories	Page
Installation accessories	230 on
Attenuators	436 on
Switch and control technology	525 on

Type	Ref. no.	R.P.M.	Air flow volume (FID)	Motor power	Voltage	Current		Wiring diagram	Maximum air flow temp.		Weight (net) approx.	5 step transformer controller		Frequency inverter with integrated sine filter	
		min ⁻¹				V m ³ /h	kW		V	standard supply		speed controlled	No.	+°C	+°C
1 phase motor, 50 Hz, protection to IP 54															
AMW 355/4	2275	1430	4170	0.4	230	1.8	2.4	968.1	60	40	16.9	MWS 3 ¹⁾	1948	—	—
3 phase motor, 50 Hz, protection to IP 54															
AMD 355/4	2276	1445	4300	0.35	400	0.9	1.1	469	60	40	15.7	RDS 2 ¹⁾	1315	FU-BS 2,5	5459
Two-speed, 3 phase motor, 50 Hz, Y/Δ wiring, protection to IP 54															
AMD 355/2/2	2277	2200/2775	8610/7640	1.3 / 2.3	400/400	3.0/5.4	5.6	520	60	40	30.3	RDS 7 ¹⁾	1578	FU-BS 8,0	5461

¹⁾ includes full motor protection device

355/2

Frequency*		Hz	Total	125	250	500	1k	2k	4k	8k	
Δp_{fa}	L _{WA}	Sound noise	dB(A)	88	63	71	81	82	83	80	74
Pa	L _{PA,4m}	Sound noise	dB(A)	68	43	51	61	62	63	60	54

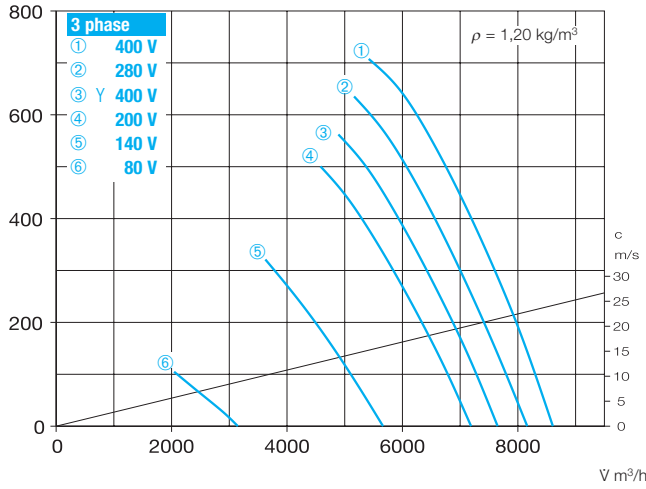

* 3 phase motor sound information. 1 phase motor sound information see www.HeliosSelect.de

355/4

Frequency*		Hz	Total	125	250	500	1k	2k	4k	8k	
Δp_{fa}	L _{WA}	Sound noise	dB(A)	73	48	61	66	67	66	65	56
Pa	L _{PA,4m}	Sound noise	dB(A)	53	28	41	46	47	46	45	36

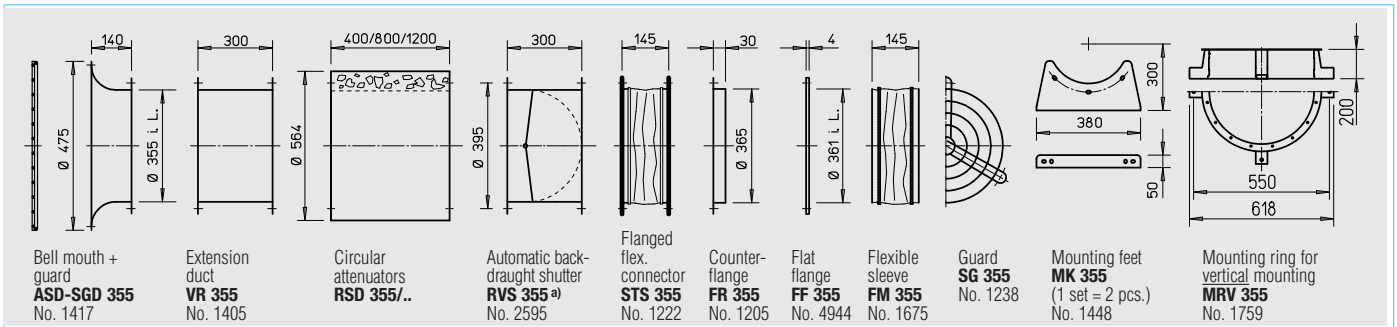
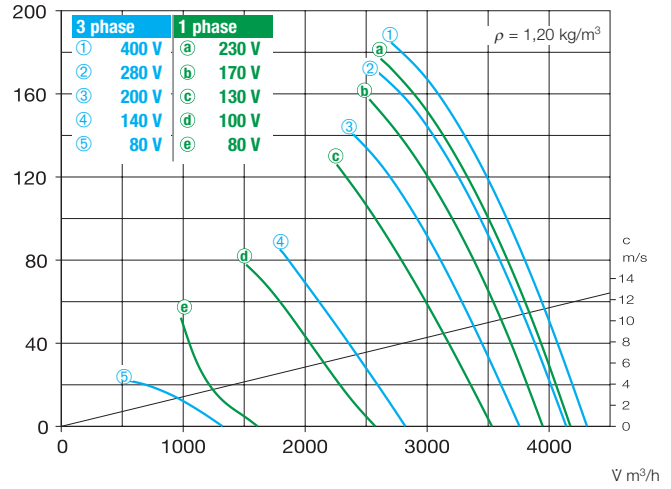

^{a)} For motorised shutters see accessory pages

* Type allocation see table, last column

	Full motor protection device for connection of thermal contacts	Vibration dampers			
		Compression		Suspension	
		Type	Ref. no.	Type	Ref. no.
	MW	1579	SDD 1 1452	SDZ 1 1454	
	MD	5849	SDD 1 1452	SDZ 1 1454	
	M 4	1571	SDD 1 1452	SDZ 1 1454	

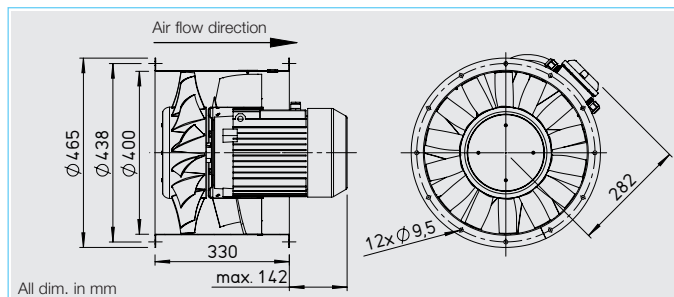

■ Specification

□ Casing

Manufactured in galvanised sheet steel with flanges on both sides to DIN 24155, Pt. 3. with fixed guide vanes and motor support.

□ Impeller / guide vanes

Impeller with 3D profiled blades and integrated inflow geometry made from high quality polymers. Connected to an optimised guide vane made from galvanised steel. Impeller and guide vane efficiency and pressure optimised for high volume flows by means of CFD. Dynamically balanced according to DIN ISO 1940-1. Operating range -30 to +40 °C.

□ Motor

Direct driven, maintenance free flange motor, totally enclosed with an aluminium casing and cooling fins, protected to IP 54. Sealed for life ball bearings and interference-free. Optional drainage holes made to order (please state installation position). Optional tropicalized protection of windings with humidity protection waterproofing.

□ Speed control

The voltage-controllable models the current are marked by a value in the “regular power consumption” column of the table below which must be used when selecting a controller (see controller column). The air flow volumes can be seen from the characteristic curves. If the fan is to be controlled by a frequency inverter without a sine filter, this must be stated when ordering. This requires a change of fan design and potential additional costs.

□ Electrical connection

Terminal box fitted externally on the casing as standard (IP 55).

□ Installation

Installation in any position. Ensure that motor drainage holes (where used) face downwards.

□ Motor protection

All models have thermal contacts as standard which must be connected to a full motor protection unit (see table below) for effective motor protection.

□ Sound levels

Data shown within the performance curves refers to sound power and pressure levels in 4 m free field conditions, for medium operating point intake/exhaust. Sound emission and acoustic information on page 10 on.

■ Information Page

Selection chart	183
Information for planning	10 on

Made to order designs

Alternative voltages, frequencies, protection classes, acid protection, high temperatures etc. are available on request.

■ Other accessories Page

Installation accessories	230 on
Attenuators	436 on
Switch and control technology	525 on

Type	Ref. no.	R.P.M.	Air flow volume (FID)	Motor power	Voltage	Current		Wiring diagram	Maximum air flow temp.		Weight (net) approx.	5 step transformer controller		Frequency inverter with integrated sine filter	
		min ⁻¹				V m ³ /h	standard supply		speed controlled	standard supply		speed controlled	Type	Ref. no.	Type
1 phase motor, 50 Hz, protection to IP 54															
AMW 400/4	2280	1395	6000	0.6	230	2.6	3.1	967.1	60	40	23.2	MWS 5 ¹⁾	1949	—	—
3 phase motor, 50 Hz, protection to IP 54															
AMD 400/4	2281	1420	5980	0.6	400	1.9	2	469	60	40	22	RDS 4 ¹⁾	1316	FU-BS 2,5	5459
Two-speed, 3 phase motor, 50 Hz, Y/Δ wiring, protection to IP 54															
AMD 400/2/2	2282	2280/2780	10880/12430	2.4/4.4	400/400	5.5/9.5	9.5	520	50	30	44.9	RDS 11 ¹⁾	1332	FU-BS 14	5463

¹⁾ includes full motor protection device

400/2

Frequency*		Hz	Total	125	250	500	1k	2k	4k	8k
Δp_{fa}	L _{WA}	Sound noise	dB(A)	93	65	74	88	88	83	75
Pa	L _{PA,4m}	Sound noise	dB(A)	73	45	54	68	68	63	55

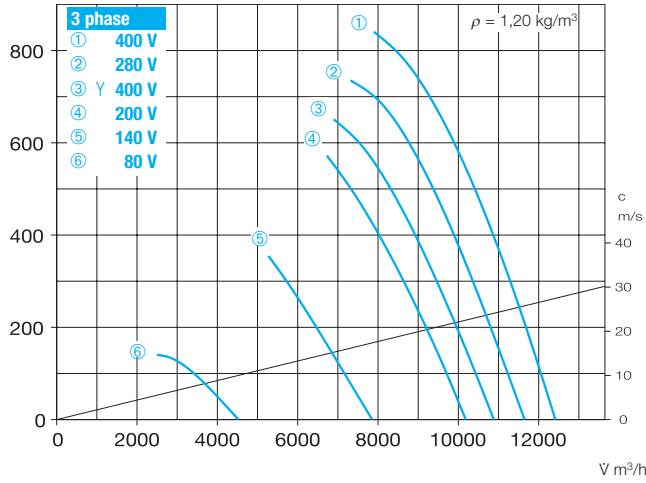

* 3 phase motor sound information. 1 phase motor sound information see www.HeliosSelect.de

400/4

Frequency*		Hz	Total	125	250	500	1k	2k	4k	8k
Δp_{fa}	L _{WA}	Sound noise	dB(A)	76	55	66	70	70	70	68
Pa	L _{PA,4m}	Sound noise	dB(A)	56	35	46	50	50	50	48

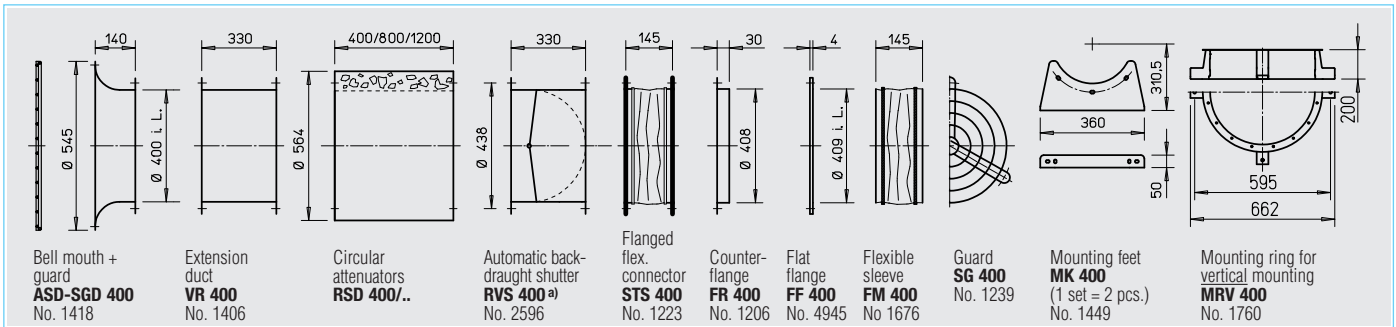
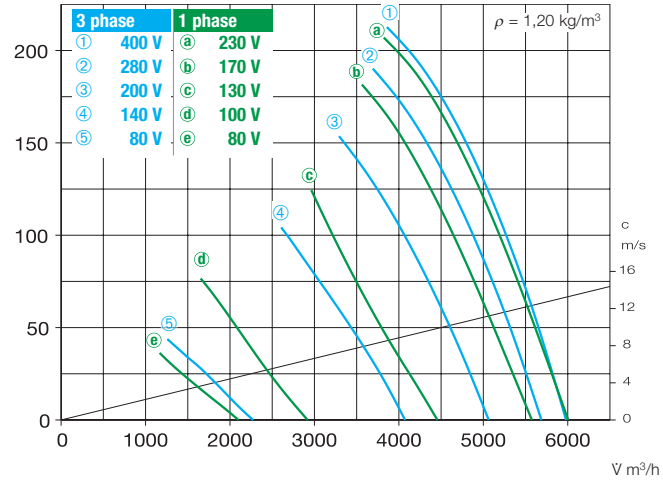

^{a)} For motorised shutters see accessory pages

* Type allocation see table, last column

	Full motor protection device for connection of thermal contacts	Vibration dampers				
		Compression		Suspension		
		Type	Ref. no.	Type	Ref. no.	
	MW	1579	SDD 1	1452	SDZ 1	1454
	MD	5849	SDD 1	1452	SDZ 1	1454
	M 4	1571	SDD 1	1452	SDZ 1	1454

Solutions for technical building equipment. Helios TGA.

In addition to the series range, Helios Ventilators offers an extensive product portfolio for technical building equipment (TGA). In addition to the medium-pressure axial fans on the pages below, further ND and various fire gas fan series are available in the temperature classes F300, F400 and F600, as well as impulse fans. Modern control and regulation solutions ensure the efficient and safe operation. With smarter properties, for example, gas warning systems fulfil the strictest demands in terms of safety, performance and energy and cost efficiency. See separate catalogue or get in touch with local representation for details.

AXIAL AND RADAX® VAR FANS



For areas of application in smoke extraction with conveyance temperatures of 300 °C or 400 °C and 600 °C for 120 minutes (F300, F400, F600) or 40 °C for continuous ventilation operations, the Helios TGA range comprises axial low-pressure, medium-pressure and RADAX® VAR high-pressure in-line fans in ND 280 to 1000 mm with a volume of 2500 – 115 000 m³/h.



IMPULSE FANS (JET FANS)

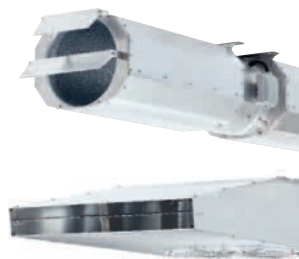

Impulse fans are used in underground car parks for ventilation and exhaust air extraction and guarantee the extraction of smoke in the case of a fire.

Low-noise and with universal applications, the Helios axial impulse fans are setting benchmarks when it comes to thrust and weight. The centrifugal models have an impressive ultra-flat, compact and light design and are ideal for restricted spaces.



FIRE GAS ROOF AND RECTANGULAR FANS



Fire gas roof fans are available with ND 315 to 710 mm with volumes of 3700 to 40 000 m³/h. They have DIBt application certificates and are CE-certified.

Fire gas rectangular fans for rectangular ducts and connections are ideally suited to areas of application with conveyor temperatures of 400 °C for 120 minutes (smoke extraction operation).



SMOKE PROTECTION FANS



Smoke protection pressure systems (RDA) and stairway flush ventilation systems (TSA) ensure that stairways, fire-fighting lifts and the like remain free from smoke in order to save lives.

The RDA / TSA concept from Helios has a modular design. With preconfigured packages, the entire system is put together in just a few steps and adapted to the structural conditions and property requirements. This guarantees seamless planning, installation and commissioning, as well as the all-round safe operation of the system.

■ Casing

- Duct casing with welded-in motor mounting plate and a guide wheel made of sheet steel. Flange pressed on both sides with DIN 24155 page 3 for direct placement of flanges in the middle of ducting.
- Surface protection through powder coating RAL 7015 (grey).

■ Impeller

- Hubs and vanes made of corrosion-resistant aluminium alloy.
- Dynamically balanced in accordance with DIN ISO 1940-1, grade 6.3 for low-vibration operation.
- Ten vanes with aerodynamic profiles work together with the guide wheel to achieve maximum efficiency and pressure.
- The pitch angle of the vanes can be factory pre-set according to the optimal bespoke operating point.

■ Motor

- A direct start connection is intended for single-speed fans with a three-phase motor and rated motor power of 3.00 kW, fans with rated motor power of 4.00 kW for the star-delta starting.
- Directly through an efficient IE 2 and IE3 three-phase standard motor. Pole-changeable fans with IEC standard motor. Degree of protection IP 55, insulation class F.

■ Speed control

Stepless (0–100 %) thanks to the use of a frequency inverter (excluding pole-changeable models). The planned use of a frequency inverter without sinus filter is to be stated when the contract is placed. It triggers a change of the fan design and added costs where applicable.

■ Motor protrusion

- In some types, the motor extends beyond the casing. Protrusion measurement B in mm is to be observed according to the type table.

■ Motor protection

- All AMD types have a PTC thermistor for motor protection as standard. This means that effective motor protection is possible using a full motor protection device (type MSA, Ref. no. 1289, accessory) or FU (accessory).

■ Electrical connection

- Polymer terminal box (degree of protection IP 55) as standard, fitted on the outside of the fan casing.

■ Ordering data

The desired pitch angle of the vanes must be stated during the order.

Example:

AMD 355/2 1.5 kW 34°

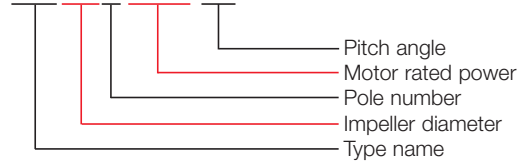

■ Air flow temperatures

- For ventilation and exhaust air extraction with long-term temperatures from -20 °C to +60 °C. Types for higher conveyor temperatures available upon request.

■ Airflow direction

- The fans have a pressed design with airflow direction B = above the motor (Fig. 1).

■ Sound levels

- The sound power values over the frequency and as summation of sound levels for various angles of incidence are stated above the characteristic curves on the product pages.

■ Installation

- Horizontal and vertical positioning, depending on the installation location.
- The use of vibration dampers (accessory) is recommended in order to prevent the transfer of vibrations.
- **Duct installation (tilting)**
An extension tube (type VR, accessory) (Figure 2) may need to be fitted in order to prevent overturning when fitting the medium-pressure axial fan with canvas connecting pieces on the intake side and exhaust side (type STS, accessory).
- **Duct installation**

Arrangement of the mounting brackets (type MK) for horizontal mounting or a mounting ring (type MRV) for vertical mounting with vibration dampers on the fan. Use of vibration dampers for pressure load (Type SDD, accessory) or tensile load (Type SDZ, accessory, when hanging from the ceiling).

- **Duct installation with attenuators on intake and exhaust sides**

According to the local circumstances, on-site brackets are necessary to attach the attenuator and to retain the weight. The attenuator on the intake side placed at the inlet, with the attenuator on the pressure side placed at the outlet must both

Fig. 1

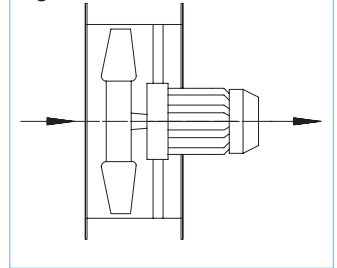
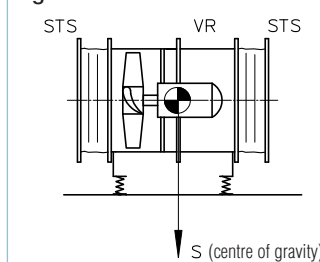

Fig. 2 CORRECT!



INCORRECT!

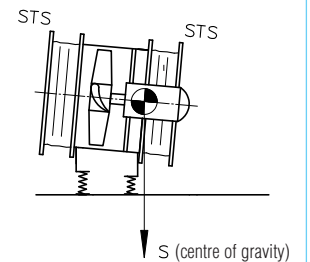

Fig. 3

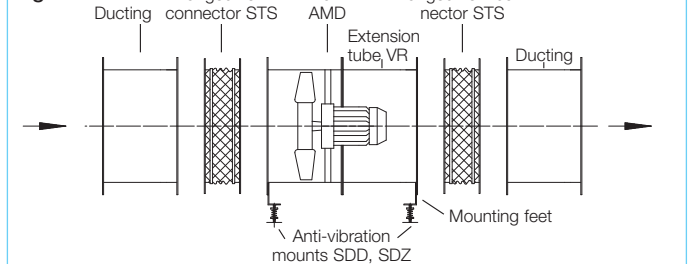

Fig. 4

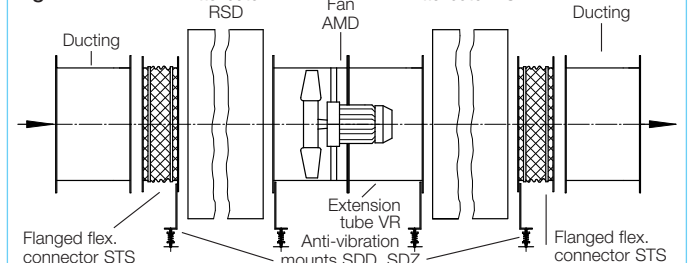
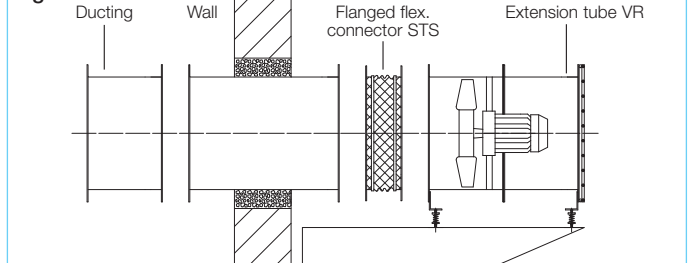

Fig. 5



be equipped with canvas connecting pieces (Type STS, accessory, figure 4).

□ Wall mounting (horizontal)

On the on-site brackets. Wall entrance with pipe or duct, immurement with mineral wool. Canvas connecting pieces (Type STS, accessory) on the suction and pressure side with extension duct (Type VR, accessory) and protective grille (Type SG, accessory, figure 5).

Information	Page
Information for planning	10 on
Installation accessories	230 on
Attenuators	436
Speed controller, pole switch	525 on



Fig. incl. mounting feet (MK, accessories)

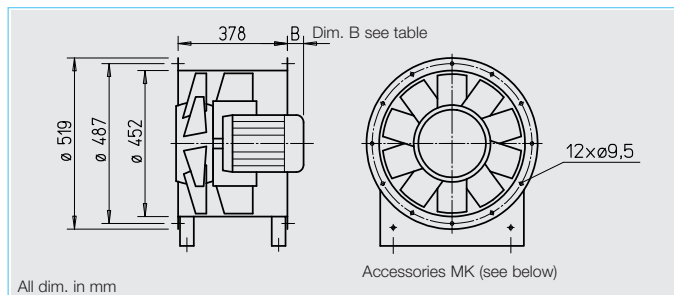

All dim. in mm

Accessories MK (see below)

■ Specification

□ Casing

Cylindrical duct with welded motor supporting plate and guide vane made of sheet steel. With flanges on both ends (except AVD DK) steel to DIN 24155 PT3. For direct in-line installation in ducting. Surface protection by powder coating RAL 7015 (grey).

□ Impeller

Hub and blades in corrosion resistant aluminium alloy. Dynamically balanced to DIN ISO 1940-1, class 6.3 for low vibration operation. Ten aerodynamically profiled blades achieve highest efficiency and pressure rates in cooperation with the guide vane. The pitch angle of the blades is adjustable at standstill and factory set.

□ Motor

Direct through efficient IE 2 or IE 3 standard three phase motor. Pole-switchable fans with IEC standard motor. Protection to IP 55, insulation class F.

□ Speed control

Stepless (0-100 %) by use of frequency inverters. The planned use of a frequency inverter without sine filter must be stated when ordering. This causes a change of the fan execution and if necessary additional costs.

□ Electrical connection

Standard terminal box (protection to IP 55) from polymer, mounted on the outside of the casing.

□ Motor protection

All AMD types are equipped with PTC thermistors as motor protection as standard. Effective motor protection is possible by means of full motor protection device (Type MSA, Ref. no. 1289, accessories) or FU (accessories).

□ Dimensions

For some types, the motor protrudes out of the casing. Overhang dim. B in mm can be seen in the table below.

□ Sound levels

The sound power values concerning the frequency and as sum levels for different pitch angles are indicated on the product pages above the characteristic curves.

■ Information Page

Information for planning 10 on

Made to order designs

Special design with inspection opening (add. price) on request.

■ Other accessories Page

Installation accessories 230 on

Attenuators 436 on

Switch and control technology 525 on

Type	Ref. no.	R.P.M.	Air flow volume (FID)	Motor power (output)	Voltage	Current	Dim. B motor overhang	Wiring diagram	Max. air flow temp.	Weight net approx.	Frequency inverter with integrated sine filter	Full motor protection or pole switch		
		min ⁻¹	V m ³ /h	kW	V	A	mm	No.	+°C	kg	Type	Ref. no.	Type	Ref. no.
3 phase motor, 400 V, 50 Hz, protection to IP 55														
AMD 450/4 0,75 kW	3109	1420	8930	0.75	400	1.8	15	796	60	40	FU-BS 2,5	5459	MSA	1289
AMD 450/4 1,1 kW	3110	1390	10120	1.1	400	2.6	40	796	60	44	FU-BS 5,0	5460	MSA	1289
AMD 450/2 2,2 kW	3106	2880	10850	2.2	400	4.5	65	796	60	47	FU-BS 5,0	5460	MSA	1289
AMD 450/2 3 kW	3107	2880	12380	3	400	5.9	105	796	60	54	FU-BS 8,0	5461	MSA	1289
AMD 450/2 4 kW	3108	2900	14970	4	400*	7.6	155	776	60	57	FU-BS 8,0	5461	MSA	1289
Pole-switchable, 2-speed, 3 phase motor, Dahlander winding Y/YY, 400 V, 50 Hz, protection to IP 55												Pole switch surface		
AMD 450/4/2 0,65/2,5 kW	3121	1380/2855	5660/11660	0.65/2.5	400	1.9/5.0	40	777	60	61	—	—	PDA 12 ¹⁾	5081
AMD 450/4/2 0,8/3,1 kW	3111	1380/2860	6200/12380	0.8/3.1	400	2.1/6.1	65	777	60	61	—	—	PDA 12 ¹⁾	5081
AMD 450/4/2 1,1/4,4 kW	3113	1390/2860	7630/15780	1.1/4.4	400	3.0/8.7	155	777	60	67	—	—	PDA 12 ¹⁾	5081

The pitch angle should be stated when ordering.

¹⁾ Flush mounted version see switch product page.

* Y/Δ start-up

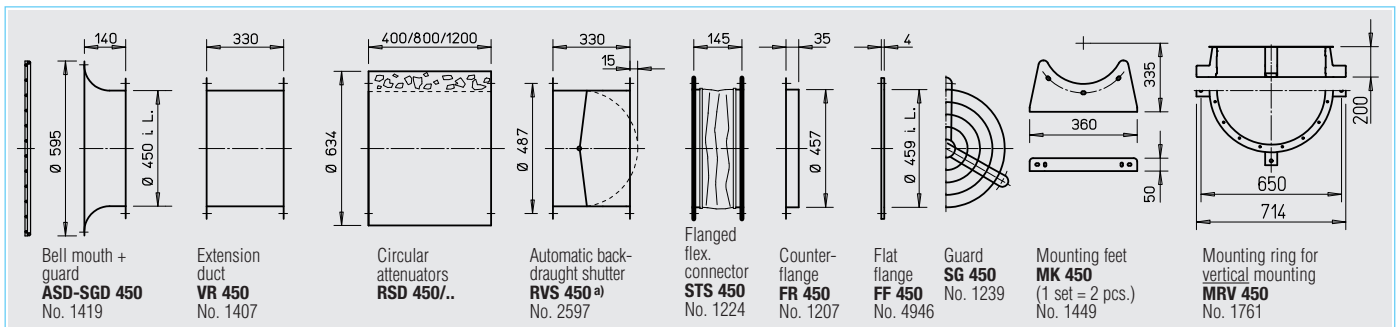
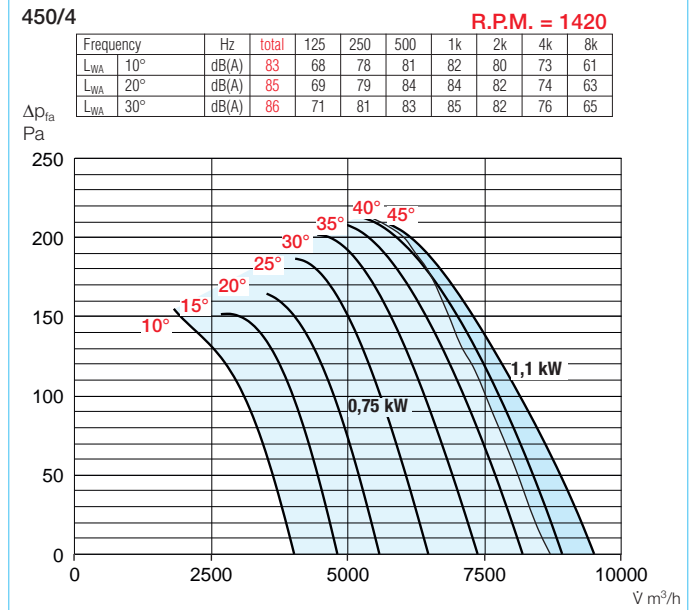
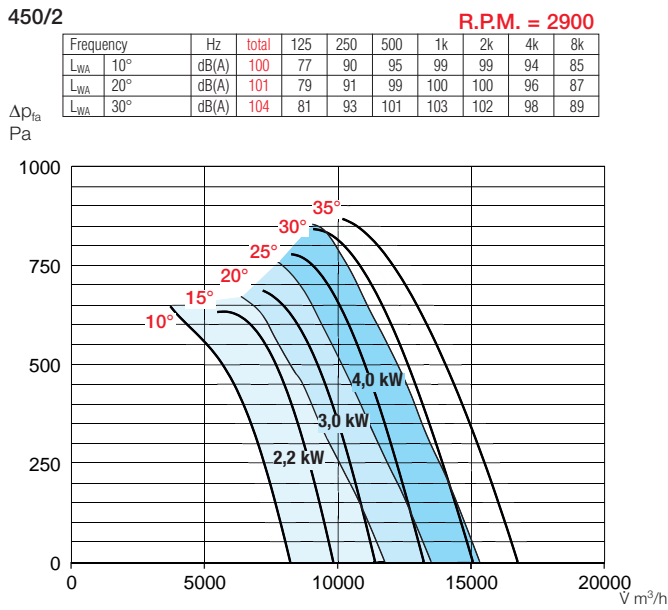

^{a)} For motorised shutters see accessory pages

Vibration dampers			
Compression		Suspension	
Type	Ref. no.	Type	Ref. no.
SDD 1	1452	SDZ 1	1454
SDD 1	1452	SDZ 1	1454
SDD 1	1452	SDZ 1	1454
SDD 1	1452	SDZ 1	1454
SDD 1	1452	SDZ 1	1454
SDD 1	1452	SDZ 2	1455
SDD 1	1452	SDZ 2	1455
SDD 1	1452	SDZ 2	1455



Fig. incl. mounting feet (MK, accessories)

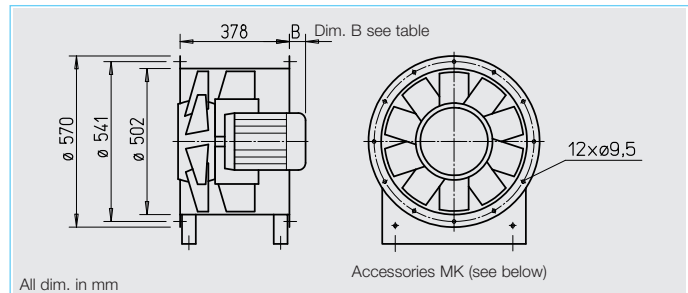

■ Specification

□ Casing

Cylindrical duct with welded motor supporting plate and guide vane made of sheet steel. With flanges on both ends (except AVD DK) steel to DIN 24155 PT3. For direct in-line installation in ducting. Surface protection by powder coating RAL 7015 (grey).

□ Impeller

Hub and blades in corrosion resistant aluminium alloy. Dynamically balanced to DIN ISO 1940-1, class 6.3 for low vibration operation. Ten aerodynamically profiled blades achieve highest efficiency and pressure rates in cooperation with the guide vane. The pitch angle of the blades is adjustable at standstill and factory set.

□ Motor

Direct through efficient IE 2 or IE 3 standard three phase motor. Pole-switchable fans with IEC standard motor. Protection to IP 55, insulation class F.

□ Speed control

Stepless (0-100 %) by use of frequency inverters. The planned use of a frequency inverter without sine filter must be stated when ordering. This causes a change of the fan execution and if necessary additional costs.

□ Electrical connection

Standard terminal box (protection to IP 55) from polymer, mounted on the outside of the casing.

□ Motor protection

All AMD types are equipped with PTC thermistors as motor protection as standard. Effective motor protection is possible by means of full motor protection device (Type MSA, Ref. no. 1289, accessories) or FU (accessories).

□ Dimensions

For some types, the motor protrudes out of the casing. Overhang dim. B in mm can be seen in the table below.

□ Sound levels

The sound power values concerning the frequency and as sum levels for different pitch angles are indicated on the product pages above the characteristic curves.

Information	Page
Information for planning	10 on
Made to order designs	
Special design with inspection opening (add. price) on request.	

Other accessories	Page
Installation accessories	230 on
Attenuators	436 on
Switch and control technology	525 on

Type	Ref. no.	R.P.M.	Air flow volume (FID)	Motor power (output)	Voltage	Current	Dim. B motor overhang	Wiring diagram	Max. air flow temp.	Weight net approx.	Frequency inverter with integrated sine filter		Full motor protection or pole switch	
											Type	Ref. no.	Type	Ref. no.
3 phase motor, 400 V, 50 Hz, protection to IP 55														
AMD 500/4 0,75 kW	3118	1420	9420	0.75	400	1.8	35	796	60	46	FU-BS 2,5	5459	MSA	1289
AMD 500/4 1,1 kW	3119	1390	11600	1.1	400	2.6	60	796	60	50	FU-BS 5,0	5460	MSA	1289
AMD 500/4 1,5 kW	3122	1420	13250	1.5	400	3.5	85	796	60	53	FU-BS 5,0	5460	MSA	1289
AMD 500/2 4 kW	3115	2900	15620	4	400*	7.6	175	776	60	83	FU-BS 8,0	5461	MSA	1289
AMD 500/2 5,5 kW	3116	2910	17600	5.5	400*	10.4	180	776	60	97	FU-BS 14	5463	MSA	1289
AMD 500/2 7,5 kW	3117	2940	21570	7.5	400*	13.7	220	776	60	102	FU-BS 14	5463	MSA	1289
Pole-switchable, 2-speed, 3 phase motor, Dahlander winding Y/YY, 400 V, 50 Hz, protection to IP 55														
													Pole switch surface	
AMD 500/8/4 0,22/1,0 kW	3275	645/1390	5660/11400	0.22/1.0	400	0.9/2.4	60	777	60	55	—	—	PDA 12 ¹⁾	5081
AMD 500/8/4 0,3/1,3 kW	3276	645/1390	6250/12630	0.3/1.3	400	1.6/3.3	85	777	60	58	—	—	PDA 12 ¹⁾	5081
AMD 500/4/2 1,4/5,9 kW	3273	1400/2900	9030/18600	1.4/5.9	400	3.6/11.4	180	777	60	118	—	—	PDA 12 ¹⁾	5081
AMD 500/4/2 2,0/8,0 kW	3274	1410/2900	10900/22600	2.0/8.0	400	4.7/14.9	220	777	60	129	—	—	PDA 25	5060

The pitch angle should be stated when ordering.

¹⁾ Flush mounted version see switch product page.

²⁾ Extension duct VR.. required over the motor overhang.

* Y/Δ start-up

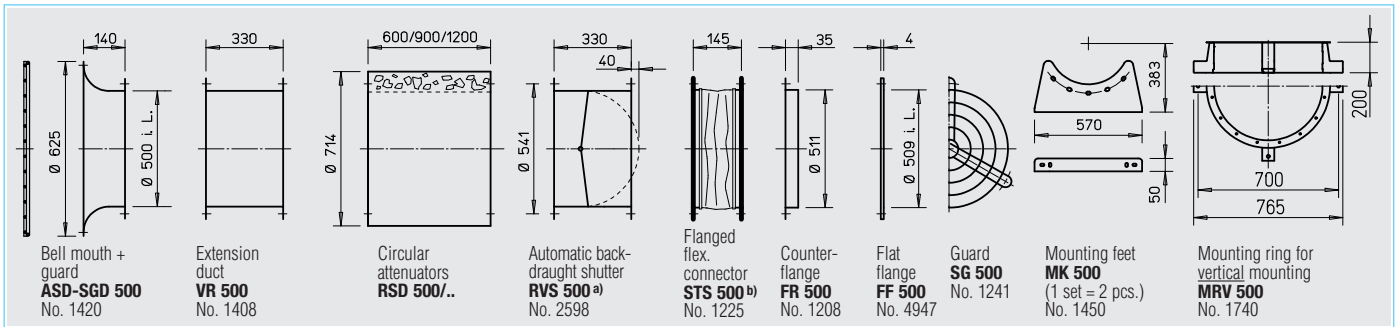
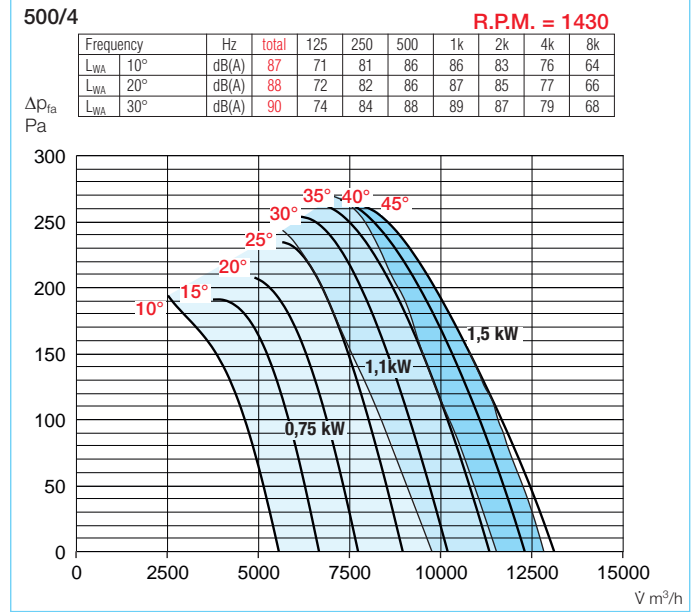
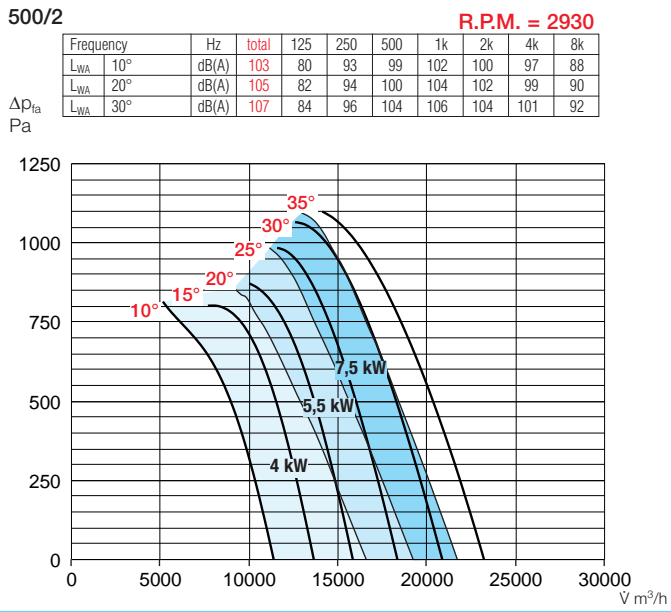

^{a)} For motorised shutters see accessory pages

Vibration dampers			
Compression		Suspension	
Type	Ref. no.	Type	Ref. no.
SDD 1	1452	SDZ 1	1454
SDD 1	1452	SDZ 1	1454
SDD 1	1452	SDZ 1	1454
SDD 2	1453	SDZ 2	1455
SDD 2 ²⁾	1453	SDZ 2 ²⁾	1455
SDD 2 ²⁾	1453	SDZ 2 ²⁾	1455
SDD 1	1452	SDZ 1	1454
SDD 1	1452	SDZ 2	1455
SDD 2 ²⁾	1453	SDZ 2 ²⁾	1455
SDD 2 ²⁾	1453	SDZ 2 ²⁾	1455



Fig. incl. mounting feet (MK, accessories)

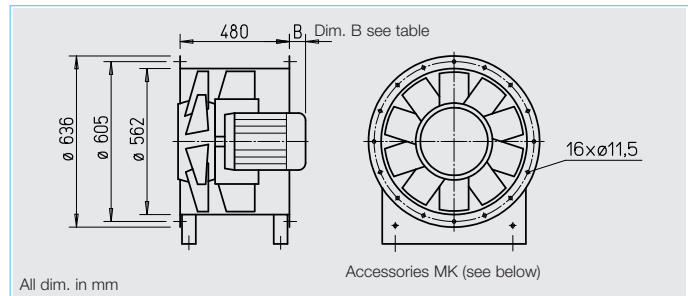

■ Specification

□ Casing

Cylindrical duct with welded motor supporting plate and guide vane made of sheet steel. With flanges on both ends (except AVD DK) steel to DIN 24155 PT3. For direct in-line installation in ducting. Surface protection by powder coating RAL 7015 (grey).

□ Impeller

Hub and blades in corrosion resistant aluminium alloy. Dynamically balanced to DIN ISO 1940-1, class 6.3 for low vibration operation. Ten aerodynamically profiled blades achieve highest efficiency and pressure rates in cooperation with the guide vane. The pitch angle of the blades is adjustable at standstill and factory set.

□ Motor

Direct through efficient IE 2 or IE 3 standard three phase motor. Pole-switchable fans with IEC standard motor. Protection to IP 55, insulation class F.

□ Speed control

Stepless (0-100 %) by use of frequency inverters. The planned use of a frequency inverter without sine filter must be stated when ordering. This causes a change of the fan execution and if necessary additional costs.

□ Electrical connection

Standard terminal box (protection to IP 55) from polymer, mounted on the outside of the casing.

□ Motor protection

All AMD types are equipped with PTC thermistors as motor protection as standard. Effective motor protection is possible by means of full motor protection device (Type MSA, Ref. no. 1289, accessories) or FU (accessories).

□ Dimensions

For some types, the motor protrudes out of the casing. Overhang dim. B in mm can be seen in the table below.

□ Sound levels

The sound power values concerning the frequency and as sum levels for different pitch angles are indicated on the product pages above the characteristic curves.

Information	Page
Information for planning	10 on
Made to order designs	
Special design with inspection opening (add. price) on request.	

Other accessories	Page
Installation accessories	230 on
Attenuators	436 on
Switch and control technology	525 on

Type	Ref. no.	R.P.M.	Air flow volume (FID)	Motor power (output)	Voltage	Current	Dim. B motor overhang	Wiring diagram	Max. air flow temp.	Weight net approx.	Frequency inverter with integrated sine filter	Full motor protection or pole switch
		min ⁻¹	V m ³ /h	kW	V	A	mm	No.	+°C	kg	Type Ref. no.	Type Ref. no.
3 phase motor, 400 V, 50 Hz, protection to IP 55												
AMD 560/4 1,1 kW	3281	1390	11870	1.1	400	2.6	0	796	60	61	FU-BS 5,0 5460	MSA 1289
AMD 560/4 1,5 kW	3282	1420	14750	1.5	400	3.5	0	796	60	64	FU-BS 5,0 5460	MSA 1289
AMD 560/4 2,2 kW	3285	1440	17600	2.2	400	4.7	40	796	60	74	FU-BS 5,0 5460	MSA 1289
AMD 560/4 3 kW	3286	1440	19520	3	400	6.2	40	796	60	80	FU-BS 8,0 5461	MSA 1289
AMD 560/2 7,5 kW	3279	2940	22000	7.5	400*	13.7	100	776	60	123	FU-BS 14 5463	MSA 1289
Pole-switchable, 2-speed, 3 phase motor, Dahlander winding Y/YY, 400 V, 50 Hz, protection to IP 55												
												Pole switch surface
AMD 560/8/4 0,55/2,0 kW	3272	680/1410	8150/16500	0.55/2.0	400	2.0/4.5	0	777	60	79	— —	PDA 12 ¹⁾ 5081
AMD 560/8/4 0,65/2,4 kW	3290	680/1410	8740/18160	0.65/2.4	400	2.5/5.5	40	777	60	79	— —	PDA 12 ¹⁾ 5081
AMD 560/4/2 2,0/8,0 kW	3287	1410/2900	11280/23150	2.0/8.0	400	4.7/14.9	100	777	60	149	— —	PDA 25 5060

The pitch angle should be stated when ordering.

¹⁾ Flush mounted version see switch product page.

* Y/Δ start-up

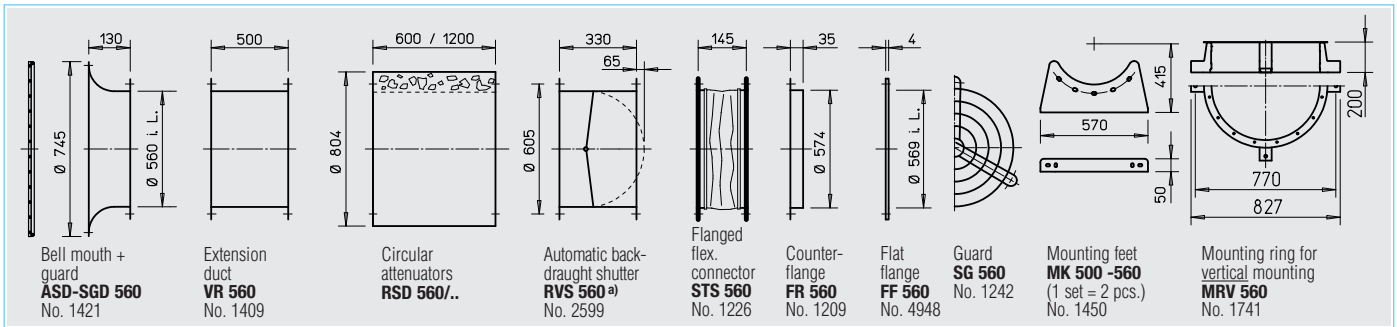
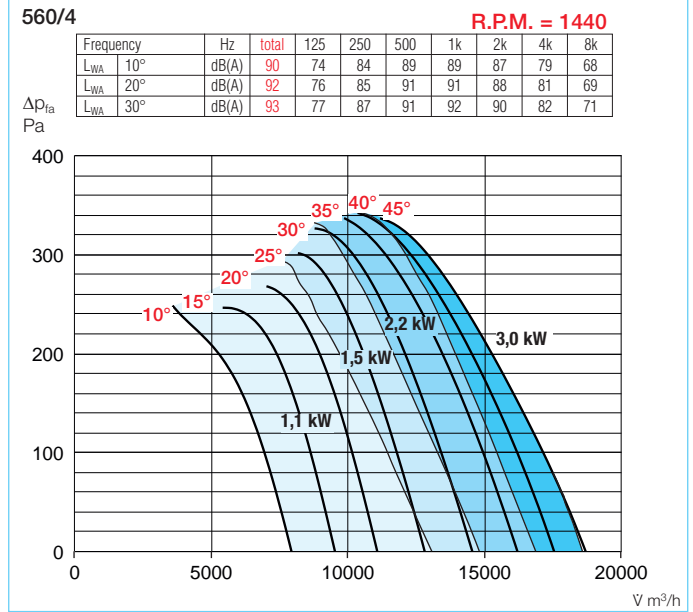
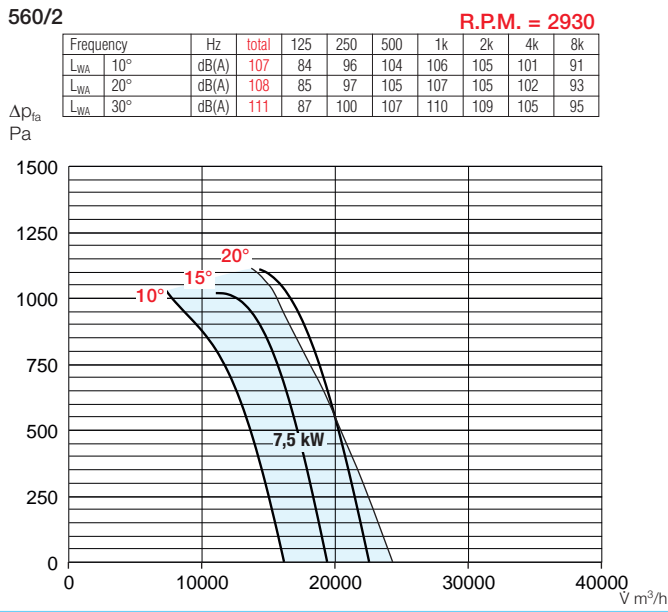

a) For motorised shutters see accessory pages

Vibration dampers			
Compression		Suspension	
Type	Ref. no.	Type	Ref. no.
SDD 1	1452	SDZ 2	1455
SDD 1	1452	SDZ 2	1455
SDD 1	1452	SDZ 2	1455
SDD 2	1453	SDZ 2	1455
SDD 2	1453	SDZ 2	1455
SDD 2	1453	SDZ 2	1455
SDD 2	1453	SDZ 2	1455
SDD 2	1453	SDZ 2	1455



Fig. incl. mounting feet (MK, accessories)

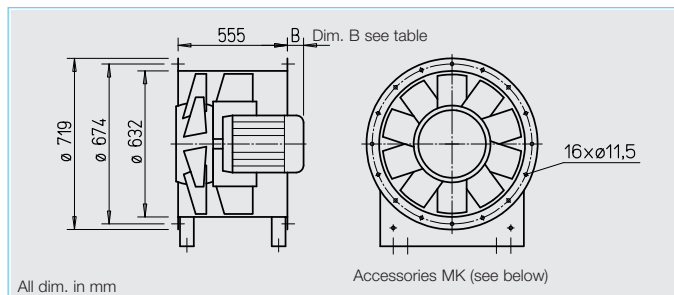

■ Specification

□ Casing

Cylindrical duct with welded motor supporting plate and guide vane made of sheet steel. With flanges on both ends (except AVD DK) steel to DIN 24155 PT3. For direct in-line installation in ducting. Surface protection by powder coating RAL 7015 (grey).

□ Impeller

Hub and blades in corrosion resistant aluminium alloy. Dynamically balanced to DIN ISO 1940-1, class 6.3 for low vibration operation. Ten aerodynamically profiled blades achieve highest efficiency and pressure rates in cooperation with the guide vane. The pitch angle of the blades is adjustable at standstill and factory set.

□ Motor

Direct through efficient IE 2 or IE 3 standard three phase motor. Pole-switchable fans with IEC standard motor. Protection to IP 55, insulation class F.

□ Speed control

Stepless (0-100 %) by use of frequency inverters. The planned use of a frequency inverter without sine filter must be stated when ordering. This causes a change of the fan execution and if necessary additional costs.

□ Electrical connection

Standard terminal box (protection to IP 55) from polymer, mounted on the outside of the casing.

□ Motor protection

All AMD types are equipped with PTC thermistors as motor protection as standard. Effective motor protection is possible by means of full motor protection device (Type MSA, Ref. no. 1289, accessories) or FU (accessories).

□ Dimensions

For some types, the motor protrudes out of the casing. Overhang dim. B in mm can be seen in the table below.

□ Sound levels

The sound power values concerning the frequency and as sum levels for different pitch angles are indicated on the product pages above the characteristic curves.

Information	Page
Information for planning	10 on
Made to order designs	
Special design with inspection opening (add. price) on request.	

Other accessories	Page
Installation accessories	230 on
Attenuators	436 on
Switch and control technology	525 on

Type	Ref. no.	R.P.M.	Air flow volume (FID)	Motor power (output)	Voltage	Current	Dim. B motor overhang	Wiring diagram	Max. air flow temp.	Weight net approx.	Frequency inverter with integrated sine filter	Full motor protection or pole switch
		min ⁻¹	V m ³ /h	KW	V	A	mm	No.	+° C	kg	Type Ref. no.	Type Ref. no.
3 phase motor, 400 V, 50 Hz, protection to IP 55												
AMD 630/4 1,5 kW	3291	1420	14390	1.5	400	3.5	0	796	60	84	FU-BS 5,0 5460	MSA 1289
AMD 630/4 2,2 kW	3292	1440	18500	2.2	400	4.7	0	796	60	84	FU-BS 5,0 5460	MSA 1289
AMD 630/4 3 kW	3293	1440	21400	3.0	400	6.2	0	796	60	99	FU-BS 8,0 5461	MSA 1289
AMD 630/4 4 kW	3294	1445	25130	4.0	400*	8.1	30	776	60	94	FU-BS 10 5462	MSA 1289
AMD 630/4 5,5 kW	3295	1450	27700	5.5	400*	11.1	40	776	60	115	FU-BS 14 5463	MSA 1289
AMD 630/2 11 kW	3376	2940	32000	11.0	400*	20.0	145	776	60	210	—	MSA 1289
Pole-switchable, 2-speed, 3 phase motor, Dahlander winding Y/YY, 400 V, 50 Hz, protection to IP 55												Pole switch surface
AMD 630/8/4 0,55/2,0 kW	3297	680/1410	8030/16660	0.55/2.0	400	2.00/4.5	0	777	60	98	—	PDA 12 ¹⁾ 5081
AMD 630/8/4 0,9/3,2 kW	3298	680/1420	11000/21750	0.9/3.2	400	3.2/7.1	30	777	60	104	—	PDA 12 ¹⁾ 5081
AMD 630/8/4 1,1/4,5 kW	3299	680/1435	13260/26450	1.1/4.5	400	3.6/9.3	40	777	60	130	—	PDA 12 ¹⁾ 5081

The pitch angle should be stated when ordering.

¹⁾ Flush mounted version see switch product page.

* Y/Δ start-up

630/2

R.P.M. = 2940

Frequency	Hz	total	125	250	500	1k	2k	4k	8k	
L _{WA} 10°		dB(A)	112	84	97	104	108	106	101	92
L _{WA} 20°		dB(A)	114	87	99	107	110	109	104	95
L _{WA} 30°		dB(A)	116	89	101	109	112	111	106	97

Δp_{ia}
Pa

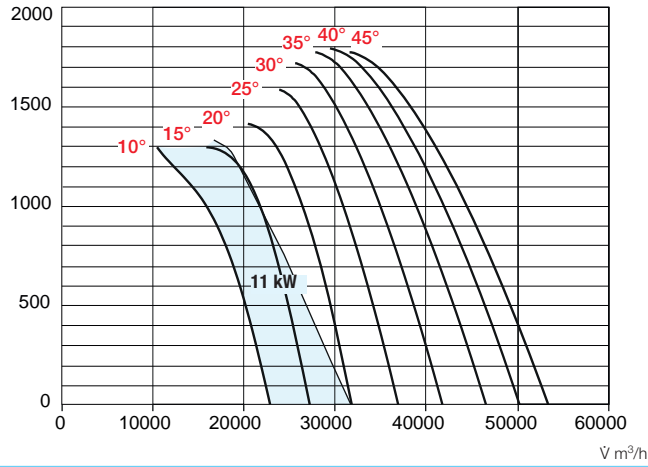

630/4

R.P.M. = 1450

Frequency	Hz	total	125	250	500	1k	2k	4k	8k	
L _{WA} 10°		dB(A)	94	78	87	93	93	90	83	71
L _{WA} 20°		dB(A)	95	79	89	92	94	91	84	72
L _{WA} 30°		dB(A)	97	81	91	95	96	93	86	74

Δp_{ia}
Pa

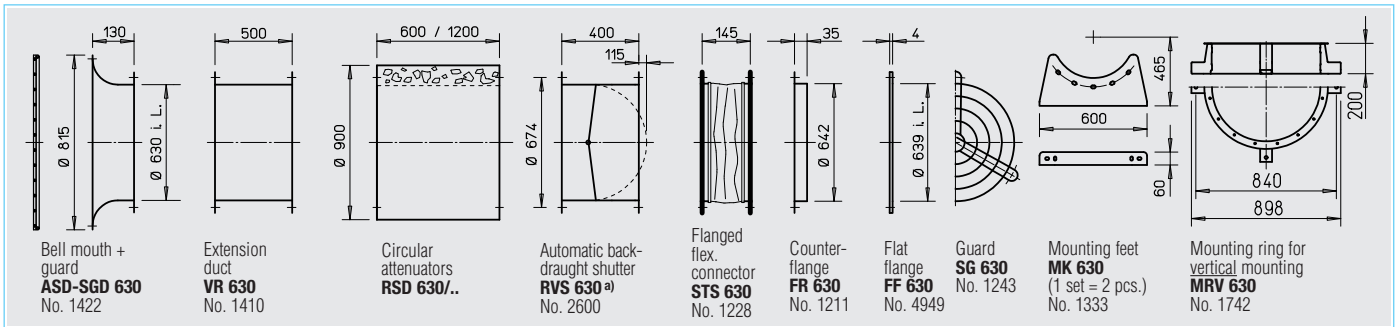
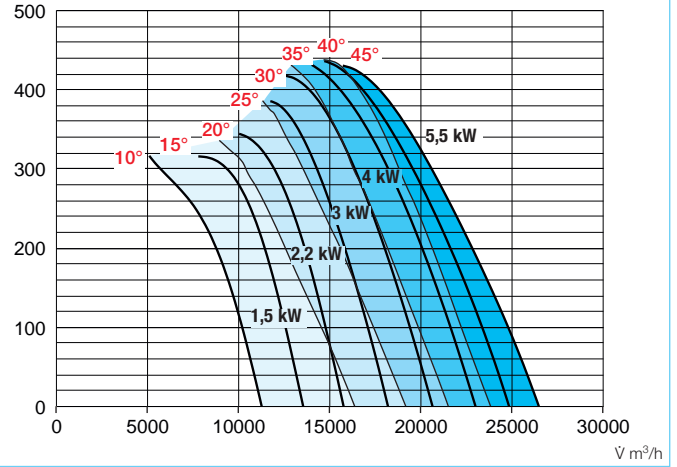

^{a)} For motorised shutters see accessory pages

Vibration dampers			
Compression		Suspension	
Type	Ref. no.	Type	Ref. no.
SDD 2	1453	SDZ 2	1455
SDD 2	1453	SDZ 2	1455
SDD 2	1453	SDZ 2	1455
SDD 2	1453	SDZ 2	1455
SDD 2	1453	SDZ 2	1455
—	—	—	—
SDD 2	1453	SDZ 2	1455
SDD 2	1453	SDZ 2	1455
SDD 2	1453	SDZ 2	1455

Centrifugal performance characteristics with axial flow pattern: RADAX® VAR

COMPACT



In their compact casing, the RADAX® VAR impellers ensure high pressure and a large volume conveyed. The VAR's recipe for success lies in the combination of the performance characteristics of centrifugal fans with an axial flow pattern. Guiding the air in a straight line improves the efficiency and allows a significant reduction of the space required, as well as savings in terms of the ducting system.

PRESSURE-RESISTANT



This synergy has enormous benefits:

- Maximum performance with low energy costs.
- Low sound levels.
- High-pressures and volumes with the smallest of dimensions.
- Can be used universally.
- Freedom of planning.
- No need for deflections and shaped pieces on-site with the related resistances.
- Low installation costs.

UNIVERSAL



In addition to single phase types, the RADAX® VAR range offers the following:

- More Ø up to 1000 mm
- B VAR types for the smoke extraction insert pursuant to DIN 12101-3 F300 (60 min.) or F400, F600 (120 min.).
- Parallel units with large volumes and high pressures for garage ventilation (VDI 2053).
- Two-stage TwinVent® with maximum pressure values.

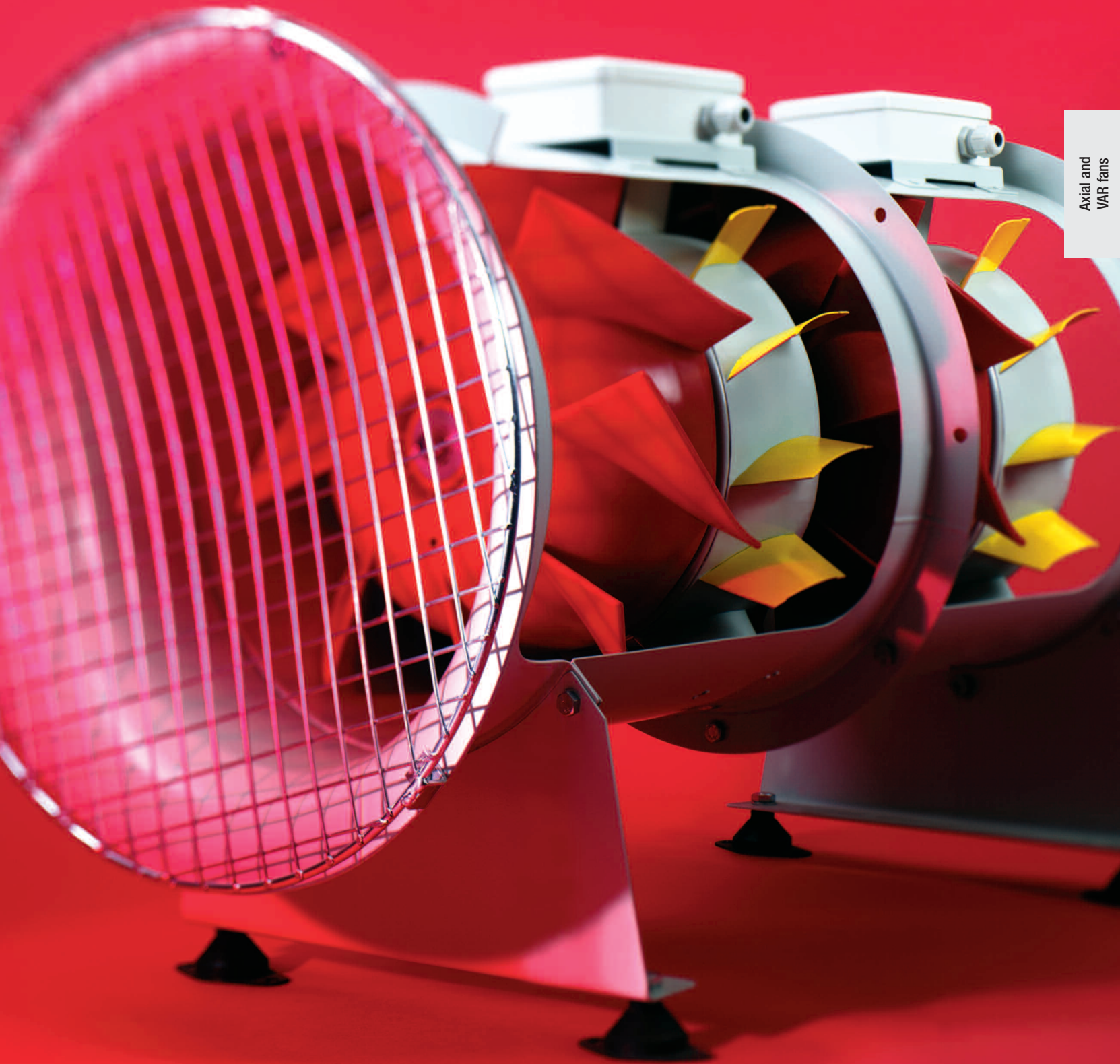

Axial and VAR fans

This information completes the "General Technical Information" section.

Features

RADAX® VAR is a range of high pressure in-line fans, combining the advantages of axial and centrifugal fans.

The mixed flow impeller combined with the fixed guide vanes are designed to provide high air flows and pressures very efficiently.

Air flow

The axial air flow pattern allows operation without loss, guide vanes improve and straighten the air and increase the efficiency of the fan. The VAR in-line installation eliminates the need for bulky bends, transformation pieces etc. including their resistances. This saves installation and energy costs.

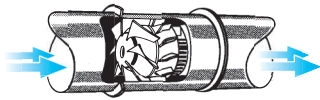

Casing

Casing flanges on both sides to DIN 24155, Pt.3 with guide vanes and motor support made from galvanised steel. Models with R.P.M. = 2800 of size 400, 450, 500 as well as all models of size 630 welded casing, hot-dip galvanised. Terminal box to IP 55 fixed to the outer casing.

Impeller

Mixed flow impeller with 8 spacious curved blades. Up to size 355 made from polymer. Models with R.P.M. = 2800 of size 355 as well as all models of size 400 to 630 made from hot-dip galvanised steel. Aluminium is available (additional charge) on demand.

VAR fans offer high efficiency, low operation noise, high corrosion resistance and low vibration operation through dynamic balance to DIN ISO 1940 Pt. 1 – quality grade 6.3.

Air flow temperature

The standard models are suitable in the range from -30 °C to at least +40 °C. See also information on product pages. Higher temperature models are available on request.

Explosion protection

The ex-proof models conform to cluster II, category 2G for operation in zone 1 or 2. According to Directive 2014/34/EU (ATEX), larger air gaps are specified which lead to a power reduction of up to 10%.

Air flow direction

The air flow of the fan cannot be reversed, however the fan is suitable for installation in any position. The correct direction of rotation and air flow are marked on the fan.

Installation position, mounting, condensation openings

To achieve the performance figures shown, a straight duct of 2 times the diameter in length downstream of the fan is required (and installed in ducting ideally the same upstream) (Figure 1).

RADAX® VAR can be installed in any position. Where motor condensate drainage is used, ensure the drain holes face downwards.

When installing the fan for vertical airflow as well as in an outside position or in a permanently humid or wet atmosphere, this must be specified at time of ordering.

On site assembly and mounting must be carried in such a way that the vertically fitted fan is distortion-free and safe.

Positioning

To avoid transmission of vibration between fan and building the use of anti vibration mounts is recommended (accessory SDD, SDZ). Larger motors may protrude to the rear and cause uneven distribution due to their high weight. An extension duct VR (accessories) is provided to determine the centre of gravity!

Installation examples

Horizontal

Figure 2

Free intake, ducted on exhaust. Mounted on ceiling, wall or floor.

Figure 3

Free intake with attenuator, ducted on exhaust. To reduce inlet and exhaust noise levels, attenuators can be fitted to both ends of the fan.

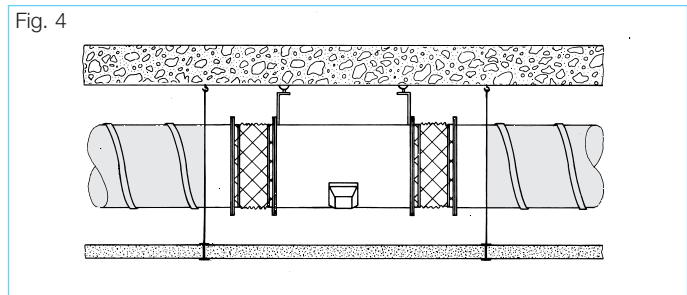
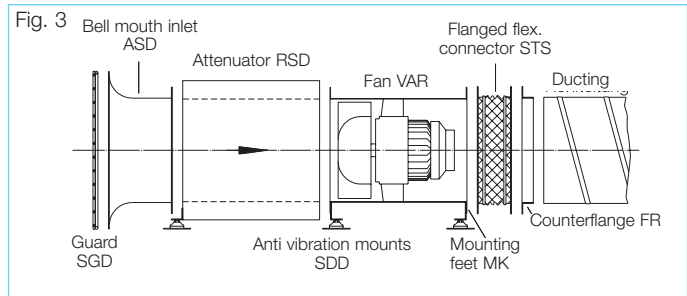
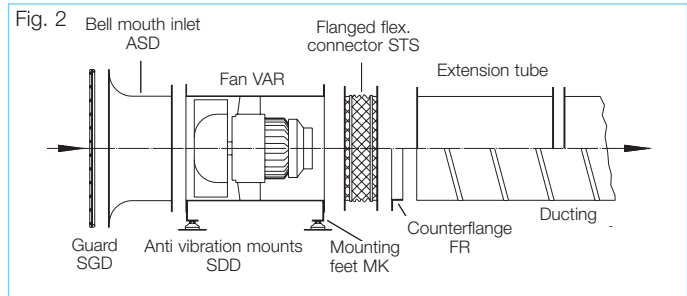
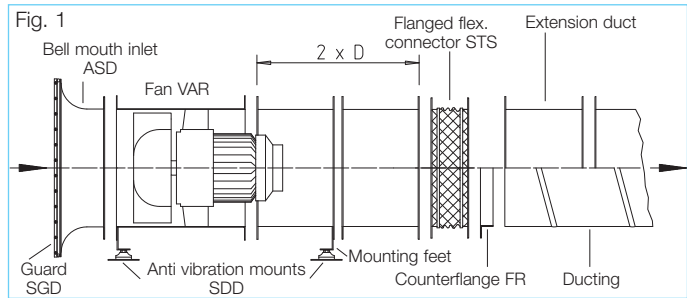

Figure 4

Ceiling suspension

Figure 4 shows the typical installation for ventilation. The installation of VAR systems is possible without any additional expenses through direct suspension on ceilings or walls. The casing is designed for straight in-line installation using the flanged ends (to DIN 24155 Pt. 3).

Vertical

Figure 5

In-line wall mounted installation with attenuator on intake. The accessories should be fixed separately to ensure that the fan may be easily removed for maintenance.

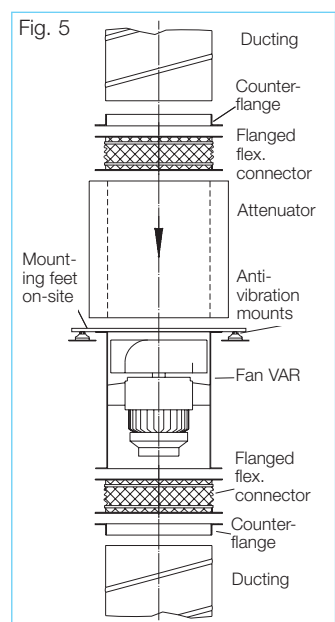

Information	Page
Information for planning, Acoustics, explosion prot.	10 on
General technical information, speed control	15 on

The following table facilitates the selection of RADAX® VAR high pressure fans by combining the parameters of static pressure Δp_{sta} , air flow volume V , speed min^{-1} , sound pressure level dB(A) and impeller diameter DN mm.

Sizes from Ø 710 mm as well as twin and parallel VAR units are shown in a separate catalogue.

Diameter	R.P.M.	Sound pressure level - intake	Air flow volume V m ³ /h against static pressure = N / m^2 = free available pressure												
mm	min ⁻¹	L_{PA} dB(A)	(Δp_{sta}) in Pa												
		at 4 m	0	50	100	150	200	300	400	500	600	700	800	900	1000
225	2800	61	1770	1700	1600	1510	1400								
225	1450	46	900	730											
250	2800	64	2540	2450	2350	2250	2150	1910							
250	1450	49	1250	1050											
280	2800	68	3320	3220	3110	3010	2900	2670	2360						
280	1450	52	1630	1400	1000										
315	2800	71	4670	4550	4430	4310	4200	3930	3650	3280					
315	1450	56	2510	2300	2060	1730									
355	2800	75	7220	7080	6980	6850	6700	6450	6150	5850	5500	5050			
355	1450	60	3540	3300	3050	2750	2200								
400	2800	78	10150	10000	9850	9700	9600	9300	9000	8700	8350	7950	7500	7100	6400
400	1450	63	5260	4950	4650	4310	3930								
400	930	52	3500	3060	2290										
450	2800	83	14200	14100	13900	13750	13600	13300	12900	12500	12200	11800	11400	10800	10350
450	1450	67	7280	6950	6650	6300	5900	4800							
450	930	56	4990	4520	3870										

Diameter	R.P.M.	Sound pressure level - intake	Air flow volume V m ³ /h against static pressure = N / m^2 = free available pressure												
mm	min ⁻¹	L_{PA} dB(A)	(Δp_{sta}) in Pa												
		at 4 m	0	150	300	450	600	750	900	1050	1200	1550	1800		
500	2800	86	22310	21800	21400	20800	20300	19750	19200	18600	17900	16000	13500		
500	1450	70	9700	8640	7300										
500	930	59	6860	5150											
560	1450	73	13550	12500	11300	9850									
560	930	63	9850	8110											
560	725	56	7510												
630	1450	77	21460	20410	19110	17610	15760								
630	930	67	14040	12190	8740										
630	725	60	10690	7810											
The following sizes are shown in a separate catalogue.															
710	1480	81	31350	30210	28920	27370	25680	23710	20790						
710	950	70	20110	18120	15390										
710	725	64	15330	12380											
800	1480	85	44870	43580	42210	40610	38810	36910	34780	32130	26670				
800	950	74	28770	26640	23850	19970									
800	725	67	21940	18810											
900	1480	88	63890	62450	60940	59300	57440	55410	53310	50990	48420	39610			
900	950	78	40990	38650	35710	32250	26830								
900	725	71	31260	27910	23160										
1000	1480	92	87640	86050	84410	82590	80770	78650	76400	74110	71650	66090	57450		
1000	950	81	56220	53690	50670	47080	42960	36050							
1000	725	74	42880	39330	34590	25090									

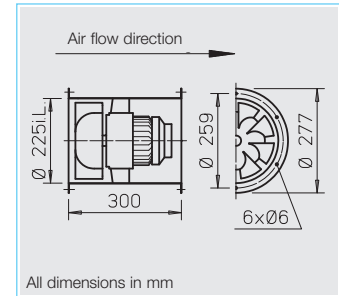

■ Specification

□ Casing

Manufactured in galvanised sheet steel with flanges on both sides to DIN 24155, Pt. 3, with fixed guide vanes and motor support.

□ Impeller

Optimised for high pressure and performance. Specially developed mixed-flow curved impeller manufactured from impact resistant polymers.

□ Motor

Direct driven, maintenance free flange motor, totally enclosed with an aluminium casing and cooling fins, protected to IP 54. Sealed for life ball bearings with tropicalized protection of windings and radio suppression. Optional drainage holes made to order (please state installation position).

□ Speed control

For all speed controllable models the current is given in the “speed controlled” column of the table below which must be used when selecting a controller (see controller column). The air flow volumes can be seen from the characteristic curves. If the fan is to be controlled by a frequency inverter without a sine filter, this must be stated when ordering. This requires a change of fan design and potential additional costs. Explosion proof fans are not controllable.

□ Electrical connection

Terminal box fitted externally on the casing as standard (IP 55).

□ Installation

Installation in any position. Ensure that motor drainage holes (where used) face downwards.

□ Motor protection

All models (3~ except ex proof) have thermal contacts as standard which must be connected to a full motor protection unit (see table below). With the 1 ph. ex-proof models thermal contacts are wired in series with the winding which automatically resets after cooling. Models without thermal contacts must be protected by a conventional circuit breaker.

□ Sound levels

Data shown within the performance curves refer to sound power levels. For determination of the lower sound pressure levels refer to diagram on “Technical information” page. Sound immission and acoustic information on page 10 on.

■ Information Page

Technical description	208
Selection chart	209
Design of systems	10 on

Made to order designs

Alternative voltages, frequencies, protection classes, acid protection, high temperatures etc. are available on request.

For safety and correct use note the technical information on page 15 on.

Type	Ref. no.	R.P.M.	Air flow volume (FID)	Motor power*	Voltage	Current*		Wiring diagram	Maximum air flow temp.		Nominal weight (net)	5 step transformer controller Pole switch		Full motor protection starter using the motor thermal contacts		Anti vibration mounts	
						standard supply	speed controlled		standard supply	speed controlled		Type	Ref. no.	Type	Ref. no.	comp	susp
			min ⁻¹	V m ³ /h	kW	V	A	A	No.	+°C	+°C	kg			Type	Type	
1 Phase motor, 1 ph. / 50 Hz, protection to IP 54																	
VARW 225/4	6660	1450	900	0.10	230	0.50	0.55	966	60	40	10.5	MWS 1 ¹⁾	1947	MW	1579	SDD 1	SDZ 1
VARW 225/2	6661	2770	1778	0.35	230	1.90	2.50	966	60	40	10.5	MWS 3 ¹⁾	1948	MW	1579	SDD 1	SDZ 1
3 Phase motor, 50 Hz, protection to IP 54																	
VARD 225/4	6662	1420	880	0.10	400Y	0.20	0.20	469	60	40	10.5	RDS 1 ^{1) 4)}	1314	MD	5849	SDD 1	SDZ 1
VARD 225/2	6663	2720	1750	0.28	400Y	0.60	0.60	469	60	40	10.5	RDS 1 ^{1) 4)}	1314	MD	5849	SDD 1	SDZ 1
													Pole switching, 2 speed motor (Dahlander windings Y/YY), 3 ph. / 50 Hz, protection to IP 54				
VARD 225/4/2	6771	1460/2800	880/1800	0.06/0.30	400	0.22/0.57	—	472	60	—	10.5	PDA 12 ³⁾	5081	M 3 ²⁾	1293	SDD 1	SDZ 1
Explosion proof, E Ex de II B, 1 ph. / 50 Hz, temperature class T1-T3, protection to IP 55																	
VARW 225/4 Ex	6733	1400	950	0.06	230	0.70	—	757	40	—	12.0	not permitted	—	—	SDD 1	SDZ 1	
VARW 225/2 Ex	6734	2650	1780	0.18	230	1.23	—	757	40	—	12.5	not permitted	—	—	SDD 1	SDZ 1	
Explosion proof, E Exe II, 3 ph. / 50 Hz, temperature class T1-T3, protected to IP 54																	
VARD 225/4 Ex	6664	1400	940	0.12	400	0.41	—	470	40	—	12.5	not permitted	not permitted	SDD 1	SDZ 1		
VARD 225/2 Ex	6665	2850	1930	0.25	400	0.72	—	470	40	—	12.5	not permitted	not permitted	SDD 1	SDZ 1		

* Ex models: For nominal value of motor see information on page 16 ¹⁾ includes full motor protection unit ²⁾ includes operation and speed switch ³⁾ see product page for flush mounted version ⁴⁾ Frequency inverter with integrated Sine filter, Type FU-BS 2,5, No. 5459, see product page FU.

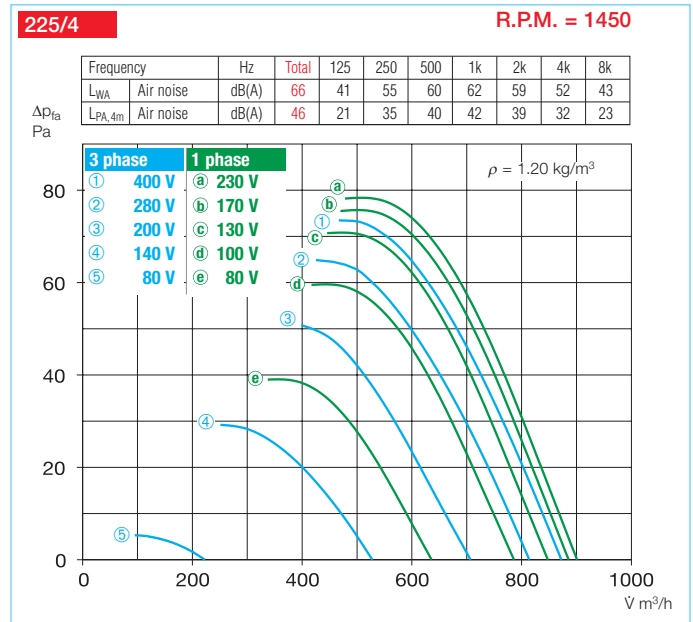
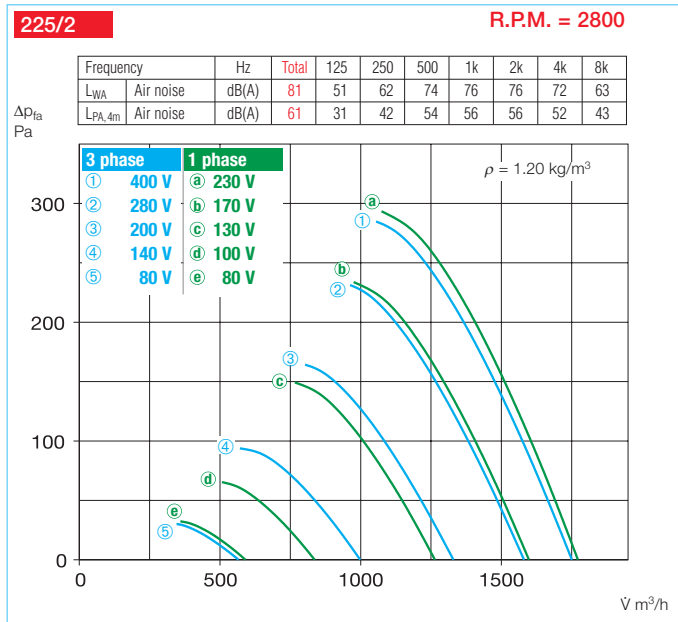

Other accessories	Page
b) Accessories for ex-proof fans	
Flanged flexible connector Type STS 225 Ex Ref. no. 2500	
Flexible sleeve Type FM 225 Ex Ref. no. 1687	
Attenuators	421 on
Shutters and grilles	487 on
Speed controllers and switches	525 on

Accessories Specification see page 231 on

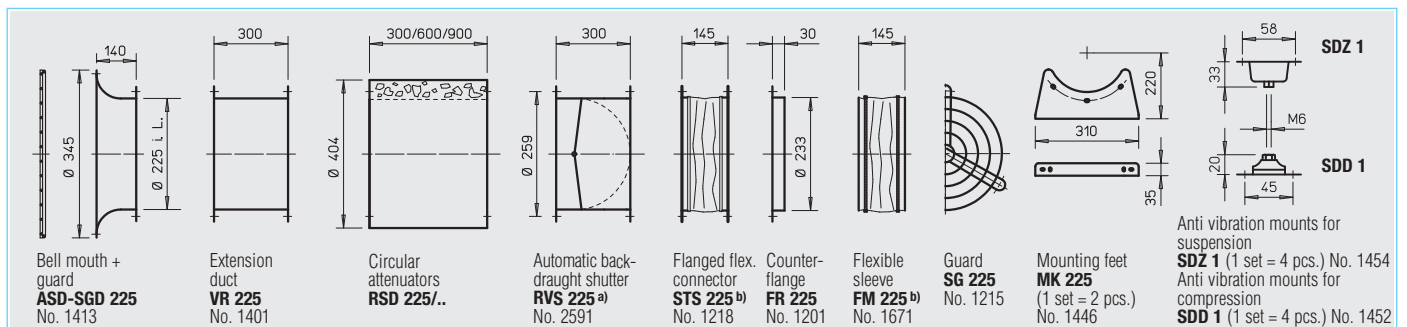

^{a)} For motorised shutters see accessory pages

^{b)} Types for explosion proof fans see above

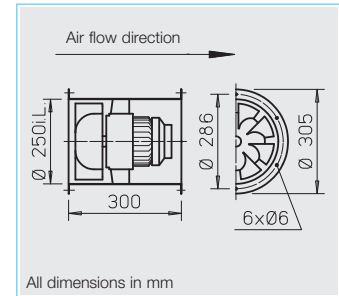

■ **Specification**

□ **Casing**

Manufactured in galvanised sheet steel with flanges on both sides to DIN 24155, Pt. 3, with fixed guide vanes and motor support.

□ **Impeller**

Optimised for high pressure and performance. Specially developed mixed-flow curved impeller manufactured from impact resistant polymers.

□ **Motor**

Direct driven, maintenance free flange motor, totally enclosed with an aluminium casing and cooling fins, protected to IP 54. Sealed for life ball bearings with tropicalized protection of windings and radio suppression. Optional drainage holes made to order (please state installation position).

□ **Speed control**

For all speed controllable models the current is given in the “speed controlled” column of the table below which must be used when selecting a controller (see controller column). The air flow volumes can be seen from the characteristic curves. If the fan is to be controlled by a frequency inverter without a sine filter, this must be stated when ordering. This requires a change of fan design and potential additional costs. Explosion proof fans are not controllable.

□ **Electrical connection**

Terminal box fitted externally on the casing as standard (IP 55).

□ **Installation**

Installation in any position. Ensure that motor drainage holes (where used) face downwards.

□ **Motor protection**

All models (3~ except ex proof) have thermal contacts as standard which must be connected to a full motor protection unit (see table below). With the 1 ph. ex-proof models thermal contacts are wired in series with the winding which automatically resets after cooling. Models without thermal contacts must be protected by a conventional circuit breaker.

□ **Sound levels**

Data shown within the performance curves refer to sound power levels. For determination of the lower sound pressure levels refer to diagram on “Technical information” page. Sound immission and acoustic information on page 10 on.

■ **Information** Page

Technical description	208
Selection chart	209
Design of systems	10 on

■ **Made to order designs**

Alternative voltages, frequencies, protection classes, acid protection, high temperatures etc. are available on request.

For safety and correct use note the technical information on page 15 on.

Type	Ref. no.	R.P.M.	Air flow volume (FID)	Motor power*	Voltage	Current*		Wiring diagram	Maximum air flow temp.		Weight net	5 step transformer controller Pole switch		Full motor protection starter using the motor thermal contacts		Anti vibration mounts	
						standard supply	speed controlled		standard supply	speed controlled		Type	Ref. no.	Type	Ref. no.	comp	susp
			min ⁻¹	∇ m ³ /h	kW	V	A	A	No.	+°C	+°C	kg			Type	Type	
1 Phase motor, 1 ph. / 50 Hz, protection to IP 54																	
VARW 250/4	6666	1420	1210	0.12	230	0.46	0.60	966	60	40	11.5	MWS 1,5 ¹⁾	1947	MW	1579	SDD 1	SDZ 1
VARW 250/2	6667	2840	2540	0.55	230	2.60	3.90	966	60	40	13.0	MWS 5 ¹⁾	1949	MW	1579	SDD 1	SDZ 1
3 Phase motor, 50 Hz, protection to IP 54																	
VARD 250/4	6668	1410	1250	0.09	400	0.30	0.30	469	60	40	11.5	RDS 1 ^{1) 4)}	1314	MD	5849	SDD 1	SDZ 1
VARD 250/2	6669	2800	2450	0.47	400	1.10	1.10	469	60	40	11.5	RDS 2 ^{1) 4)}	1315	MD	5849	SDD 1	SDZ 1
													Pole switching, 2 speed motor (Dahlander windings Y/YY), 3 ph. / 50 Hz, protection to IP 54				
VARD 250/4/2	6773	1425/2750	1200/2400	0.75/0.49	400	0.24/0.94	—	472	60	—	13.0	PDA 12 ³⁾	5081	M 3 ²⁾	1293	SDD 1	SDZ 1
Explosion proof, E Ex de II B, 1 ph. / 50 Hz, temperature class T1-T3, protection to IP 55																	
VARW 250/4 Ex	6735	1400	1290	0.06	230	0.70	—	757	40	—	13.0	not permitted	—	—	SDD 1	SDZ 1	
Explosion proof, E Exe II, 3 ph. / 50 Hz, temperature class T1-T3, protected to IP 54																	
VARD 250/4 Ex	6670	1400	1300	0.12	400	0.41	—	470	40	—	13.0	not permitted	not permitted	SDD 1	SDZ 1		
VARD 250/2 Ex	6671	2825	2590	0.37	400	0.95	—	470	40	—	15.5	not permitted	not permitted	SDD 1	SDZ 1		

* Ex models: For nominal value of motor see information on page 16 ¹⁾ includes full motor protection unit ²⁾ includes operation and speed switch ³⁾ see product page for flush mounted version

⁴⁾ Frequency inverter with integrated Sine filter, Type FU-BS 2.5, No. 5459, see product page FU.

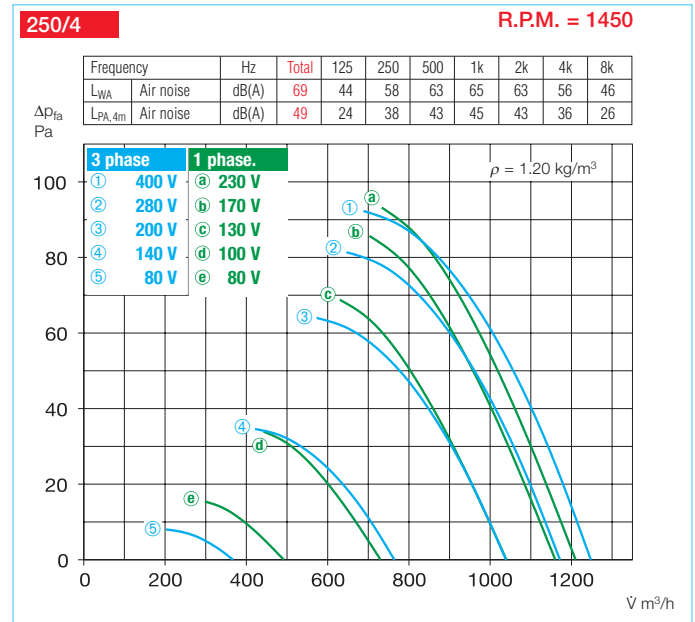
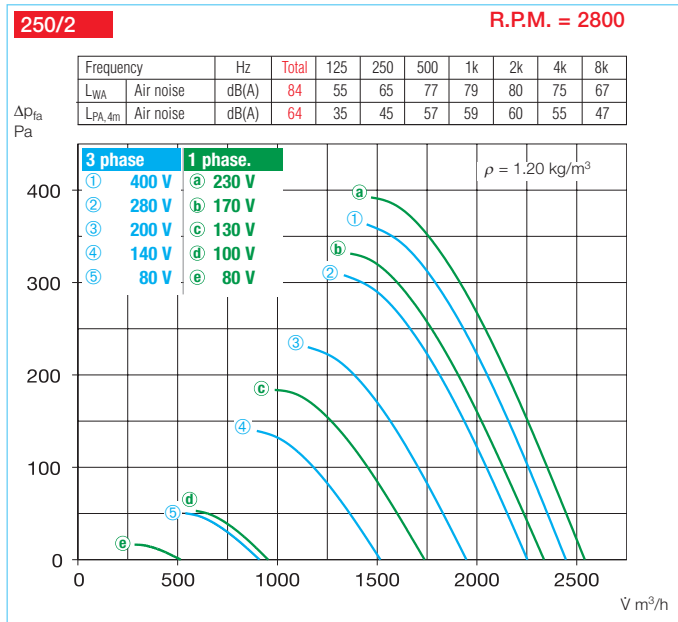

Other accessories	Page
b) Accessories for ex-proof fans	
Flanged flexible connector	
Type STS 250 Ex	Ref. no. 2501
Flexible sleeve	
Type FM 250 Ex	Ref. no. 1688
Attenuators	421 on
Shutters and grilles	487 on
Speed controllers and switches	525 on

Accessories Specification see page 231 on

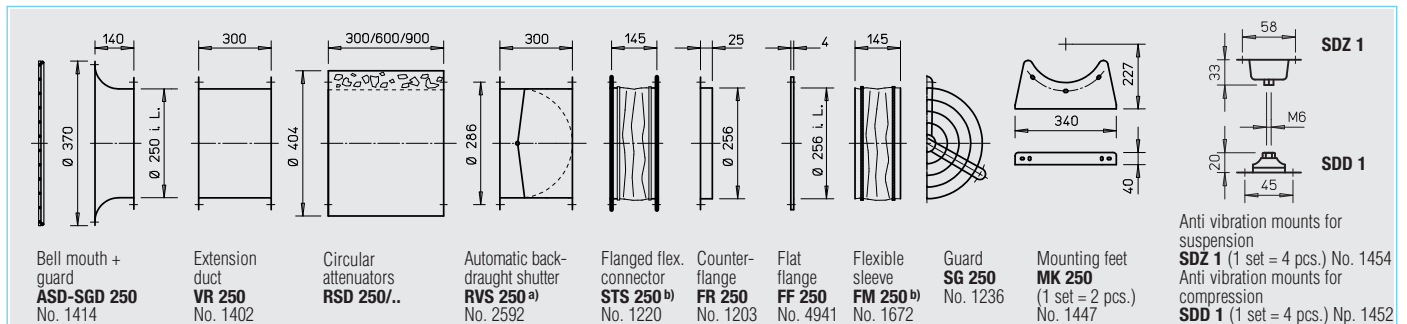

^{a)} For motorised shutters see accessory pages

^{b)} Types for explosion proof fans see above

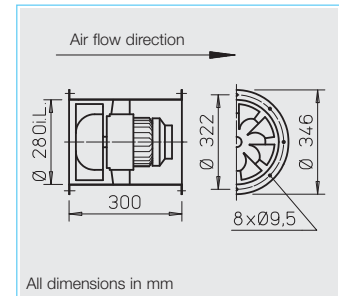

■ **Specification**

□ **Casing**

Manufactured in galvanised sheet steel with flanges on both sides to DIN 24155, Pt. 3, with fixed guide vanes and motor support.

□ **Impeller**

Optimised for high pressure and performance. Specially developed mixed-flow curved impeller manufactured from impact resistant polymers.

□ **Motor**

Direct driven, maintenance free flange motor, totally enclosed with an aluminium casing and cooling fins, protected to IP 54. Sealed for life ball bearings with tropicalized protection of windings and interference-free. Optional drainage holes made to order (please state installation position).

□ **Speed control**

For all speed controllable models the current is given in the “speed controlled” column of the table below which must be used when selecting a controller (see controller column). The air flow volumes can be seen from the characteristic curves. If the fan is to be controlled by a frequency inverter without a sine filter, this must be stated when ordering. This requires a change of fan design and potential additional costs. Explosion proof fans are not controllable.

□ **Electrical connection**

Terminal box fitted externally on the casing as standard (IP 55).

□ **Installation**

Installation in any position. Ensure that motor drainage holes (where used) face downwards.

□ **Motor protection**

All models (3~ except ex proof) have thermal contacts as standard which must be connected to a full motor protection unit (see table below). With the 1 ph. ex-proof models thermal contacts are wired in series with the winding which automatically resets after cooling. Models without thermal contacts must be protected by a conventional circuit breaker.

□ **Sound levels**

Data shown within the performance curves refer to sound power levels. For determination of the lower sound pressure levels refer to diagram on “Technical information” page. Sound emission and acoustic information on page 10 on.

■ **Information** Page

Technical description	208
Selection chart	209
Information for planning	10 on

■ **Made to order designs**

Alternative voltages, frequencies, protection classes, acid protection, high temperatures etc. are available on request.

For safety and correct use note the technical information on page 15 on.

Type	Ref. no.	R.P.M.	Air flow volume (FID)	Motor power*	Voltage	Current*		Wiring diagram	Maximum air flow temp.		Nominal weight (net)	5 step transformer controller Pole switch		Full motor protection starter using the motor thermal contacts		Anti vibration mounts		
						standard supply	speed controlled		standard supply	speed controlled		Type	Ref. no.	Type	Ref. no.	comp	susp	
			min ⁻¹	V m ³ /h	kW	V	A	A	No.	+°C	+°C	kg			Type	Ref. no.	Type	Type
1 Phase motor, 1 ph. / 50 Hz, protection to IP 54																		
VARW 280/4	6672	1330	1600	0.11	230	0.50	0.60	966	60	40	12.0	MWS 1,5 ¹⁾	1947	MW	1579	SDD 1	SDZ 1	
VARW 280/2	6659	2715	3350	0.79	230	3.70	4.90	967	60	40	14.0	MWS 7,5 ¹⁾	1950	MW	1579	SDD 1	SDZ 1	
3 Phase motor, 50 Hz, protection to IP 54																		
VARD 280/4	6673	1370	1650	0.12	400	0.35	0.35	469	60	40	12.0	RDS 1 ^{1) 4)}	1314	MD	5849	SDD 1	SDZ 1	
VARD 280/2	6674	2705	3315	0.80	400	1.52	1.64	469	60	40	13.5	RDS 2 ^{1) 4)}	1315	MD	5849	SDD 1	SDZ 1	
													Pole-switching, 2 speed motor (Dahlander windings Y/YY), 3 ph. / 50 Hz, protection to IP 54					
VARD 280/4/2	6775	1405/2810	1760/3500	0.14/0.91	400	0.44/1.78	—	472	60	—	16.0	PDA 12 ³⁾	5081	M 3 ²⁾	1293	SDD 1	SDZ 1	
Explosion proof, E Ex de II B, 1 ph. / 50 Hz, temperature class T1-T3, protection to IP 55																		
VARW 280/4 Ex	6737	1330	1720	0.18	230	1.25	—	757	40	—	14.0	not permitted	—	—	SDD 1	SDZ 1		
Explosion proof, E Exe II, 3 ph. / 50 Hz, temperature class T1-T3, protected to IP 54																		
VARD 280/4 Ex	6675	1400	1820	0.12	400	0.41	—	470	40	—	16.0	not permitted	not permitted	SDD 1	SDZ 1			
VARD 280/2 Ex	6676	1860	3720	0.75	400	1.65	—	470	40	—	18.0	not permitted	not permitted	SDD 1	SDZ 1			

* Ex models: For nominal value of motor see information on page 16

¹⁾ includes full motor protection unit

²⁾ includes operation and speed switch

³⁾ see product page for flush mounted version

⁴⁾ Frequency inverter with integrated Sine filter, Type FU-BS 2,5, No. 5459, see product page FU.

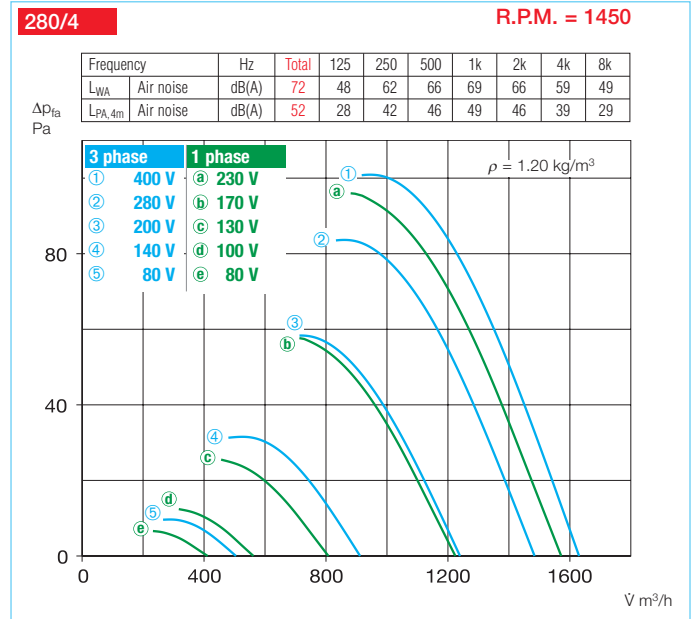
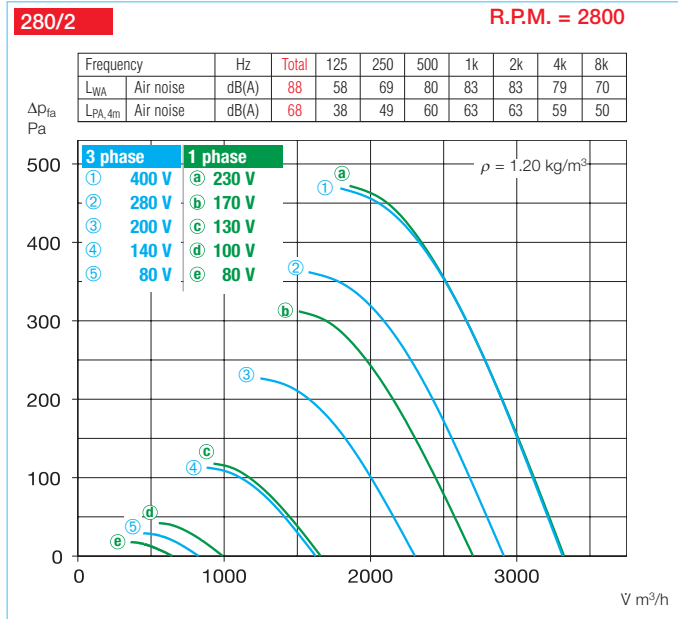

Other accessories	Page
b) Accessories for ex-proof fans	
Flanged flexible connector	
Type STS 280 Ex	Ref. no. 2502
Flexible sleeve	
Type FM 280 Ex	Ref. no. 1689
Attenuators	421 on
Shutters and grilles	487 on
Speed controllers and switches	525 on

Accessories Specification see page 231 on

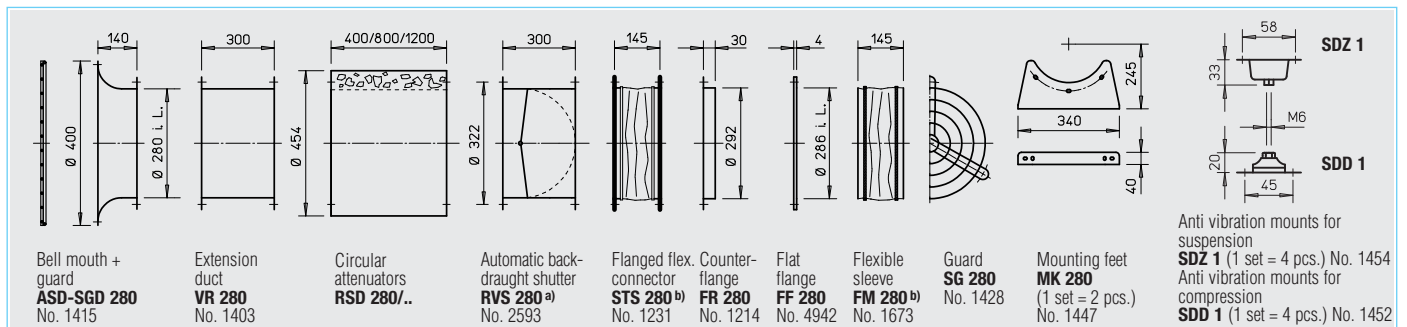

^{a)} For motorised shutters see accessory pages

^{b)} Types for explosion proof fans see above

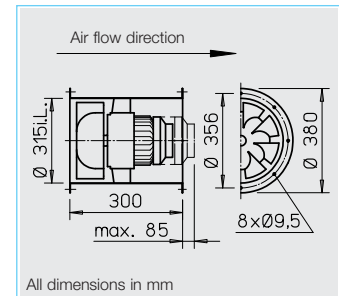

■ Specification

□ Casing

Manufactured in galvanised sheet steel with flanges on both sides to DIN 24155, Pt. 3, with fixed guide vanes and motor support.

□ Impeller

Optimised for high pressure and performance. Specially developed mixed-flow curved impeller manufactured from impact resistant polymers.

□ Motor

Direct driven, maintenance free flange motor, totally enclosed with an aluminium casing and cooling fins, protected to IP 54. Sealed for life ball bearings with tropicalized protection of windings and interference-free. Optional drainage holes made to order (please state installation position).

□ Speed control

For all speed controllable models the current is given in the “speed controlled” column of the table below which must be used when selecting a controller (see controller column). The air flow volumes can be seen from the characteristic curves. If the fan is to be controlled by a frequency inverter without a sine filter, this must be stated when ordering. This requires a change of fan design and potential additional costs. Explosion proof fans are not controllable.

□ Electrical connection

Terminal box fitted externally on the casing as standard (IP 55).

□ Installation

Installation in any position. Ensure that motor drainage holes (where used) face downwards.

□ Motor protection

All models (3~ except ex proof) have thermal contacts as standard which must be connected to a full motor protection unit (see table below). With the 1 ph. ex-proof models thermal contacts are wired in series with the winding which automatically resets after cooling. Models without thermal contacts must be protected by a conventional circuit breaker.

□ Sound levels

Data shown within the performance curves refer to sound power levels. For determination of the lower sound pressure levels refer to diagram on “Technical information” page. Sound emission and acoustic information on page 10 on.

■ Information Page

Technical description	208
Selection chart	209
Information for planning	10 on

Made to order designs

Alternative voltages, frequencies, protection classes, acid protection, high temperatures etc. are available on request.

For safety and correct use note the technical information on page 15 on.

Type	Ref. no.	R.P.M.	Air flow volume (FID)	Motor power*	Voltage	Current*		Wiring diagram	Maximum air flow temp.		Nominal weight (net)	5 step transformer controller Pole switch		Full motor protection starter using the motor thermal contacts		Anti vibration mounts		
						standard supply	speed controlled		standard supply	speed controlled		Type	Ref. no.	Type	Ref. no.	comp	susp	
			min ⁻¹	∇ m ³ /h	kW	V	A	A	No.	+°C	+°C	kg					Type	Type
1 Phase motor, 1 ph. / 50 Hz, protection to IP 54																		
VARW 315/4	6677	1440	2480	0.23	230	1.10	1.17	966	60	40	13.0	MWS 3 ¹⁾	1948	MW	1579	SDD 1	SDZ 1	
3 Phase motor, 50 Hz, protection to IP 54																		
VARD 315/4	6678	1450	2510	0.22	400	0.60	0.70	469	60	40	13.0	RDS 1 ^{1) 4)}	1314	MD	5849	SDD 1	SDZ 1	
Two-speed, 3 ph., 50 Hz, Y/Δ switch, protection to IP 54																		
VARD 315/2/2	6679	1520/2650	2921/4670	1.29/1.35	400Y/Δ	1.5/2.75	2.8	520	60	40	20.5	RDS 4 ¹⁾	1316	M 4 ²⁾	1571	SDD 1	SDZ 1	
													Pole-switching, 2 speed motor (Dahlander windings Y/YY), 3 ph. / 50 Hz, protection to IP 54					
VARD 315/4/2	6777	1480/2890	2730/5340	0.42/1.83	400	1.2/3.3	—	472	60	—	20.5	PDA 12 ³⁾	5081	M 3 ²⁾	1293	SDD 1	SDZ 1	
Explosion proof, E Ex de II B, 1 ph. / 50 Hz, temperature class T1-T3, protection to IP 55																		
VARW 315/4 Ex	6738	1450	2680	0.18	230	1.25	—	757	40	—	15.0	not permitted	—	—	SDD 1	SDZ 1		
Explosion proof, E Exe II, 3 ph. / 50 Hz, temperature class T1-T3, protected to IP 54																		
VARD 315/4 Ex	6680	1420	2610	0.37	400	1.14	—	470	40	—	17.0	not permitted	not permitted	SDD 1	SDZ 1			
VARD 315/2 Ex	6681	2860	5260	1.50	400	3.15	—	470	40	—	23.0	not permitted	not permitted	SDD 1	SDZ 1			

* Ex models: For nominal value of motor see information on page 16 ¹⁾ includes full motor protection unit ²⁾ includes operation and speed switch ³⁾ see product page for flush mounted version

⁴⁾ Frequency inverter with integrated Sine filter, Type FU-BS 2.5, No. 5459, see product page FU.

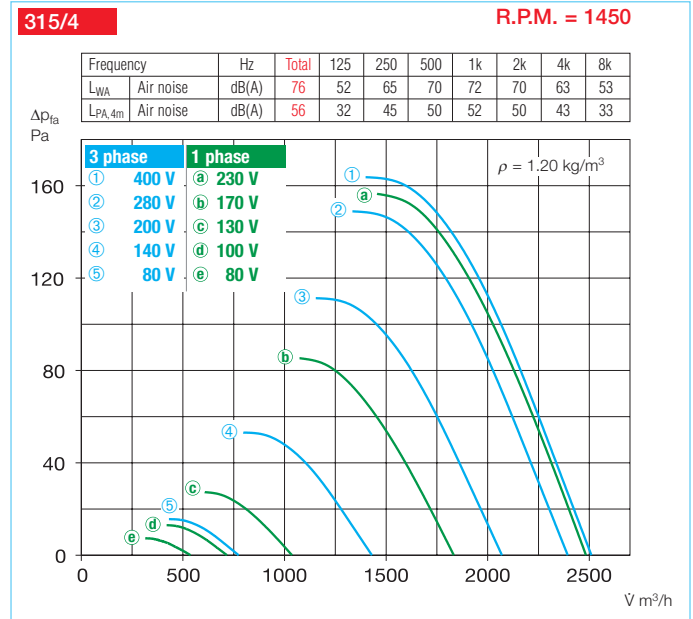
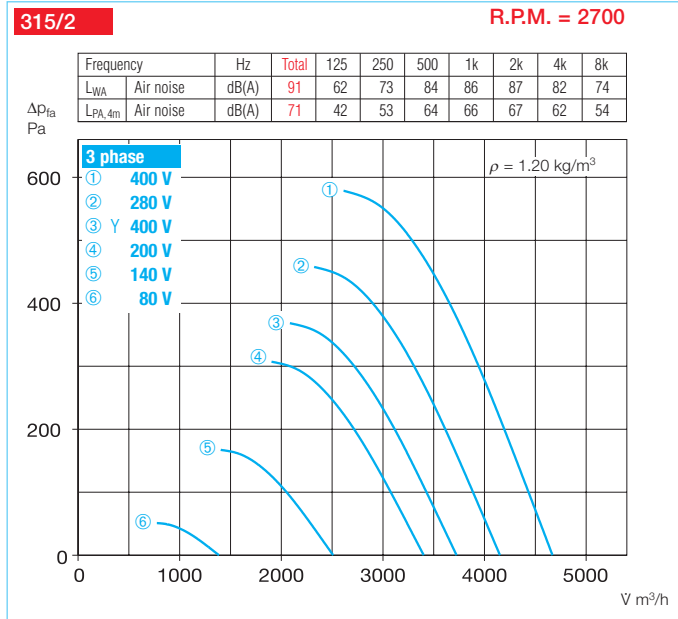

Other accessories	Page
b) Accessories for ex-proof fans	
Flanged flexible connector	
Type STS 315 Ex	Ref. no. 2503
Flexible sleeve	
Type FM 315 Ex	Ref. no. 1690
Attenuators	421 on
Shutters and grilles	487 on
Speed controllers and switches	525 on

Accessories Specification see page 231 on

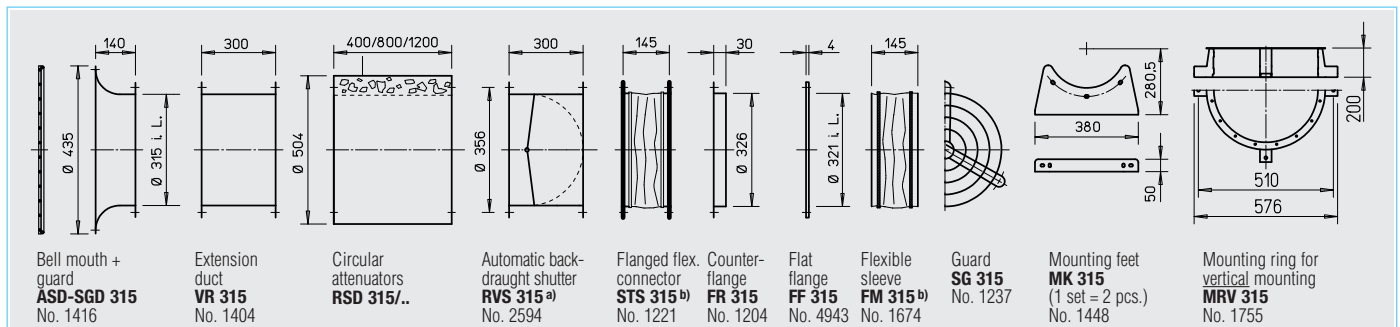

a) For motorised shutters see accessory pages

b) Types for explosion proof fans see above

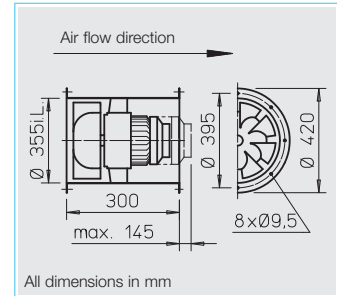

■ Specification

□ Casing

Manufactured in galvanised sheet steel with flanges on both sides to DIN 24155, Pt. 3, with fixed guide vanes and motor support.

□ Impeller

Optimised for high pressure and performance. Specially developed mixed-flow curved impeller manufactured from impact resistant polymers (models with R.P.M. = 2800 from hot dipped galvanised steel).

□ Motor

Direct driven, maintenance free flange motor, totally enclosed with an aluminium casing and cooling fins, protected to IP 54. Sealed for life ball bearings with tropicalized protection of windings and interference-free. Optional drainage holes made to order (please state installation position).

□ Speed control

For all speed controllable models the current is given in the “speed controlled” column of the table below which must be used when selecting a controller (see controller column). The air flow volumes can be seen from the characteristic curves. If the fan is to be controlled by a frequency inverter without a sine filter, this must be stated when ordering. This requires a change of fan design and potential additional costs. Explosion proof fans are not controllable.

□ Electrical connection

Terminal box fitted externally on the casing as standard (IP 55).

□ Installation

Installation in any position. Ensure that motor drainage holes (where used) face downwards.

□ Motor protection

All models (excluding ex-proof models and model VARD 355/4/2) have thermal contacts as standard which must be connected to a full motor protection unit (see table below) for effective motor protection. Models without thermal contacts must be protected by a conventional circuit breaker.

□ Sound levels

Data shown within the performance curves refer to sound power levels. For determination of the lower sound pressure levels refer to diagram on “Technical information” page. Sound emission and acoustic information on page 10 on.

■ Information Page

Technical description	208
Selection chart	209
Information for planning	10 on

Made to order designs

Alternative voltages, frequencies, protection classes, acid protection, high temperatures etc. are available on request.

For safety and correct use note the technical information on page 15 on.

Type	Ref. no.	R.P.M.	Air flow volume (FID)	Motor power*	Voltage	Current*		Wiring diagram	Maximum air flow temp. standard supply	speed controlled	Nominal weight (net)	5 step transformer controller Pole switch		Full motor protection starter using the motor thermal contacts		Anti vibration mounts	
						standard supply	speed controlled					Type	Ref. no.	Type	Ref. no.	comp	susp
			min ⁻¹	V m ³ /h	kW	V	A	A	No.	+°C	+°C	kg			Type	Type	
1 Phase motor, 1 ph. / 50 Hz, protection to IP 54																	
VARW 355/4	6682	1380	3470	0.37	230	3.30	2.35	966	60	40	21.0	MWS 3 ¹⁾	1948	MW	1579	SDD 1	SDZ 1
3 Phase motor, 50 Hz, protection to IP 54																	
VARD 355/4	6683	1440	3550	0.40	400	0.87	1.20	469	60	40	15.5	RDS 1 ^{1) 5)}	1314	MD	5849	SDD 1	SDZ 1
Two-speed, 3 ph., 50 Hz, Y/Δ switch, protection to IP 54																	
VARD 355/2/2	6684	2415/2790	6040/7220	2.06/2.81	400Y/Δ	3.40/5.40	—	520	60	30	21.5	RDS 7 ¹⁾	1578	M 4 ²⁾	1571	SDD 1	SDZ 1
												Pole switching, 2 speed motor (Dahlander windings Y/YY), 3 ph. / 50 Hz, protection to IP 54					
VARD 355/4/2	6779	1470/2870	3830/7500	0.48/3.11	400	1.35/5.50	—	471	40	—	29.0	PDA 12 ³⁾	5081	M 3 ²⁾	1293	SDD 1	SDZ 1
Explosion proof, E Exe II, 3 ph. / 50 Hz, temperature class T1-T3, protected to IP 54																	
VARD 355/4 Ex	6685	1420	3740	0.37	400	1.14	—	470	40	—	19.0	not permitted	not permitted	SDD 1	SDZ 1		
VARD 355/2 Ex ⁴⁾	6686	2860	7580	2.50	400	4.85/2.77	—	498	40	—	33.0	not permitted	not permitted	SDD 1	SDZ 1		

* Ex models: For nominal value of motor see information on page 16 ¹⁾ includes full motor protection unit ²⁾ includes operation and speed switch ³⁾ see product page for flush mounted version

⁴⁾ Vibration monitoring is necessary (on site) pursuant to DIN EN 14986. ⁵⁾ Frequency inverter with integrated Sine filter, Type FU-BS 2,5, No. 5459, see product page FU.

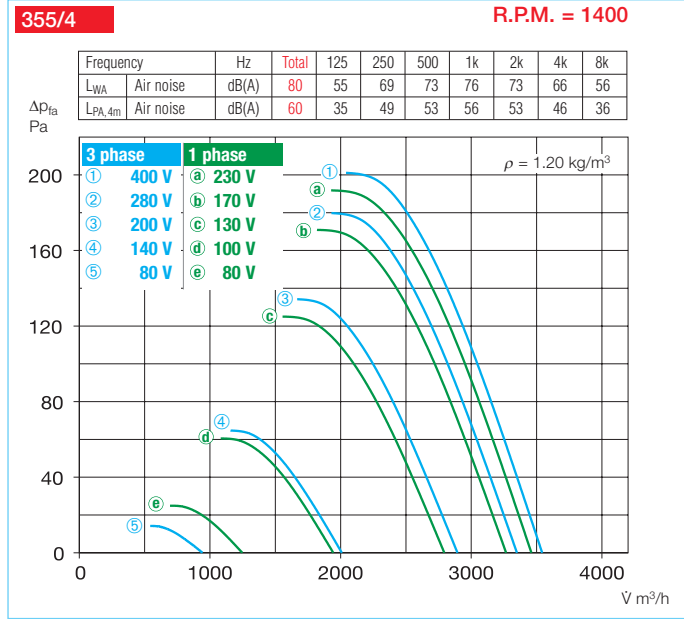
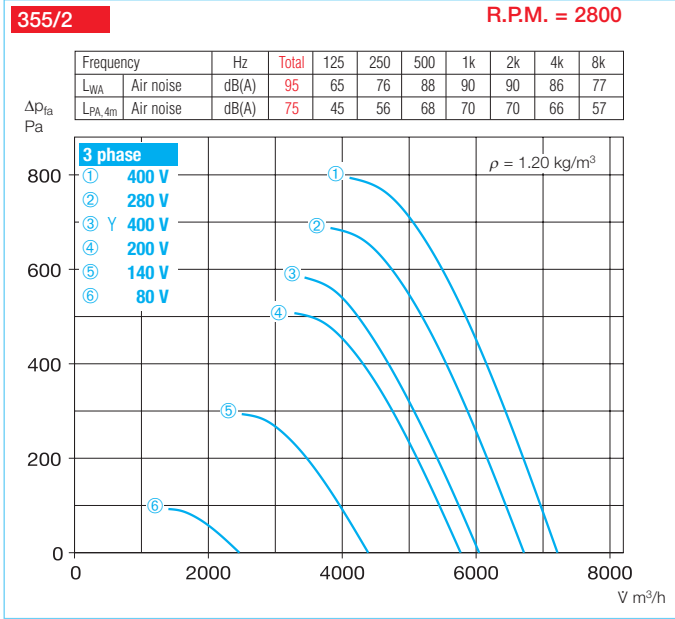

Other accessories	Page
b) Accessories for ex-proof fans	
Flanged flexible connector	
Type STS 355 Ex	Ref. no. 2504
Flexible sleeve	
Type FM 355 Ex	Ref. no. 1691
Attenuators	421 on
Shutters and grilles	487 on
Speed controllers and switches	525 on

Accessories Specification see page 231 on

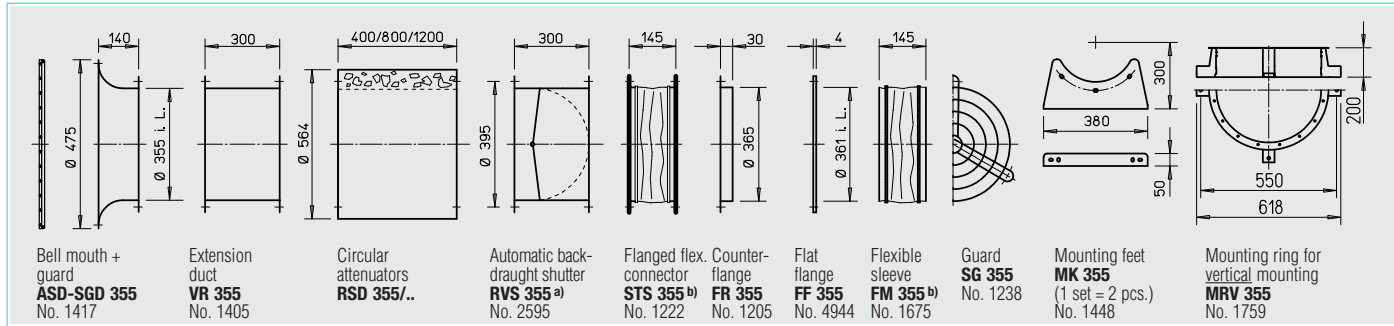

a) For motorised shutters see accessory pages

b) Types for explosion proof fans see above

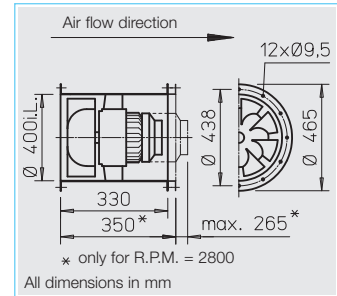

■ Specification

□ Casing

Manufactured in galvanised steel with flanges on both sides to DIN 24155, Pt. 3, vanes and fixed motor support. Models with R.P.M. = 2800 with welded casing made from hot dipped galvanised steel.

□ Impeller

Optimised for high pressure and performance. Specially developed mixed-flow curved impeller manufactured from hot dipped galvanised steel.

□ Motor

Direct driven, maintenance free flange motor, totally enclosed with an aluminium casing and cooling fins, protected to IP 54. Sealed for life ball bearings with tropicalized protection of windings and interference-free. Optional drainage holes made to order (please state installation position).

□ Speed control

For all speed controllable models the current is given in the “speed controlled” column of the table below which must be used when selecting a controller (see controller column). The air flow volumes can be seen from the characteristic curves. If the fan is to be controlled by a frequency inverter without a sine filter, this must be stated when ordering. This requires a change of fan design and potential additional costs. Explosion proof fans are not controllable.

□ Electrical connection

Terminal box fitted externally on the casing as standard (IP 55).

□ Installation

Installation in any position. Ensure that motor drainage holes (where used) face downwards.

□ Motor protection

All models (excluding ex-proof models and model VARD 400/4/2) have thermal contacts as standard which must be connected to a full motor protection unit (see table below) for effective motor protection. Models without thermal contacts must be protected by a conventional circuit breaker.

□ Sound levels

Data shown within the performance curves refer to sound power levels. For determination of the lower sound pressure levels refer to diagram on “Technical information” page. Sound emission and acoustic information on page 10 on.

■ Information Page

Technical description	208
Selection chart	209
Information for planning	10 on

Made to order designs

Alternative voltages, frequencies, protection classes, acid protection, high temperatures etc. are available on request.

For safety and correct use note the technical information on page 15 on.

Type	Ref. no.	R.P.M.	Air flow volume (FID)	Motor power*	Voltage	Current*		Wiring diagram	Maximum air flow temp.		Nominal weight (net)	5 step transformer controller Pole switch		Full motor protection starter using the motor thermal contacts		Anti vibration mounts	
						standard supply	speed controlled		standard supply	speed controlled		Type	Ref. no.	Type	Ref. no.	comp	susp
		min ⁻¹	V m ³ /h	kW	V	A	A	No.	+°C	+°C	kg	Type	Ref. no.	Type	Ref. no.	Type	Type
1 Phase motor, 1 ph. / 50 Hz, protection to IP 54																	
VARW 400/4	6688	1375	5130	0.70	230	3.00	3.35	967	60	40	22.5	MWS 5 ¹⁾	1949	MW	1579	SDD 1	SDZ 1
3 Phase motor, 50 Hz, protection to IP 54																	
VARD 400/4	6690	1400	5240	0.72	400	1.95	2.00	469	60	40	22.5	RDS 4 ^{1) 5)}	1316	MD	5849	SDD 1	SDZ 1
Two-speed, 3 ph., 50 Hz, Y/Δ switch, protection to IP 54																	
VARD 400/2/2	6691	2475/2800	8320/10610	3.63/4.95	400Y/Δ	5.75/7.95	—	520	60	40	74.0	RDS 11 ¹⁾	1332	M 4 ²⁾	1571	SDD 1	SDZ 2
												Pole switch					
Pole-switching, 2 speed motor (Dahlander windings Y/YY), 3 ph. / 50 Hz, protection to IP 54																	
VARD 400/4/2	6782	1400/2890	5220/10700	0.80/5.90	400	2.43/9.13	—	471	40	—	74.0	PDA 12 ³⁾	5081	M 3 ²⁾	1293	SDD 1	SDZ 2
Explosion proof, E Exe II, 3 ph. / 50 Hz, temperature class T1-T3, protected to IP 54																	
VARD 400/6 Ex	6692	920	3465	0.25	400	0.97	—	470	40	—	21.0	not permitted	not permitted	SDD 1	SDZ 1		
VARD 400/4 Ex	6693	1400	5360	0.55	400	1.51	—	470	40	—	25.0	not permitted	not permitted	SDD 1	SDZ 1		
VARD 400/2 Ex ⁴⁾	6694	2895	10950	4.60	400	8.20	—	498	40	—	83.0	not permitted	not permitted	SDD 2	SDZ 2		

* Ex models: For nominal value of motor see information on page 16 ¹⁾ includes full motor protection unit ²⁾ includes operation and speed switch ³⁾ see product page for flush mounted version

⁴⁾ Vibration monitoring is necessary (on site) pursuant to DIN EN 14986. ⁵⁾ Frequency inverter with integrated Sine filter, Type FU-BS 2.5, No. 5459, see product page FU.

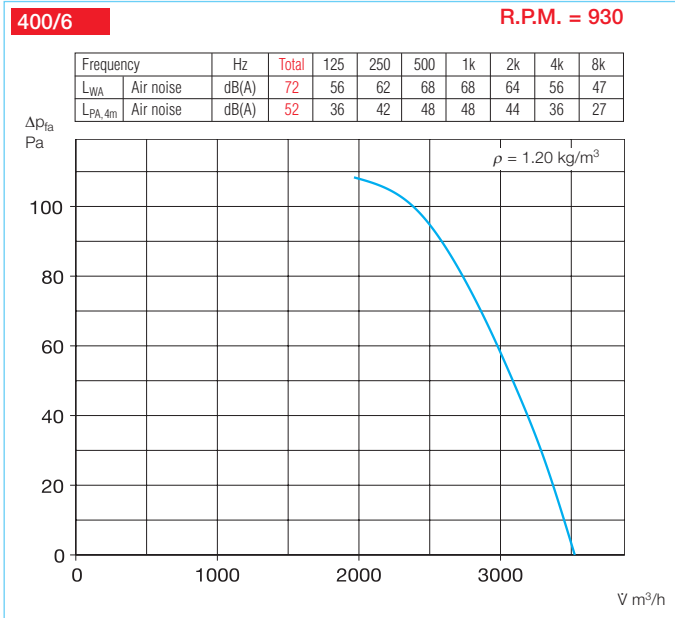
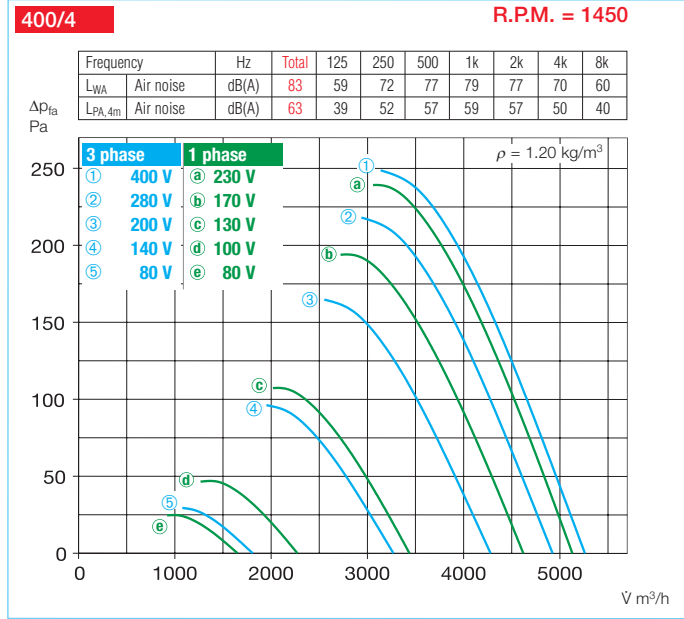
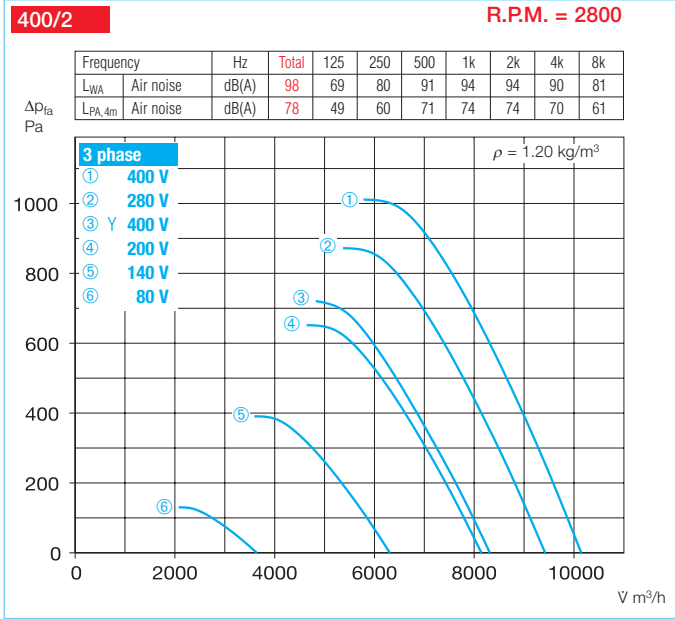

Other accessories	Page
Accessories for ex-proof fans	
Flanged flexible connector Type STS 400 Ex	Ref. no. 2505
Flexible sleeve Type FM 400 Ex	Ref. no. 1692
Attenuators	421 on
Shutters and grilles	487 on
Speed controllers and switches	525 on

Accessories Specification see page 231 on

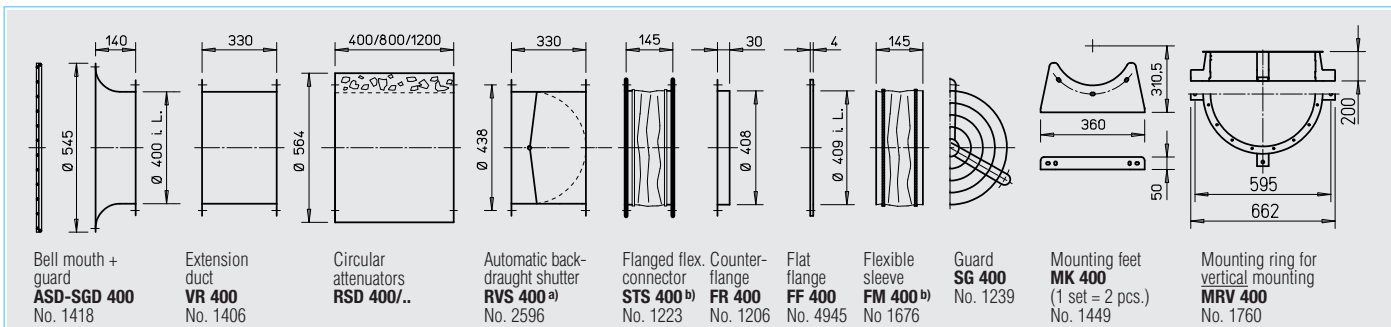

^{a)} For motorised shutters see accessory pages

^{b)} Types for explosion proof fans see left page

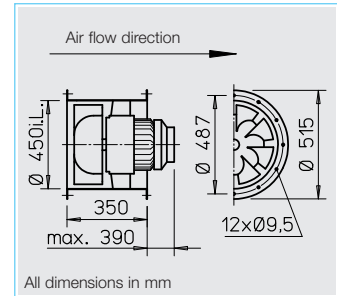

■ **Specification**

□ **Casing**

Manufactured in galvanised steel with flanges on both sides to DIN 24155, Pt. 3, vanes and fixed motor support. Models with R.P.M. = 2800 with welded casing made from hot dipped galvanised steel.

□ **Impeller**

Optimised for high pressure and performance. Specially developed mixed-flow curved impeller manufactured from hot dipped galvanised steel.

□ **Motor**

Direct driven, maintenance free flange motor, totally enclosed with an aluminium casing and cooling fins, protected to IP 54. Sealed for life ball bearings with tropicalized protection of windings and interference-free. Optional drainage holes made to order (please state installation position).

□ **Speed control**

For all speed controllable models the current is given in the “speed controlled” column of the table below which must be used when selecting a controller (see controller column). The air flow volumes can be seen from the characteristic curves. If the fan is to be controlled by a frequency inverter without a sine filter, this must be stated when ordering. This requires a change of fan design and potential additional costs. Explosion proof fans are not controllable.

□ **Electrical connection**

Terminal box fitted externally on the casing as standard (IP 55).

□ **Installation**

Installation in any position. Ensure that motor drainage holes (where used) face downwards.

□ **Motor protection**

All models (excluding ex-proof models) have thermal contacts and PTC Thermistors as standard which must be connected to a full motor protection unit (see table below) for effective motor protection. Models without thermal contacts must be protected by a conventional circuit breaker.

□ **Sound levels**

Data shown within the performance curves refer to sound power levels. For determination of the lower sound pressure levels refer to diagram on “Technical information” page. Sound emission and acoustic information on page 10 on.

■ **Information** Page

Technical description	208
Selection chart	209
Information for planning	10 on

■ **Made to order designs**

Alternative voltages, frequencies, protection classes, acid protection, high temperatures etc. are available on request.

For safety and correct use note the technical information on page 15 on.

Type	Ref. no.	R.P.M.	Air flow volume (FID)	Motor power*	Voltage	Current*		Wiring diagram	Maximum air flow temp.		Nominal weight (net)	5 step transformer controller Pole switch		Full motor protection starter using the motor thermal contacts		Anti vibration mounts	
						standard supply	speed controlled		standard supply	speed controlled		Type	Ref. no.	Type	Ref. no.	comp	susp
			min ⁻¹	V m ³ /h	V	A	A	No.	+°C	+°C	kg	Type	Ref. no.	Type	Ref. no.	Type	Type
1 Phase motor, 1 ph. / 50 Hz, protection to IP 54																	
VARW 450/4	6736	1330	7180	1.47	230	6.50	7.00	968	60	40	45.0	MWS 7,5¹⁾	1950	MW	1579	SDD 1	SDZ 1
3 Phase motor, 50 Hz, protection to IP 54																	
VARD 450/2	6698	2950	14210	8.03	400	13.8	—	776	60	—	95.0	FU-CS18¹⁾⁵⁾	5469	MSA³⁾	1289	SDD 2	SDZ 2
Two-speed, 3 ph., 50 Hz, Y/Δ switch, protection to IP 54																	
VARD 450/4 Ex	6697	1100/1370	5930/7390	0.74/1.00	400Y/Δ	1.2/2.3	2.3	520	60	40	45.0	RDS 4¹⁾	1316	M 4²⁾	1571	SDD 1	SDZ 1
Explosion proof, E Exe II, 3 ph. / 50 Hz, temperature class T1-T3, protected to IP 54																	
VARD 450/6 Ex	6699	900	5020	0.25	400	0.99	—	470	40	—	48.0	not permitted	not permitted			SDD 1	SDZ 1
VARD 450/4 Ex	6700	1425	7640	1.10	400	2.55	—	470	40	—	51.0	not permitted	not permitted			SDD 1	SDZ 1
VARD 450/2 Ex⁴⁾	6701	2930	15810	7.50	400	14.10	—	498	40	—	155.0	not permitted	not permitted			SDD 2	SDZ 2

* Ex models: For nominal value of motor see information on page 16 ¹⁾ includes full motor protection unit ²⁾ includes operation and speed switch ³⁾ for PTC Thermistor temp. sensor

⁴⁾ Vibration monitoring is necessary (on site) pursuant to DIN EN 14986. ⁵⁾ with integrated Sine filter, see product page FU

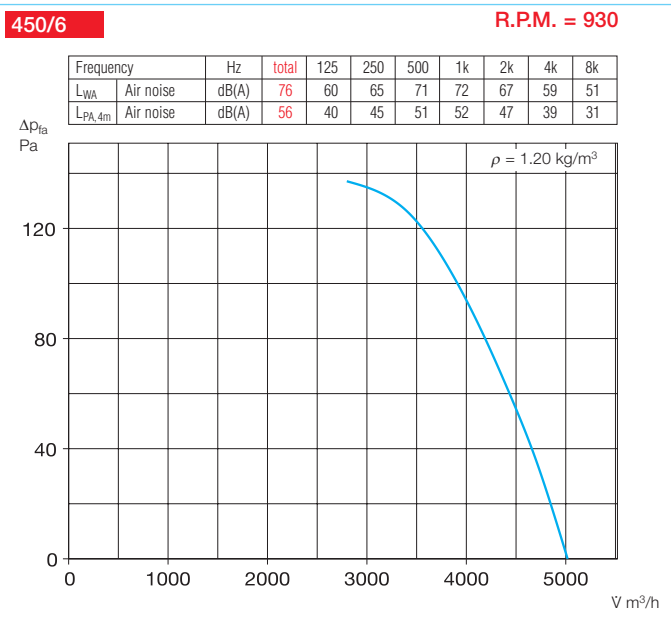
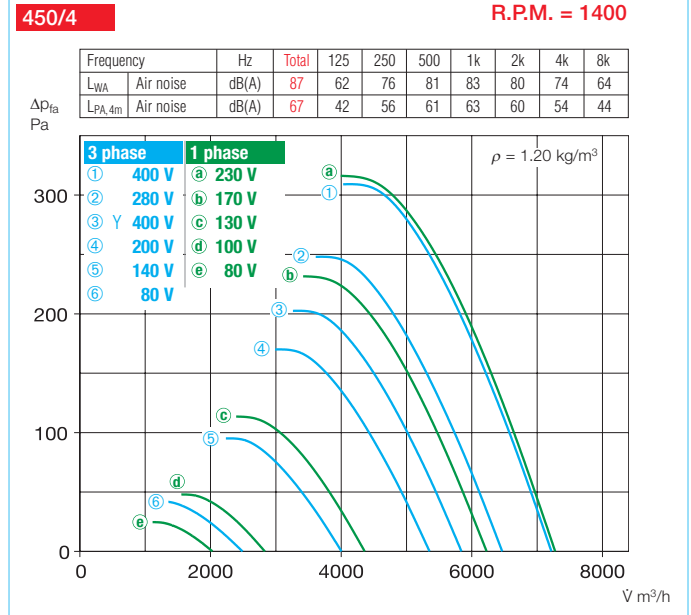
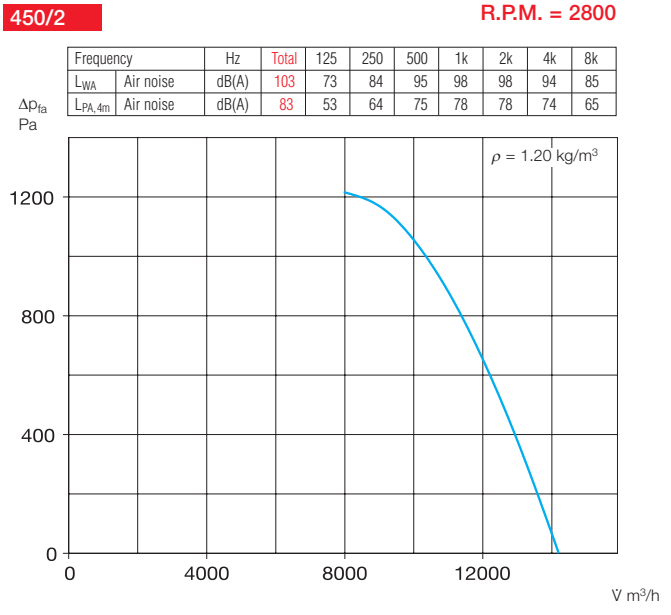

Other accessories	Page
Accessories for ex-proof fans	
Flanged flexible connector Type STS 450 Ex Ref. no. 2506	
Flexible sleeve Type FM 450 Ex Ref. no. 1693	
Attenuators	421 on
Shutters and grilles	487 on
Speed controllers and switches	525 on

Accessories Specification see page 231 on

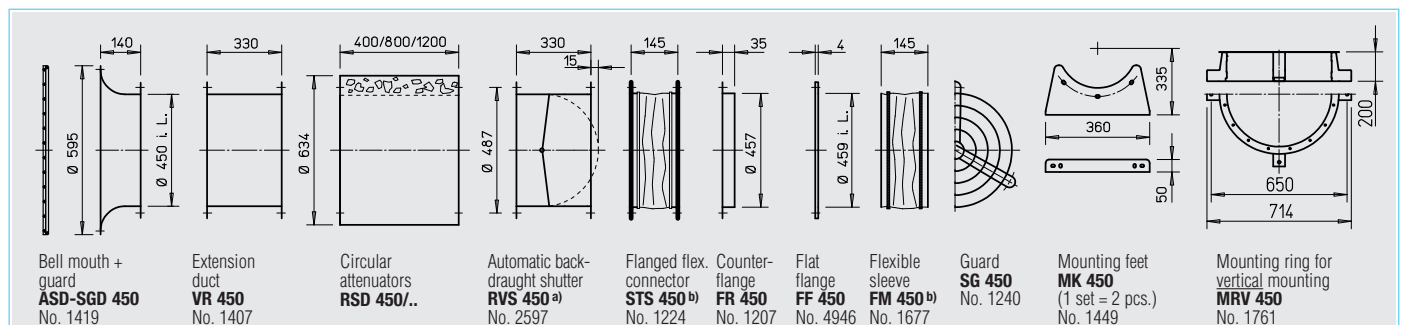

a) For motorised shutters see accessory pages

b) Types for explosion proof fans see left page

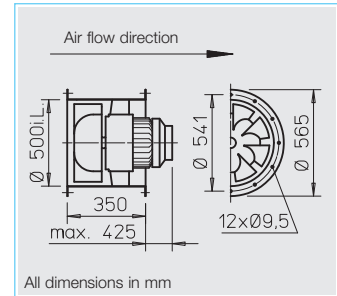

■ Specification

□ Casing

Manufactured in galvanised steel with flanges on both sides to DIN 24155, Pt. 3, vanes and fixed motor support. Models with R.P.M. = 2800 with welded casing made from hot dipped galvanised steel.

□ Impeller

Optimised for high pressure and performance. Specially developed mixed-flow curved impeller manufactured from hot dipped galvanised steel.

□ Motor

Direct driven, maintenance free flange motor, totally enclosed with an aluminium casing and cooling fins, protected to IP 54. Sealed for life ball bearings with tropicalized protection of windings and interference-free. Optional drainage holes made to order (please state installation position).

□ Speed control

For all speed controllable models the current is given in the “speed controlled” column of the table below which must be used when selecting a controller (see controller column). The air flow volumes can be seen from the characteristic curves. If the fan is to be controlled by a frequency inverter without a sine filter, this must be stated when ordering. This requires a change of fan design and potential additional costs. Explosion proof fans are not controllable.

□ Electrical connection

Terminal box fitted externally on the casing as standard (IP 55).

□ Installation

Installation in any position. Ensure that motor drainage holes (where used) face downwards.

□ Motor protection

All models (excluding ex-proof models) have thermal contacts and PTC Thermistors as standard which must be connected to a full motor protection unit (see table below) for effective motor protection. Models without thermal contacts must be protected by a conventional circuit breaker.

□ Sound levels

Data shown within the performance curves refer to sound power levels. For determination of the lower sound pressure levels refer to diagram on “Technical information” page. Sound emission and acoustic information on page 10 on.

■ Information Page

Technical description	208
Selection chart	209
Information for planning	10 on

Made to order designs

Alternative voltages, frequencies, protection classes, acid protection, high temperatures etc. are available on request.

For safety and correct use note the technical information on page 15 on.

Type	Ref. no.	R.P.M.	Air flow volume (FID)	Motor power*	Voltage	Current*		Wiring diagram	Maximum air flow temp.		Nominal weight (net)	5 step transformer controller Pole switch		Full motor protection starter using the motor thermal contacts		Anti vibration mounts	
		min ⁻¹				V	A		A	No.		+°C	+°C	kg	Type	Ref. no.	Type
1 Phase motor, 1 ph. / 50 Hz, protection to IP 54																	
VARW 500/4	6739	1340	9920	2.02	230	9.10	9.10	968	60	40	70.0	MWS 10¹⁾	1946	MW	1579	SDD 2	SDZ 2
3 Phase motor, 50 Hz, protection to IP 54																	
VARD 500/2	6705	2935	21730	15.70	400	29/16.7	—	776	60	—	180.0	FU-CS32¹⁾⁵⁾	5471	MSA³⁾	1289	SDD 2	SDZ 3
Two-speed, 3 ph., 50 Hz, Y/Δ switch, protection to IP 54																	
VARD 500/4/4	6704	1120/1370	8360/10070	1.2/1.8	400Y/Δ	2.1/3.9	3.9	520	60	40	70.0	RDS 7¹⁾	1578	M 4²⁾	1571	SDD 2	SDZ 2
Explosion proof, E Exe II, 3 ph. / 50 Hz, temperature class T1-T3, protected to IP 54																	
VARD 500/6 Ex	6706	930	6810	0.55	400	1.83	—	470	40	—	70.0	not permitted		not permitted		SDD 2	SDZ 2
VARD 500/4 Ex	6707	1420	10470	2.00	400	4.65	—	470	40	—	75.0	not permitted		not permitted		SDD 2	SDZ 2
VARD 500/2 Ex⁴⁾	6708	2930	21760	12.50	400	23.50	—	498	40	—	215.0	not permitted		not permitted		SDD 3	SDZ 3

* Ex models: For nominal value of motor see information on page 16 ¹⁾ includes full motor protection unit ²⁾ includes operation and speed switch ³⁾ for PTC Thermistor temp. sensor
⁴⁾ Vibration monitoring is necessary (on site) pursuant to DIN EN 14986. ⁵⁾ with integrated Sine filter, see product page FU

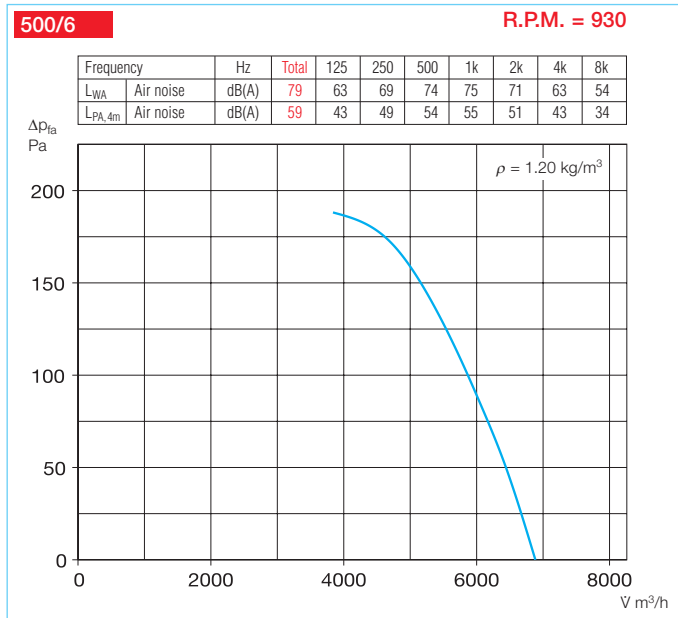
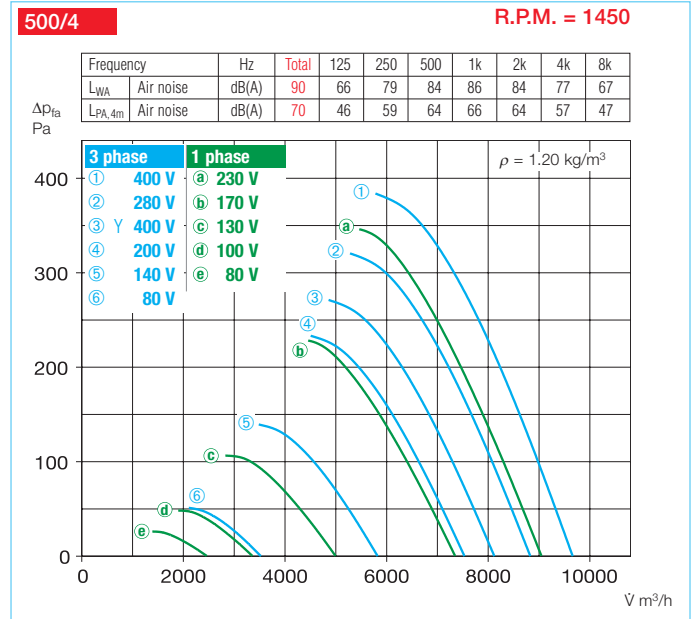
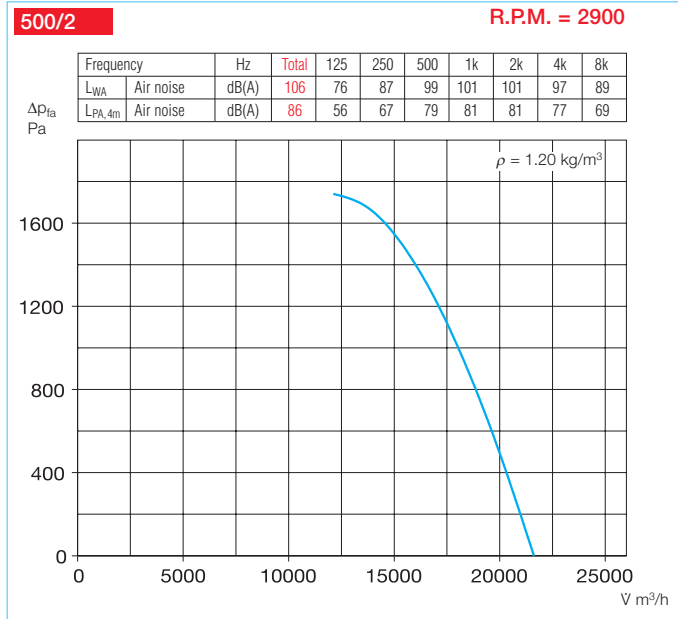

Other accessories	Page
Accessories for ex-proof fans	
Flanged flexible connector Type STS 500 Ex	Ref. no. 2507
Flexible sleeve Type FM 500 Ex	Ref. no. 1694
Attenuators	421 on
Shutters and grilles	487 on
Speed controllers and switches	525 on

Accessories Specification see page 231 on

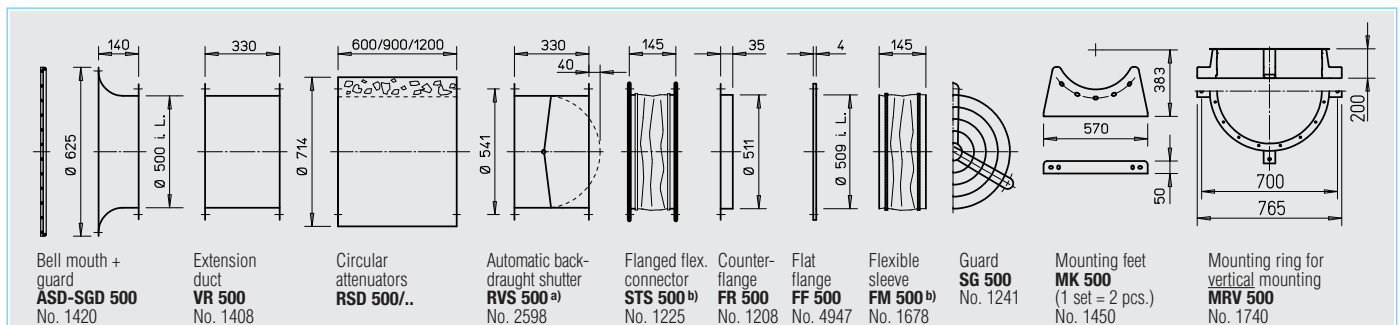

a) For motorised shutters see accessory pages

b) Types for explosion proof fans see left page

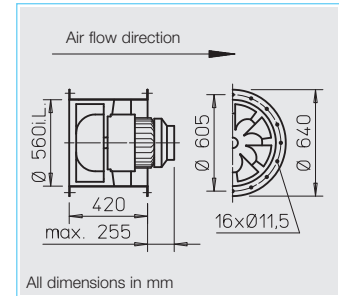

■ Specification

□ Casing

Manufactured in galvanised sheet steel with flanges on both sides to DIN 24155, Pt. 3, with fixed guide vanes and motor support.

□ Impeller

Optimised for high pressure and performance. Specially developed mixed-flow curved impeller manufactured from hot dipped galvanised steel.

□ Motor

Direct driven, maintenance free flange motor, totally enclosed with an aluminium casing and cooling fins, protected to IP 54. Sealed for life ball bearings with tropicalized protection of windings and interference-free. Optional drainage holes made to order (please state installation position).

□ Speed control

The voltage controllable models are identified by a value in the “speed controlled” column of the table below which must be used when selecting a controller (see controller column). The air flow volumes can be seen from the characteristic curves. Explosion proof fans are not controllable.

□ Electrical connection

Terminal box fitted externally on the casing as standard (IP 55).

□ Installation

Installation in any position. Ensure that motor drainage holes (where used) face downwards.

□ Motor protection

All models (excluding ex-proof models and pole switch models) have thermal contacts and PTC Thermistors as standard which must be connected to a full motor protection unit (see table below) for effective motor protection. Models without thermal contacts must be protected by a conventional circuit breaker.

□ Sound levels

Data shown within the performance curves refer to sound power levels. For determination of the lower sound pressure levels refer to diagram on “Technical information” page. Sound emission and acoustic information on page 10 on.

■ Information Page

Technical description	208
Selection chart	209
Information for planning	10 on

Made to order designs

Alternative voltages, frequencies, protection classes, acid protection, high temperatures etc. are available on request.

For safety and correct use note the technical information on page 15 on.

Type	Ref. no.	R.P.M.	Air flow volume (FID)	Motor power*	Voltage	Current*		Wiring diagram	Maximum air flow temp.		Nominal weight (net)	5 step transformer controller Pole switch		Full motor protection starter using the motor thermal contacts		Anti vibration mounts	
						standard supply	speed controlled		standard supply	speed controlled		Type	Ref. no.	Type	Ref. no.	comp	susp
		min ⁻¹	∇ m ³ /h	kW	V	A	A	No.	+°C	+°C	kg			Type	Type	Type	Type
Two-speed, 3 ph., 50 Hz, Y/Δ switch, protection to IP 54																	
VARD 560/4/4	6711	1130/1380	10780/12810	2.20/3.00	400Y/Δ	3.5/5.9	6.5	520	60	40	95.0	RDS 7¹⁾	1578	M 4²⁾	1571	SDD 2	SDZ 2
												Pole switch					
VARD 560/8/4	6790	705/1440	6590/13570	0.90/3.60	400	2.9/8.3	—	471	60	—	100.0	PDA 12³⁾	5081	—	—	SDD 2	SDZ 2
Explosion proof, E Exe II, 3 ph. / 50 Hz, temperature class T1-T3, protected to IP 54																	
VARD 560/8 Ex	6712	700	7120	0.37	400	1.61	—	470	40	—	85.0	not permitted	not permitted	SDD 2	SDZ 2		
VARD 560/6 Ex	6713	900	9360	1.10	400	3.10	—	470	40	—	90.0	not permitted	not permitted	SDD 2	SDZ 2		
VARD 560/4 Ex⁴⁾	6714	1440	14980	3.60	400	7.70	—	498	40	—	105.0	not permitted	not permitted	SDD 2	SDZ 2		

* Ex models: For nominal value of motor see information on page 16

¹⁾ includes full motor protection unit

²⁾ includes operation and speed switch

³⁾ see product page for flush mounted version

⁴⁾ Vibration monitoring is necessary (on site) pursuant to DIN EN 14986.

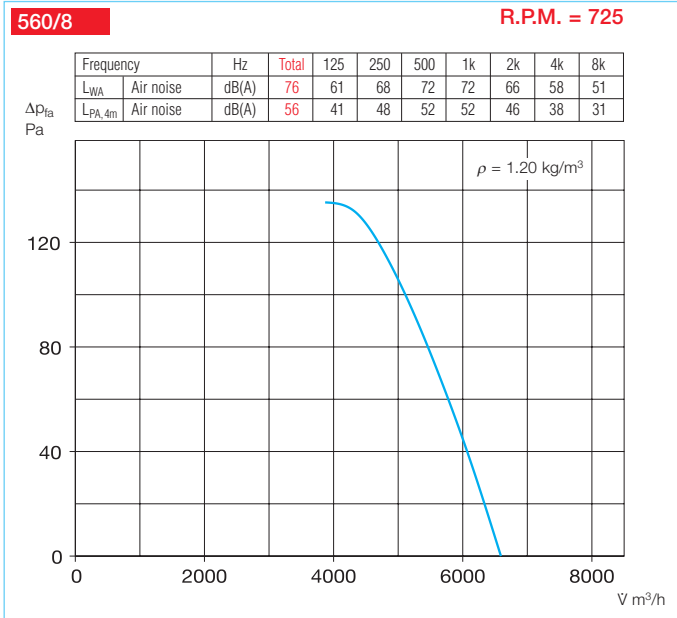
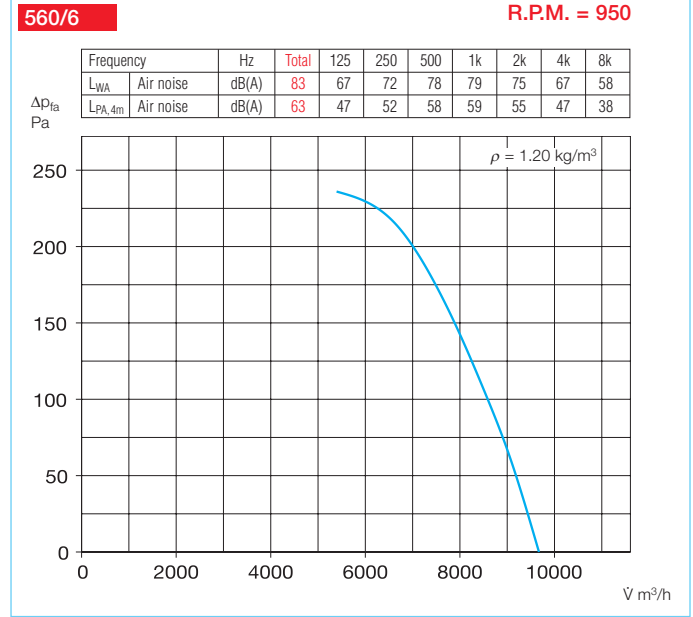
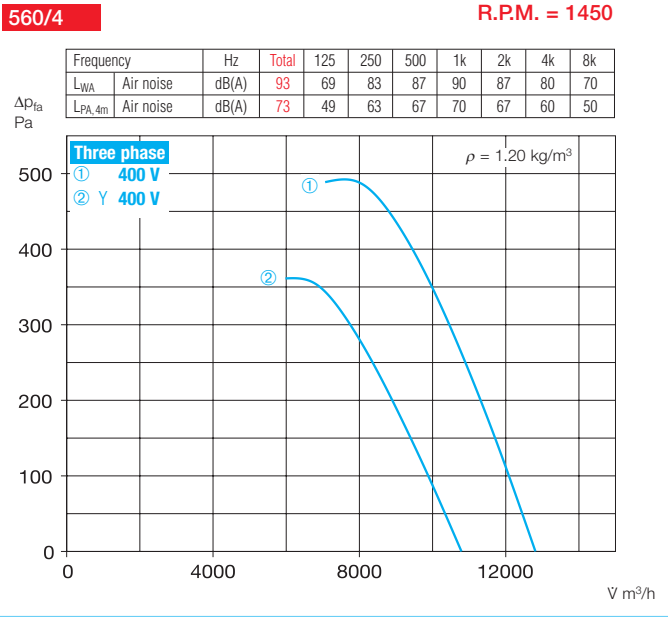

Other accessories	Page
b) Accessories for ex-proof fans	
Flanged flexible connector	
Type STS 560 Ex	Ref. no. 2508
Flexible sleeve	
Type FM 560 Ex	Ref. no. 1695
Attenuators	421 on
Shutters and grilles	487 on
Speed controllers and switches	525 on

Accessories Specification see page 231 on

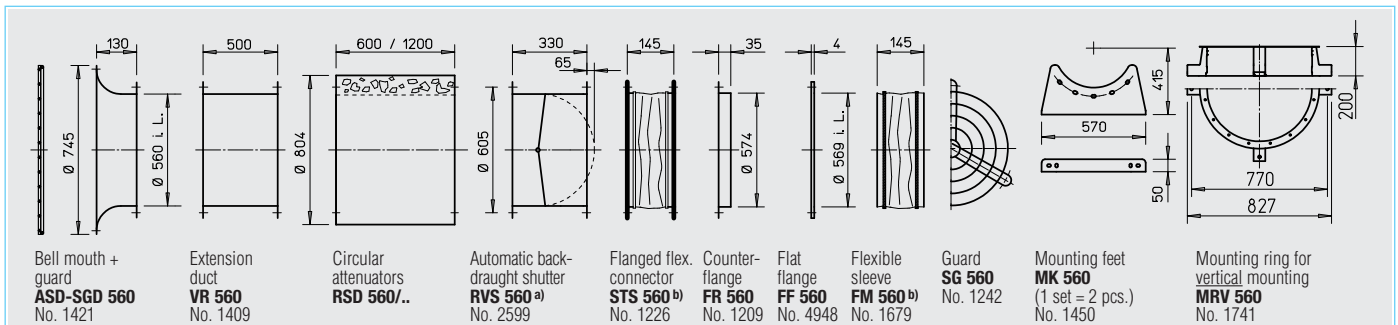

a) For motorised shutters see accessory pages

b) Types for explosion proof fans see left page

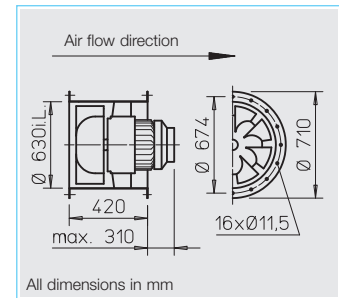

■ Specification

□ Casing

Manufactured in galvanised sheet steel with flanges on both sides to DIN 24155, Pt. 3, with fixed guide vanes and motor support, hot dipped galvanised.

□ Impeller

Optimised for high pressure and performance. Specially developed mixed-flow curved impeller manufactured from hot dipped galvanised steel.

□ Motor

Direct driven, maintenance free flange motor, totally enclosed with an aluminium casing and cooling fins, protected to IP 54. Sealed for life ball bearings with tropicalized protection of windings and interference-free. Optional drainage holes made to order (please state installation position).

□ Speed control

Stepless (0-100%) by using a frequency inverter (excluding pole switch models). If the fan is to be controlled by a frequency inverter without a sine filter, this must be stated when ordering. This requires a change of fan design and potential additional costs. Explosion proof fans are not controllable.

□ Electrical connection

Terminal box fitted externally on the casing as standard (IP 55).

□ Installation

Installation in any position. Ensure that motor drainage holes (where used) face downwards.

□ Motor protection

Model VARD 630/4 has PTC thermistors which must be connected to a full motor protection unit (see table below) for effective motor protection. Models without thermal contacts must be protected by a conventional circuit breaker.

□ Sound levels

Data shown within the performance curves refer to sound power levels. For determination of the lower sound pressure levels refer to diagram on "Technical information" page. Sound emission and acoustic information on page 10 on.

■ Information Page

Technical description	208
Selection chart	209
Information for planning	10 on

Made to order designs

Alternative voltages, frequencies, protection classes, acid protection, high temperatures etc. are available on request.

For safety and correct use note the technical information on page 15 on.

Type	Ref. no.	R.P.M.	Air flow volume (FID)	Motor power*	Voltage	Current*		Wiring diagram	Maximum air flow temp.		Nominal weight (net)	5 step transformer controller Pole switch		Full motor protection starter using the motor thermal contacts		Anti vibration mounts	
						standard supply	speed controlled		supply	speed controlled		Type	Ref. no.	Type	Ref. no.	comp	susp
			min ⁻¹	V m ³ /h	V	A	A	No.	+°C	+°C	kg	Type	Ref. no.	Type	Ref. no.	Type	Type
3 Phase motor, 50 Hz, protection to IP 54																	
VARD 630/4	6717	1440	21320	6,20	400	12,0/6,9	—	776	60	—	145,0	FU-BS 14 ¹⁾	5463	MSA ⁴⁾	1289	SDD 2	SDZ 2
												Pole switch					
VARD 630/8/4	6792	715/1430	10590/21170	1,40/5,50	400	5,0/12,0	—	471	60	—	145,0	PDA 12 ³⁾	5081	—	—	SDD 2	SDZ 2
Explosion proof, E Exe II, 3 ph. / 50 Hz, temperature class T1-T3, protection to IP 54																	
VARD 630/8 Ex	6718	700	10220	0,95	400	2,75	—	470	40	—	110,0	not permitted	not permitted	SDD 2	SDZ 2		
VARD 630/6 Ex	6719	950	13990	1,90	400	4,70	—	470	40	—	130,0	not permitted	not permitted	SDD 2	SDZ 2		
VARD 630/4 Ex ⁵⁾	6720	1435	21400	6,80	400	13,1	—	498	40	—	165,0	not permitted	not permitted	SDD 2	SDZ 3		

* Ex models: For nominal value of motor see information on page 16

³⁾ see product page for flush mounted version

¹⁾ includes full motor protection unit and Sine filter

⁴⁾ for PTC Thermistor temp. sensor

²⁾ includes operation and speed switch

⁵⁾ Vibration monitoring is necessary (on site) pursuant to DIN EN 14986.

630/4

R.P.M. = 1450

Frequency	Hz	Total	125	250	500	1k	2k	4k	8k
L _{WA} Air noise	dB(A)	97	73	89	91	93	91	84	74
L _{PA,4m} Air noise	dB(A)	77	53	69	71	73	71	64	54

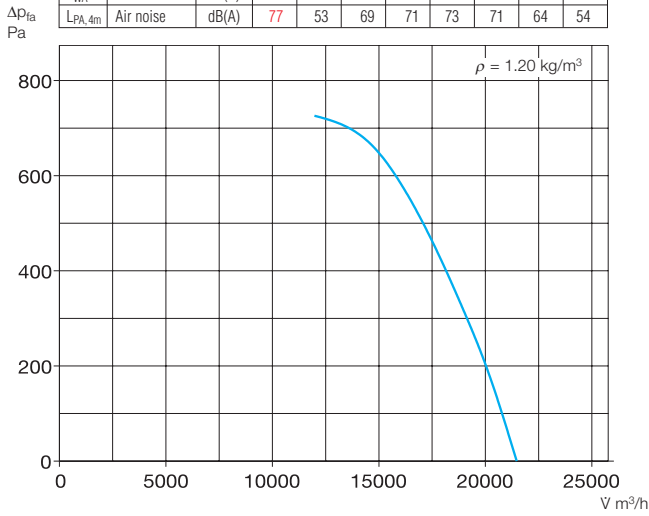

630/6

R.P.M. = 950

Frequency	Hz	Total	125	250	500	1k	2k	4k	8k
L _{WA} Air noise	dB(A)	87	70	76	82	83	78	70	62
L _{PA,4m} Air noise	dB(A)	67	50	56	62	63	58	50	42

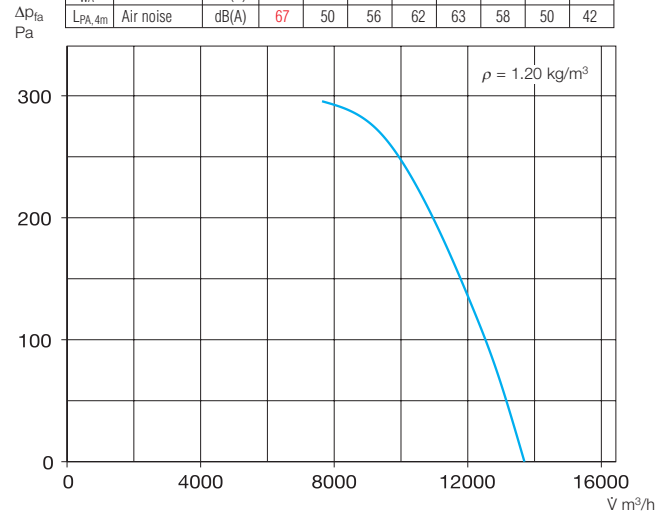

630/8

R.P.M. = 725

Frequency	Hz	Total	125	250	500	1k	2k	4k	8k
L _{WA} Air noise	dB(A)	80	65	71	76	75	70	62	55
L _{PA,4m} Air noise	dB(A)	60	45	51	56	55	50	42	35

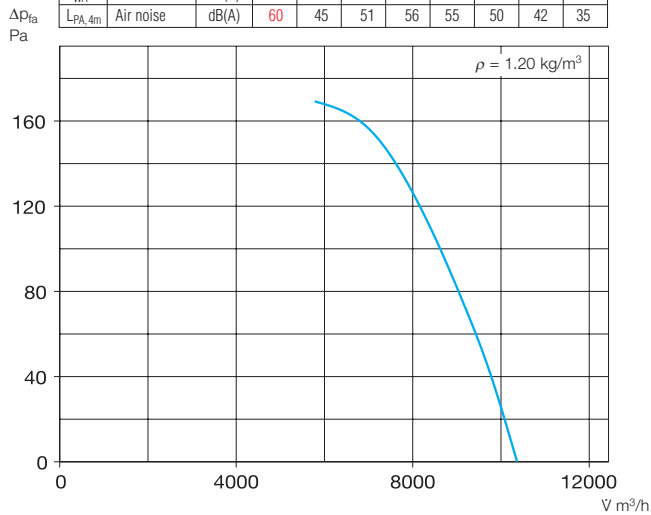

Other accessories Page

b) Accessories for ex-proof fans

- Flanged flexible connector**
- Type STS 630 Ex Ref. no. 2509
- Flexible sleeve**
- Type FM 630 Ex Ref. no. 1696

- Attenuators 421 on
- Shutters and grilles 487 on
- Speed controllers and switches 525 on

Accessories Specification see page 231 on

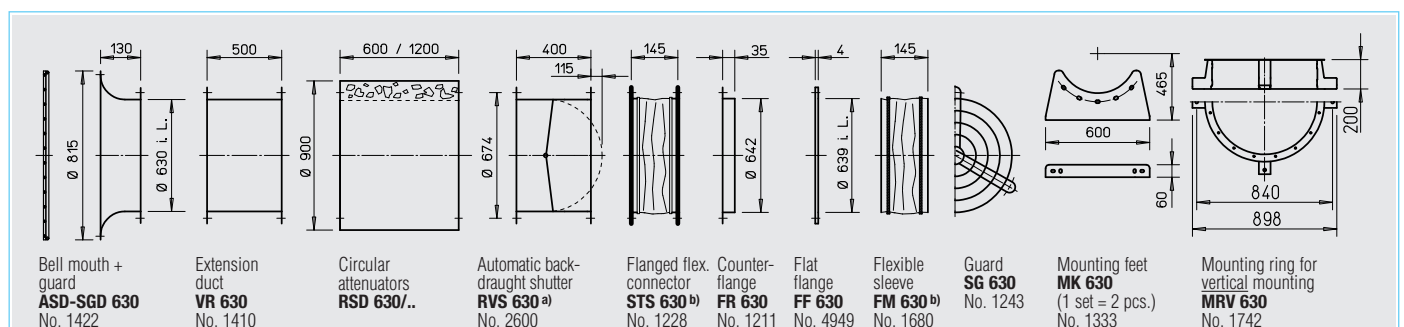

a) For motorised shutters see accessory pages

b) Types for explosion proof fans see left page

For everything to run like clockwork during installation.

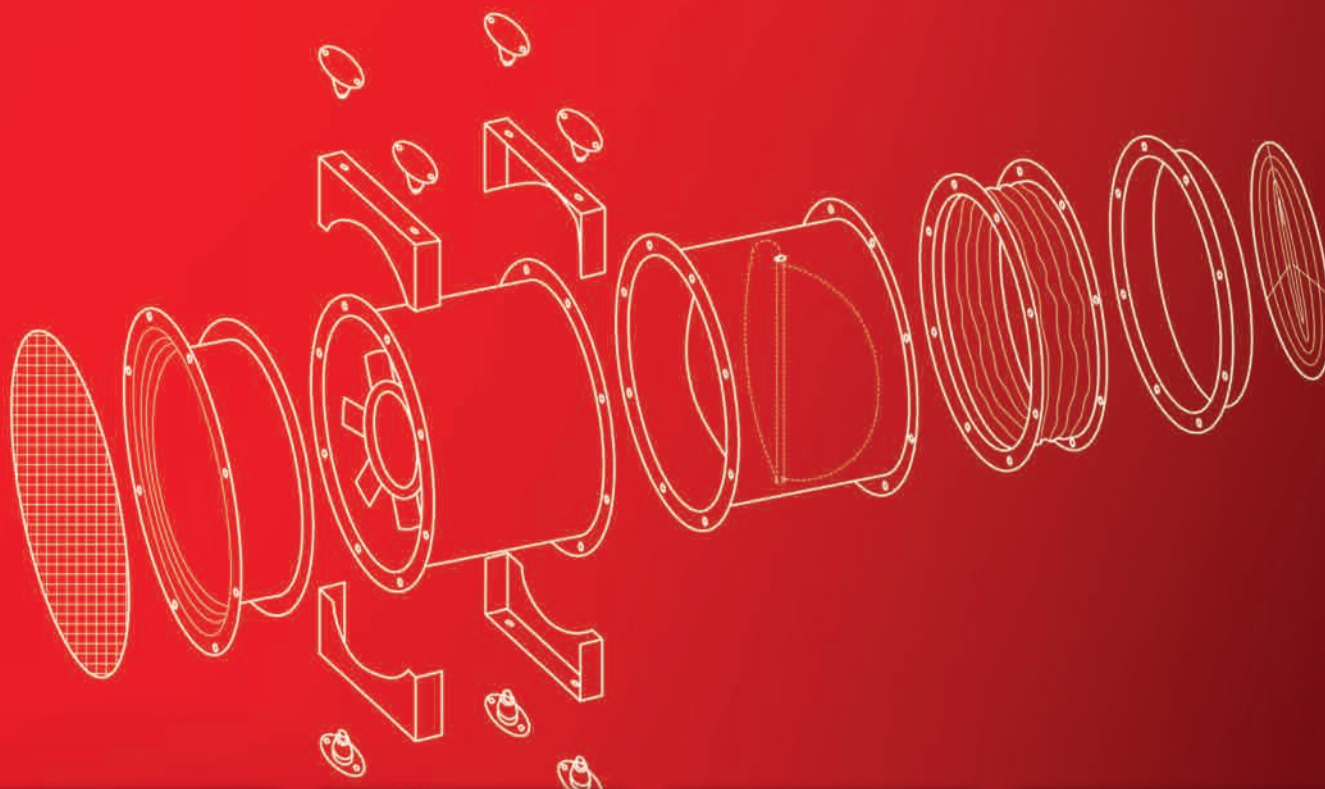

**INSTALLATION
ACCESSORIES
IN-LINE FANS**

Whatever is needed for installation and line connection: The wide range available from Helios includes the matching system components. From the suction nozzle to the electrical backdraught shutters and the vibration dampers.

231^{on}

**ATTENUATORS
AIR FILTERS
HEATER BATTERIES**

Helios air treatment components ensure clean, warm and smooth air. The extensive range includes all sizes and powers, perfectly coordinated to Helios fans. This allows the necessary flexibility in terms of planning and installation.

421^{on}

**BACKDRAUGHT
SHUTTERS
VENTILATION GRILLES**

Weather-proof and anti-corrosive. Long service life, made from unbreakable UV-resistant polymer. Helios backdraught shutters and weather protection grilles have pleasant shapes, impressive robustness and are easy to install.

487^{on}

**CONTROLLERS
INVERTERS
SWITCHES**

In addition to the special installation accessories for in-line fans, Helios offers a variety of regulation, control and switching devices, which are perfectly tailored to the in-line fans.

525^{on}

ASD-SGD

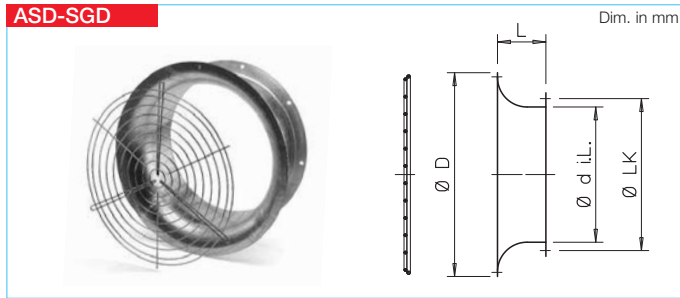

Bell mouth + guard and large inlet radius. Made from hot dipped galvanised sheet steel. Connection side with flange

to DIN 24155, Pt. 2. Powder-coated guard for intake-side cover (from Ø 800 galvanised), protection to DIN EN ISO 13857.

Type	Ref. no.	Ø D	L	Ø d i.L.	Ø LK	Weight in kg
ASD 200*	1388	310	140	203	235	0.9
ASD-SGD 225	1413	345	140	225	259	2.5
ASD-SGD 250	1414	370	140	250	286	2.8
ASD-SGD 280	1415	400	140	280	322	3.2
ASD-SGD 315	1416	435	140	315	356	3.5
ASD-SGD 355	1417	475	140	355	395	4.0
ASD-SGD 400	1418	545	140	400	438	4.5
ASD-SGD 450	1419	595	140	450	487	5.7
ASD-SGD 500	1420	625	140	500	541	6.3
ASD-SGD 560	1421	745	130	560	605	7.0
ASD-SGD 630	1422	815	130	630	674	7.6
ASD-SGD 710	1423	955	200	710	751	19.5
ASD-SGD 800	1424	1060	200	800	837	22.3
ASD-SGD 900	1309	1140	200	900	934	25.0
ASD-SGD 1000	1310	1240	200	1000	1043	28.5

* without guard

SG

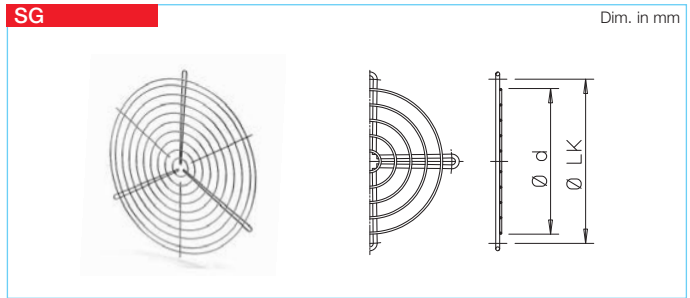

Guard to cover impeller opening. Powder-coated, colour: silver-metallic (from Ø 800 galvanised).

Dimensions and holes to match fan-flange tube nom. size DIN 24155, Pt. 2. Protection to DIN EN ISO 13857.

Type	Ref. no.	Ø d	Ø LK	Weight in kg	Number of fixing points
SG 200	1216	190	235	0.1	3
SG 225	1215	224	259	0.2	3
SG 250	1236	241	286	0.2	3
SG 280	1428	270	322	0.3	4
SG 315	1237	310	356	0.4	4
SG 355	1238	350	395	0.4	4
SG 400	1239	390	438	0.5	3
SG 450	1240	450	487	0.6	3
SG 500	1241	490	541	0.7	3
SG 560	1242	550	605	0.9	4
SG 630	1243	630	674	1.5	4
SG 710	1244	710	751	1.8	4
SG 800	1245	790	837	2.2	4
SG 900	1246	890	934	2.7	4
SG 1000	1290	990	1043	3.5	4

RVS

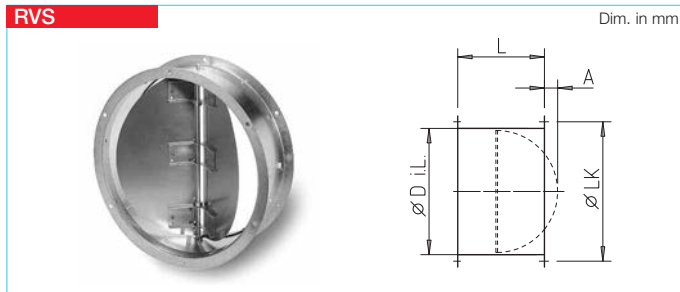

Automatic backdraught shutter with spring closing¹⁾

Horizontal installation for air flow in any direction. Vertical for with air flow direction going upwards. Automatic opening on fan operation. Spring mechanism for closing. Closing force adjustable to suit fan

power and installation position. Spring mechanism outside the air flow. Shutters and casing manufactured from galvanised steel, ND 225-560 shutters made from aluminium. Flanges on both sides, drillings to DIN 24155, Pt. 2.

Type ²⁾	Ref. no.	Ø D i.L.	L	A	Ø LK	Weight in kg
RVS 225	2591	225	300	—	259	3.0
RVS 250	2592	250	300	—	286	3.4
RVS 280	2593	280	300	—	322	3.9
RVS 315	2594	315	300	—	356	4.3
RVS 355	2595	355	300	—	395	5.0
RVS 400	2596	400	330	—	438	7.2
RVS 450	2597	454	330	15	487	10.4
RVS 500	2598	504	330	40	541	11.7
RVS 560	2599	560	330	65	605	16.1
RVS 630	2600	630	400	115	674	19.5
RVS 710	2601	710	400	155	751	26.5
RVS 800	2602	800	420	200	837	37.3
RVS 900	2603	900	420	250	934	41.8
RVS 1000	2604	1000	420	300	1043	47.3

¹⁾ Pressure loss diagram see page 490

²⁾ Ambient temperature -30 to +100 °C

RVM

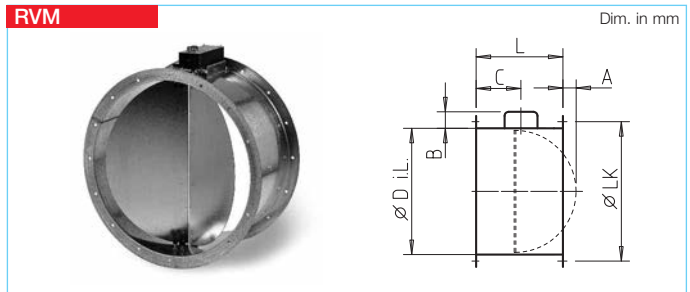

Motorised backdraught shutter¹⁾

as RVS, but with spring reversing motor (outside the air flow). Installation in any position vertically and horizontally. Recommended electrical connection in parallel to fan. Connection with 0.9 m long lead.

Ambient temperature -30 to +60 °C
Protection class IP 54
Voltage/Frequency 230 V AC, 50/60 Hz
Power 14 W/6.5 W
Opening time approx. 75 sec.
Wiring diagram no. 380.1

Type ³⁾	Ref. no.	Ø D i.L.	B	C	L	A	Ø LK	Weight in kg
RVM 225	2575	225	95	130	300	—	259	3.3
RVM 250	2576	250	95	130	300	—	286	3.7
RVM 280	2577	280	95	130	300	—	322	4.2
RVM 315	2578	315	95	130	300	—	356	4.6
RVM 355	2579	355	95	130	300	—	395	5.3
RVM 400	2580	400	95	130	330	—	438	7.5
RVM 450	2581	454	95	130	330	15	487	10.7
RVM 500	2582	504	95	130	330	40	541	12.0
RVM 560	2583	560	95	130	330	65	605	16.4
RVM 630	2609	630	150	225	400	115	674	21.0
RVM 710	2610	710	150	225	400	155	751	28.0
RVM 800	2614	800	150	225	420	200	837	37.8
RVM 900	2615	900	150	225	420	250	934	42.3
RVM 1000*	2616	1000	150	225	420	300	1043	47.8

³⁾ Type RVM not for use in Ex-areas. * RVM 1000 only for horizontal flow.

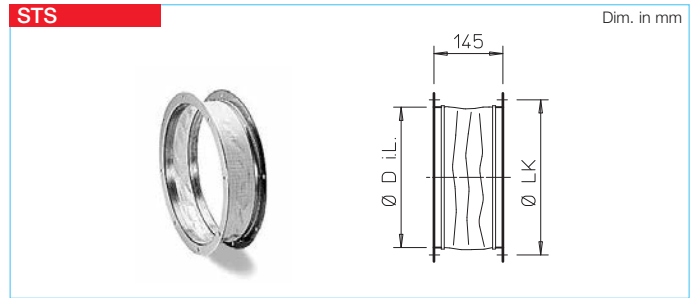
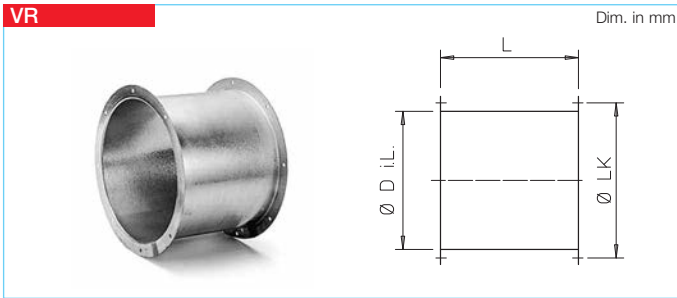

Extension duct

Ducting with flanges on both sides and holes to DIN 24155, Pt. 2. Manufactured from galvanised steel, to elongate the fan casing.

For models where the motor protrudes from the casing when installed into ducting. Avoids drops in performance at free extract.

Type	Ref. no.	Ø D i.L.	L	Ø LK	Weight in kg
VR 225	1401	225	300	259	2.5
VR 250	1402	250	300	286	2.8
VR 280	1403	280	300	322	3.2
VR 315	1404	315	300	356	3.5
VR 355	1405	355	300	395	4.0
VR 400	1406	400	330	438	6.0
VR 450	1407	454	330	487	9.0
VR 500	1408	504	330	541	10.0
VR 560	1409	560	500	605	14.0
VR 630	1410	630	500	674	15.5
VR 710	1411	710	500	751	21.5
VR 800	1412	800	420	837	31.0
VR 900	1311	900	420	934	34.0
VR 1000	1312	1000	420	1043	37.6

Flanged flexible connector

Flexible connector to be fitted between fan and ducting to reduce vibration transmission and to correct small site misalignments.

Flexible sleeve consists of a silicon free polymer fabric cloth and has zinc plated metal flanges fitted at both ends (max. + 80 °C). Dimensions to DIN 24155, Pt. 2.

Type	Ref. no.	Type*	Bestell-Nr.	Ø D i.L.	Ø LK	Weight in kg
STS 200	1219	—	—	205	235	1.3
STS 225	1218	STS 225 Ex	2500	229	259	1.1
STS 250	1220	STS 250 Ex	2501	252	286	1.3
STS 280	1231	STS 280 Ex	2502	288	322	1.5
STS 315	1221	STS 315 Ex	2503	322	356	1.8
STS 355	1222	STS 355 Ex	2504	361	395	2.3
STS 400	1223	STS 400 Ex	2505	404	438	2.5
STS 450	1224	STS 450 Ex	2506	453	487	3.8
STS 500	1225	STS 500 Ex	2507	507	541	3.4
STS 560	1226	STS 560 Ex	2508	570	605	4.5
STS 630	1228	STS 630 Ex	2509	638	674	4.6
STS 710	1229	STS 710 Ex	2510	711	751	7.0
STS 800	1233	STS 800 Ex	2511	801	837	7.5
STS 900	1234	STS 900 Ex	2512	898	934	7.5
STS 1000	1235	STS 1000 Ex	2513	1004	1043	15.0

* for explosion-proof fans

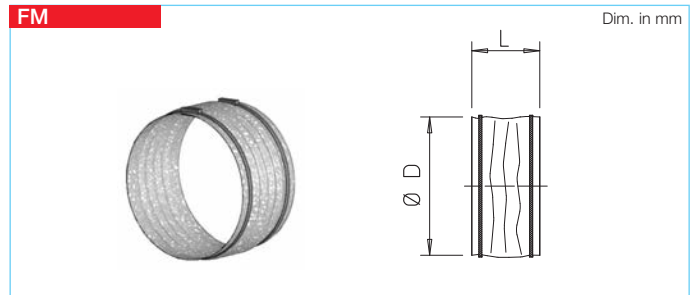
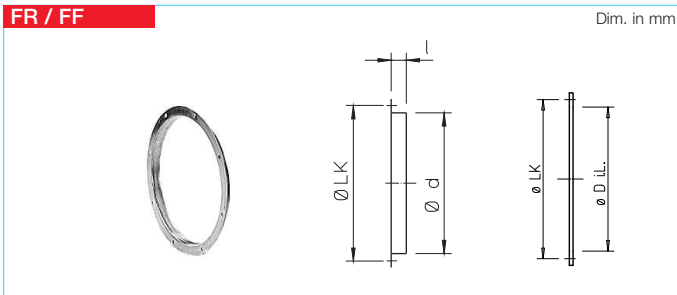

Counterflange FR / flat flange FF

Angled flange ring / flat flange ring made from galvanised sheet steel. Dimensions / holes according to DIN 24155 Pt. 2.

Type	Ref. no.	Type	Ref. no.	Ø LK	l	Ø d	Ø d i.L.	Weight in kg
FR 200	1202	—	—	235	25	209	—	0.5
FR 225	1201	—	—	259	30	233	—	0.5
FR 250	1203	FF 250	4941	286	25	256	256	0.7
FR 280	1214	FF 280	4942	322	30	292	286	0.9
FR 315	1204	FF 315	4943	356	30	326	321	1.0
FR 355	1205	FF 355	4944	395	30	365	361	1.1
FR 400	1206	FF 400	4945	438	30	408	409	1.2
FR 450	1207	FF 450	4946	487	35	457	459	1.3
FR 500	1208	FF 500	4947	541	35	511	509	1.5
FR 560	1209	FF 560	4948	605	35	574	569	2.1
FR 630	1211	FF 630	4949	674	35	642	639	2.3
FR 710	1212	FF 710	4950	751	35	715	719	3.1
FR 800	1198	FF 800	4951	837	35	806	809	3.9
FR 900	1199	FF 900	4952	934	35	903	909	4.4
FR 1000	1210	FF 1000	4953	1043	35	1012	1009	9.5

Flexible sleeve

Flexible connector incl. 2 worm drive clips to be fitted between fan and ducting to reduce vibration transmission and to correct small

misalignments. Flexible sleeve made from silicon-free PVC fabric (max. temp. +80 °C). Dimensions to DIN 24155, Pt. 2.

Type	Ref. no.	Type*	Ref. no.	Ø D	L	Weight in kg
FM 200	1670	FM 200 Ex	1686	213	145	0.2
FM 225	1671	FM 225 Ex	1687	235	145	0.2
FM 250	1672	FM 250 Ex	1688	260	145	0.2
FM 280	1673	FM 280 Ex	1689	296	145	0.2
FM 315	1674	FM 315 Ex	1690	330	145	0.2
FM 355	1675	FM 355 Ex	1691	369	145	0.3
FM 400	1676	FM 400 Ex	1692	412	145	0.3
FM 450	1677	FM 450 Ex	1693	461	145	0.3
FM 500	1678	FM 500 Ex	1694	515	145	0.4
FM 560	1679	FM 560 Ex	1695	577	145	0.4
FM 630	1680	FM 630 Ex	1696	646	145	0.4
FM 710	1666	—	—	720	145	0.5

* for explosion-proof fans

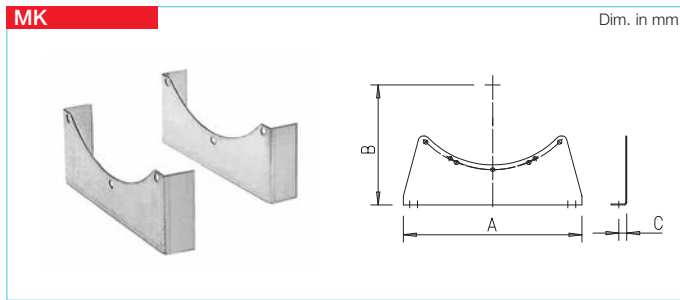

Mounting feet

To fix fan flange casing to ceilings, walls or floors. Made from hot-dipped galvanised steel. Fixing holes fit casing flanges. Set includes a pair of feet, nuts and bolts.

Note:

If motors of high weight are installed, an extension duct (VR) is recommended to move the centre of gravity within the mounting feet. Mount feet on the outer flange.

Type	Ref. no.	A	B	C	Weight in kg
MK 200-225	1446	310	208/220	20	1.5
MK 250-280	1447	340	227/245	20	1.7
MK 315-355	1448	380	281/300	25	2.2
MK 400-450	1449	360	311/335	25	2.6
MK 500-560	1450	570	383/415	25	5.3
MK 630	1333	600	465	30	8.5
MK 710	1372	670	515	35	10.5
MK 800	1373	680	565	35	15.5
MK 900	1374	760	625	35	18.0
MK 1000	1375	840	690	35	19.5

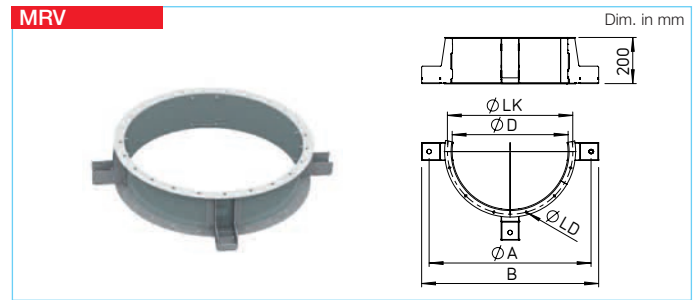

Mounting ring MRV

The mounting ring MRV is provided for the vertical mounting of fans (e.g. Helios types AVD, AMD, VAR etc.). Four mounting brackets for

direct mounting or anti-vibration dampers (SDZ or SDD) ensure the secure vertical mounting of fans. Made from galvanised sheet steel.

Type	Ref. no.	Ø A	B	Ø D	Ø LK	Ø LD	Weight	Max. load capacity
MRV 315	1755	510	576	315	356	9,5 (8x)	6.5 kg	280 kg
MRV 355	1759	550	618	355	395	9,5 (8x)	6.9 kg	280 kg
MRV 400	1760	595	662	400	438	9,5 (12x)	7.4 kg	280 kg
MRV 450	1761	650	714	450	487	9,5 (12x)	7.9 kg	280 kg
MRV 500	1740	700	765	500	541	9,5 (12x)	8.3 kg	280 kg
MRV 560	1741	770	827	560	605	11,5 (16x)	12.9 kg	390 kg
MRV 630	1742	840	898	630	674	11,5 (16x)	13.9 kg	390 kg
MRV 710	1743	920	980	710	751	11,5 (16x)	15.7 kg	390 kg
MRV 800	1744	1030	1101	800	837	11,5 (24x)	24.8 kg	1050 kg
MRV 900	1745	1130	1201	900	934	11,5 (24x)	27.0 kg	1050 kg
MRV 1000	1749	1230	1301	1000	1043	11,5 (24x)	29.1 kg	1050 kg

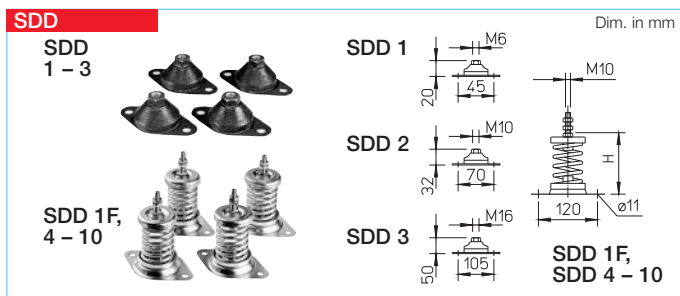

Anti vibration mounts for compression

To reduce noise and vibration transmission of fans installed on horizontal surfaces. Simple installation in combination with feet MK (accessory). Select size according to fan weight see table).

Rubber elements are suitable for small to middle weights and ambient temperatures up to +60 °C. Spring elements are suitable for higher temperatures above +60 °C (e.g. smoke extraction).

Type	Ref. no.	max. fan weight kg	H Height in mm	Spring element	Contents 1 set = 4 pieces
SDD 1	1452	80	*		
SDD 1F	1942	70	112 – 82	•	
SDD 2	1453	180	*		
SDD 3	1367	750	*		
SDD 4	1944	130	112 – 86	•	
SDD 5	1924	210	112 – 86	•	
SDD 6	1926	400	112 – 80	•	
SDD 7	1928	580	112 – 82	•	
SDD 8	1930	900	112 – 82	•	
SDD 9	1934	1300	112 – 85	•	
SDD 10	1951	1800	112 – 88	•	

* specified in dimensional drawing

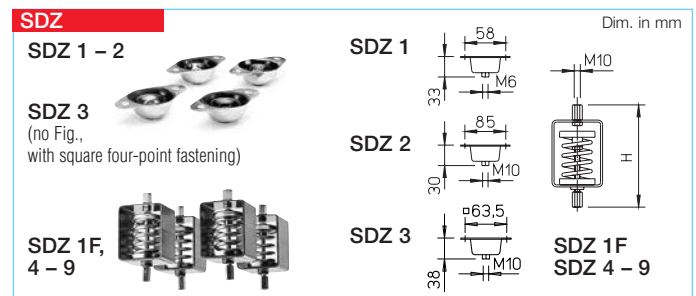

Anti vibration mounts for suspension

To reduce noise and vibration transmission of fans installed hanging from ceilings. Specification as model SDD.

Important note for installation of anti vibration mounts!

Make sure that fan system is well balanced (centre of gravity of heavy motor may cause uneven loading of mounts).

Type	Ref. no.	max. fan weight kg	H Height in mm	Spring element	Contents 1 set = 4 pieces
SDZ 1	1454	60	*		
SDZ 1F	1943	70	190 – 220	•	
SDZ 2	1455	160	*		
SDZ 3	1366	300	*		
SDZ 4	1945	130	190 – 216	•	
SDZ 5	1925	210	190 – 216	•	
SDZ 6	1927	400	190 – 221	•	
SDZ 7	1929	580	190 – 220	•	
SDZ 8	1931	900	190 – 220	•	
SDZ 9	1935	1300	190 – 217	•	

* specified in dimensional drawing

The "All-rounder" with huge talent: GigaBox from Helios.



GigaBoxes are truly multi-functional talents which offer almost limitless flexibility in a number of different areas of application. Compact frame construction and easy-to-install accessories facilitate variable and therefore optimal adjustment to the structural conditions thanks to the simple implementation of the casing panels. With five or (in the T120 series) three possible exhaust directions, you are free to choose where you want to install and how you want to position the fan.

The GigaBoxes are ideally suited to conveying medium to large air flow volumes against high resistances in all kinds of ventilation systems. GigaBoxes from Helios are delivered as standard with the following items:

- Shaped piece on the exhaust side from square to round for low-loss discharge,
- Flexible sleeves to prevent structure-borne sound and for connection to ducts with common standard diameters.

GIGABOX T120
UP TO MAX. 120 °C



250^{on}

The GB T120 range is predestined to convey contaminated, hot air up to a maximum of 120 °C.

- Motor lies outside the flow line.
- Heat-insulated partition wall between the motor and impeller.
- Easy-to-access motor impeller unit.

Whenever high air flow temperatures or a large moisture content or steam is present in the exhaust air, the GigaBox T120 is ideal to use in exhaust air systems for process technology or in commercial kitchens.



**GIGABOX
CENTRIFUGAL FANS**
Product-specific information and selection chart

236^{on}

Energy-efficient
EC version
Ø 250 – 710 mm
V = 2010 – 19630 m³/h

239^{on}

Standard AC types
Ø 250 – 710 mm
V = 1420 – 20280 m³/h

Available in T120 version
up to max. 120 °C

248^{on}

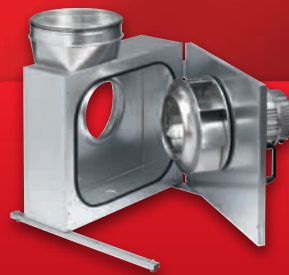

**MEGABOX
CENTRIFUGAL FANS**
Product-specific information and selection chart

264^{on}

Energy-efficient
EC version
Ø 225 – 400 mm
V = 1350 – 6550 m³/h

266^{on}

Standard AC types
Ø 160 – 400 mm
V = 960 – 7500 m³/h

275^{on}

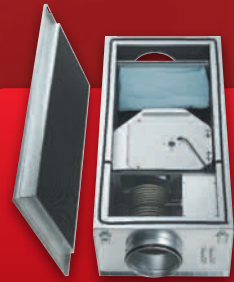

FRESH AIR BOXES
with electric or warm water heating and air filter

284^{on}

GigaBox and accessories

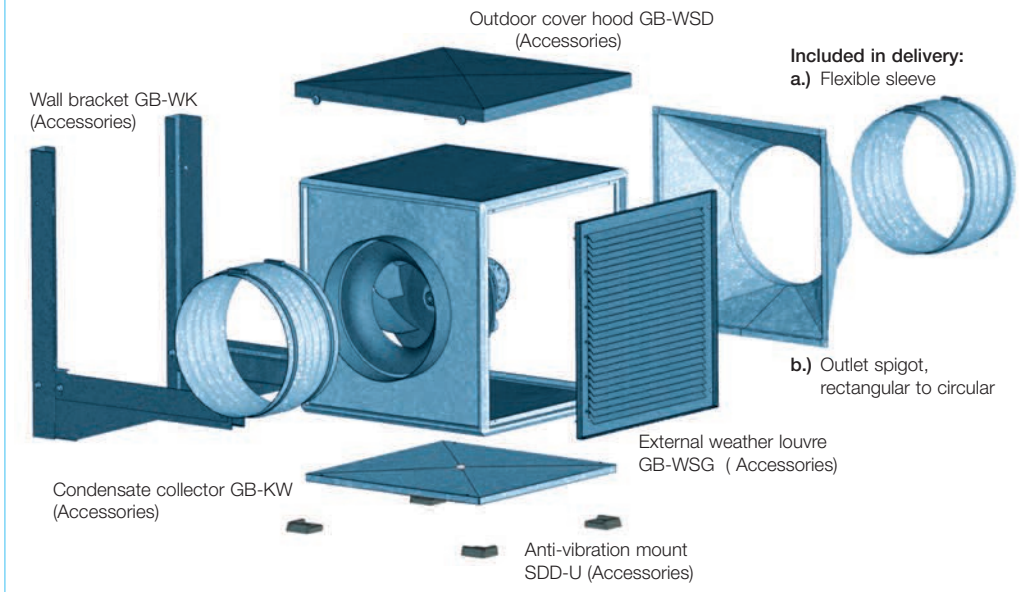

Information	Page
Information for planning, acoustics	10
General techn. information, speed control	15

Application

Multifunctional fan box, suitable for medium to higher air flow volumes against high resistances in every type of ventilation system. The compact frame construction offers easy conversion of the outlet position, together with a choice of ideal accessories make these units ideal for all applications.

GB T120

The GigaBox T120 types are suitable for the extraction of dirty, humid and hot air up to max. 120 °C, such as extract air fan in commercial kitchens and many process technology applications.

GB EC

GigaBox types with EC motor technology are available for energy-saving application and lowest operating costs.

Casing

Self-supporting frame construction from aluminium hollow profiles. Double-walled side panels from galvanised sheet steel, lined with 20 mm thick temperature insulating and flame-retardant mineral wool.

Intake cone for ideal airflow, spigot and flexible connector for duct connection. With outlet adapter (from rectangular to circular) on the exhaust side for low-loss discharge and flexible connector to reduce vibration transmission.

The flexible connectors are supplied as standard and correspond to the max. permissible air flow temperature of +70 °C and/or +120 °C with the types GB T120. Easy positioning with crane hooks as standard.

With GB T120, the motor is located outside of the air flow.

The thermally insulated partition panel is also the support plate for the motor and impeller unit and can be removed completely for inspection without removing the complete fan from the system.

Speed control

GB and GB T120

All types (except GBD 630/4 T120, GBD 710/4 and GBD 710/4 T120) are speed controllable by voltage reduction using a 5-step transformer controller or an electronic controller. The 3-phase GB types can also be 2 speed controlled by Y/Δ switch (accessories DS 2 or full motor protection device M4). The performances stages are specified in the performance curve. 3-phase models are controllable by means of frequency inverter with Sine filter (FU-BS, accessories); GBD 630/4 T120, GBD 710/4 and GBD 710/4 T120 only controllable by frequency inverter FU-BS.

GB EC

All EC types are steplessly speed-controllable by means of speed-potentiometer. Furthermore, control is also possible by means of three-step switch or steplessly via a universal control system or electronic differential pressure/temperature controller. The example performances stages are specified in the performance curve.

Assembly, Installation

GB and GB EC

Installation in any position and flexible assembly using the five possible discharge directions via the discharge adapter. Removable panels allow inspection access on all sides.

GB T120

Installation must be carried out with downward condensation discharge. Flexible assembly through three possible centrifugal discharge directions via the discharge adapter. Easy-access inspection cover with handle, for cleaning and maintenance. Easy positioning of all types with integrated crane hooks. Vibration transmission to the building is minimised with anti-vibration mounts (Type SDD-U, accessories). Vibration transmission to the ducting is prevented using the standard flexible connector supplied.

Impeller

Free-running high-performance centrifugal impeller with backward curved polymer blades (NG 250 made from steel) on a galvanised steel back plate, direct driven. Series GB EC, GB from NG 500 and GB T120 with aluminium impellers. Energy-efficient with low noise generation. Dynamically balanced together with the motor according to DIN ISO 1940 T.1 – grade 6.3 or 2.5.

Motor

GB and GB T120

IEC-standard motor or maintenance-free external rotor motor protected to IP 54 or 44. Thermal overload protection through built-in thermal contacts. Suitable for continuous operation S1. Insulation class F. Ball bearings are lubricated for life.

GB EC

Energy-saving, speed-controllable EC external rotor motor protected to IP 54 with high level of efficiency. Maintenance-free and interference-free, ball bearing mounted.

Electrical connection

GB and GB T120

Standard terminal box, protected to IP 54.

GB EC

Standard terminal box (IP 54) mounted to running cable.

Air flow direction

The air flow direction of centrifugal fans is not reversible, but can be set by positioning the fan to the required air flow direction. Furthermore the position can be set individually to constructional conditions through the conversion of the discharge adapter and panels. The correct motor rotation direction is marked by rotation arrows on the motor and must be checked at start-up.

Incorrect direction of rotation

If the fan is operated in the incorrect direction of rotation, the motor will overheat and the thermal contact will trip. A typical indication of this is a very low air flow combined with high noise levels and vibration.

Air flow temperature

The maximum permitted air flow temperature is specified in the type table.

Ambient temperature

From –40 °C to +40 °C.

VDI 2052 (2006) "Ventilation equipment for kitchens – Planning, design, inspection" is applied when planning exhaust air systems in commercial kitchens. This means the following for exhaust air fans:

- Fans in exhaust air systems must be designed and fitted so that they are easy to access, easy to control and easy to clean. It must be possible to turn them off from inside the kitchen. The motors must be located outside the flow line of the exhaust air. Connected extractor hoods must be able to distinguish between solid and liquid components where possible. Passage of flame to the following components is to be prevented.

These specific requirements are excellently fulfilled in the GigaBox GB T120. Freely accessible casing and dual-wall side panels allow easy cleaning with degreasing agents and steam.

The guidelines on fire safety requirements for ventilation systems (LüAR) from September 2006 have been introduced across large areas of Germany.

This places the following additional requirements on exhaust air systems in commercial and comparable kitchens:

- Exhaust air ducts must be made of non-flammable components (building material class A1 or A2 according to DIN 4102). From the kitchen outlet, they have to have at least a fire resistance class of L90 or must be equipped with a shut-off device with proof of use for this purpose.
- Kitchen exhaust air ducts must not be connected to one another or to other ventilation ducts. Having a joint line for the room air and the kitchen exhaust within the kitchen and the connection of multiple extractor hoods in a kitchen to a shared exhaust line is permitted.
- Suitable grease filters or separating devices made of non-combustible materials are to be attached placed on or directly behind exhaust devices (hoods or ventilation ceilings). It must be possible to remove and reattach these easily for cleaning.

- The exhaust ducts must have smooth, easy-to-clean interior surfaces. Profiled walls, such as flexible ducts and porous or absorbent materials are not permitted. Neither fat nor condensate must be able to pass through the walls.

- The exhaust ducts must have a cleaning opening after every change of direction and in horizontal, straight sections at intervals of no more than 3 m. Their dimensions must have a duct cross-section of at least 3600 cm². Devices must be placed at suitable locations in the ducting to collect and discharge condensate and cleaning agents.

■ Fire protection to neighbouring buildings

If there is a ventilation system on the building envelope (wall), the parts of the ventilation system must have fire-resistant L90 lining. This also applies to fans and their exhaust lines, which are guided outwardly up through the roof.

■ Fire protection in the roof space

Parts of the ventilation system (fan) in the roof space must have fire-resistant L90 lining. Lines that lead to the outdoors must have this lining up to the roof panels. Ventilation ducts (in the building and roof space) must have fire-resistant lining.



- In the GigaBox T120 range, the motor is located outside the delivery flow and is separated from the impeller by a heat-insulated wall. The motor impeller unit can be removed without dismantling the ducting system.



- Assembly of the shaped piece on exhaust side with GB T120 centrifugally above or at the side.



- GB T120 with easy-to-remove access panel.

By combining the parameters of static pressure increase ΔP_{fa} , radiated noise and intake air noise as sound pressure at 4 m

(free field conditions), the following table facilitates the selection of GigaBox centrifugal fans.

Type GB EC	Sound press. case breakout	Sound press. intake	Air flow volume $V_{m^3/h}$ depending on static pressure												
	L _{PA} dB(A)	L _{PA} dB(A)	(ΔP_{fa}) in Pa												
	at 4 m	at 4 m	0	50	100	150	200	250	300	350	400	500	600	700	800
GBW EC 250	31	43	2010	1880	1750	1600	1360	1010							
GBW EC 315	32	44	2620	2460	2310	2130	1830	1500							
GBW EC 355	30	49	3440	3270	3120	2950	2740	2500	2135	1630					
GBW EC 400 A	36	48	4050	3860	3600	3350	3050	2670	1880						
GBW EC 400 B	37	52	5160	4970	4730	4550	4210	4100	3800	3410	2900				
GBW EC 450	38	55	6460	6280	6100	5890	5660	5450	5190	4870	4600	3810			
GBD EC 450	39	56	7300	7120	6870	6650	6390	6110	5800	5500	5180	4420	3070		
GBD EC 500 A	43	55	8280	7980	7700	7380	7000	6620	6170	5680	5070	1800			
GBD EC 500 B	46	59	10500	10260	9980	9730	9410	9100	8850	8600	8320	7600	6650	5300	
GBD EC 560	49	59	13370	13110	12800	12510	12190	11930	11610	11280	10920	10310	9580	8320	6700
GBD EC 630	44	60	15000	14680	14200	13870	13450	12930	12380	11900	11310	10180	7850		
GBD EC 710 A	42	53	15890	15020	14250	13500	12510	11670	10680	9500	6730				
GBD EC 710 B	48	61	19630	19060	18400	16760	17130	16460	15720	15050	14060	11910	6960		

Type GB	Sound press. case breakout	Sound press. intake	Air flow volume $V_{m^3/h}$ depending on static pressure												
	L _{PA} dB(A)	L _{PA} dB(A)	(ΔP_{fa}) in Pa												
	at 4 m	at 4 m	0	50	100	150	200	250	300	350	400	500	600	700	800
GBW 250/4	27	39	1420	1160	890	500									
GBW 315/4	29	41	1760	1500	1260	970	560								
GBW 355/4	38	48	3060	2850	2640	2420	2180	1900	1510	560					
GBD 355/4/4	34	46	3090	2910	2720	2520	2290	2030	1680	1000					
GBW 400/4	38	50	4120	3920	3720	3500	3270	3000	2690	2260	1440				
GBD 400/4/4	38	50	4120	3910	3710	3500	3290	3050	2780	2430	1870				
GBW 450/4	40	49	4610	4400	4200	3990	3770	3530	3270	2970	2610				
GBD 450/4/4	40	52	5500	5220	4930	4640	4330	4000	3640	3210	2670				
GBW 500/4	47	59	8320	8020	7740	7460	7180	6910	6630	6340	6030	5330	4340	370	
GBD 500/4/4	45	57	8860	8540	8220	7880	7530	7160	6770	6350	5900	4800	2940	140	
GBW 560/4	45	57	9150	8910	8670	8420	8160	7890	7620	7330	7030	6360	5570	4500	2270
GBD 560/4/4	44	57	12610	12260	11910	11560	11200	10830	10450	10050	9630	8690	7540	5950	2940
GBD 560/6/6	35	48	8670	8160	7600	6990	6280	5410	4210	2190					
GBD 630/4/4	51	62	14430	14070	13710	13370	13040	12720	12390	12050	11710	11000	10200	9280	8110
GBD 630/6/6	42	53	9990	9430	8870	8290	7670	6980	6160	5070	3020				
GBD 710/4	46	59	20280	20020	19760	19490	19210	18930	18640	18340	18040	17400	16730	15990	15190
GBD 710/6/6	51	62	18740	17980	17190	16360	15490	14560	13550	12440	11170	7730	970		

Type GB T120	Sound press. case breakout	Sound press. intake	Air flow volume $V_{m^3/h}$ depending on static pressure												
	L _{PA} dB(A)	L _{PA} dB(A)	(ΔP_{fa}) in Pa												
	at 4 m	at 4 m	0	100	200	300	400	500	600	700	800	900	1000	1100	1200
GBW 355/4 T120	36	49	3460	2990	2460	1505									
GBD 355/4/4 T120	36	49	3470	3045	2510	1690									
GBW 400/4 T120	40	53	4930	4380	3790	2900	1580								
GBD 400/4/4 T120	40	53	4870	4295	3650	2740	1370								
GBW 450/4 T120	45	57	7110	6480	5850	5135	4350	3300	1900						
GBD 450/4/4 T120	45	57	7180	6600	5950	5220	4340	3230	1340						
GBW 500/4 T120	45	59	8345	7770	7160	6480	5670	4680	3510	1840					
GBD 500/4/4 T120	45	59	8350	7765	7490	7180	6600	5910	4970	3820	1920				
GBD 560/4/4 T120	48	62	12300	11690	11080	10475	9800	9120	8410	7430	6000				
GBD 630/4 T120	53	67	14140	13690	13200	12720	12230	11670	11150	10470	8830	7850	6820	5150	
GBD 710/4 T120	55	66	18200	17650	17200	16650	16000	15300	14500	13750	12800	11850	10850	9800	8500

GB EC

Arbitrary installation position and assembly in five possible discharge directions.

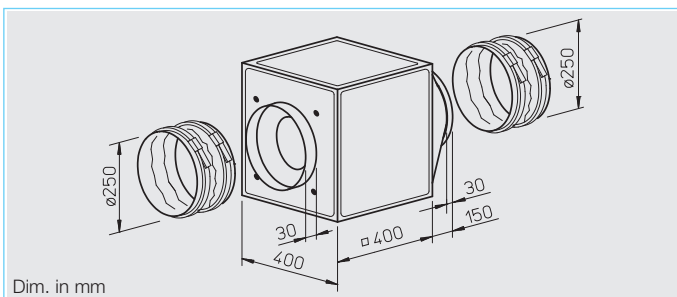
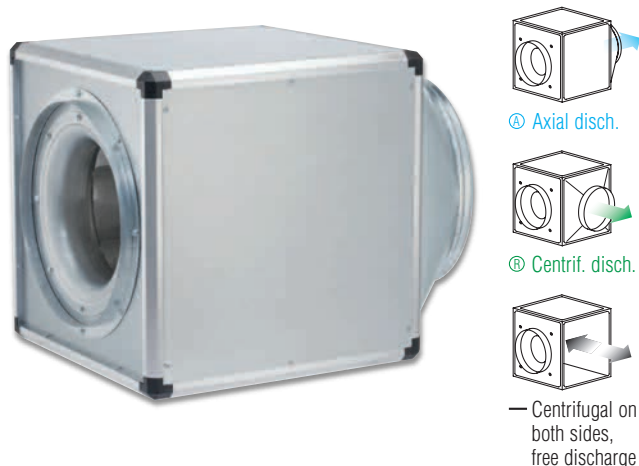

■ Specification

■ Casing

Self-supporting frame construction made from hollow aluminium profiles. Lined with 20 mm thick double-walled side panels made from galvanised sheet steel, sound and thermally insulated with flame-retardant mineral wool. Intake cone for ideal airflow, spigot and flexible connector for duct connection. With discharge adapter (from square to circular) on the pressure side for low-loss discharge and flexible sleeve to reduce vibration transmission. Simple positioning with standard crane hooks.

□ Impeller

Free-running backward curved centrifugal impeller from aluminium, direct driven. Energy efficient with a low noise development. Dynamically balanced together with the motor to DIN ISO 1940 Pt.1 – class 6.3.

□ Motor

Energy saving, speed controllable EC-external rotor motors with highest efficiency, protection to IP 54. With ball bearings, maintenance-free and interference-free.

□ Electrical connection

Standard terminal box (IP 54) is mounted with a permanently attached cable.

□ Motor protection

Integrated electronic temperature monitoring for EC motor and electronics.

□ Speed control

Stepless speed control with potentiometer or stepless speed control with universal control system (see table). Duties at different speeds are exemplarily given in the performance curve.

GBW EC 250

Frequency	Hz	Total	125	250	500	1k	2k	4k	8k
L _{WA} Case breakout		dB(A) 51	41	48	44	41	39	36	29
L _{WA} Intake		dB(A) 63	44	54	56	58	57	52	45
L _{WA} Exhaust		dB(A) 67	45	57	59	62	62	56	50

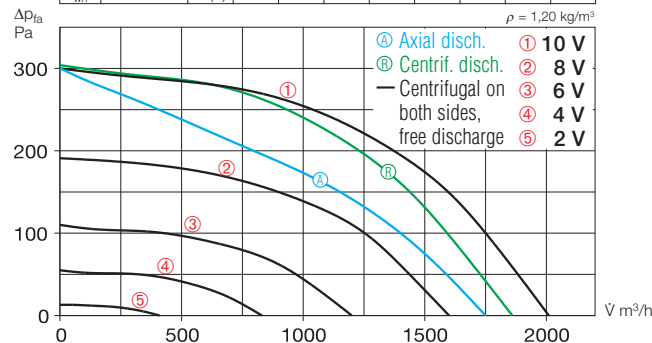

Free discharge						
Voltage V	n min ⁻¹	V̇ m³/h	P W	I A	Lp dB(A)	SFP kW/m³/s
10	1650	2010	120	0,79	31	0,22
8	1325	1600	70	0,46	28	0,15
6	1000	1200	35	0,25	22	0,11
4	710	830	21	0,18	17	0,09



EC box fans

■ Accessories

Anti vibration mounts for installation indoors. 1 set = 4 pcs.

SDD-U Ref. no. 5627

Wall bracket for wall mounting.

GB-WK 250 Ref. no. 5625

External weather louvre to cover exhaust opening.

GB-WSG 250 Ref. no. 5637

Outdoor cover hood for protected outdoor installation.

GB-WSD 250 Ref. no. 5746

Condensate collector with condensate spigot (centre) for pipe connection.

GB-KW 250 Ref. no. 5642

■ Accessory details Page

Universal control system, electronic controller, speed-potentiometer	539 on
--	--------

Type	Ref. no.	Connection Ø	Air flow volume (FID)	R.P.M.	Sound press. case breakout	Motor power	Current	Wiring diagram	max. air flow temperature	Weight net approx.	Universal control system	Speed-potentiometer flush	Speed-potentiometer surface
		mm	V m³/h	min ⁻¹	dB(A) in 4 m	kW	A	No.	+ °C	kg	Type Ref. no.	Type Ref. no.	Type Ref. no.
Single phase motor, 1~, 230 V, 50/60 Hz, EC motor, protection to IP 54													
GBW EC 250	5807	250	2010	1650	31	0.17	1.05	973	55	20.0	EUR EC 1 ²⁾ 1347	PU 24 1 ¹⁾ 1736	PA 24 1 ¹⁾ 1737

1) several EC fans can normally be connected 2) alternative electronic differential pressure/temp. controller (EDR/ETR, No. 1437/1438) or three-step speed switch (SU/SA, No. 4266/4267), see accessories

GB EC

Arbitrary installation position and assembly in five possible discharge directions.

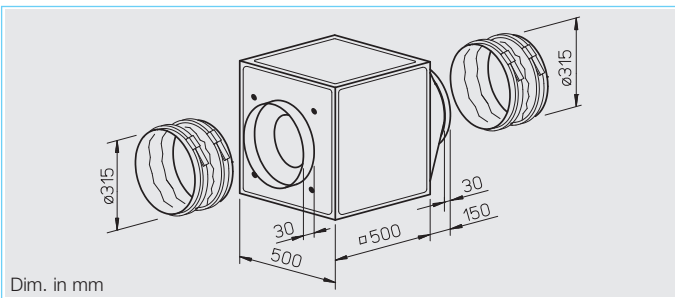
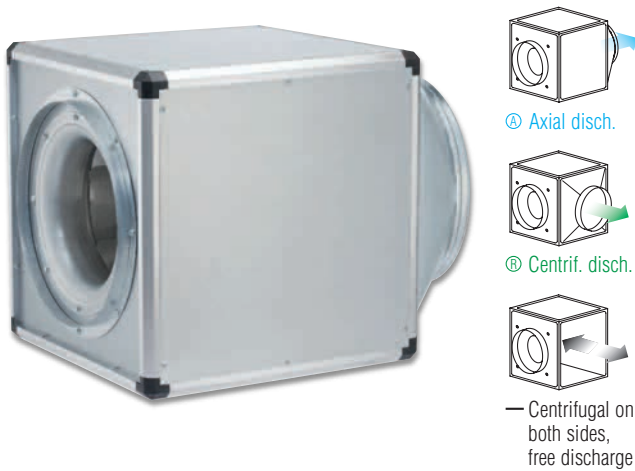

■ Specification

■ Casing

Self-supporting frame construction made from hollow aluminium profiles. Lined with 20 mm thick double-walled side panels made from galvanised sheet steel, sound and thermally insulated with flame-retardant mineral wool. Intake cone for ideal airflow, spigot and flexible connector for duct connection. With discharge adapter (from square to circular) on the pressure side for low-loss discharge and flexible sleeve to reduce vibration transmission. Simple positioning with standard crane hooks.

□ Impeller

Free-running backward curved centrifugal impeller from aluminium, direct driven. Energy efficient with a low noise development. Dynamically balanced together with the motor to DIN ISO 1940 Pt.1 – class 6.3.

□ Motor

Energy saving, speed controllable EC-external rotor motors with highest efficiency, protection to IP 54. With ball bearings, maintenance-free and interference-free.

□ Electrical connection

Standard terminal box (IP 54) is mounted with a permanently attached cable.

□ Motor protection

Integrated electronic temperature monitoring for EC motor and electronics.

□ Speed control

Stepless speed control with potentiometer or stepless speed control with universal control system (see table). Duties at different speeds are exemplarily given in the performance curve.

GBW EC 315

Frequency	Hz	Total	125	250	500	1k	2k	4k	8k
L _{WA} Case breakout	dB(A)	52	38	46	46	46	45	43	32
L _{WA} Intake	dB(A)	64	43	56	57	58	58	54	44
L _{WA} Exhaust	dB(A)	69	48	58	63	65	65	59	51

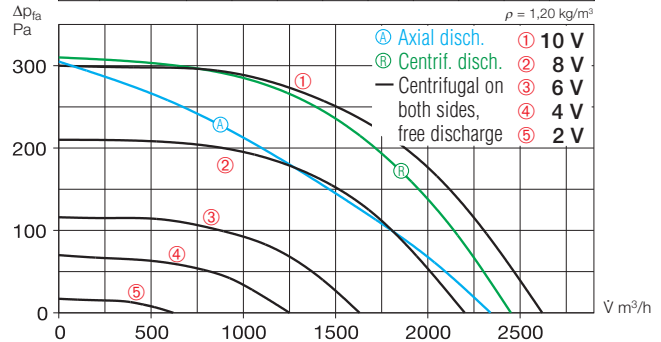

Free discharge						
Voltage V	n min ⁻¹	V m³/h	P W	I A	Lp dB(A)	SFP kW/m²/s
10	1500	2620	142	0,91	32	0,20
8	1250	2200	85	0,58	29	0,14
6	930	1630	42	0,31	24	0,09
4	710	1250	25	0,19	20	0,07



■ Accessories

Anti vibration mounts for installation indoors. 1 set = 4 pcs.

SDD-U Ref. no. 5627

Wall bracket for wall mounting.

GB-WK 315 Ref. no. 5625

External weather louvre to cover exhaust opening.

GB-WSG 315 Ref. no. 5638

Outdoor cover hood for protected outdoor installation.

GB-WSD 315 Ref. no. 5747

Condensate collector with condensate spigot (centre) for pipe connection.

GB-KW 315 Ref. no. 5643

■ Accessory details Page

Universal control system, electronic controller, speed-potentiometer 539 on

Type	Ref. no.	Connection Ø	Air flow volume (FID)	R.P.M.	Sound press. case breakout	Motor power	Current	Wiring diagram	max. air flow temperature	Weight net approx.	Universal control system	Speed-potentiometer flush	Speed-potentiometer surface
		mm	V m³/h	min ⁻¹	dB(A) in 4 m	kW	A	No.	+ °C	kg	Type Ref. no.	Type Ref. no.	Type Ref. no.
Single phase motor, 1~, 230 V, 50/60 Hz, EC motor, protection to IP 54													
GBW EC 315	5808	315	2620	1500	32	0.20	1.25	973	55	31.0	EUR EC 1²⁾ 1347	PU 24¹⁾ 1736	PA 24¹⁾ 1737

1) several EC fans can normally be connected 2) alternative electronic differential pressure/temp. controller (EDR/ETR, No. 1437/1438) or three-step speed switch (SU/SA, No. 4266/4267), see accessories

GB EC

Arbitrary installation position and assembly in five possible discharge directions.

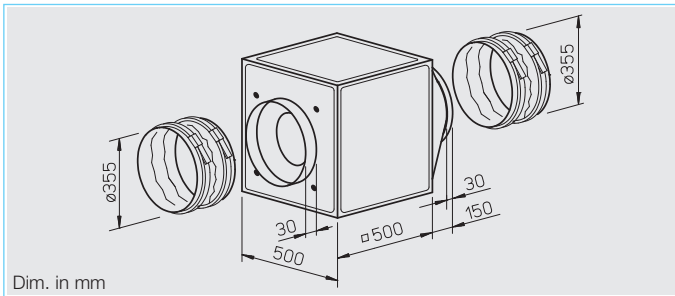
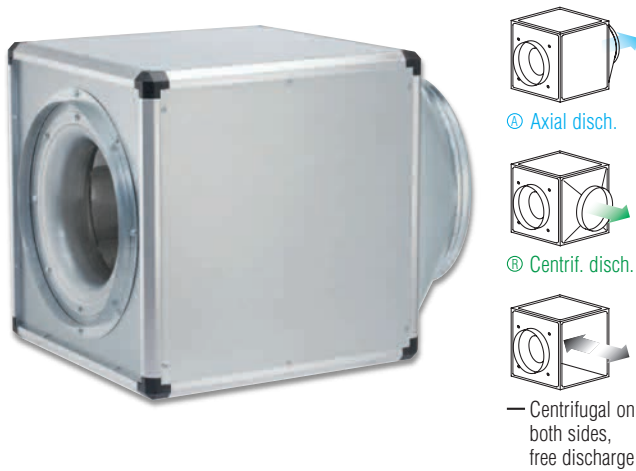

■ Specification

■ Casing

Self-supporting frame construction made from hollow aluminium profiles. Lined with 20 mm thick double-walled side panels made from galvanised sheet steel, sound and thermally insulated with flame-retardant mineral wool. Intake cone for ideal airflow, spigot and flexible connector for duct connection. With discharge adapter (from square to circular) on the pressure side for low-loss discharge and flexible sleeve to reduce vibration transmission. Simple positioning with standard crane hooks.

□ Impeller

Free-running backward curved centrifugal impeller from aluminium, direct driven. Energy efficient with a low noise development. Dynamically balanced together with the motor to DIN ISO 1940 Pt.1 – class 6.3.

□ Motor

Energy saving, speed controllable EC-external rotor motors with highest efficiency, protection to IP 54. With ball bearings, maintenance-free and interference-free.

□ Electrical connection

Standard terminal box (IP 54) is mounted with a permanently attached cable.

□ Motor protection

Integrated electronic temperature monitoring for EC motor and electronics.

□ Speed control

Stepless speed control with potentiometer or stepless speed control with universal control system (see table). Duties at different speeds are exemplarily given in the performance curve.

GBW EC 355

Frequency	Hz	Total	125	250	500	1k	2k	4k	8k
L _{WA} Case breakout		dB(A) 50	45	44	39	42	41	38	29
L _{WA} Intake		dB(A) 69	49	63	65	62	59	55	48
L _{WA} Exhaust		dB(A) 72	52	64	68	66	63	58	51

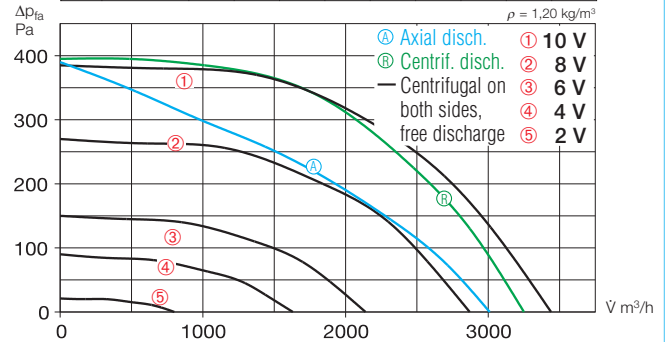

Free discharge						
Voltage V	n min ⁻¹	V̇ m³/h	P W	I A	Lp dB(A)	SFP kW/m³/s
10	1500	3440	235	1,40	30	0,25
8	1250	2870	140	0,87	27	0,17
6	930	2140	64	0,45	22	0,11
4	710	1630	34	0,26	18	0,08



■ Accessories

Anti vibration mounts for installation indoors. 1 set = 4 pcs.

SDD-U Ref. no. 5627

Wall bracket for wall mounting.

GB-WK 355 Ref. no. 5625

External weather louvre to cover exhaust opening.

GB-WSG 355 Ref. no. 5638

Outdoor cover hood for protected outdoor installation.

GB-WSD 355 Ref. no. 5747

Condensate collector with condensate spigot (centre) for pipe connection.

GB-KW 355 Ref. no. 5643

■ Accessory details Page

Universal control system, electronic controller, speed-potentiometer	539 on
--	--------

Type	Ref. no.	Connection Ø	Air flow volume (FID)	R.P.M.	Sound press. case breakout	Motor power	Current	Wiring diagram	max. air flow temperature	Weight net approx.	Universal control system	Speed-potentiometer flush	Speed-potentiometer surface
		mm	V m³/h	min ⁻¹	dB(A) in 4 m	kW	A	No.	+ °C	kg	Type Ref. no.	Type Ref. no.	Type Ref. no.
Single phase motor, 1~, 230 V, 50/60 Hz, EC motor, protection to IP 54													
GBW EC 355	5809	355	3440	1500	30	0.35	2.10	973	50	33.0	EUR EC 1 ²⁾ 1347	PU 24 1 ¹⁾ 1736	PA 24 1 ¹⁾ 1737

1) several EC fans can normally be connected 2) alternative electronic differential pressure/temp. controller (EDR/ETR, No. 1437/1438) or three-step speed switch (SU/SA, No. 4266/4267), see accessories

GB EC

Arbitrary installation position and assembly in five possible discharge directions.

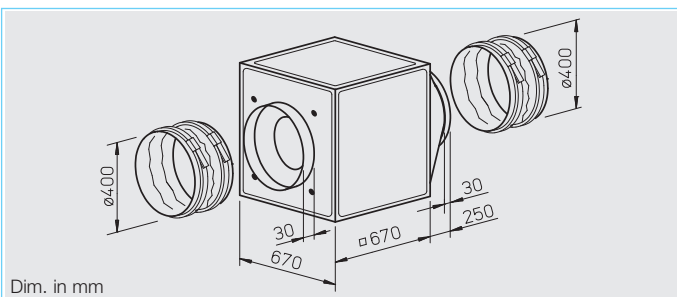
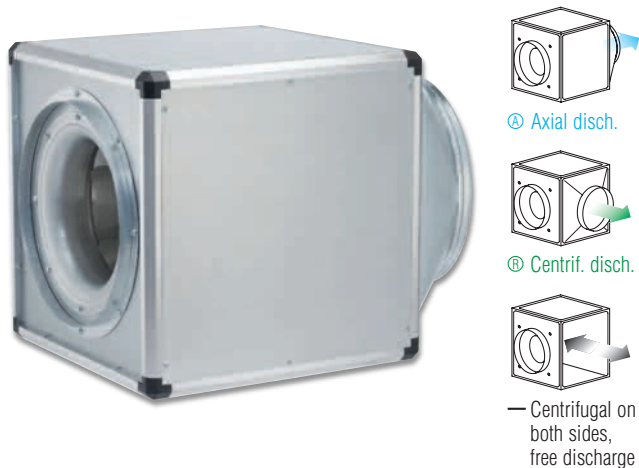

■ Specification
■ Casing

Self-supporting frame construction made from hollow aluminium profiles. Lined with 20 mm thick double-walled side panels made from galvanised sheet steel, sound and thermally insulated with flame-retardant mineral wool. Intake cone for ideal airflow, spigot and flexible connector for duct connection. With discharge adapter (from square to circular) on the pressure side for low-loss discharge and flexible sleeve to reduce vibration transmission. Simple positioning with standard crane hooks.

□ Impeller

Impeller and remaining design see description on page 241.

■ Accessories

Anti vibration mounts for installation indoors. 1 set = 4 pcs.
SDD-U Ref. no. 5627

Wall bracket for wall mounting.
GB-WK 400 Ref. no. 5626

External weather louvre to cover exhaust opening.
GB-WSG 400 Ref. no. 5639

Outdoor cover hood for protected outdoor installation.
GB-WSD 400 Ref. no. 5748

Condensate collector with condensate spigot (centre) for pipe connection.
GB-KW 400 Ref. no. 5644

GBW EC 400 A

Frequency	Hz	Total	125	250	500	1k	2k	4k	8k
L _{WA} Case breakout		dB(A) 56	52	52	47	43	40	35	27
L _{WA} Intake		dB(A) 68	53	62	67	60	58	55	48
L _{WA} Exhaust		dB(A) 71	61	62	64	67	62	57	48

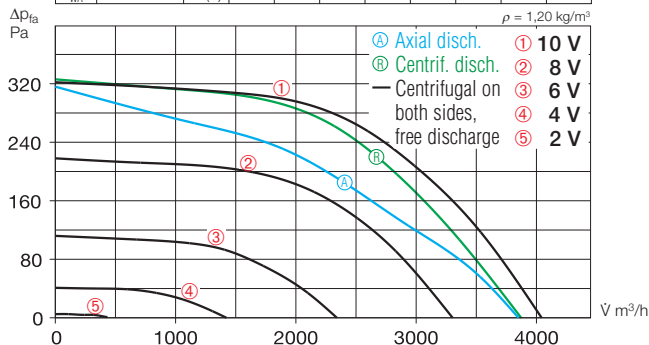

Free discharge						
Voltage V	n min ⁻¹	V̇ m³/h	P W	I A	Lp dB(A)	SFP kW/m²/s
10	1200	4040	209	1,2	36	0,19
8	990	3300	118	0,7	32	0,13
6	710	2340	49	0,3	25	0,08
4	430	1420	21	0,2	18	0,05

GBW EC 400 B

Frequency	Hz	Total	125	250	500	1k	2k	4k	8k
L _{WA} Case breakout		dB(A) 57	46	54	49	48	46	43	39
L _{WA} Intake		dB(A) 72	53	64	65	66	67	59	53
L _{WA} Exhaust		dB(A) 76	56	67	70	71	70	62	55

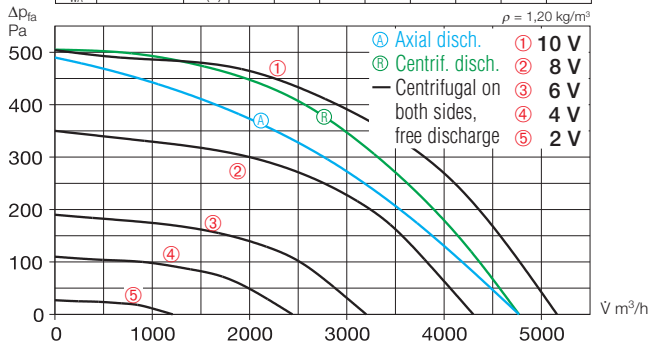

Free discharge						
Voltage V	n min ⁻¹	V̇ m³/h	P W	I A	Lp dB(A)	SFP kW/m²/s
10	1500	5160	395	2,52	37	0,28
8	1250	4300	244	1,63	34	0,21
6	930	3200	117	0,85	29	0,13
4	710	2440	63	0,49	25	0,09



Accessory details	Page
Universal control system, electronic controller, speed-potentiometer	539 on

Type	Ref. no.	Connection Ø	Air flow volume (FID)	R.P.M.	Sound press. case breakout	Motor power	Current	Wiring diagram	max. air flow temperature	Weight net approx.	Universal control system	Speed-potentiometer flush	Speed-potentiometer surface
		mm	V̇ m³/h	min ⁻¹	dB(A) in 4 m	kW	A	No.	+ °C	kg	Type Ref. no.	Type Ref. no.	Type Ref. no.
Single phase motor, 1~, 230 V, 50/60 Hz, EC motor, protection to IP 54													
GBW EC 400 A	5817	400	4050	1200	36	0.35	2.00	973	50	43.0	EUR EC ^{1) 2)} 1347	PU 24 ¹⁾ 1736	PA 24 ¹⁾ 1737
GBW EC 400 B	5810	400	5160	1500	37	0.62	3.70	976	50	46.0	EUR EC ^{1) 2)} 1347	PU 24 ¹⁾ 1736	PA 24 ¹⁾ 1737

1) several EC fans can normally be connected 2) alternative electronic differential pressure/temp. controller (EDR/ETR, No. 1437/1438) or three-step speed switch (SU/SA, No. 4266/4267), see accessories

GB EC

Arbitrary installation position and assembly in five possible discharge directions.

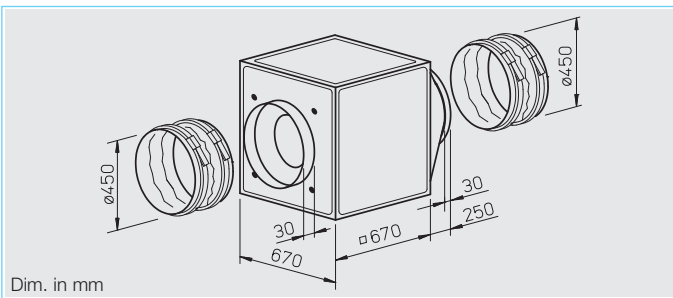
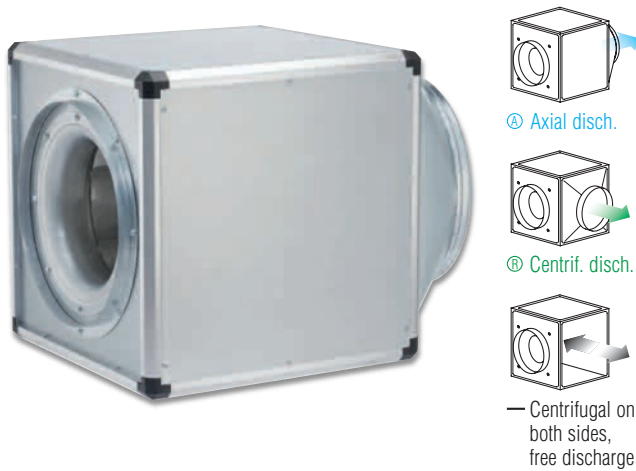

■ Specification ■ Casing

Self-supporting frame construction made from hollow aluminium profiles. Lined with 20 mm thick double-walled side panels made from galvanised sheet steel, sound and thermally insulated with flame-retardant mineral wool. Intake cone for ideal airflow, spigot and flexible connector for duct connection. With discharge adapter (from square to circular) on the pressure side for low-loss discharge and flexible sleeve to reduce vibration transmission. Simple positioning with standard crane hooks.

□ Impeller

Impeller and remaining design see description on page 241.

■ Accessories

Anti vibration mounts for installation indoors. 1 set = 4 pcs.

SDD-U Ref. no. 5627

Wall bracket for wall mounting.

GB-WK 450 Ref. no. 5626

External weather louvre to cover exhaust opening.

GB-WSG 450 Ref. no. 5639

Outdoor cover hood for protected outdoor installation.

GB-WSD 450 Ref. no. 5748

Condensate collector with condensate spigot (centre) for pipe connection.

GB-KW 450 Ref. no. 5644

GBW EC 450

Frequency	Hz	Total	125	250	500	1k	2k	4k	8k
L _{WA} Case breakout		dB(A) 58	48	56	48	47	46	42	31
L _{WA} Intake		dB(A) 75	54	66	68	70	69	64	57
L _{WA} Exhaust		dB(A) 79	60	70	74	75	74	65	60

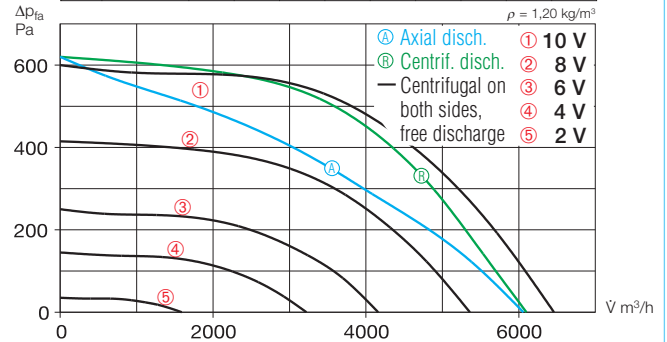

Free discharge						
Voltage V	n min ⁻¹	V̇ m³/h	P W	I A	Lp dB(A)	SFP kW/m³/s
10	1450	6460	614	3,71	38	0,34
8	1200	5360	363	2,35	35	0,24
6	930	4160	185	1,27	31	0,16
4	710	3220	92	0,68	26	0,10

GBD EC 450

Frequency	Hz	Total	125	250	500	1k	2k	4k	8k
L _{WA} Case breakout		dB(A) 59	49	57	49	48	47	43	32
L _{WA} Intake		dB(A) 76	55	67	69	71	70	65	58
L _{WA} Exhaust		dB(A) 80	61	71	75	76	75	66	61

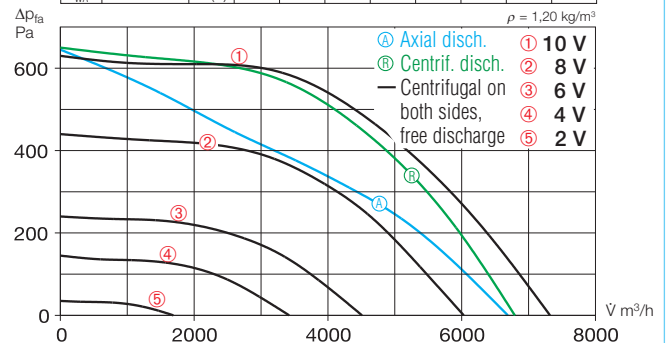

Free discharge						
Voltage V	n min ⁻¹	V̇ m³/h	P W	I A	Lp dB(A)	SFP kW/m³/s
10	1500	7320	640	1,20	39	0,31
8	1250	6030	380	0,80	36	0,23
6	930	4510	170	0,45	31	0,14
4	710	3420	90	0,27	28	0,10



■ Accessory details Page

Universal control system, electronic controller, speed-potentiometer 539 on

Type	Ref. no.	Connection Ø	Air flow volume (FID)	R.P.M.	Sound press. case breakout	Motor power	Current	Wiring diagram	max. air flow temperature	Weight net approx.	Universal control system	Speed-potentiometer flush	Speed-potentiometer surface
		mm	V m³/h	min ⁻¹	dB(A) in 4 m	kW	A	No.	+ °C	kg	Type Ref. no.	Type Ref. no.	Type Ref. no.
Single phase motor, 1~, 230 V, 50/60 Hz, EC motor, protection to IP 54													
GBW EC 450	5811	450	6460	1450	38	1.00	5.70	976	50	55.0	EUR EC ^{1) 2)} 1347	PU 24 ¹⁾ 1736	PA 24 ¹⁾ 1737
Three phase motor, 3~, 400 V, 50/60 Hz, EC motor, protection to IP 54													
GBD EC 450	5812	450	7320	1500	39	1.00	1.80	976	55	52.0	EUR EC ^{1) 2)} 1347	PU 24 ¹⁾ 1736	PA 24 ¹⁾ 1737

1) several EC fans can normally be connected 2) alternative electronic differential pressure/temp. controller (EDR/ETR, No. 1437/1438) or three-step speed switch (SU/SA, No. 4266/4267), see accessories

GB EC

Arbitrary installation position and assembly in five possible discharge directions.

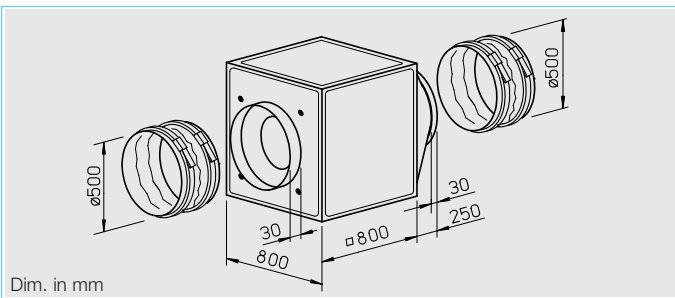
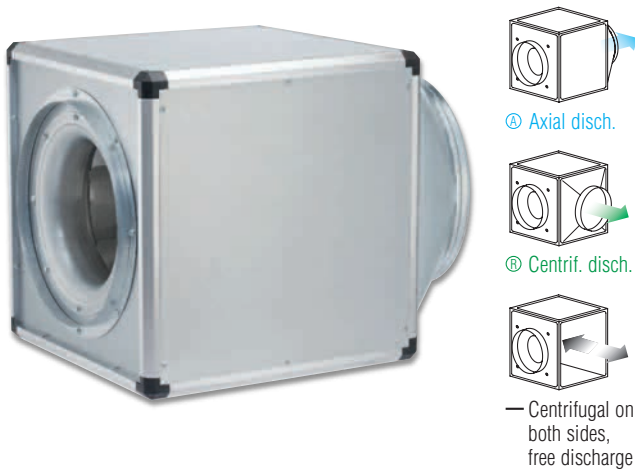

■ Specification
■ Casing

Self-supporting frame construction made from hollow aluminium profiles. Lined with 20 mm thick double-walled side panels made from galvanised sheet steel, sound and thermally insulated with flame-retardant mineral wool. Intake cone for ideal airflow, spigot and flexible connector for duct connection. With discharge adapter (from square to circular) on the pressure side for low-loss discharge and flexible sleeve to reduce vibration transmission. Simple positioning with standard crane hooks.

□ Impeller

Impeller and remaining design see description on adjacent page.

■ Accessories

Anti vibration mounts for installation indoors. 1 set = 4 pcs.
SDD-U Ref. no. 5627

Wall bracket for wall mounting.
GB-WK 500 Ref. no. 5626

External weather louvre to cover exhaust opening.
GB-WSG EC500 Ref. no. 5640

Outdoor cover hood for protected outdoor installation.
GB-WSD EC500 Ref. no. 5749

Condensate collector with condensate spigot (centre) for pipe connection.
GB-KW EC500 Ref. no. 5645

GBD EC 500 A

Frequency	Hz	Total	125	250	500	1k	2k	4k	8k
L _{WA} Case breakout		dB(A) 63	57	60	55	54	45	39	31
L _{WA} Intake		dB(A) 75	57	66	66	69	68	66	59
L _{WA} Exhaust		dB(A) 78	61	66	70	74	72	68	60

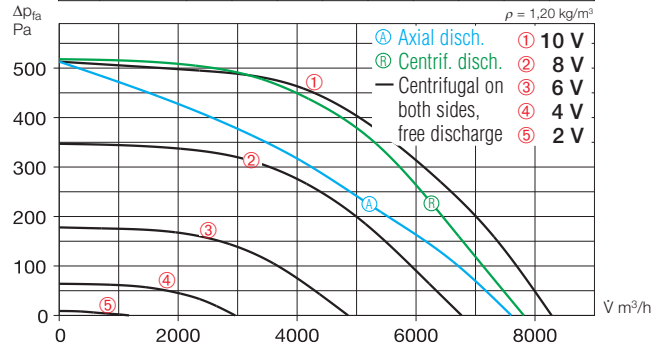

Free discharge						
Voltage V	n min ⁻¹	V̇ m ³ /h	P W	I A	Lp dB(A)	SFP kW/m ² /s
10	1200	8280	701	1.20	43	0,30
8	990	6770	414	0,75	39	0,22
6	710	4860	190	0,37	32	0,14
4	430	2960	63	0,16	22	0,08

GBD EC 500 B

Frequency	Hz	Total	125	250	500	1k	2k	4k	8k
L _{WA} Case breakout		dB(A) 66	56	65	58	57	53	50	43
L _{WA} Intake		dB(A) 79	58	70	72	74	73	68	61
L _{WA} Exhaust		dB(A) 82	62	73	76	77	75	71	64

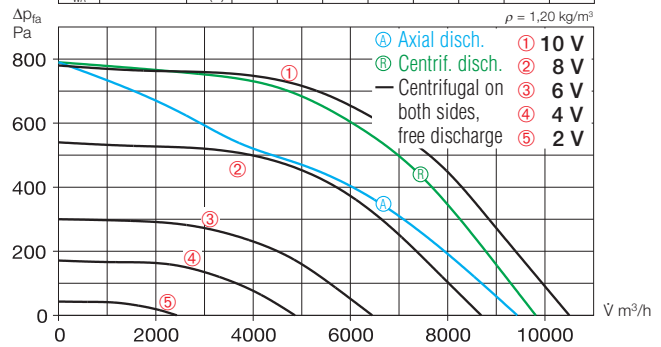

Free discharge						
Voltage V	n min ⁻¹	V̇ m ³ /h	P W	I A	Lp dB(A)	SFP kW/m ² /s
10	1500	10500	1250	2,10	46	0,43
8	1250	8690	745	1,30	43	0,31
6	930	6450	300	0,60	38	0,17
4	710	4860	170	0,40	34	0,13



Accessory details	Page
Universal control system, electronic controller, speed-potentiometer	539 on

Type	Ref. no.	Connection Ø	Air flow volume (FID)	R.P.M.	Sound press. case breakout	Motor power	Current	Wiring diagram	max. air flow temperature	Weight net approx.	Universal control system	Speed-potentiometer flush	Speed-potentiometer surface
		mm	V̇ m ³ /h	min ⁻¹	dB(A) in 4 m	kW	A	No.	+ °C	kg	Type Ref. no.	Type Ref. no.	Type Ref. no.
Three phase motor, 3~, 400 V, 50/60 Hz, EC motor, protection to IP 54													
GBD EC 500 A	5818	500	8280	1200	43	1.10	1.80	976	50	80.5	EUR EC ^{1) 2)} 1347	PU 24 ¹⁾ 1736	PA 24 ¹⁾ 1737
GBD EC 500 B	5813	500	10500	1500	46	1.95	3.10	976	50	79.0	EUR EC ^{1) 2)} 1347	PU 24 ¹⁾ 1736	PA 24 ¹⁾ 1737

1) several EC fans can normally be connected 2) alternative electronic differential pressure/temp. controller (EDR/ETR, No. 1437/1438) or three-step speed switch (SU/SA, No. 4266/4267), see accessories

GB EC

Arbitrary installation position and assembly in five possible discharge directions.

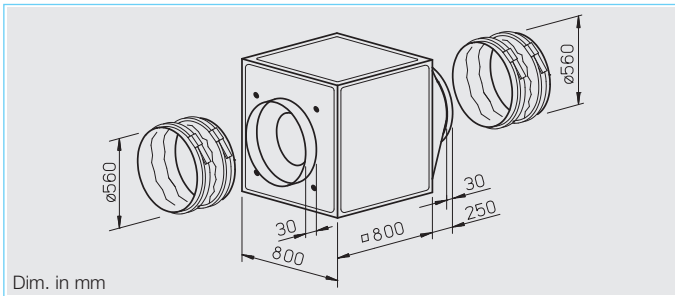
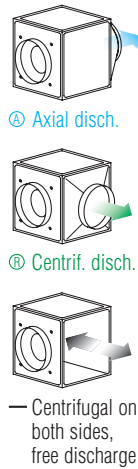

Specification

Casing

Self-supporting frame construction made from hollow aluminium profiles. Lined with 20 mm thick double-walled side panels made from galvanised sheet steel, sound and thermally insulated with flame-retardant mineral wool. Intake cone for ideal airflow, spigot and flexible connector for duct connection. With discharge adapter (from square to circular) on the pressure side for low-loss discharge and flexible sleeve to reduce vibration transmission. Simple positioning with standard crane hooks.

Impeller

Free-running backward curved centrifugal impeller from aluminium, direct driven. Energy efficient with a low noise development. Dynamically balanced together with the motor to DIN ISO 1940 Pt.1 – class 2.5.

Motor

Energy saving, speed controllable EC-external rotor motors with highest efficiency, protection to IP 54. With ball bearings, maintenance-free and interference-free.

Electrical connection

Standard terminal box (IP 54) is mounted with a permanently attached cable.

Motor protection

Integrated electronic temperature monitoring for EC motor and electronics.

Speed control

Stepless speed control with potentiometer or stepless speed control with universal control system (see table). Duties at different speeds are exemplarily given in the performance curve.

GBD EC 560

Frequency	Hz	Total	125	250	500	1k	2k	4k	8k
L _{WA} Case breakout		dB(A) 69	60	67	58	57	56	55	49
L _{WA} Intake		dB(A) 79	61	71	73	74	72	66	60
L _{WA} Exhaust		dB(A) 84	65	74	79	80	75	70	62

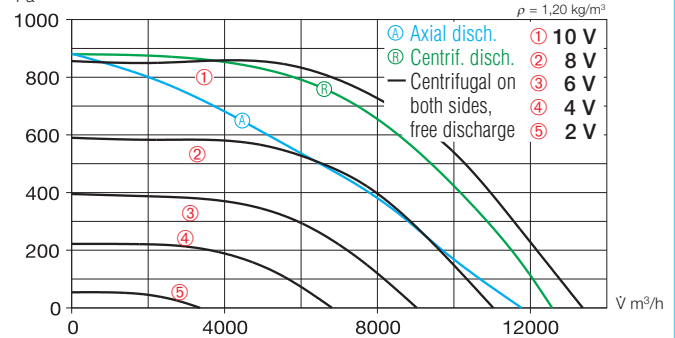

Free discharge						
Voltage V	n min ⁻¹	V̇ m³/h	P W	I A	Lp dB(A)	SFP kW/m³/s
10	1400	13370	1847	2,90	49	0,49
8	1150	11030	1030	1,70	46	0,34
6	930	9030	578	1,00	43	0,23
4	710	6810	281	0,55	39	0,15



Accessories

Anti vibration mounts for installation indoors. 1 set = 4 pcs.

SDD-U Ref. no. 5627

Wall bracket for wall mounting.

GB-WK 560 Ref. no. 5626

External weather louvre to cover exhaust opening.

GB-WSG 560 Ref. no. 5640

Outdoor cover hood for protected outdoor installation.

GB-WSD 560 Ref. no. 5749

Condensate collector with condensate spigot (centre) for pipe connection.

GB-KW 560 Ref. no. 5645

Accessory details Page

Universal control system, electronic controller, speed-potentiometer 539 on

Type	Ref. no.	Connection Ø	Air flow volume (FID)	R.P.M.	Sound press. case breakout	Motor power	Current	Wiring diagram	max. air flow temperature	Weight net approx.	Universal control system	Speed-potentiometer flush	Speed-potentiometer surface
		mm	V m³/h	min ⁻¹	dB(A) in 4 m	kW	A	No.	+ °C	kg	Type Ref. no.	Type Ref. no.	Type Ref. no.
Three phase motor, 3~, 400 V, 50/60 Hz, EC motor, protection to IP 54													
GBD EC 560	5814	560	13370	1400	49	2.80	4.30	976	50	83.0	EUR EC 1 ²⁾ 1347	PU 24 1 ¹⁾ 1736	PA 24 1 ¹⁾ 1737

1) several EC fans can normally be connected 2) alternative electronic differential pressure/temp. controller (EDR/ETR, No. 1437/1438) or three-step speed switch (SU/SA, No. 4266/4267), see accessories

GB EC

Arbitrary installation position and assembly in five possible discharge directions.

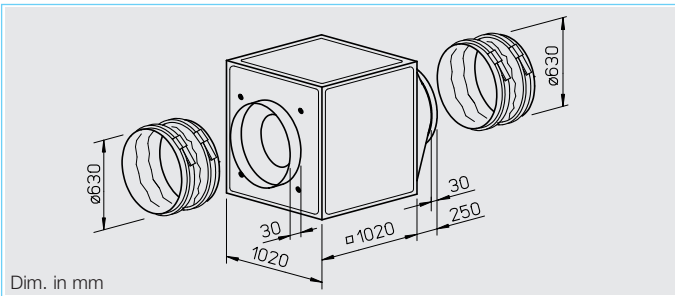
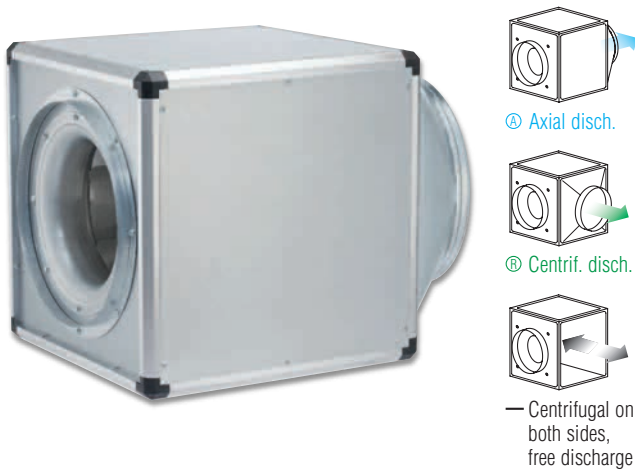

■ Specification

■ Casing

Self-supporting frame construction made from hollow aluminium profiles. Lined with 20 mm thick double-walled side panels made from galvanised sheet steel, sound and thermally insulated with flame-retardant mineral wool. Intake cone for ideal airflow, spigot and flexible connector for duct connection. With discharge adapter (from square to circular) on the pressure side for low-loss discharge and flexible sleeve to reduce vibration transmission. Simple positioning with standard crane hooks.

□ Impeller

Free-running backward curved centrifugal impeller from aluminium, direct driven. Energy efficient with a low noise development. Dynamically balanced together with the motor to DIN ISO 1940 Pt.1 – class 2.5.

□ Motor

Energy saving, speed controllable EC-external rotor motors with highest efficiency, protection to IP 54. With ball bearings, maintenance-free and interference-free.

□ Electrical connection

Standard terminal box (IP 54) is mounted with a permanently attached cable.

□ Motor protection

Integrated electronic temperature monitoring for EC motor and electronics.

□ Speed control

Stepless speed control with potentiometer or stepless speed control with universal control system (see table). Duties at different speeds are exemplarily given in the performance curve.

GBD EC 630

Frequency	Hz	Total	125	250	500	1k	2k	4k	8k
L _{WA} Case breakout	dB(A)	64	58	61	53	51	49	41	
L _{WA} Intake	dB(A)	80	66	71	72	74	73	72	68
L _{WA} Exhaust	dB(A)	83	69	76	77	78	75	68	61

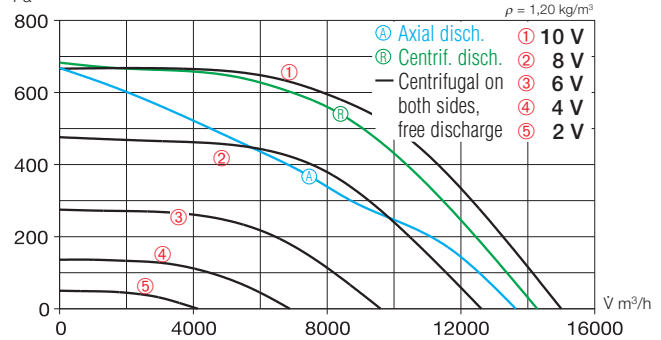

Free discharge						
Voltage V	n min ⁻¹	V̇ m³/h	P W	I A	Lp dB(A)	SFP kW/m²/s
10	1100	15000	1430	2,40	44	0,34
8	930	12610	890	1,50	42	0,25
6	710	9600	415	0,78	38	0,16
4	500	6880	170	0,36	32	0,09



□ Installation

Arbitrary installation position and flexible assembly by five possible discharge directions via the discharge adapter.

For wall mounting the wall bracket (accessories) has to be used. Outdoor installation is possible using outdoor cover hood and external weather louvres (accessories).

■ Sound levels

Total sound power levels and the spectrum figures in dB(A) are given for:

- Sound level case breakout
- Sound level intake
- Sound level exhaust

In the table below as well as underneath the performance curve you can find additionally the sound pressure levels at 4 m (free field conditions).

■ Accessories

Anti vibration mounts for installation indoors. 1 set = 4 pcs.

SDD-U Ref. no. 5627

External weather louvre to cover exhaust opening.

GB-WSG EC630 Ref. no. 5641

Outdoor cover hood for protected outdoor installation.

GB-WSD EC630 Ref. no. 5750

Condensate collector with condensate spigot (centre) for pipe connection.

GB-KW EC630 Ref. no. 5646

■ Accessory details Page

Universal control system, electronic controller, speed-potentiometer 539 on

Type	Ref. no.	Connection Ø	Air flow volume (FID)	R.P.M.	Sound press. case breakout	Motor power	Current	Wiring diagram	max. air flow temperature	Weight net approx.	Universal control system	Speed-potentiometer flush	Speed-potentiometer surface
		mm	V̇ m³/h	min ⁻¹	dB(A) in 4 m	kW	A	No.	+ °C	kg	Type Ref. no.	Type Ref. no.	Type Ref. no.
Three phase motor, 3~, 400 V, 50/60 Hz, EC motor, protection to IP 54													
GBD EC 630	5815	630	15000	1100	44	2.30	3.70	976	50	116.0	EUR EC 1²⁾ 1347	PU 24¹⁾ 1736	PA 24¹⁾ 1737

1) several EC fans can normally be connected 2) alternative electronic differential pressure/temp. controller (EDR/ETR, No. 1437/1438) or three-step speed switch (SU/SA, No. 4266/4267), see accessories

GB EC

Arbitrary installation position and assembly in five possible discharge directions.

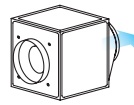

① Axial disch.

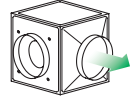

② Centrif. disch.

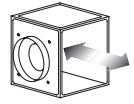

③ Centrifugal on both sides, free discharge

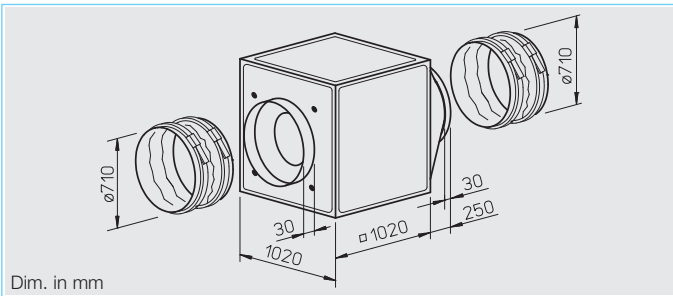

■ Specification

Casing
Self-supporting frame construction made from hollow aluminium profiles. Lined with 20 mm thick double-walled side panels made from galvanised sheet steel, sound and thermally insulated with flame-retardant mineral wool. Intake cone for ideal airflow, spigot and flexible connector for duct connection. With discharge adapter (from square to circular) on the pressure side for low-loss discharge and flexible sleeve to reduce vibration transmission. Simple positioning with standard crane hooks.

□ Impeller

Impeller and remaining design see description on adjacent page.

■ Accessories

Anti vibration mounts for installation indoors. 1 set = 4 pcs.

SDD-U Ref. no. 5627

External weather louvre to cover exhaust opening.

GB-WSG 710 Ref. no. 5641

Outdoor cover hood for protected outdoor installation.

GB-WSD 710 Ref. no. 5750

Condensate collector with condensate spigot (centre) for pipe connection.

GB-KW 710 Ref. no. 5646

■ Accessory details Page

Universal control system, electronic controller, speed-potentiometer 539 on

GBD EC 710 A

Frequency	Hz	Total	125	250	500	1k	2k	4k	8k
L _{WA} Case breakout		dB(A) 62	58	57	52	51	50	46	44
L _{WA} Intake		dB(A) 73	60	64	66	68	66	61	59
L _{WA} Exhaust		dB(A) 75	60	67	69	72	68	63	62

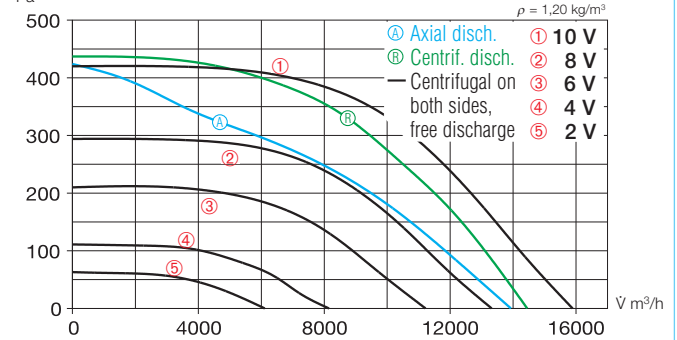

Free discharge						
Voltage V	n min ⁻¹	V̇ m ³ /h	P W	I A	Lp dB(A)	SFP kW/m ³ /s
10	775	15890	935	1,50	42	0,21
8	650	13320	561	1,00	40	0,15
6	550	11220	358	0,70	38	0,12
4	400	8150	158	0,34	33	0,07

GBD EC 710 B

Frequency	Hz	Total	125	250	500	1k	2k	4k	8k
L _{WA} Case breakout		dB(A) 68	65	64	54	53	51	47	41
L _{WA} Intake		dB(A) 81	62	74	75	75	73	70	61
L _{WA} Exhaust		dB(A) 85	65	74	77	82	76	72	63

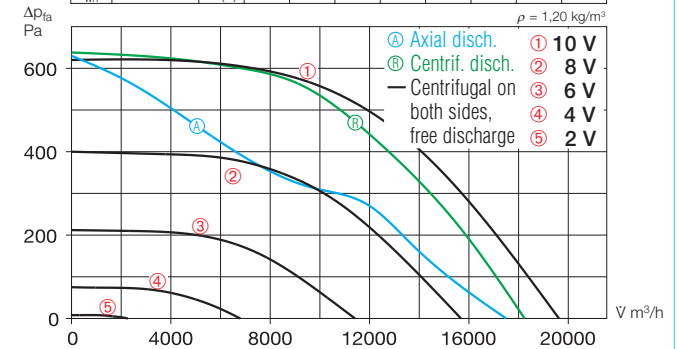

Free discharge						
Voltage V	n min ⁻¹	V̇ m ³ /h	P W	I A	Lp dB(A)	SFP kW/m ³ /s
10	940	19650	1700	2,70	48	0,31
8	750	15690	904	1,50	43	0,21
6	550	11420	393	0,80	36	0,12
4	330	6800	97	0,20	26	0,05



Type	Ref. no.	Connection Ø	Air flow volume (FID)	R.P.M.	Sound press. case breakout	Motor power	Current	Wiring diagram	max. air flow temperature	Weight net approx.	Universal control system	Speed-potentiometer flush	Speed-potentiometer surface
		mm	V m ³ /h	min ⁻¹	dB(A) in 4 m	kW	A	No.	+ °C	kg	Type Ref. no.	Type Ref. no.	Type Ref. no.
Three phase motor, 3~, 400 V, 50/60 Hz, EC motor, protection to IP 54													
GBD EC 710 A	5816	710	15890	775	42	1.50	2.40	976	50	119.0	EUR EC ^{1) 2)} 1347	PU 24 ¹⁾ 1736	PA 24 ¹⁾ 1737
GBD EC 710 B	5819	710	19650	940	48	2.65	4.10	976	50	100.0	EUR EC ^{1) 2)} 1347	PU 24 ¹⁾ 1736	PA 24 ¹⁾ 1737

1) several EC fans can normally be connected 2) alternative electronic differential pressure/temp. controller (EDR/ETR, No. 1437/1438) or three-step speed switch (SU/SA, No. 4266/4267), see accessories

GB

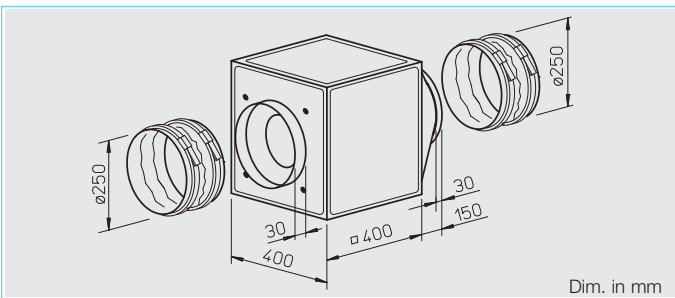
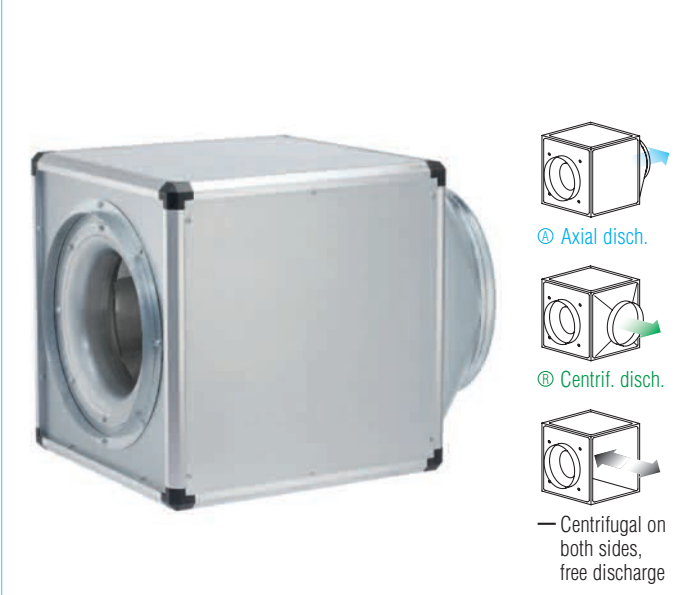

GBW 250/4

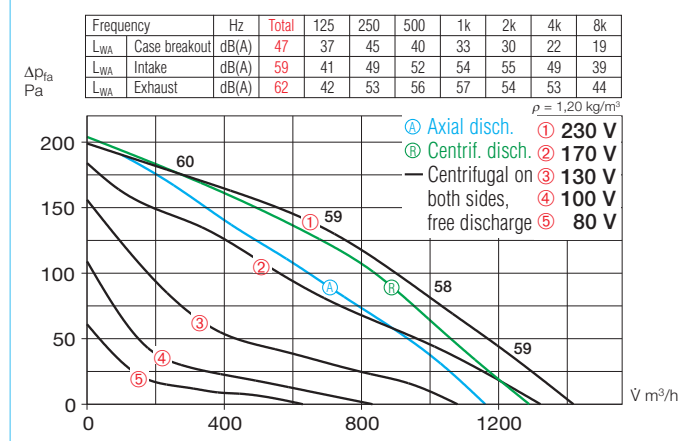

■ Specification

■ Casing

Self-supporting frame construction made from hollow aluminium profiles. Lined with 20 mm thick double-walled side panels made from galvanised sheet steel, sound and thermally insulated with flame-retardant mineral wool. Intake cone for ideal airflow, spigot and flexible connector for duct connection. With discharge adapter (from square to circular) on the pressure side for low-loss discharge and flexible sleeve to reduce vibration transmission. Simple positioning with standard crane hooks.

□ Impeller

Free-running high-performance centrifugal fan made from steel with backward curved blades on a galvanised steel plate, direct driven. Energy efficient with low noise development. Dynamically balanced together with the motor according to DIN ISO 1940 T.1 – grade 6.3.

□ Motor

Through maintenance-free, speed controllable external rotor motor protected to IP 44. Ball bearing mounted, interference-free.

□ Electrical connection

Standard terminal box (IP 54) on motor.

□ Motor protection

Through built-in thermal contacts wired in series with the winding, switches off and on automatically after cooling.

□ Speed control

Through voltage reduction by means of 5-step transformer or electronic speed controller. The performance stages are specified in the performance curve.

□ Installation

Arbitrary installation position and flexible assembly by five possible discharge directions via the discharge adapter. For wall mounting the wall bracket (accessories) has to be used. Outdoor installation is possible using outdoor cover hood and external weather louvres (accessories).

■ Sound levels

Total sound power levels and the spectrum figures in dB(A) are given for:

- Sound level case breakout
 - Sound level intake
 - Sound level exhaust
- In the table below as well as underneath the performance curve you can find additionally the sound pressure levels at 4 m (free field conditions).

■ Accessories

Anti vibration mounts for installation indoors. 1 set = 4 pcs.

SDD-U Ref. no. 5627

Wall bracket for wall mounting.

GB-WK 250 Ref. no. 5625

External weather louvre to cover exhaust opening.

GB-WSG 250 Ref. no. 5637

Outdoor cover hood for protected outdoor installation.

GB-WSD 250 Ref. no. 5746

Condensate collector with condensate spigot (centre) for pipe connection.

GB-KW 250 Ref. no. 5642

Information	Page
Information for planning	10 on General techn. information,
speed control	15 on
Accessory-Details	Page
Speed switch, controller	525 on

Type	Ref. no.	Air flow volume max.	R.P.M.	Sound press. case breakout	Motor power	Current full load	Current controlled	Wiring diagram	max. air flow temperature at full load	Weight net approx.	5-step transformer-speed switch without full motor protection	
		$\text{V m}^3/\text{h}$	min^{-1}	dB(A) in 4 m	kW	A	A	No.	+°C	+°C	kg	Type Ref. no.
Single phase motor, 1~ , 230 V, 50 Hz, capacitor motor, protection to IP 44												
GBW 250/4	5509	1500	1290	27	0.11	0.44	0.48	864	65	65	20.0	TSW 1,5 1495

GB

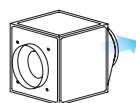

Ⓐ Axial disch.

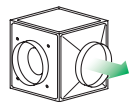

Ⓑ Centrif. disch.

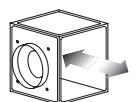

— Centrifugal on both sides, free discharge

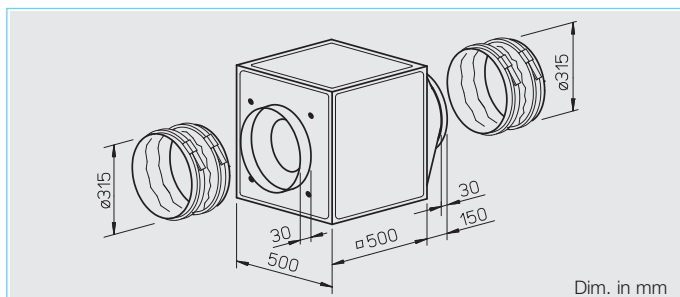

■ Specification

■ Casing

Self-supporting frame construction made from hollow aluminium profiles. Lined with 20 mm thick double-walled side panels made from galvanised sheet steel, sound and thermally insulated with flame-retardant mineral wool. Intake cone for ideal airflow, spigot and flexible connector for duct connection. With discharge adapter (from square to circular) on the pressure side for low-loss discharge and flexible sleeve to reduce vibration transmission. Simple positioning with standard crane hooks.

□ Impeller

Free-running high-performance centrifugal fan made from steel with backward curved blades on a galvanised steel plate, direct driven. Energy efficient with low noise development. Dynamically balanced together with the motor according to DIN ISO 1940 T.1 – grade 6.3.

□ Motor

Through maintenance-free, speed controllable external rotor motor protected to IP 44. Ball bearing mounted, interference-free.

□ Electrical connection

Standard terminal box (IP 54) on motor.

□ Motor protection

Through built-in thermal contacts wired in series with the winding, switches off and on automatically after cooling.

□ Speed control

Through voltage reduction by means of 5-step transformer or electronic speed controller. The performance stages are specified in the performance curve.

GBW 315/4

Frequency	Hz	Total	125	250	500	1k	2k	4k	8k
L _{WA} Case breakout		dB(A) 49	41	45	44	39	34	23	20
L _{WA} Intake		dB(A) 61	49	50	56	56	53	49	36
L _{WA} Exhaust		dB(A) 64	51	55	60	58	55	51	40

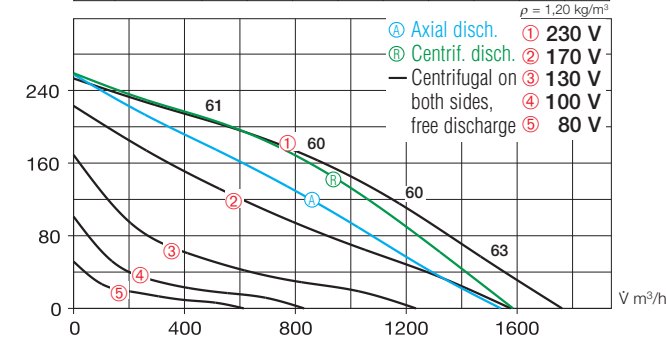

■ Accessories

Anti vibration mounts for installation indoors. 1 set = 4 pcs.

SDD-U Ref. no. 5627

Wall bracket for wall mounting.

GB-WK 315 Ref. no. 5625

External weather louvre to cover exhaust opening.

GB-WSG 315 Ref. no. 5638

Outdoor cover hood for protected outdoor installation.

GB-WSD 315 Ref. no. 5747

Condensate collector with condensate spigot (centre) for pipe connection.

GB-KW 315 Ref. no. 5643

Information	Page
Information for planning	10 on
General techn. information, speed control	15 on
Accessory-Details	Page
Speed switch, controller	525 on

Type	Ref. no.	Air flow volume max.	R.P.M.	Sound press. case breakout	Motor power	Current full load	Current controlled	Wiring diagram	max. air flow temperature at full load	Weight net approx.	5-step transformer-speed switch without full motor protection
		m^3/h	min^{-1}	dB(A) in 4 m	kW	A	A	No.	+°C	+°C	kg
Single phase motor, 1~, 230 V, 50 Hz, capacitor motor, protection to IP 44											
GBW 315/4	5510	1760	1230	29	0,123	0,55	0,55	864	55	55	31,0 TSW 1,5 1495

GB

Arbitrary installation position and flexible assembly by five possible discharge directions.

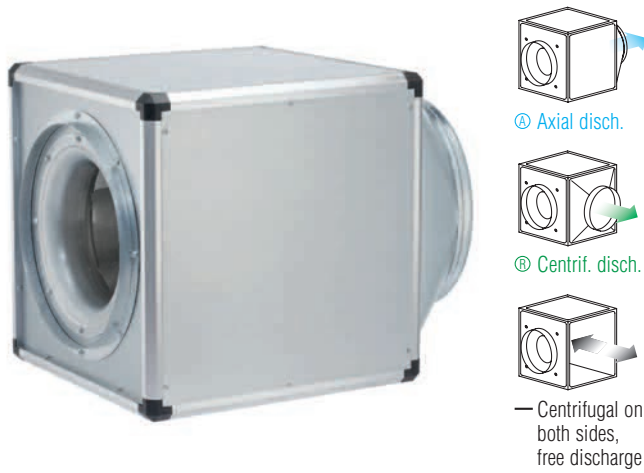

GB T120

Designed for moving dirty, humid and hot air up to max. 120° C. Motor located outside the air flow.

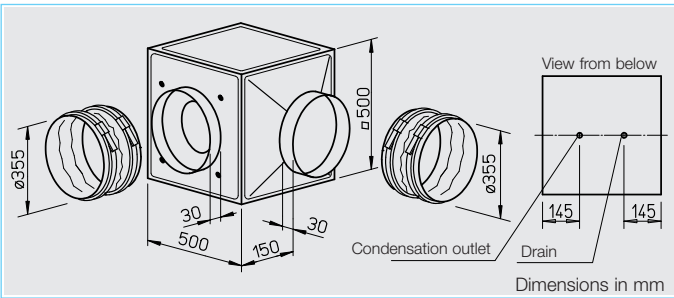
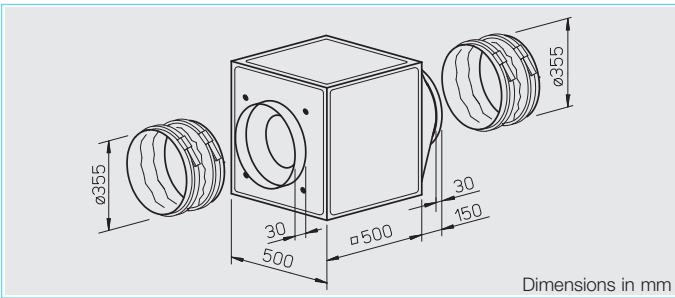
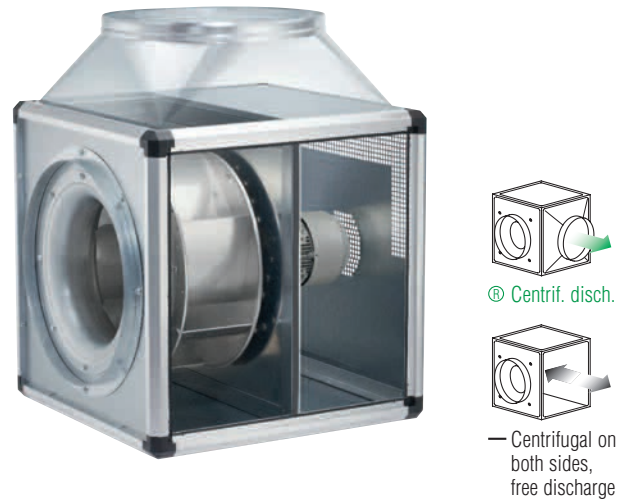

Special features of types GB T120

- Designed for moving dirty, humid and hot air volumes up to max. 120° C.
- Motor located outside of air flow.
- Temperature insulated partition panel between motor and impeller, lined with 20 mm thick, flame-retardant mineral wool.
- Easily accessible motor and impeller unit, removable without disassembling the system components.
- Inspection cover with handle, simply remove for cleaning and maintenance.
- Condensate collector with condensate spigot included in delivery. Drill hole for rain drainage (accessories) for outdoor installation is prepared.

Assembly GB T120

Installation must be carried out with condensation discharge showing downward. Flexible assembly by three possible centrifugal discharge directions via the discharge adapter. Outdoor installation is possible using outdoor cover hood and external weather louvers (accessories).

Feature

Assembly of types GB
Arbitrary installation position and flexible assembly by five possible discharge directions via the discharge adapter. For wall mounting the wall bracket (accessories) have to be used. Outdoor installation is possible using outdoor cover

hood and external weather louvers (accessories).

Specification of both types

Casing
Self-supporting frame construction from aluminium hollow profiles. Double-walled side panels from galvanised sheet steel, lined with 20 mm thick temperature insulating and flame-retardant mineral wool. Intake cone for ideal inflow as well as spigot and flexible sleeve (for the respective max. permissible air flow temperature) for duct connection. With discharge adapter (from square to circular) on the pressure side for low-loss discharge and flexible sleeve to reduce vibration transmission. Simple positioning by standard crane hooks.

Impeller

Smooth running backward curved centrifugal impeller highly efficient with polymer blades on galvanised steel disc (with GB T120 aluminium impeller), direct driven. Energy efficient with a low noise development. Dynamically balanced together with the motor to DIN ISO 1940 Pt.1 – class 6.3.

Motor

Maintenance-free external rotor motor or IEC-standard motor protected to IP 54. With ball bearings and interference-free as standard.

Type	Ref. no.	Air flow volume (FID)	R.P.M.	Sound press. case breakout	Motor power (nominal)	full load	Current speed controlled	Wiring diagram	Maximum air flow temperature Full load	Weight (net) kg	5 step transformer controller with mot. protect. unit	Full motor protection unit using the thermal contacts				
		\dot{V} m ³ /h	min ⁻¹	dB(A) in 4 m	kW	A	A	No.	+°C	+°C	Type	Ref. no.	Type	Ref. no.	Type	Ref. no.
1 Phase motor, 230 V / 1 ph. / 50 Hz, capacitor motor, protection to IP 54																
GBW 355/4	5511	3060	1375	38	0.29	1.47	1.90	864	60	60	MWS 3	1948	TSW 3,0	1496	MW ¹⁾	1579
2 speed motor, 3 Phase motor, 400 V / 3 ph. / 50 Hz, Y/Δ wiring, protection to IP 54																
GBD 355/4/4	5512	2850/3100	1230/1405	34	0.25/0.34	0.41/0.75	0.75	867	55	55	RDS 1	1314	TSD 1,5	1501	MD	5849
1 Phase motor, 230 V / 1 ph. / 50 Hz, capacitor motor, protection to IP 54																
GBW 355/4 T120	5770	3460	1340	36	0.32	1.55	1.75	935	120	120	MWS 3	1948	TSW 3,0	1496	MW ¹⁾	1579
2 speed motor, 3 Phase motor, 400 V / 3 ph. / 50 Hz, Y/Δ wiring, protection to IP 54																
GBD 355/4/4 T120	5771	2990/3470	1100/1360	36	0.22/0.33	0.40/0.75	0.75	947	120	120	RDS 1	1314	TSD 0,8	1500	MD	5849

1) incl. operation switch

GBW 355/4

Frequency	Hz	Total	125	250	500	1k	2k	4k	8k
L _{WA} Case breakout		dB(A) 58	54	54	49	45	42	37	29
L _{WA} Intake		dB(A) 68	55	60	63	62	59	56	53
L _{WA} Exhaust		dB(A) 74	62	65	68	69	67	59	55

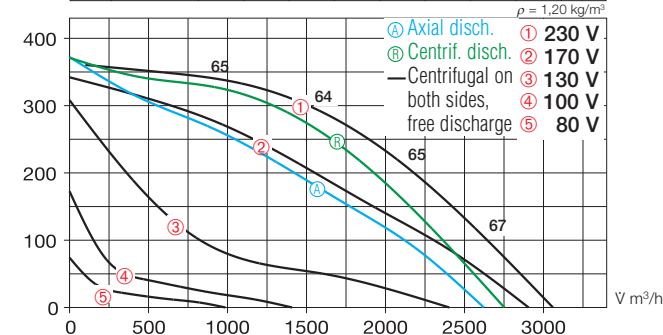

GBD 355/4/4

Frequency	Hz	Total	125	250	500	1k	2k	4k	8k
L _{WA} Case breakout		dB(A) 54	46	50	49	44	39	28	25
L _{WA} Intake		dB(A) 66	54	55	61	61	58	54	41
L _{WA} Exhaust		dB(A) 69	56	60	65	63	60	56	45

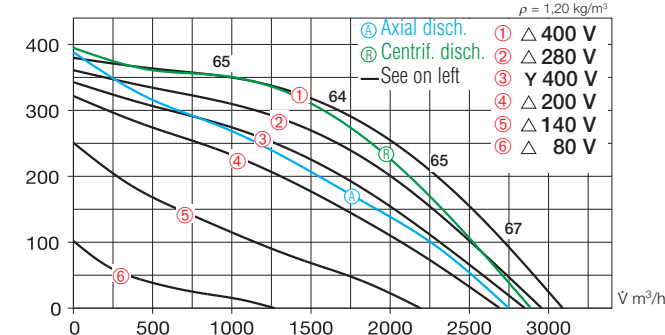

GBW 355/4 T120

Frequency	Hz	Total	125	250	500	1k	2k	4k	8k
L _{WA} Case breakout		dB(A) 56	48	52	49	47	44	41	38
L _{WA} Intake		dB(A) 69	55	61	63	62	63	58	48
L _{WA} Exhaust		dB(A) 71	55	63	64	66	65	57	49

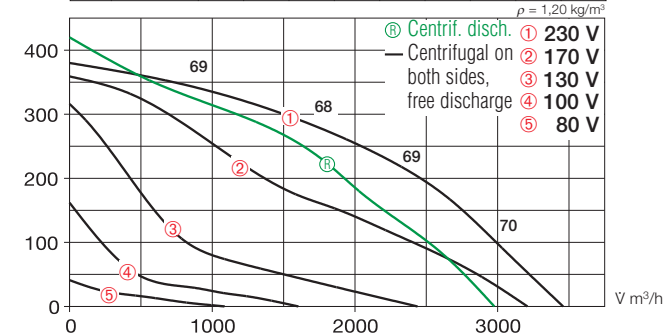

GBD 355/4/4 T120

Frequency	Hz	Total	125	250	500	1k	2k	4k	8k
L _{WA} Case breakout		dB(A) 56	48	52	49	47	44	41	38
L _{WA} Intake		dB(A) 69	55	61	63	62	63	58	48
L _{WA} Exhaust		dB(A) 71	55	63	64	66	65	57	49

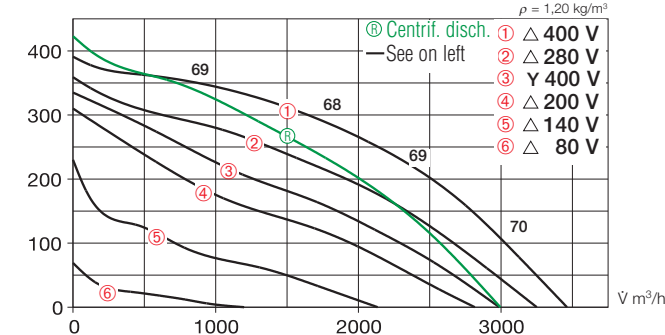

Electrical connection

Standard terminal box (IP 54) fitted on the motor; with GB T120 fitted on the motor support plate.

Motor protection

Motors have thermal contacts wired to the terminal block and must be connected to a motor protection unit.

Speed control

All types are speed controllable by voltage reduction using a transformer controller. The 3-phase models can also be 2 speed controlled by star/delta switch (accessories DS 2 or full motor protection unit M 4). The duties at different speeds are given in the performance curve.

Sound levels

Total sound power levels and the spectrum figures in dB(A) are given for:

- Sound level case breakout
- Sound level intake
- Sound level exhaust

In the table below as well as underneath the performance curve you can find additionally the sound pressure levels at 4 m (free field conditions).

Accessories of both types

Anti vibration mounts for installation indoors. Set of 4.

SDD-U Ref. no. 5627

Wall bracket for wall mounting.

GB-WK 355 Ref. no. 5625

External weather louvers to cover exhaust opening.

GB-WSG 355 Ref. no. 5638

Outdoor cover hood for outdoor installation.

GB-WSD 355 Ref. no. 5747

On/Off and 2-speed switch for 3-phase Y/Δ motors.

Type DS 2²⁾ Ref. no. 1351

²⁾ full motor protection unit recommended: MD Ref. No. 5849

Specific accessories

for types GB

Condensate collector with condensate spigot for pipe connection.

GB-KW 355 Ref. no. 5643

(Condensate collector with condensate spigot included in delivery with GB T120).

for types GB T120

Rain drainage for outdoor installation (drill holes for rain drainage is already prepared).

GB-RA Ref. no. 9418

Information	Page
Information for planning	10 on General techn. information, speed control
Accessory-Details	Page
Speed controller and full motor protection unit	525 on

GB

Arbitrary installation position and flexible assembly by five possible discharge directions.



GB T120

Designed for moving dirty, humid and hot air up to max. 120° C. Motor located outside the air flow.

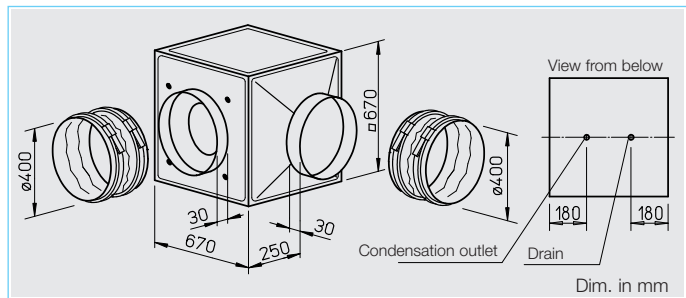
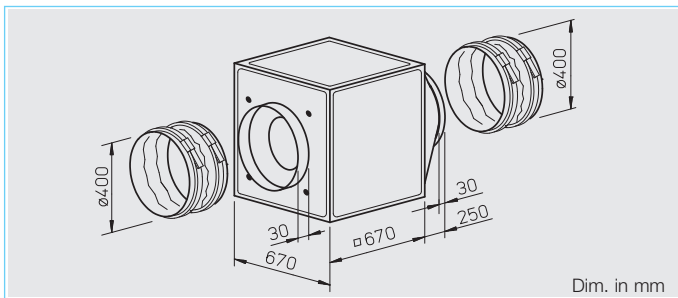

Special features of types GB T120

- Designed for moving dirty, humid and hot air volumes up to max. 120° C.
- Motor located outside of air flow.
- Temperature insulated partition panel between motor and impeller, lined with 20 mm thick, flame-retardant mineral wool.
- Easily accessible motor and impeller unit, removable without disassembling the system components.
- Inspection cover with handle, simply remove for cleaning and maintenance.
- Condensate collector with condensate spigot included in delivery. Drill hole for rain drainage (accessories) for outdoor installation is prepared.

Assembly GB T120

Installation must be carried out with condensation discharge showing downward. Flexible assembly by three possible centrifugal discharge directions via the discharge adapter. Outdoor installation is possible using outdoor cover hood and external weather louvers (accessories).

Feature

Assembly of types GB
 Arbitrary installation position and flexible assembly by five possible discharge directions via the discharge adapter. For wall mounting the wall bracket (accessories) have to be used. Outdoor installation is possible using outdoor cover

hood and external weather louvers (accessories).

Impeller

Smooth running backward curved centrifugal impeller highly efficient with polymer blades on galvanised steel disc (with GB T120 aluminium impeller), direct driven. Energy efficient with a low noise development. Dynamically balanced together with the motor to DIN ISO 1940 Pt.1 – class 6.3.

Motor

Maintenance-free external rotor motor or IEC-standard motor protected to IP 54. With ball bearings and interference-free as standard.

Specification of both types

Casing

Self-supporting frame construction from aluminium hollow profiles. Double-walled side panels from galvanised sheet steel, lined with 20 mm thick temperature insulating and flame-retardant mineral wool. Intake cone for ideal inflow as well as spigot and flexible sleeve (for the respective max. permissible air flow temperature) for duct connection. With discharge adapter (from square to circular) on the pressure side for low-loss discharge and flexible sleeve to reduce vibration transmission. Simple positioning by standard crane hooks.

Type	Ref. no.	Air flow volume (FID)	R.P.M.	Sound press. case breakout	Motor power (nominal)	full load	Current speed controlled	Wiring diagram	Maximum air flow temperature		Weight (net) kg	5 step transformer controller with mot. protect. unit		Full motor protection unit using the thermal contacts		
									Full load	controlled		Type	Ref. no.	Type	Ref. no.	Type
1 Phase motor, 230 V / 1 ph. / 50 Hz, capacitor motor, protection to IP 54																
GBW 400/4	5513	4300	1360	38	0.53	2.40	2.80	864	50	50	52.0	MWS 5	1949	TSW 5,0	1497	MW ¹⁾ 1579
2 speed motor, 3 Phase motor, 400 V / 3 ph. / 50 Hz, Y/Δ wiring, protection to IP 54																
GBD 400/4/4	5514	3700/4100	1193/1390	38	0.38/0.49	0.61/1.05	1.08	867	50	45	52.0	RDS 2	1315	TSD 1,5	1501	MD 5849
1 Phase motor, 230 V / 1 ph. / 50 Hz, capacitor motor, protection to IP 54																
GBW 400/4 T120	5772	4930	1280	40	0.54	2.50	2.50	935	120	100	62.0	MWS 3	1948	TSW 3,0	1496	MW ¹⁾ 1579
2 speed motor, 3 Phase motor, 400 V / 3 ph. / 50 Hz, Y/Δ wiring, protection to IP 54																
GBD 400/4/4 T120	5773	4010/4870	975/1255	40	0.29/0.48	0.50/1.10	1.10	947	120	120	62.0	RDS 1	1314	TSD 1,5	1501	MD 5849

1) incl. operation switch

GBW 400/4

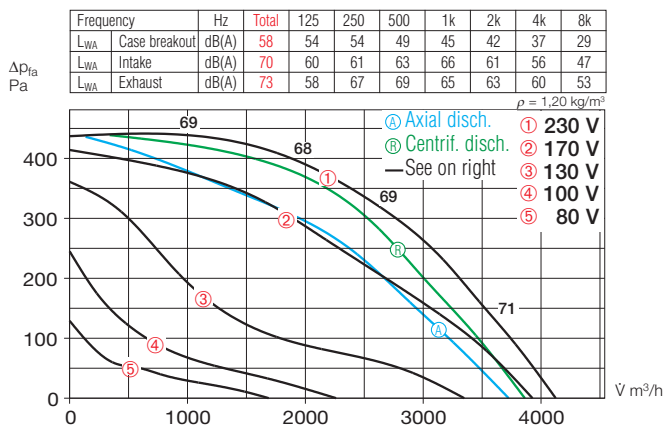

GBW 400/4 T120

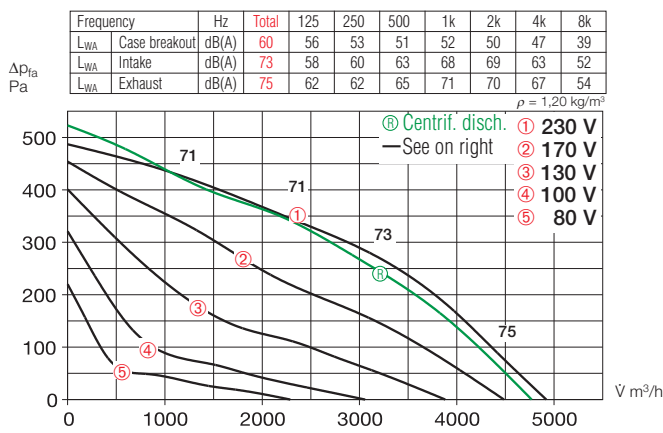

GBD 400/4/4

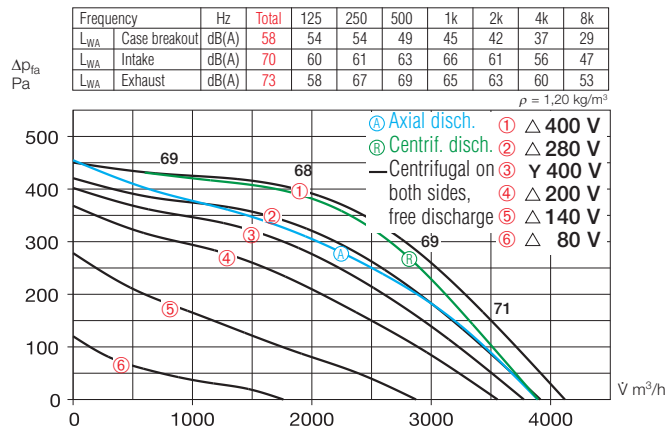

GBD 400/4/4 T120

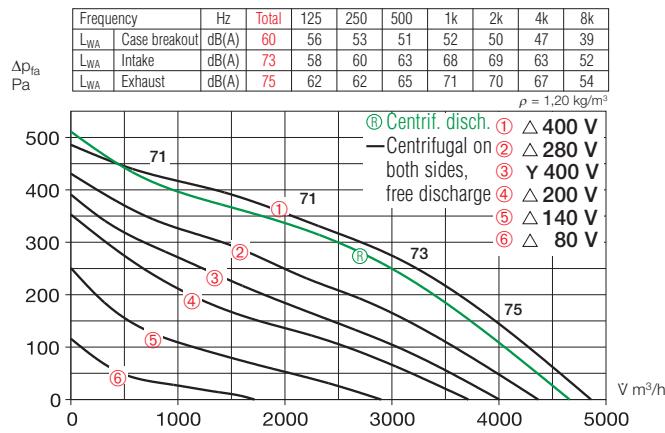

Electrical connection

Standard terminal box (IP 54) fitted on the motor; with GB T120 fitted on the motor support plate.

Motor protection

Motors have thermal contacts wired to the terminal block and must be connected to a motor protection unit.

Speed control

All types are speed controllable by voltage reduction using a transformer controller. The 3-phase models can also be 2 speed controlled by star/delta switch (accessories DS 2 or full motor protection unit M 4). The duties at different speeds are given in the performance curve.

Sound levels

Total sound power levels and the spectrum figures in dB(A) are given for:

- Sound level case breakout
- Sound level intake
- Sound level exhaust

In the table below as well as underneath the performance curve you can find additionally the sound pressure levels at 4 m (free field conditions).

Accessories of both types

Anti vibration mounts for installation indoors. Set of 4.

SDD-U Ref. no. 5627

Wall bracket for wall mounting.

GB-WK 400 Ref. no. 5626

External weather louvers to cover exhaust opening.

GB-WSG 400 Ref. no. 5639

Outdoor cover hood for outdoor installation.

GB-WSD 400 Ref. no. 5748

On/Off and 2-speed switch for 3-phase Y/Δ motors.

Type DS 2²⁾ Ref. no. 1351

²⁾ full motor protection unit recommended: MD Ref. No. 5849

Specific accessories

for types GB

Condensate collector with condensate spigot for pipe connection.

GB-KW 400 Ref. no. 5644

(Condensate collector with condensate spigot included in delivery with GB T120).

for types GB T120

Rain drainage for outdoor installation (drill holes for rain drainage is already prepared).

GB-RA Ref. no. 9418

Information	Page
Information for planning	10 on General techn. information, speed control
Accessory-Details	Page
Speed controller and full motor protection unit	525 on

GB

Arbitrary installation position and flexible assembly by five possible discharge directions.

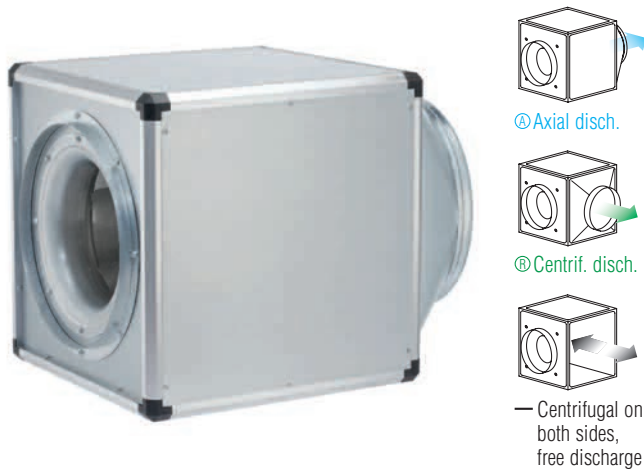

GB T120

Designed for moving dirty, humid and hot air up to max. 120° C. Motor located outside the air flow.

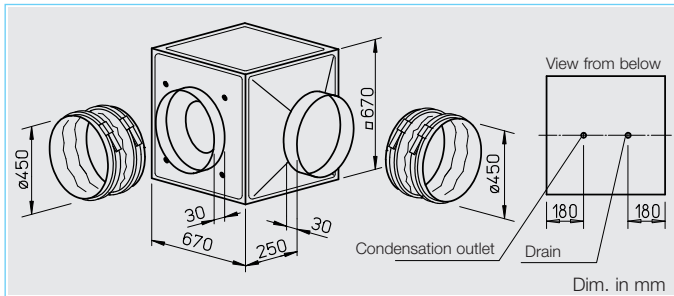
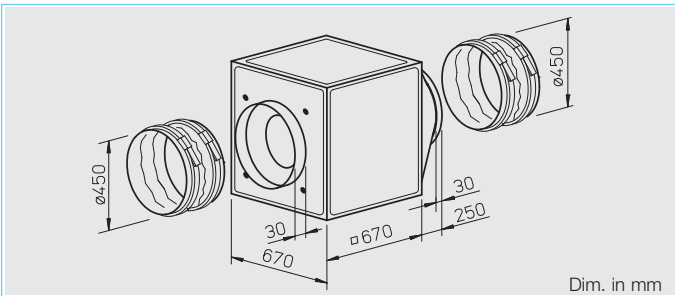
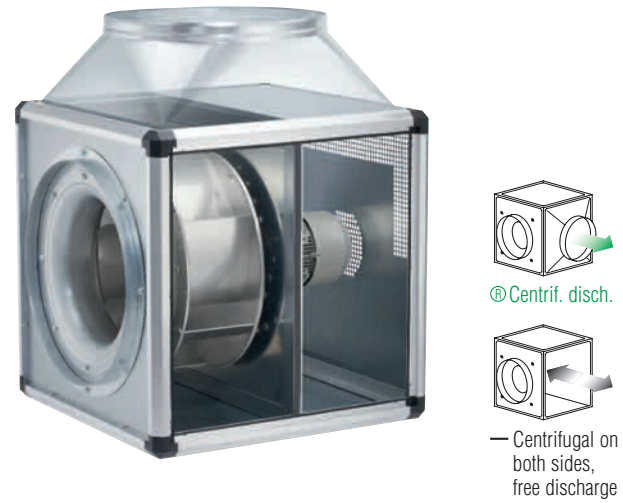

Special features of types GB T120

- Designed for moving dirty, humid and hot air volumes up to max. 120° C.
- Motor located outside of air flow.
- Temperature insulated partition panel between motor and impeller, lined with 20 mm thick, flame-retardant mineral wool.
- Easily accessible motor and impeller unit, removable without disassembling the system components.
- Inspection cover with handle, simply remove for cleaning and maintenance.
- Condensate collector with condensate spigot included in delivery. Drill hole for rain drainage (accessories) for outdoor installation is prepared.

Assembly GB T120

Installation must be carried out with condensation discharge showing downward. Flexible assembly by three possible centrifugal discharge directions via the discharge adapter. Outdoor installation is possible using outdoor cover hood and external weather louvers (accessories).

Feature

Assembly of types GB

Arbitrary installation position and flexible assembly by five possible discharge directions via the discharge adapter. For wall mounting the wall bracket (accessories) have to be used. Outdoor installation is possible using outdoor cover

hood and external weather louvers (accessories).

Impeller

Smooth running backward curved centrifugal impeller highly efficient with polymer blades on galvanised steel disc (with GB T120 aluminium impeller), direct driven. Energy efficient with a low noise development. Dynamically balanced together with the motor to DIN ISO 1940 Pt.1 – class 6.3.

Motor

Maintenance-free external rotor motor or IEC-standard motor protected to IP 54. With ball bearings and interference-free as standard.

Specification of both types

Casing

Self-supporting frame construction from aluminium hollow profiles. Double-walled side panels from galvanised sheet steel, lined with 20 mm thick temperature insulating and flame-retardant mineral wool. Intake cone for ideal inflow as well as spigot and flexible sleeve (for the respective max. permissible air flow temperature) for duct connection. With discharge adapter (from square to circular) on the pressure side for low-loss discharge and flexible sleeve to reduce vibration transmission. Simple positioning by standard crane hooks.

Type	Ref. no.	Air flow volume (FID)	R.P.M.	Sound press. case breakout	Motor power (nominal)	full load	Current speed controlled	Wiring diagram	Maximum air flow temperature		Weight (net) kg	5 step transformer controller with mot. protect. unit		Full motor protection unit using the thermal contacts		
									Full load	controlled		Type	Ref. no.	Type	Ref. no.	Type
1 Phase motor, 230 V / 1 ph. / 50 Hz, capacitor motor, protection to IP 54																
GBW 450/4	5515	4600	1380	40	0.66	2.90	4.0	864	45	45	49.0	MWS 5	1949	TSW 5,0	1497	MW ¹⁾ 1579
2 speed motor, 3 Phase motor, 400 V / 3 ph. / 50 Hz, Y/Δ wiring, protection to IP 54																
GBD 450/4/4	5516	4350/5450	880/1240	40	0.36/0.67	0.67/1.33	1.30	867	55	55	49.0	RDS 2	1315	TSD 1,5	1501	MD 5849
1 Phase motor, 230 V / 1 ph. / 50 Hz, capacitor motor, protection to IP 54																
GBW 450/4 T120	5774	7110	1370	45	1.00	4.60	5.50	935	120	100	74.0	MWS 7,5	1950	TSW 7,5	1596	MW ¹⁾ 1579
2 speed motor, 3 Phase motor, 400 V / 3 ph. / 50 Hz, Y/Δ wiring, protection to IP 54																
GBD 450/4/4 T120	5775	6210/7180	1100/1350	45	0.65/0.90	1.10/1.60	1.80	947	120	110	74.0	RDS 2	1315	TSD 3,0	1502	MD 5849

¹⁾ incl. operation switch

GBW 450/4

Frequency	Hz	Total	125	250	500	1k	2k	4k	8k
L _{WA} Case breakout		dB(A) 60	56	56	51	47	44	39	31
L _{WA} Intake		dB(A) 69	61	63	65	67	65	60	54
L _{WA} Exhaust		dB(A) 75	64	66	68	70	68	63	57

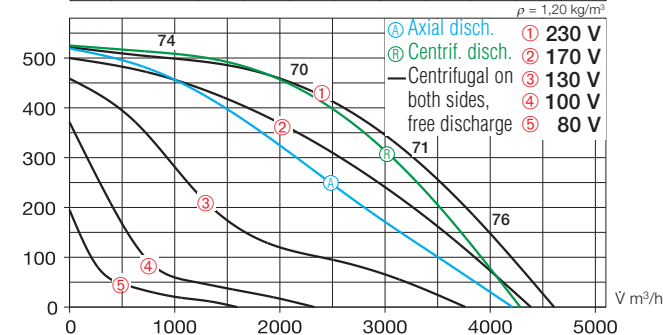

GBW 450/4 T120

Frequency	Hz	Total	125	250	500	1k	2k	4k	8k
L _{WA} Case breakout		dB(A) 65	61	58	56	57	55	52	44
L _{WA} Intake		dB(A) 77	62	64	67	72	73	67	56
L _{WA} Exhaust		dB(A) 80	67	68	70	76	75	72	59

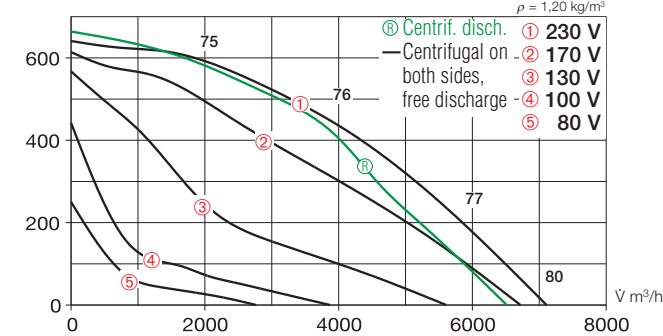

GBD 450/4/4

Frequency	Hz	Total	125	250	500	1k	2k	4k	8k
L _{WA} Case breakout		dB(A) 60	56	56	51	47	44	39	31
L _{WA} Intake		dB(A) 72	62	63	65	68	63	58	49
L _{WA} Exhaust		dB(A) 75	60	69	71	67	65	62	55

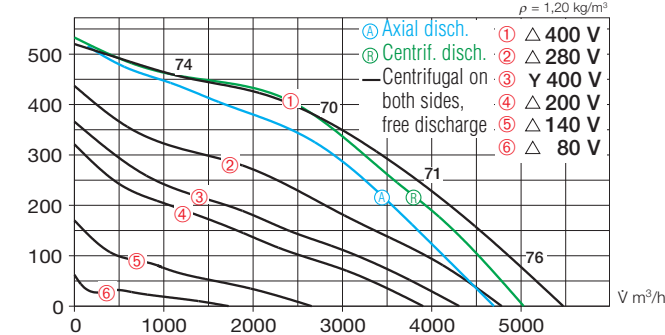

GBD 450/4/4 T120

Frequency	Hz	Total	125	250	500	1k	2k	4k	8k
L _{WA} Case breakout		dB(A) 65	61	58	56	57	55	52	44
L _{WA} Intake		dB(A) 77	62	64	67	72	73	67	56
L _{WA} Exhaust		dB(A) 80	67	68	70	76	75	72	59

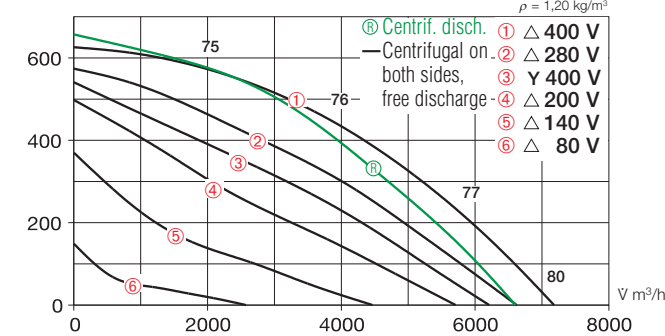

Electrical connection

Standard terminal box (IP 54) fitted on the motor; with GB T120 fitted on the motor support plate.

Motor protection

Motors have thermal contacts wired to the terminal block and must be connected to a motor protection unit.

Speed control

All types are speed controllable by voltage reduction using a transformer controller. The 3-phase models can also be 2 speed controlled by star/delta switch (accessories DS 2 or full motor protection unit M 4). The duties at different speeds are given in the performance curve.

Sound levels

Total sound power levels and the spectrum figures in dB(A) are given for:

- Sound level case breakout
- Sound level intake
- Sound level exhaust

In the table below as well as underneath the performance curve you can find additionally the sound pressure levels at 4 m (free field conditions).

Accessories of both types

Anti vibration mounts for installation indoors. Set of 4.

SDD-U Ref. no. 5627

Wall bracket for wall mounting.

GB-WK 450 Ref. no. 5626

External weather louvers to cover exhaust opening.

GB-WSG 450 Ref. no. 5639

Outdoor cover hood for outdoor installation.

GB-WSD 450 Ref. no. 5748

On/Off and 2-speed switch for 3-phase Y/Δ motors.

Type DS 2²⁾ Ref. no. 1351

²⁾ full motor protection unit recommended: MD Ref. No. 5849

Specific accessories

for types GB

Condensate collector with condensate spigot for pipe connection.

GB-KW 450 Ref. no. 5644

(Condensate collector with condensate spigot included in delivery with GB T120).

for types GB T120

Rain drainage for outdoor installation (drill holes for rain drainage is already prepared).

GB-RA Ref. no. 9418

Information	Page
Information for planning	10 on
General techn. information, speed control	15 on
Accessory-Details	Page
Speed controller and full motor protection unit	525 on

GB

Arbitrary installation position and flexible assembly by five possible discharge directions.

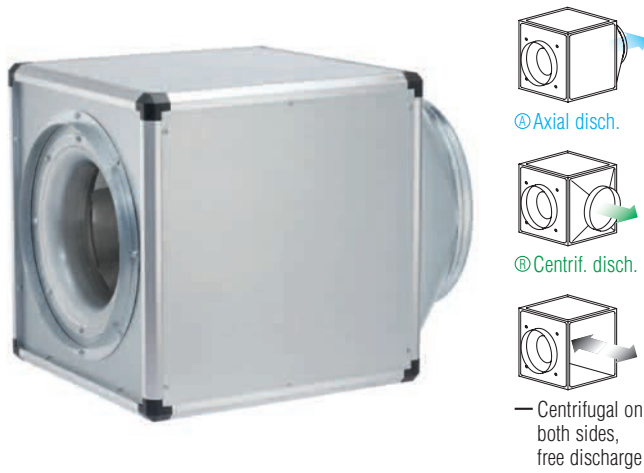

GB T120

Designed for moving dirty, humid and hot air up to max. 120° C. Motor located outside the air flow.

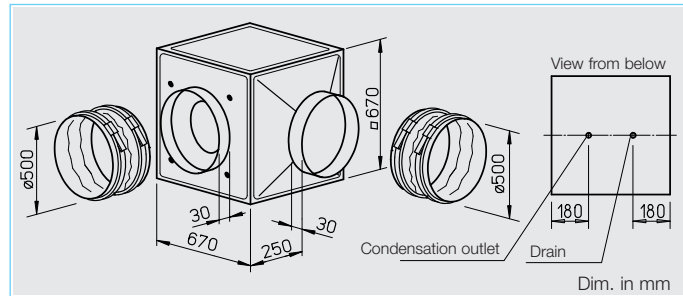
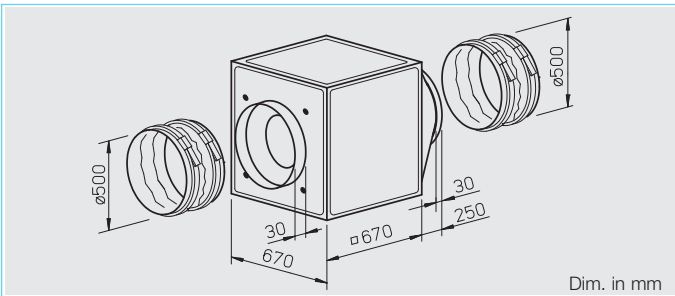
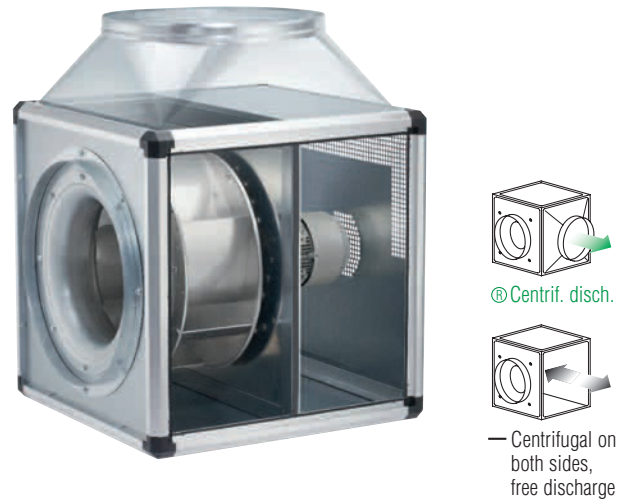

Special features of types GB T120

- Designed for moving dirty, humid and hot air volumes up to max. 120° C.
- Motor located outside of air flow.
- Temperature insulated partition panel between motor and impeller, lined with 20 mm thick, flame-retardant mineral wool.
- Easily accessible motor and impeller unit, removable without disassembling the system components.
- Inspection cover with handle, simply remove for cleaning and maintenance.
- Condensate collector with condensate spigot included in delivery. Drill hole for rain drainage (accessories) for outdoor installation is prepared.

Assembly GB T120

Installation must be carried out with condensation discharge showing downward. Flexible assembly by three possible centrifugal discharge directions via the discharge adapter. Outdoor installation is possible using outdoor cover hood and external weather louvers (accessories).

Feature

Assembly of types GB

Arbitrary installation position and flexible assembly by five possible discharge directions via the discharge adapter. For wall mounting the wall bracket (accessories) have to be used. Outdoor installation is possible using outdoor cover

hood and external weather louvers (accessories).

Impeller

Smooth running backward curved aluminium centrifugal impeller highly efficient and direct driven. Energy efficient with a low noise development. Dynamically balanced together with the motor to DIN ISO 1940 Pt.1 – class 6.3.

Motor

Maintenance-free external rotor motor or IEC-standard motor protected to IP 54. With ball bearings and interference-free as standard.

Electrical connection

Standard terminal box (IP 54) fitted on the motor; with GB T120 fitted on the motor support plate.

Specification of both types

Casing

Self-supporting frame construction from aluminium hollow profiles. Double-walled side panels from galvanised sheet steel, lined with 20 mm thick temperature insulating and flame-retardant mineral wool. Intake cone for ideal inflow as well as spigot and flexible sleeve (for the respective max. permissible air flow temperature) for duct connection. With discharge adapter (from square to circular) on the pressure side for low-loss discharge and flexible sleeve to reduce vibration transmission. Simple positioning by standard crane hooks.

Type	Ref. no.	Air flow volume (FID)	R.P.M.	Sound press. case breakout	Motor power (nominal)	full load	Current speed controlled	Wiring diagram	Maximum air flow temperature		Weight (net) kg	5 step transformer controller with mot. protect. unit		Full motor protection unit using the thermal contacts			
									Full load	controlled		Type	Ref. no.	Type	Ref. no.	Type	Ref. no.
1 Phase motor, 230 V / 1 ph. / 50 Hz, capacitor motor, protection to IP 54																	
GBW 500/4	5517	8321	1401	47	1.50	6.70	9.60	865	65	55	61	MWS 10	1946	TSW 10	1498	MW ¹⁾	1579
2 speed motor, 3 Phase motor, 400 V / 3 ph. / 50 Hz, Y/Δ wiring, protection to IP 54																	
GBD 500/4/4	5518	8000/9200	1075/1340	45	0.97/1.45	1.60/2.80	2.90	867	50	50	57	RDS 7	1578	TSD 5,5	1503	MD	5849
1 Phase motor, 230 V / 1 ph. / 50 Hz, capacitor motor, protection to IP 54																	
GBW 500/4 T120	5776	8345	1340	45	1.40	6.1	7.0	301	120	100	75	MWS 10	1946	—	—	—	—
2 speed motor, 3 Phase motor, 400 V / 3 ph. / 50 Hz, Y/Δ wiring, protection to IP 54																	
GBD 500/4/4 T120	5777	7320/8350	1120/1370	45	0.95/1.30	1.60/2.50	2.5	947	120	110	75	RDS 4	1316	TSD 3,0	1502	MD	5849

1) incl. operation switch

GBW 500/4

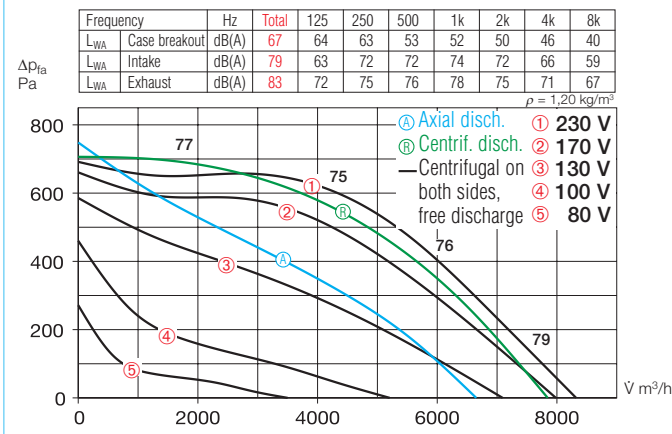

GBW 500/4 T120

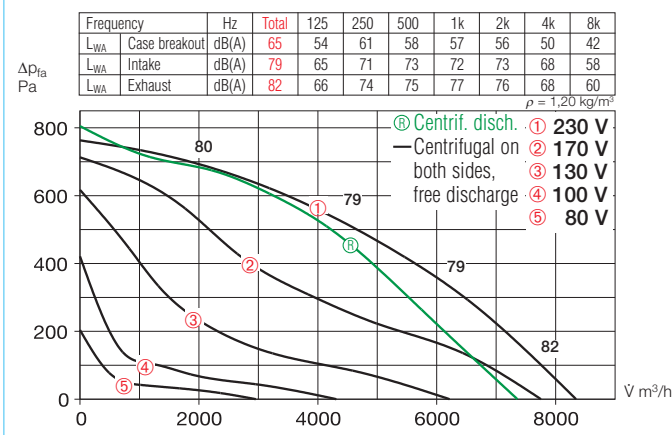

GBD 500/4/4

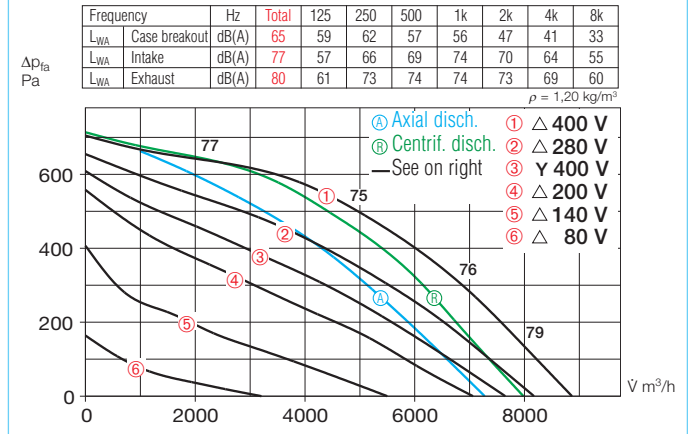

GBD 500/4/4 T120

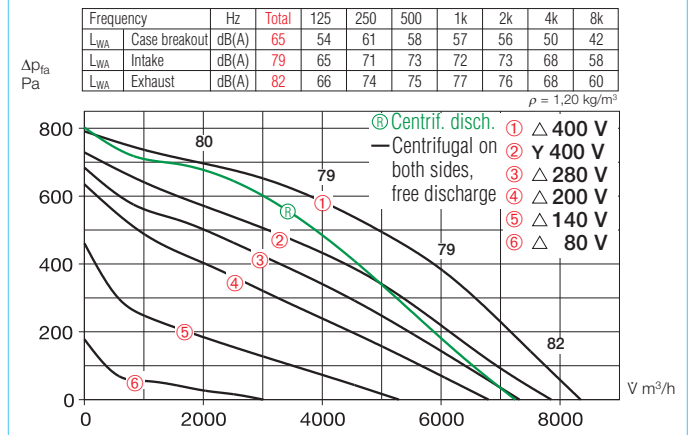

Motor protection

Motors have thermal contacts wired to the terminal block and must be connected to a motor protection unit.

Speed control

All types are speed controllable by voltage reduction using a transformer controller. The 3-phase models can also be 2 speed controlled by star/delta switch (accessories DS 2 or full motor protection unit M 4). The duties at different speeds are given in the performance curve.

Sound levels

Total sound power levels and the spectrum figures in dB(A) are given for:

- Sound level case breakout
- Sound level intake
- Sound level exhaust

In the table below as well as underneath the performance curve you can find additionally the sound pressure levels at 4 m (free field conditions).

Accessories of both types

Anti vibration mounts for installation indoors. Set of 4.

SDD-U Ref. no. 5627

Wall bracket for wall mounting.

GB-WK 500 Ref. no. 5626

External weather louvers to cover exhaust opening.

GB-WSG 500 Ref. no. 5639

Outdoor cover hood for outdoor installation.

GB-WSD 500 Ref. no. 5748

On/Off and 2-speed switch for 3-phase Y/Δ motors.

Type DS 2²⁾ Ref. no. 1351

²⁾ full motor protection unit recommended:
MD Ref. No. 5849

Specific accessories

for types GB

Condensate collector with condensate spigot for pipe connection.

GB-KW 500 Ref. no. 5644

(Condensate collector with condensate spigot included in delivery with GB T120).

for types GB T120

Rain drainage for outdoor installation (drill holes for rain drainage is already prepared).

GB-RA Ref. no. 9418

Information	Page
Information for planning	10 on General techn. information, speed control
Accessory-Details	Page
Speed controller and full motor protection unit	525 on

GB

Arbitrary installation position and flexible assembly by five possible discharge directions.

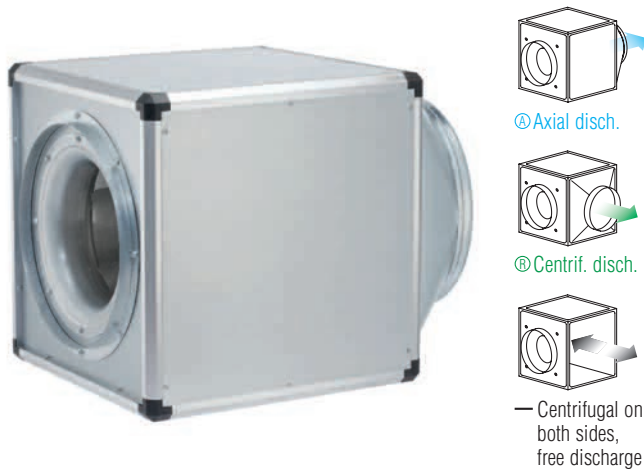

GB T120

Designed for moving dirty, humid and hot air up to max. 120° C. Motor located outside the air flow.

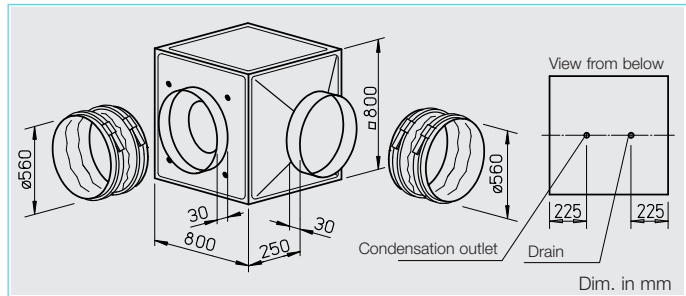
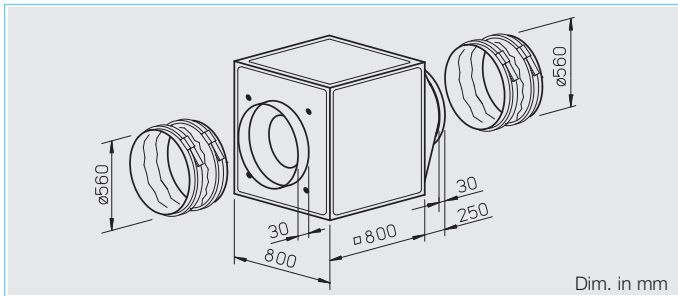
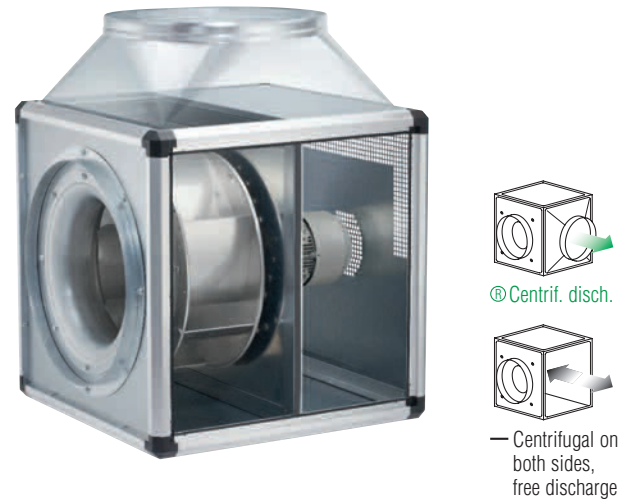

Special features of types GB T120

- Designed for moving dirty, humid and hot air volumes up to max. 120° C.
- Motor located outside of air flow.
- Temperature insulated partition panel between motor and impeller, lined with 20 mm thick, flame-retardant mineral wool.
- Easily accessible motor and impeller unit, removable without disassembling the system components.
- Inspection cover with handle, simply remove for cleaning and maintenance.
- Condensate collector with condensate spigot included in delivery. Drill hole for rain drainage (accessories) for outdoor installation is prepared.

Assembly GB T120

Installation must be carried out with condensation discharge showing downward. Flexible assembly by three possible centrifugal discharge directions via the discharge adapter. Outdoor installation is possible using outdoor cover hood and external weather louvers (accessories).

Feature

Assembly of types GB
Arbitrary installation position and flexible assembly by five possible discharge directions via the discharge adapter. For wall mounting the wall bracket (accessories) have to be used. Outdoor installation is possible using outdoor cover

hood and external weather louvers (accessories).

Specification of both types

Casing

Self-supporting frame construction from aluminium hollow profiles. Double-walled side panels from galvanised sheet steel, lined with 20 mm thick temperature insulating and flame-retardant mineral wool. Intake cone for ideal inflow as well as spigot and flexible sleeve (for the respective max. permissible air flow temperature) for duct connection. With discharge adapter (from square to circular) on the pressure side for low-loss discharge and flexible sleeve to reduce vibration transmission. Simple positioning by standard crane hooks.

Impeller

Smooth running backward curved aluminium centrifugal impeller highly efficient and direct driven. Energy efficient with a low noise development. Dynamically balanced together with the motor to DIN ISO 1940 Pt.1 – class 6.3.

Motor

Maintenance-free external rotor motor or IEC-standard motor protected to IP 54. With ball bearings and interference-free as standard.

Electrical connection

Standard terminal box (IP 54) fitted on the motor; with GB T120 fitted on the motor support plate.

Type	Ref. no.	Air flow volume (FID)	R.P.M.	Sound press. case breakout	Motor power (nominal)	Full load	Current speed controlled	Wiring diagram	Maximum air flow temperature Full load	Weight (net) kg	5 step transformer controller with mot. protect. unit	Standard motor protection unit using the thermal contacts				
		m^3/h	min^{-1}	dB(A) in 4 m	kW	A	A	No.	+°C	+°C	Type	Ref. no.	Type	Ref. no.	Type	Ref. no.
1 Phase motor, 230 V / 1 ph. / 50 Hz, capacitor motor, protection to IP 54																
GBW 560/4	5508	9123	1409	45	1.83	7.93	10.4	867	45	45	MWS 10	1946	TSW 10	1498	MW ¹⁾	1579
2 speed motor, 3 Phase motor, 400 V / 3 ph. / 50 Hz, Y/Δ wiring, protection to IP 54																
GBD 560/6/6	5522	7800/9000	705/885	35	0.51/0.80	0.90/1.85	1.90	867	60	60	RDS 4	1316	TSD 3,0	1502	MD	5849
GBD 560/4/4	5521	11500/13000	1110/1350	44	1.70/2.60	2.80/4.80	4.90	867	55	45	RDS 7	1578	TSD 7,0	1504	MD	5849
2 speed motor, 3 Phase motor, 400 V / 3 ph. / 50 Hz, Y/Δ wiring, protection to IP 54																
GBD 560/4/4 T120	5778	11520/12300	1250/1400	48	1.85/2.50	3.20/6.80	6.80	520	120	120	RDS 7	1578	TSD 7,0	1504	MD	5849

¹⁾ incl. operation switch

GBD 560/6/6

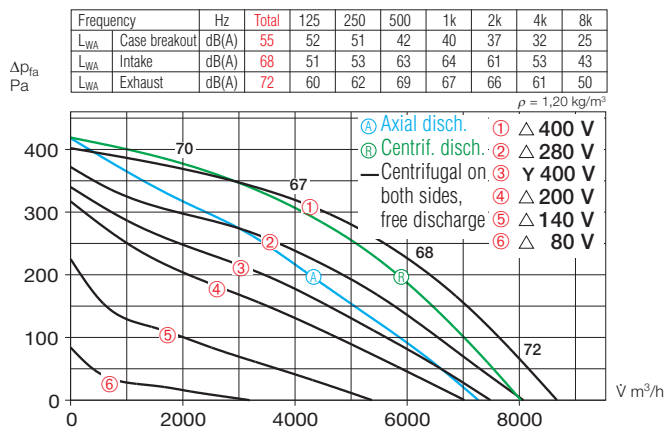

GBD 560/4/4

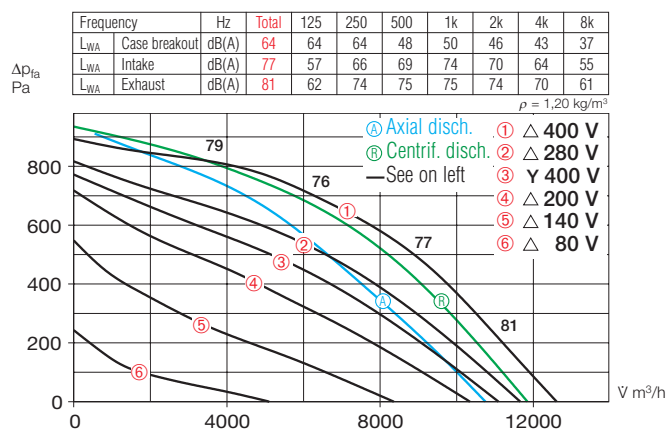

GBD 560/4/4 T120

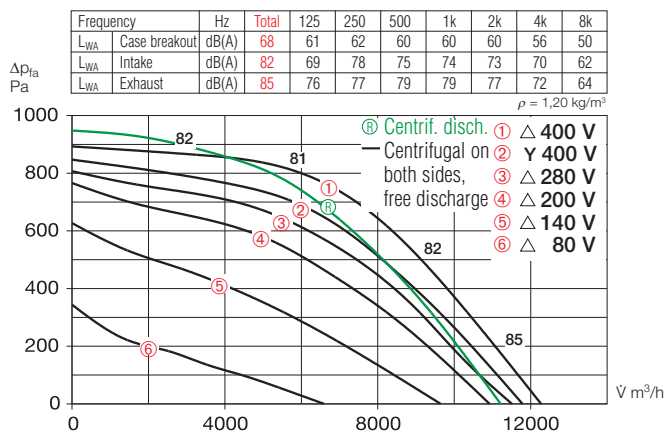

GBW 560/4

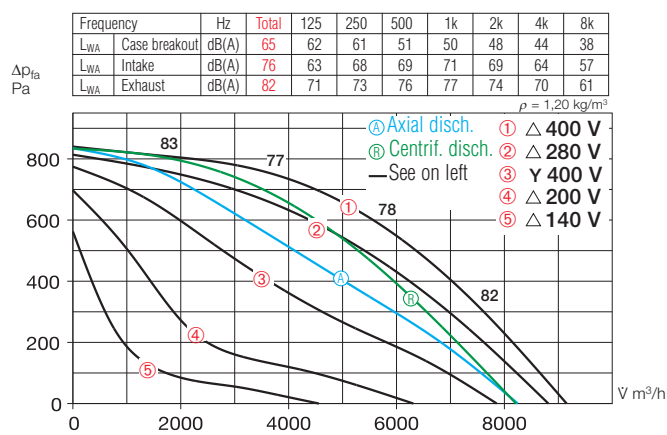

Motor protection

Motors have thermal contacts wired to the terminal block and must be connected to a motor protection unit.

Speed control

All types are speed controllable by voltage reduction using a transformer controller. The 3-phase models can also be 2 speed controlled by star/delta switch (accessories DS 2 or full motor protection unit M 4). The duties at different speeds are given in the performance curve.

Sound levels

Total sound power levels and the spectrum figures in dB(A) are given for:

- Sound level case breakout
- Sound level intake
- Sound level exhaust

In the table below as well as underneath the performance curve you can find additionally the sound pressure levels at 4 m (free field conditions).

Accessories of both types

Anti vibration mounts for installation indoors. Set of 4.

SDD-U Ref. no. 5627

Wall bracket for wall mounting.

GB-WK 560 Ref. no. 5626

External weather louvers to cover exhaust opening.

GB-WSG 560 Ref. no. 5640

Outdoor cover hood for outdoor installation.

GB-WSD 560 Ref. no. 5749

On/Off and 2-speed switch for 3-phase Y/ Δ motors.

Type DS 2²⁾ Ref. no. 1351

²⁾ full motor protection unit recommended:
MD Ref. No. 5849

Specific accessories

for types GB

Condensate collector with condensate spigot for pipe connection.

GB-KW 560 Ref. no. 5645

(Condensate collector with condensate spigot included in delivery with GB T120).

for types GB T120

Rain drainage for outdoor installation (drill holes for rain drainage is already prepared).

GB-RA Ref. no. 9418

Information	Page
Information for planning	10 on General techn. information, speed control
Accessory-Details	Page
Speed controller and full motor protection unit	525 on

GB

Arbitrary installation position and flexible assembly by five possible discharge directions.

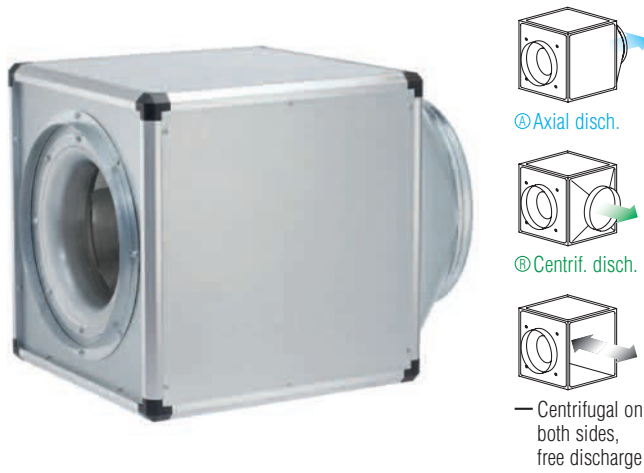

GB T120

Designed for moving dirty, humid and hot air up to max. 120° C. Motor located outside the air flow.

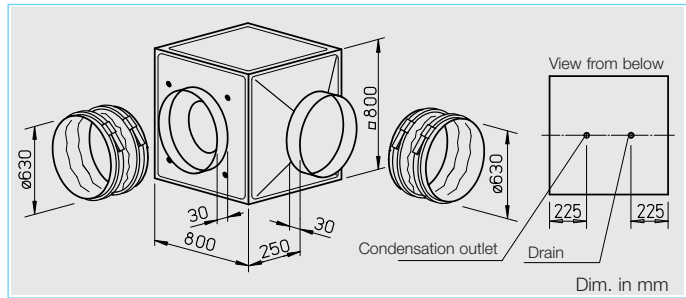
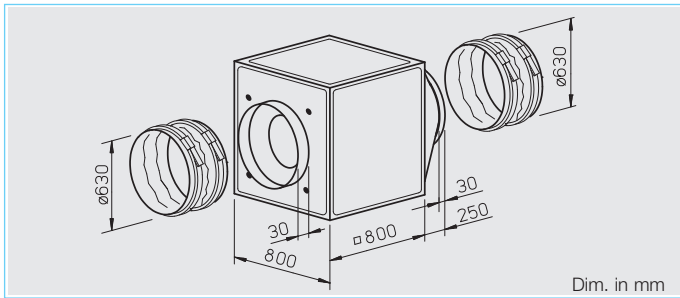
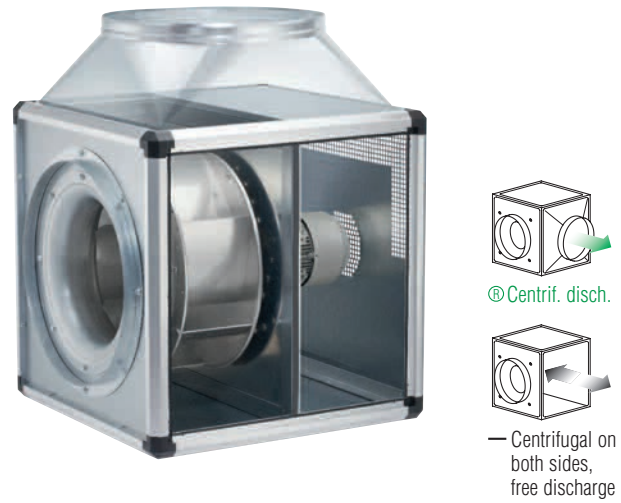

Special features of types GB T120

- Designed for moving dirty, humid and hot air volumes up to max. 120° C.
- Motor located outside of air flow.
- Temperature insulated partition panel between motor and impeller, lined with 20 mm thick, flame-retardant mineral wool.
- Easily accessible motor and impeller unit, removable without disassembling the system components.
- Inspection cover with handle, simply remove for cleaning and maintenance.
- Condensate collector with condensate spigot included in delivery. Drill hole for rain drainage (accessories) for outdoor installation is prepared.

Assembly GB T120

Installation must be carried out with condensation discharge showing downward. Flexible assembly by three possible centrifugal discharge directions via the discharge adapter. Outdoor installation is possible using outdoor cover hood and external weather louvers (accessories).

Feature

Assembly of types GB
Arbitrary installation position and flexible assembly by five possible discharge directions via the discharge adapter. For wall mounting the wall bracket (accessories) have to be used. Outdoor installation is possible using outdoor cover

hood and external weather louvers (accessories).

Specification of both types

Casing
Self-supporting frame construction from aluminium hollow profiles. Double-walled side panels from galvanised sheet steel, lined with 20 mm thick temperature insulating and flame-retardant mineral wool. Intake cone for ideal inflow as well as spigot and flexible sleeve (for the respective max. permissible air flow temperature) for duct connection. With discharge adapter (from square to circular) on the pressure side for low-loss discharge and flexible sleeve to reduce vibration transmission. Simple positioning by standard crane hooks.

Impeller

Smooth running backward curved aluminium centrifugal impeller highly efficient and direct driven. Energy efficient with a low noise development. Dynamically balanced together with the motor to DIN ISO 1940 Pt.1 – class 6.3.

Motor

Maintenance-free external rotor motor or IEC-standard motor protected to IP 54. With ball bearings and interference-free as standard.

Electrical connection

Standard terminal box (IP 54) fitted on the motor; with GB T120 fitted on the motor support plate.

Type	Ref. no.	Air flow volume (FID) V m³/h	R.P.M. min⁻¹	Sound press. case breakout dB(A) in 4 m	Motor power (nominal) kW	Current full load A	Current speed controlled A	Wiring diagram No.	Maximum air flow temperature		Weight (net) kg	5 step transformer controller with mot. protect. unit		Full motor protection unit using the thermal contacts			
									Full load	controlled		Type	Ref. no.	Type	Ref. no.	Type	Ref. no.
2 speed motor, 3 Phase motor, 400 V / 3 ph. / 50 Hz, Y/Δ wiring, protection to IP 54																	
GBD 630/6/6	5524	8600/9990	723/893	42	0.64/0.93	1.08/1.88	2.03	867	60	60	86	RDS 4	1316	TSD 5,5	1503	MD	5849
GBD 630/4/4	5523	12954/14430	1128/1383	51	2.40/3.45	4.10/6.20	7.20	867	75	50	105	RDS 11	1332	TSD 11,0	1513	MD	5849
3 Phase motor, 3~, 400 V, 50 Hz, protection to IP 54																	
GBD 630/4 T120	5779	14200	1445	53	4.40	8.0	—	499	120	—	105	—	—	—	—	MD	5849

GBD 630/6/6

Frequency	Hz	Total	125	250	500	1k	2k	4k	8k
L _{WA} Case breakout		dB(A)	62	59	58	47	45	41	35
L _{WA} Intake		dB(A)	73	63	64	67	66	63	57
L _{WA} Exhaust		dB(A)	79	68	72	73	73	66	59

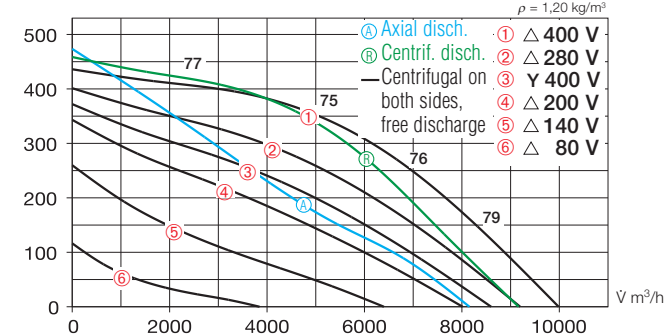

GBD 630/4 T120

Frequency	Hz	Total	125	250	500	1k	2k	4k	8k
L _{WA} Case breakout		dB(A)	73	66	67	65	65	61	55
L _{WA} Intake		dB(A)	87	74	83	80	79	75	67
L _{WA} Exhaust		dB(A)	90	81	82	84	84	77	69

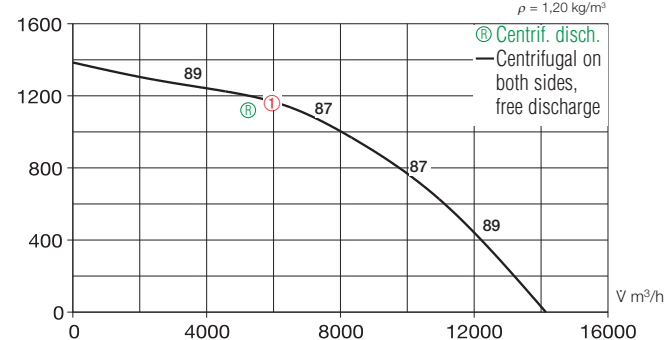

GBD 630/4/4

Frequency	Hz	Total	125	250	500	1k	2k	4k	8k
L _{WA} Case breakout		dB(A)	71	68	57	57	56	54	44
L _{WA} Intake		dB(A)	82	72	73	76	75	72	66
L _{WA} Exhaust		dB(A)	88	77	81	82	80	75	68

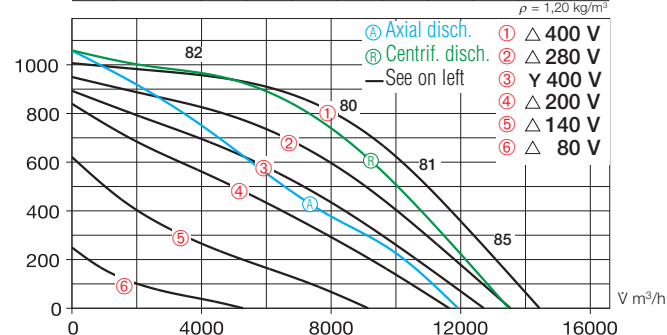

Motor protection

Types GBD with thermal contacts embedded on the terminal strip, which must be wired with the full motor protection device. Type GBD T120 with PTC thermistor for direct wiring with the full motor protection device or frequency inverter FU-BS (see table below, accessories).

Speed control

All types (except GB T120) are speed controllable by voltage reduction using a transformer controller. The 3-phase models can also be 2 speed controlled by Y/ Δ switch or full motor protection unit M4; Type GBD T120 is exclusively controllable via frequency inverter with Sine filter. The duties at different speeds are given in the performance curve.

Sound levels

Total sound power levels and the spectrum figures in dB(A) are given for:

- Sound level case breakout
- Sound level intake
- Sound level exhaust

In the table below as well as underneath the performance curve you can find additionally the sound pressure levels at 4 m (free field conditions).

Accessories of both types

Anti vibration mounts for installation indoors. Set of 4.

SDD-U Ref. no. 5627

Wall bracket for wall mounting.

GB-WK 630 Ref. no. 5626

External weather louvers to cover exhaust opening.

GB-WSG 630 Ref. no. 5640

Outdoor cover hood for outdoor installation.

GB-WSD 630 Ref. no. 5749

Specific accessories

for types GB

Condensate collector with condensate spigot for pipe connection.

GB-KW 630 Ref. no. 5645

(Condensate collector with condensate spigot included in delivery with GB T120).

On/Off and 2-speed switch for 3-phase Y/ Δ motors.

Type DS 2¹⁾ Ref. no. 1351

¹⁾ full motor protection unit recommended: MD Ref. No. 5849

for types GB T120

Rain drainage for outdoor installation (drill holes for rain drainage is already prepared).

GB-RA Ref. no. 9418

Information	Page
Information for planning	10 on
General techn. information, speed control	15 on
Accessory-Details	Page
Speed controller and full motor protection unit	525 on

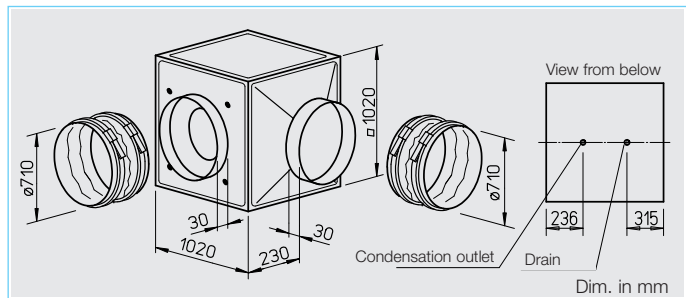
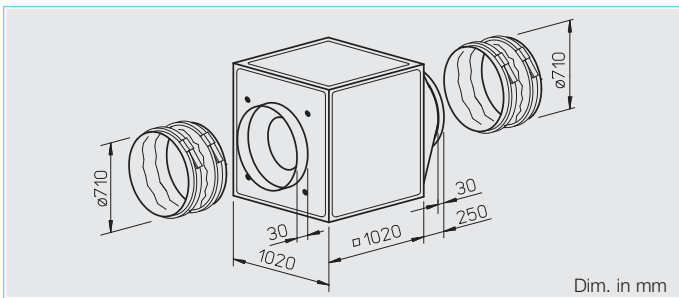

Special features of types GB T120

- Designed for moving dirty, humid and hot air volumes up to max. 120° C.
- Motor located outside of air flow.
- Temperature insulated partition panel between motor and impeller, lined with 20 mm thick, flame-retardant mineral wool.
- Easily accessible motor and impeller unit, removable without disassembling the system components.
- Inspection cover with handle, simply remove for cleaning and maintenance.
- Condensate collector with condensate spigot included in delivery. Drill hole for rain drainage (accessories) for outdoor installation is prepared.

Assembly GB T120

Installation must be carried out with condensation discharge showing downward. Flexible assembly by three possible centrifugal discharge directions via the discharge adapter. Outdoor installation is possible using outdoor cover hood and external weather louvers (accessories).

Feature

Assembly of types GB
 Arbitrary installation position and flexible assembly by five possible discharge directions via the discharge adapter. For wall mounting the wall bracket (accessories) have to be used. Outdoor installation is possible using outdoor cover

hood and external weather louvers (accessories).

Specification of both types

Casing
 Self-supporting frame construction from aluminium hollow profiles. Double-walled side panels from galvanised sheet steel, lined with 20 mm thick temperature insulating and flame-retardant mineral wool. Intake cone for ideal inflow as well as spigot and flexible sleeve (for the respective max. permissible air flow temperature) for duct connection. With discharge adapter (from square to circular) on the pressure side for low-loss discharge and flexible sleeve to reduce vibration transmission. Simple positioning by standard crane hooks.

Impeller

Smooth running backward curved aluminium centrifugal impeller highly efficient and direct driven. Energy efficient with a low noise development. Dynamically balanced together with the motor to DIN ISO 1940 Pt.1 – class 6.3.

Motor

Maintenance-free external rotor motor or IEC-standard motor protected to IP 54/55. With ball bearings and interference-free as standard.

Electrical connection

Standard terminal box (IP 54/55) fitted on the motor; with GB T120 fitted on the motor support plate.

Type	Ref. no.	Air flow volume (FID)	R.P.M.	Sound press. case breakout	Motor power (nominal)	Current		Wiring diagram	Maximum air flow temperature		Weight (net) kg	5 step transformer controller		Full motor protection unit using the thermal contacts			
						full load	speed controlled		Full load	controlled		mot. protect. unit	without mot. protect. unit	Type	Ref. no.	Type	Ref. no.
		V m³/h	min⁻¹	dB(A) in 4 m	kW	A	A	No.	+°C	+°C	kg	Type	Ref. no.	Type	Ref. no.	Type	Ref. no.
3 Phase motor, 3~, 400 V, 50 Hz, Y/Δ wiring, protection to IP 55																	
GBD 710/4	5529	20285	1465	51	5.97	10.20	—	499	70	—	170	—	—	—	—	MD	5849
2 speed motor, 3 Phase motor, 400 V / 3 ph. / 50 Hz, Y/Δ wiring, protection to IP 54																	
GBD 710/6/6	5525	16500/19000	690/890	46	1.55/2.45	2.90/4.70	4.70	867	50	50	157	RDS 7	1578	TSD 7,0	1504	MD	5849
3 Phase motor, 3~, 400 V, 50 Hz, protection to IP 54																	
GBD 710/4 T120	5756	18200	1465	55	5,89	10.4	—	499	120	—	188	—	—	—	—	MD	5849

GBD 710/4

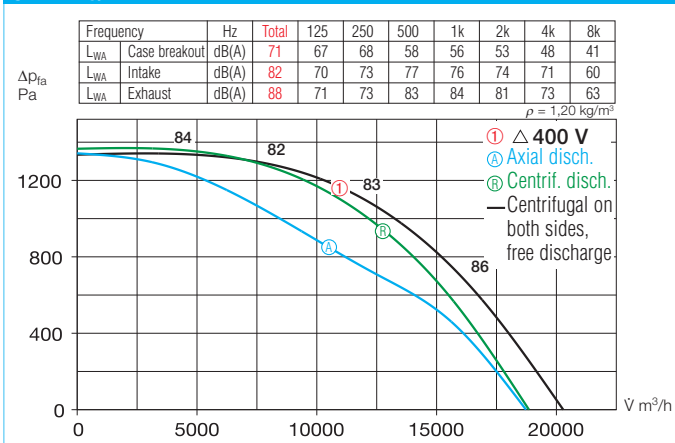

GBD 710/4 T120

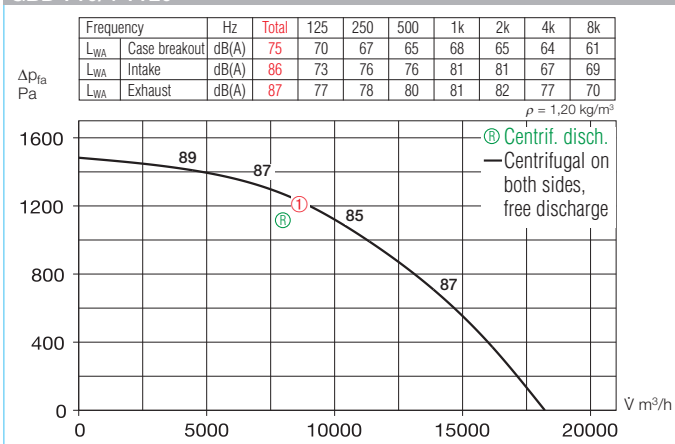

GBD 710/6/6

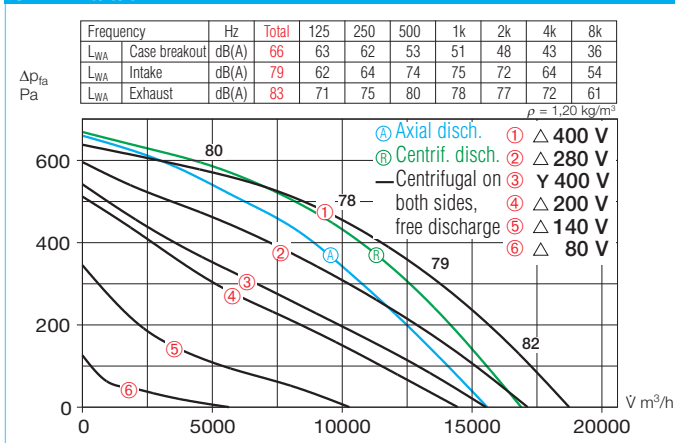

Motor protection

Types GBD with thermal contacts embedded on the terminal strip, which must be wired with the full motor protection device. Type GBD T120 with PTC thermistor for direct wiring with the full motor protection device or frequency inverter FU-BS (see table below, accessories).

Speed control

All types (except GB T120) are speed controllable by voltage reduction using a transformer controller. The 3-phase models can also be 2 speed controlled by Y/ Δ switch or full motor protection unit M4; Type GBD T120 is exclusively controllable via frequency inverter with Sine filter. The duties at different speeds are given in the performance curve.

Sound levels

Total sound power levels and the spectrum figures in dB(A) are given for:

- Sound level case breakout
 - Sound level intake
 - Sound level exhaust
- In the table below as well as underneath the performance curve you can find additionally the sound pressure levels at 4 m (free field conditions).

Accessories of both types

Anti vibration mounts for installation indoors. Set of 4.

SDD-U Ref. no. 5627

External weather louvers to cover exhaust opening.

GB-WSG 710 Ref. no. 5641

Outdoor cover hood for outdoor installation.

GB-WSD 710 Ref. no. 5750

Specific accessories

for types GB

Condensate collector with condensate spigot for pipe connection.

GB-KW 710 Ref. no. 5646

(Condensate collector with condensate spigot included in delivery with GB T120).

On/Off and 2-speed switch for 3-phase Y/ Δ motors.

Type DS 2¹⁾ Ref. no. 1351

¹⁾ full motor protection unit recommended: MD Ref. No. 5849

for types GB T120

Rain drainage for outdoor installation (drill holes for rain drainage is already prepared).

GB-RA Ref. no. 9418

Information	Page
Information for planning	10 on General techn. information, speed control
Accessory-Details	Page
Speed controller and full motor protection unit	525 on

■ **Application**

Noise-encapsulating centrifugal fans with retractable motor impeller unit and motor located outside the air flow. Suitable for rough operating conditions and to convey hot (up to +100 °C, types MBD EC to +120 °C) and damp air containing dirt and grease against high resistances. Ideal as an exhaust air fan for commercial kitchen extractor hoods.

□ **MB EC**

Optional MegaBox types with EC motor technology are available for energy-saving use and very low operating costs.

■ **Casing**

□ **MB 315 – 400 and MB Ex**

Dual-walled, made of galvanised sheet steel. Soundproof thanks to 50 mm thick mineral wool insulating board lining. Connecting duct pieces on the intake and exhaust side with rubber lip seal, coordinated to the standard diameter. Motor impeller unit is fully retractable for inspection and cleaning, suspended on stable hinges. Including mounting rails made of galvanised steel with screwed-on vibration dampers for easy installation.

□ **MB 225 – 280 and MB EC**

As with the MD, but 30 mm thick mineral wool insulating board lining. With condensate drain and drip protection when the doors are open as standard.

■ **Impellers**

High-performance centrifugal impellers with a high degree of efficiency. All types are curved backwards and made of aluminium, MB EC 225 to 250 are made of galvanised steel. In the MB Ex range onwards, they will be curved forwards and made of galvanised steel. Dynamically balanced according to DIN ISO 1940 T.1 – grade 6.3.

■ **Motor**

□ **MB**

Low-maintenance squirrel cage motor with IEC dimensions according to DIN EN 60034/VDE 0530 and DIN EN 60335-1/VDE 0700-1 and other prevalent standards. With flange mounting and self-ventilation. Thermal overload protection provided by thermal contacts built into the winder. Suitable for continuous operation S1. Insulation class F. Closed casing, IP 55.

□ **MB EC**

Energy-saving, speed-controlled IC internal rotor motor with degree of protection IP 55 with maximum efficiency, located outside the air flow. Low-maintenance and interference-free, ball bearing mounted.

■ **Speed control**

□ **MB**

The speed can be controlled in all types (excluding explosion protected types) by reducing the voltage using the transformer controller. The alternating current types can also be operated at two speeds by star delta connection or full motor protection devices. The performance can therefore be adjusted according to demand and optimally tailored to the desired operating point. The speed controllers on offer can operate one or more fans until the maximum nominal current is reached. A 10% power reserve is to be provided when sizing the speed controller.

□ **MB EC**

All EC types can be seamlessly controlled using a speed potentiometer. Furthermore, regulation with three-level switches or seamless regulation is possible using a universal control system or electronic differential pressure/temperature controller. Sample power levels are shown in the characteristic curve.

■ **Electrical connection**

Terminal boxes as standard with cables, degree of protection IP 55. When cutting the connecting cable to length, the pivot range of the motor impeller unit is to be taken into account. In MBD 315/2/2, 355/2/2 and 400/2/2 the terminal box is outside on the motor.

■ **Motor protection**

□ **MB**

Thermal contacts on the terminal strip, which are wired to the full motor protection device from the terminal strip.

□ **MB EC**

Integrated electronic temperature monitoring for EC motor and electronics. If the maximum permitted motor temperature is exceeded, in 3 ph. types the speed is automatically reduced and is once again controlled to reach the originally set value after it cools down. For 1 ph. types the motor is turned off if the maximum permitted temperature is exceeded.

■ **Explosion protection**

The types with explosion protection are in line with equipment group II, category 2G for operation in zone 1 and 2 in accordance with Directive 2014/34/EU (ATEX).

■ **Airflow direction**

The airflow direction cannot be changed in centrifugal fans. The correct direction of motor rotation is marked by arrows on the motor and is to be checked upon commissioning.

■ **Incorrect direction of rotation**

Operating the device in an incorrect direction of rotation overloads the AC motor and trips the thermal contacts. Typical concomitant features include: Low air flow capacity, vibration and abnormal sound.

■ **Air flow temperature**

The maximum permitted air flow temperature is shown in the type table.

■ **Ambient temperature**

From –40 °C to +40 °C.

■ **Installation position, mounting**

During positioning, the pivot range and weight of the motor impeller unit must be taken into account, as well as the ease of accessibility.

■ **Transfer of structure-born sound**

is to be prevented on the building and ducting system. The fan must not be rigidly connected to the ducting; flexible sleeves (type FM, accessory) are to be used.

Information	Page
Information for planning, Acoustics	10 on
General techn. information, Speed control	15 on
Other accessories	Page
Flexible sleeve	232
Speed controller and full motor protection unit	525 on
Universal control system, electronic controller, speed-potentiometer for MB EC types	539 on

By combining the parameters of static pressure increase Δp_{ia} , case breakout and intake air noise as sound pressure at 1 m

(free field conditions), the following table facilitates the selection of MegaBox centrifugal fans.

Type	Sound press. case breakout	Sound press. intake	Air flow volume $\dot{V} \text{ m}^3/\text{h}$ in relation to static pressure												
	L_{PA} dB(A)	L_{PA} dB(A)	(ΔP_{ia}) in Pa												
	at 1 m	at 1 m	0	50	100	200	300	400	500	600	700	800	1000	1500	2000
MBW EC 225	55	66	1350	1238	1250	1123	1000	878	764	500					
MBW EC 250	56	73	1900	1815	1730	1560	1420	1270	1125	985	800				
MBW EC 280	56	71	2620	2550	2475	2320	2150	1945	1680	1380	1000	545			
MBD EC 280	58	75	3000	2940	2860	2740	2625	2440	2300	2140	1945	1625	900		
MBW EC 315	50	62	2150	2035	1915	1620	1000								
MBD EC 315 A	59	73	3400	3320	3235	3080	2920	2740	2550	2270	1900	1380			
MBD EC 315 B	65	81	4200	4140	4065	3920	3800	3670	3530	3380	3220	3090	2700		
MBW EC 355	54	69	3050	2920	2790	2470	2080	1350							
MBD EC 355 A	66	78	5000	4890	4830	4680	4550	4380	4240	4045	4100	3530	2914		
MBD EC 355 B	68	82	5600	5520	5450	5255	5130	4940	4770	4640	4470	4300	3850	2210	
MBD EC 400 A	68	80	5000	4890	4760	4565	4370	4130	3870	3520	3050	2200			
MBD EC 400 B	72	85	6550	6475	6400	6300	6160	6000	5800	5550	5350	5100	4550	2525	

Type	Sound press. case breakout	Sound press. intake	Air flow volume $\dot{V} \text{ m}^3/\text{h}$ in relation to static pressure												
	L_{PA} dB(A)	L_{PA} dB(A)	(ΔP_{ia}) in Pa												
	at 1 m	at 1 m	0	50	100	200	300	400	500	600	700	800	1000	1500	2000
MBD 160/4 Ex	48	64	960	850	730										
MBD 160/2 Ex	63	79	2020	1970	1920	1820	1700	1570	1420	1270	1110				
MBD 180/4 Ex	51	67	1390	1290	1180	860									
MBD 200/4 Ex	54	70	*	*	1840	1530	1080								
MBW 225/2	52	64	1170	1130	1090	1010	920	800	640	370					
MBD 225/2/2	52	65	1170	1130	1090	1000	900	790	650	310					
MBD 225/4 Ex	56	74	*	2720	2570	2250	1840	940							
MBW 250/2	55	68	1620	1580	1530	1430	1320	1200	1040	850	510				
MBD 250/2/2	56	68	1590	1550	1510	1430	1330	1210	1050	860	250				
MBD 250/4 Ex	62	78	4130	3990	3840	3520	3150	2670	1950						
MBD 280/2/2	60	75	2520	2470	2420	2320	2190	2040	1880	1710	1510	1250			
MBD 280/6 Ex	56	72	*	*	3240	2740									
MBD 280/4 Ex	65	81	*	*	*	*	4800	4410	3900	3150					
MBW 315/4	41	61	1950	1820	1640	1270	820								
MBD 315/4/4	41	61	1990	1860	1720	1310	910								
MBD 315/2/2	64	80	3980	3910	3820	3660	3450	3500	3050	2750	2630	2440	2090	800	
MBW 355/4	43	60	2810	2660	2520	2070	1630	1140							
MBD 355/4/4	42	60	2850	2660	2440	2070	1650	1200							
MBD 355/2/2	68	84	5800	5770	5680	5480	5280	5030	4800	4570	4390	4160	3700	2700	
MBW 400/4	48	70	3550	3360	3170	2800	2470	2090	1640	750					
MBD 400/4/4	50	69	3440	3290	3140	2800	2460	2100	1630	720					
MBD 400/2/2	74	90	7500	7380	7270	7070	6830	6660	6480	6310	6130	5990	5610	4730	3500

* Consider necessary minimum system resistance.

MB EC

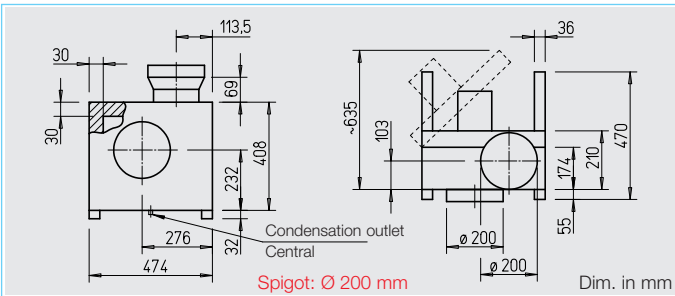

MBW EC 225

Frequency		Hz	Total	125	250	500	1k	2k	4k	8k
L _{WA}	Case breakout	dB(A)	63	47	50	52	58	57	51	41
L _{WA}	Intake	dB(A)	74	52	65	70	68	65	64	62
L _{WA}	Exhaust	dB(A)	77	53	64	73	67	70	66	61

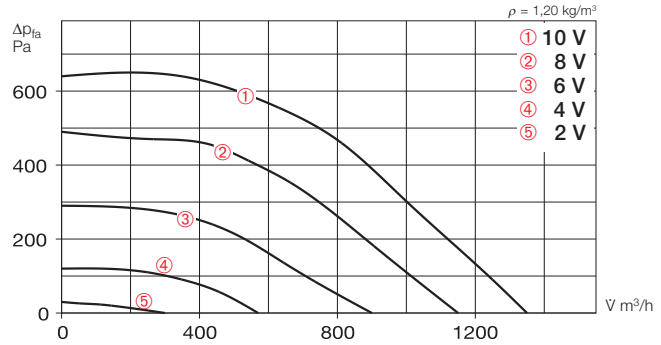

Free discharge						
Voltage V	n min ⁻¹	V̇ m³/h	P W	I A	Lp dB(A)	SFP kW/m³/s
10	3000	1350	230	1,00	55	0,61
8	2600	1150	150	0,68	52	0,47
6	2000	900	90	0,42	47	0,34
4	1300	570	50	0,27	38	0,25



Casing

Acoustically lined double skinned galvanised steel casing with 30 mm thick mineral fibre-board. Swing out motor and impeller unit, fixed with robust die-cast hinges. Intake and exhaust spigots with twin-seal rubber gasket. Condensation drain and drip protection with the door opened as standard. Easy installation with 2 sturdy mounting rails, manufactured from galvanised steel complete with anti vibration mounts.

Impeller

Backward curved high output centrifugal-impeller, made from galvanised steel, mounted directly to the motor shaft. High efficiency, low noise level. Dynamically balanced to DIN ISO 1940 Pt.1 – class 6.3.

Motor

Energy-saving, speed controllable EC-internal rotor motor with highest efficiency, out of the air stream, protection to IP 55. With ball bearings, maintenance-free and interference-free.

Electrical connection

Standard terminal box (IP 55) is mounted with a permanently attached cable.

Motor protection

Integrated electronic temperature monitoring for EC-motor and electronics. During exceedance of the maximum permitted temperatures an automatic speed-/performance adjustment is carried out.

Speed control

Stepless speed control with potentiometer or stepless speed control with universal control system (see table). Duties at different speeds are exemplarily given in the performance curve.

Sound levels

Total sound power levels and the spectrum figures in dB(A) are given for:
 – Sound level case breakout
 – Sound level intake
 – Sound level exhaust
 In the table below as well as underneath the performance curve you can find additionally the sound pressure level at 1 m (free field conditions).

Accessories

Wall bracket from galv. sheet steel
Type MB-WK EC225 No. 5526

Rain repellent roof from galv. sheet steel, mounting above the motor.
Type MB-WSD EC225 No. 1856

Flexible sleeve for installation between fan and ducting.
 – max. temperature +70 °C
Type FM 200 No. 1670
 – max. temperature +120 °C
Type FM 200 T120 No. 1654

Accessory details	Page
Universal control system, electronic controller, speed-potentiometer	539 on

Type	Ref. no.	Connection Ø	Air flow volume (FID)	R.P.M.	Sound press. case breakout	Motor power	Current	Wiring diagram	max. air flow temperature	Weight net approx.	Universal control system	Speed-potentiometer flush	Speed-potentiometer surface
		mm	V̇ m³/h	min ⁻¹	dB(A) in 1 m	kW	A	No.	+ °C	kg	Type Ref. no.	Type Ref. no.	Type Ref. no.
1 ph. motor, 1~, 230 V, 50/60 Hz, EC motor, protection to IP 55													
MBW EC 225	5842	200	1350	3000	55	0.27	1.20	985	100	25	EUR EC ^{1) 2)} 1347	PU 10 ¹⁾ 1734	PA 10 ¹⁾ 1735

1) several EC fans can normally be connected 2) alternative electronic differential pressure/temp. controller (EDR/ETR, No. 1437/1438) or three-step speed controller (SU/SA, No. 4266/4267), see accessories

MB EC

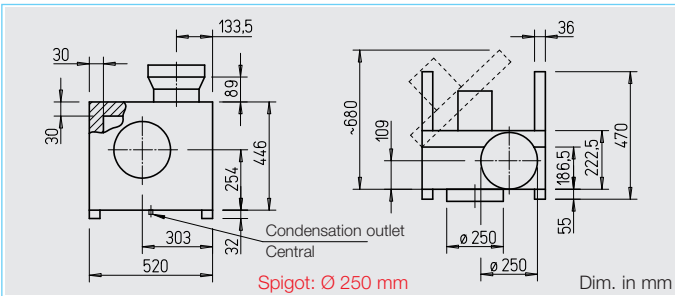

MBW EC 250

Frequency	Hz	total	125	250	500	1k	2k	4k	8k
L _{WA} Case breakout	dB(A)	64	43	52	60	56	57	52	46
L _{WA} Intake	dB(A)	81	62	72	77	75	72	71	66
L _{WA} Exhaust	dB(A)	83	62	71	79	75	76	71	65

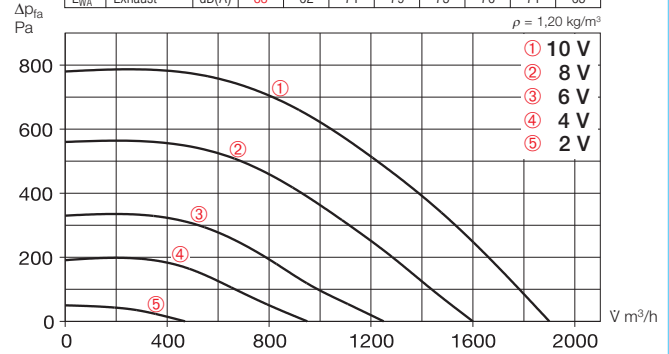

Voltage V	Free discharge					
	n min ⁻¹	V̇ m³/h	P W	I A	Lp dB(A)	SFP kW/m²/s
10	3000	1900	310	1,3	56	0,59
8	2600	1600	200	0,90	51	0,45
6	2000	1250	110	0,51	47	0,32
4	1500	950	70	0,4	42	0,25

EC box fans

□ Casing

Acoustically lined double skinned galvanised steel casing with 30 mm thick mineral fibre-board. Swing out motor and impeller unit, fixed with robust die-cast hinges. Intake and exhaust spigots with twin-seal rubber gasket. Condensation drain and drip protection with the door opened as standard. Easy installation with 2 sturdy mounting rails, manufactured from galvanised steel complete with anti vibration mounts.

□ Impeller

Backward curved high output centrifugal-impeller, made from galvanised steel, mounted directly to the motor shaft. High efficiency, low noise level. Dynamically balanced to DIN ISO 1940 Pt.1 – class 6.3.

□ Motor

Energy-saving, speed controllable EC-internal rotor motor with highest efficiency, out of the air stream, protection to IP 55. With ball bearings, maintenance-free and interference-free.

□ Electrical connection

Standard terminal box (IP 55) is mounted with a permanently attached cable.

□ Motor protection

Integrated electronic temperature monitoring for EC-motor and electronics. During exceedance of the maximum permitted temperatures an automatic speed-/performance adjustment is carried out.

□ Speed control

Stepless speed control with potentiometer or stepless speed control with universal control system (see table). Duties at different speeds are exemplarily given in the performance curve.

■ Sound levels

Total sound power levels and the spectrum figures in dB(A) are given for:

- Sound level case breakout
- Sound level intake
- Sound level exhaust

In the table below as well as underneath the performance curve you can find additionally the sound pressure level at 1 m (free field conditions).

■ Accessories

Wall bracket from galv. sheet steel
Type MB-WK EC250 No. 5526

Rain repellent roof from galv. sheet steel, mounting above the motor.
Type MB-WSD EC250 No. 1856

Flexible sleeve for installation between fan and ducting.
 – max. temperature +70 °C
Type FM 250 No. 1672
 – max. temperature +120 °C
Type FM 250 T120 No. 1655

Accessory details	Page
Universal control system, electronic controller, speed-potentiometer	539 on

Type	Ref. no.	Connection Ø	Air flow volume (FID)	R.P.M.	Sound press. case breakout	Motor power	Current	Wiring diagram	max. air flow temperature	Weight net approx.	Universal control system	Speed-potentiometer flush	Speed-potentiometer surface
		mm	V m³/h	min ⁻¹	dB(A) in 1 m	kW	A	No.	+ °C	kg	Type Ref. no.	Type Ref. no.	Type Ref. no.
1 ph. motor, 1~, 230 V, 50/60 Hz, EC motor, protection to IP 55													
MBW EC 250	5843	250	1900	3000	56	0.38	1.70	985	100	28.0	EUR EC 1 ²⁾ 1347	PU 10 1 ¹⁾ 1734	PA 10 1 ¹⁾ 1735

1) several EC fans can normally be connected 2) alternative electronic differential pressure/temp. controller (EDR/ETR, No. 1437/1438) or three-step speed controller (SU/SA, No. 4266/4267), see accessories

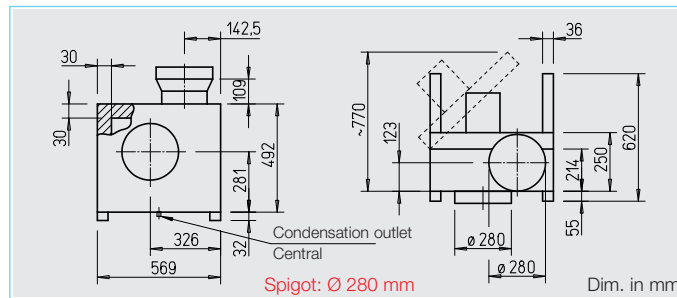

Casing

Acoustically lined double skinned galvanised steel casing with 30 mm thick mineral fibre-board. Swing out motor and impeller unit, fixed with robust die-cast hinges. Intake and exhaust spigots with twin-seal rubber gasket. Condensation drain and drip protection with the door opened as standard. Easy installation with 2 sturdy mounting rails, manufactured from galvanised steel complete with anti vibration mounts.

Impeller

Backward curved, free-running high-performance centrifugal impeller made from aluminium, mounted directly to the motor shaft. High efficiency, low noise level. Dynamically balanced to DIN ISO 1940 Pt.1 – class 6.3.

Motor

Energy-saving, speed controllable EC-internal rotor motor with highest efficiency, out of the air stream, protection to IP 55. With ball bearings, maintenance-free and interference-free.

Electrical connection

Standard terminal box (IP 55) mounted on outside of motor, with a permanently attached cable for 1~ type.

Motor protection

Integrated electronic temperature monitoring for EC-motor and electronics. During exceedance of the maximum permitted temperatures an automatic reduction of speed is carried out for 3~ type which is reset to the original set value after cooling. For 1~ type, the motor is switched off when the maximum permitted temperature is exceeded.

Speed control

Stepless speed control with potentiometer or stepless speed control with universal control system (see table). Duties at different speeds are exemplarily given in the performance curve.

Sound levels

Total sound power levels and the spectrum figures in dB(A) are given for:

- Sound level case breakout
- Sound level intake
- Sound level exhaust

In the table below as well as underneath the performance curve you can find additionally the sound pressure level at 1 m (free field conditions).

Type	Ref. no.	Connection Ø	Air flow volume (FID)	R.P.M.	Sound press. case breakout	Motor power	Current	Wiring diagram	max. air flow temperature	Weight net approx.	Universal control system		Speed-potentiometer			
											Type	Ref. no.	Type	Ref. no.	Type	Ref. no.
1 ph. motor, 1~, 230 V, 50/60 Hz, EC motor, protection to IP 55																
MBW EC 280	5850	280	2630	2450	56	0.48	2.10	985	100	33.0	EUR EC ¹⁾²⁾	1347	PU 10 ¹⁾	1734	PA 10 ¹⁾	1735
3 ph. motor 3~, 400 V, 50/60 Hz, EC motor, protection to IP 55																
MBD EC 280	5845	280	3000	3000	58	0.75	1.40	988	120	34.0	EUR EC ¹⁾²⁾	1347	PU 10 ¹⁾	1734	PA 10 ¹⁾	1735

1) several EC fans can normally be connected 2) alternative electronic differential pressure/temp. controller (EDR/ETR, No. 1437/1438) or three-step speed controller (SU/SA, No. 4266/4267), see accessories

MBW EC 280

Frequency	Hz	Total	125	250	500	1k	2k	4k	8k
L _{WA} Case breakout		dB(A) 64	51	60	57	53	56	52	47
L _{WA} Intake		dB(A) 79	57	74	73	69	68	70	65
L _{WA} Exhaust		dB(A) 83	59	77	78	73	74	71	66

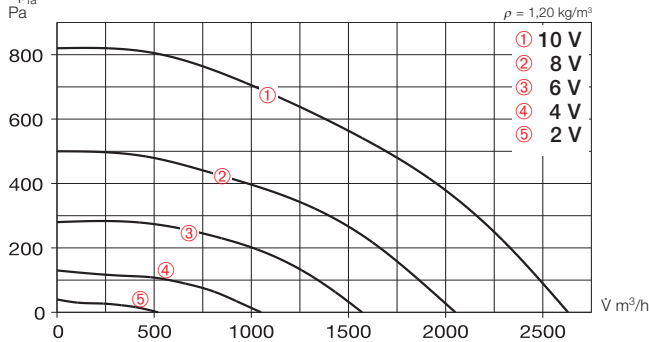

Free discharge						
Voltage V	n min ⁻¹	V̇ m ³ /h	P W	I A	Lp dB(A)	SFP kW/m ² /s
10	2450	2630	430	1,90	56	0,59
8	2000	2050	220	0,95	52	0,39
6	1500	1570	100	0,42	46	0,23
4	1000	1030	40	0,2	40	0,14

MBD EC 280

Frequency	Hz	Total	125	250	500	1k	2k	4k	8k
L _{WA} Case breakout		dB(A) 66	56	59	61	54	56	52	42
L _{WA} Intake		dB(A) 83	63	73	81	76	73	73	70
L _{WA} Exhaust		dB(A) 88	66	78	87	79	79	70	70

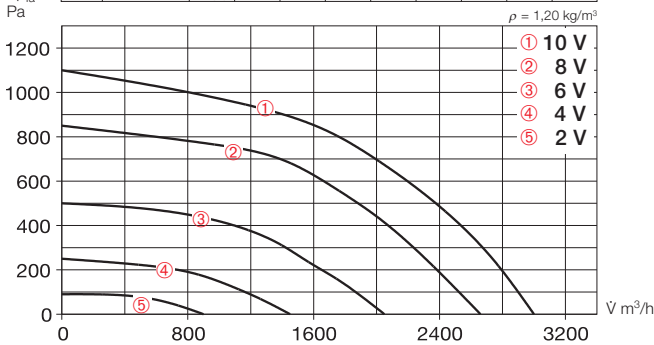

Free discharge						
Voltage V	n min ⁻¹	V̇ m ³ /h	P W	I A	Lp dB(A)	SFP kW/m ² /s
10	3000	3000	620	1,2	58	0,75
8	2600	2660	450	0,9	55	0,61
6	2000	2050	230	0,5	50	0,41
4	1400	1450	100	0,3	43	0,25

Accessories

Wall bracket

Bracket for wall installation, from galvanised sheet steel.

Type MB-WK EC280 No. 5527



Rain repellent roof

For protected outdoor installation. Made from galvanised sheet steel, Mounted above motor.

Type MB-WSD EC280 No. 1856

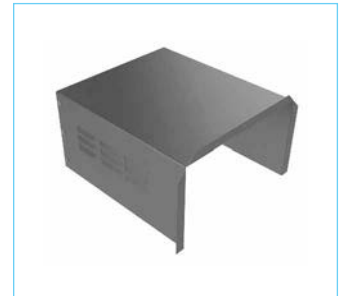

Flexible sleeve

Supplied with two hose clips as standard; for installation between fan and duct system. Prevents sound and vibration transmission to ducting and corrects small site misalignments.

– max. temperature +70 °C

Type FM 280 No. 1673

– max. temperature +120 °C

Type FM 280 T120 No. 1656

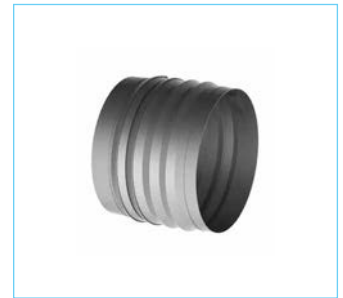

Universal control system

Type EUR EC Ref. no. 1347

For stepless control or regulation of single and three-phase EC fans with a setpoint input of 0–10 V DC.



Speed-potentiometer

For direct control/setpoint specification for EC fans with potentiometer input.

Type PU 10 Ref. no. 1734

for flush mounted installation.

Type PA 10 Ref. no. 1735

for surface mounted installation.



Accessory details Page

Universal control system, electronic controller, speed-potentiometer 539 on

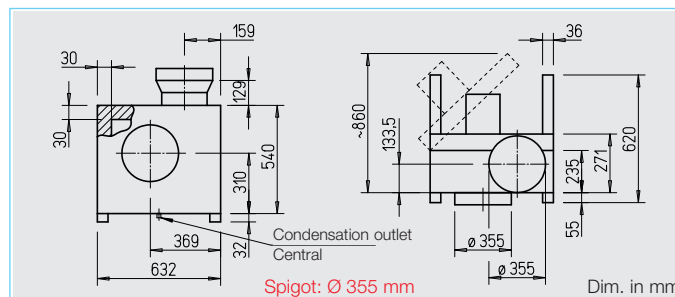

Casing

Acoustically lined double skinned galvanised steel casing with 30 mm thick mineral fibre-board. Swing out motor and impeller unit, fixed with robust die-cast hinges. Intake and exhaust spigots with twin-seal rubber gasket. Condensation drain and drip protection with the door opened as standard. Easy installation with 2 sturdy mounting rails, manufactured from galvanised steel complete with anti vibration mounts.

Impeller

Backward curved, free-running high-performance centrifugal impeller made from aluminium, mounted directly to the motor shaft. High efficiency, low noise level. Dynamically balanced to DIN ISO 1940 Pt.1 – class 6.3.

Motor

Energy-saving, speed controllable EC-internal rotor motor with highest efficiency, out of the air stream, protection to IP 55. With ball bearings, maintenance-free and interference-free.

Electrical connection

Standard terminal box (IP 55) mounted on outside of motor, with a permanently attached cable for 1~ type.

Motor protection

Integrated electronic temperature monitoring for EC-motor and electronics. During exceedance of the maximum permitted temperatures an automatic reduction of speed is carried out for 3~ types which is reset to the original set value after cooling. For 1~ type, the motor is switched off when the maximum permitted temperature is exceeded.

Speed control

Stepless speed control with potentiometer or stepless speed control with universal control system (see table). Duties at different speeds are exemplarily given in the performance curve.

Sound levels

Total sound power levels and the spectrum figures in dB(A) are given for:

- Sound level case breakout
 - Sound level intake
 - Sound level exhaust
- In the table below as well as underneath the performance curve you can find additionally the sound pressure level at 1 m (free field conditions).

Type	Ref. no.	Connection Ø	Air flow volume (FID)	R.P.M.	Sound press. case breakout	Motor power	Current	Wiring diagram	max. air flow temperature	Weight net approx.	Universal control system		Speed-potentiometer			
											Type	Ref. no.	Type	Ref. no.	Type	Ref. no.
1 ph. motor, 1~, 230 V, 50/60 Hz, EC motor, protection to IP 55																
MBW EC 315	5852	355	2150	1500	50	0.20	0.85	985	100	43.0	EUR EC ¹⁾²⁾	1347	PU 10 ¹⁾	1734	PA 10 ¹⁾	1735
3 ph. motor 3~, 400 V, 50/60 Hz, EC motor, protection to IP 55																
MBD EC 315 A	5851	355	3400	2400	59	0.72	1.30	988	120	44.0	EUR EC ¹⁾²⁾	1347	PU 10 ¹⁾	1734	PA 10 ¹⁾	1735
MBD EC 315 B	5846	355	4200	3000	65	1.38	2.20	988	120	50.0	EUR EC ¹⁾²⁾	1347	PU 10 ¹⁾	1734	PA 10 ¹⁾	1735

1) several EC fans can normally be connected 2) alternative electronic differential pressure/temp. controller (EDR/ETR, No. 1437/1438) or three-step speed controller (SU/SA, No. 4266/4267), see accessories

MBW EC 315

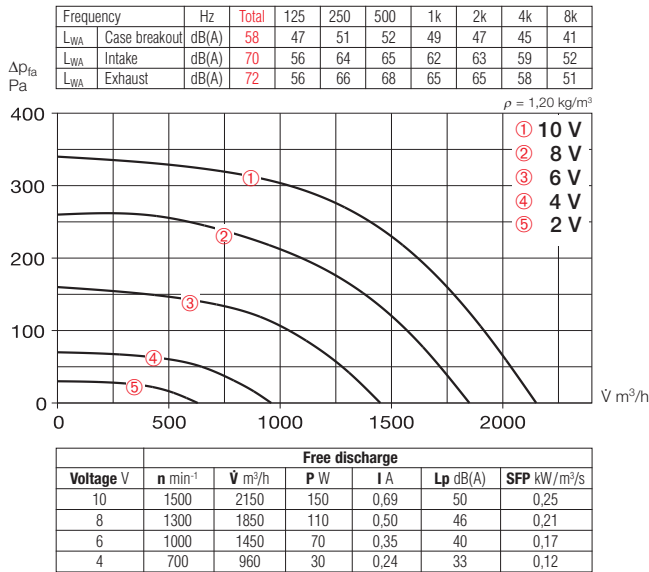

Accessories

Wall bracket

Bracket for wall installation, from galvanised sheet steel.

Type MB-WK EC315 No. 5527



Rain repellent roof

For protected outdoor installation. Made from galvanised sheet steel, Mounted above motor.

Type MB-WSD EC315 No. 1865

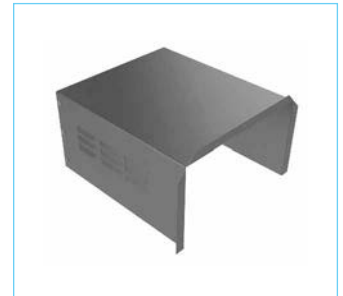

MBD EC 315 A

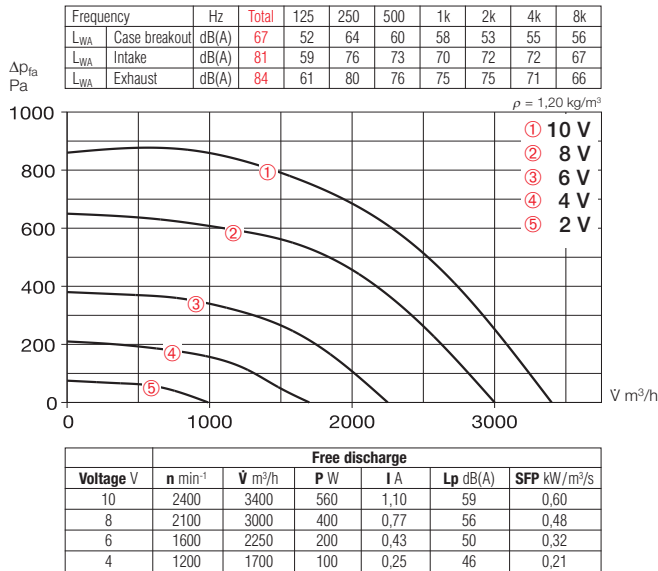

Flexible sleeve

Supplied with two hose clips as standard; for installation between fan and duct system. Prevents sound and vibration transmission to ducting and corrects small site misalignments.

– max. temperature +70 °C

Type FM 355 No. 1675

– max. temperature +120 °C

Type FM 355 T120 No. 1658



Universal control system

Type EUR EC Ref. no. 1347

For stepless control or regulation of single and three-phase EC fans with a setpoint input of 0–10 V DC.



MBD EC 315 B

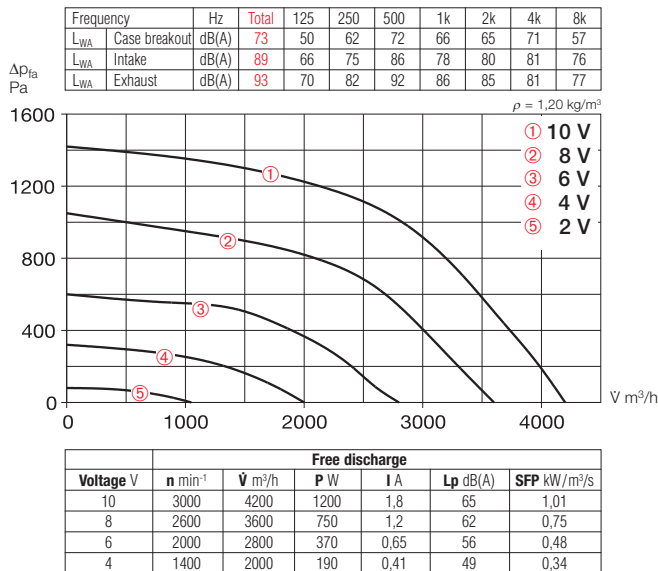

Speed-potentiometer

For direct control/setpoint specification for EC fans with potentiometer input.

Type PU 10 Ref. no. 1734 for flush mounted installation.

Type PA 10 Ref. no. 1735 for surface mounted installation.



Accessory details Page

Universal control system, electronic controller, speed-potentiometer 539 on

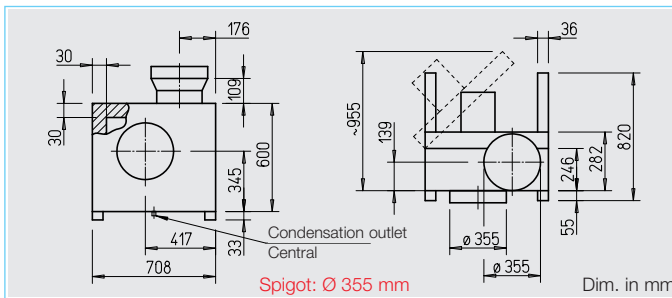

Casing

Acoustically lined double skinned galvanised steel casing with 30 mm thick mineral fibre-board. Swing out motor and impeller unit, fixed with robust die-cast hinges. Intake and exhaust spigots with twin-seal rubber gasket. Condensation drain and drip protection with the door opened as standard. Easy installation with 2 sturdy mounting rails, manufactured from galvanised steel complete with anti vibration mounts.

Impeller

Backward curved, free-running high-performance centrifugal impeller made from aluminium, mounted directly to the motor shaft. High efficiency, low noise level. Dynamically balanced to DIN ISO 1940 Pt.1 – grade 6.3.

Motor

Energy-saving, speed controllable EC-internal rotor motor with highest efficiency, out of the air stream, protection to IP 55. With ball bearings, maintenance-free and interference-free.

Electrical connection

Standard terminal box (IP 55) mounted on outside of motor, with a permanently attached cable for 1~ type.

Motor protection

Integrated electronic temperature monitoring for EC-motor and electronics. During exceedance of the maximum permitted temperatures an automatic reduction of speed is carried out for 3~ types which is reset to the original set value after cooling. For 1~ type, the motor is switched off when the maximum permitted temperature is exceeded.

Speed control

Stepless speed control with potentiometer or stepless speed control with universal control system (see table). Duties at different speeds are exemplarily given in the performance curve.

Sound levels

Total sound power levels and the spectrum figures in dB(A) are given for:

- Sound level case breakout
 - Sound level intake
 - Sound level exhaust
- In the table below as well as underneath the performance curve you can find additionally the sound pressure level at 1 m (free field conditions).

Type	Ref. no.	Connection Ø	Air flow volume (FID)	R.P.M.	Sound press. case breakout	Motor power	Current	Wiring diagram	max. air flow temperature	Weight net approx.	Universal control system		Speed-potentiometer			
											Type	Ref. no.	Type	Ref. no.	Type	Ref. no.
1 ph. motor, 1~, 230 V, 50/60 Hz, EC motor, protection to IP 55																
MBW EC 355	5854	355	3050	1500	54	0.33	1.50	985	100	50.0	EUR EC ¹⁾²⁾	1347	PU 10 ¹⁾	1734	PA 10 ¹⁾	1735
3 ph. motor 3~, 400 V, 50/60 Hz, EC motor, protection to IP 55																
MBD EC 355 A	5853	355	5000	2500	66	1.45	2.20	988	120	56.0	EUR EC ¹⁾²⁾	1347	PU 10 ¹⁾	1734	PA 10 ¹⁾	1735
MBD EC 355 B	5847	355	5600	2800	68	1.90	3.10	988	120	63.0	EUR EC ¹⁾²⁾	1347	PU 10 ¹⁾	1734	PA 10 ¹⁾	1735

1) several EC fans can normally be connected 2) alternative electronic differential pressure/temp. controller (EDR/ETR, No. 1437/1438) or three-step speed controller (SU/SA, No. 4266/4267), see accessories

MBW EC 355

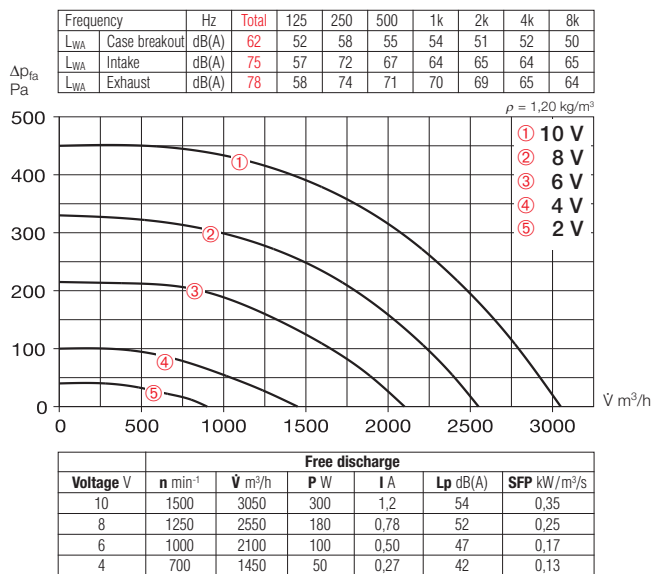

Accessories

Wall bracket

Bracket for wall installation, from galvanised sheet steel.

Type MB-WK EC355 No. 5528



Rain repellent roof

For protected outdoor installation. Made from galvanised sheet steel. Mounted above motor.

Type MB-WSD EC355 No. 1865



MBD EC 355 A

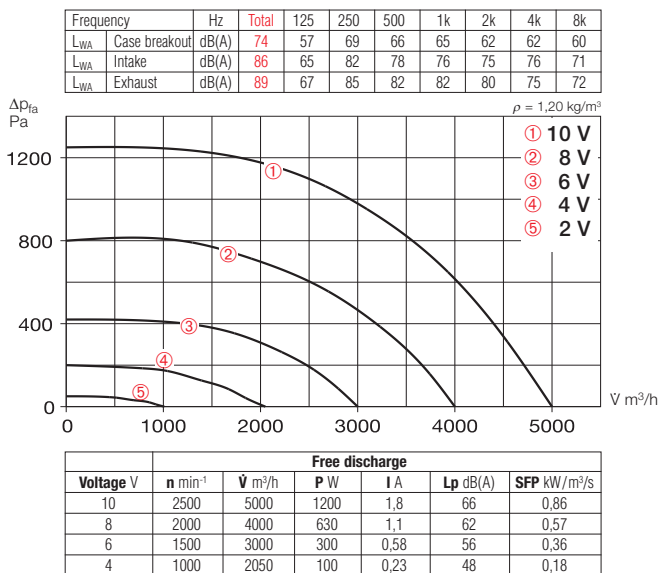

Flexible sleeve

Supplied with two hose clips as standard; for installation between fan and duct system. Prevents sound and vibration transmission to ducting and corrects small site misalignments.

– max. temperature +70 °C

Type FM 355 No. 1675

– max. temperature +120 °C

Type FM 355 T120 No. 1658



Universal control system

Type EUR EC Ref. no. 1347

For stepless control or regulation of single and three-phase EC fans with a setpoint input of 0–10 V DC.



MBD EC 355 B

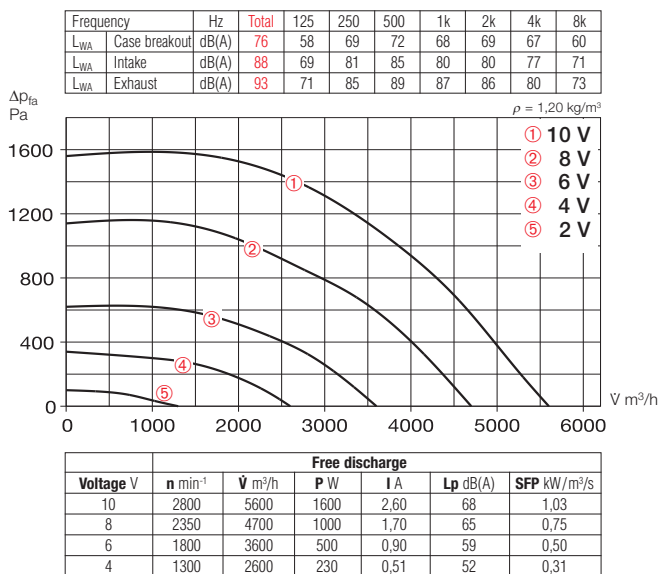

Speed-potentiometer

For direct control/setpoint specification for EC fans with potentiometer input.

Type PU 10 Ref. no. 1734

for flush mounted installation.

Type PA 10 Ref. no. 1735

for surface mounted installation.



Accessory details Page

Universal control system, electronic controller, speed-potentiometer 539 on

MB EC

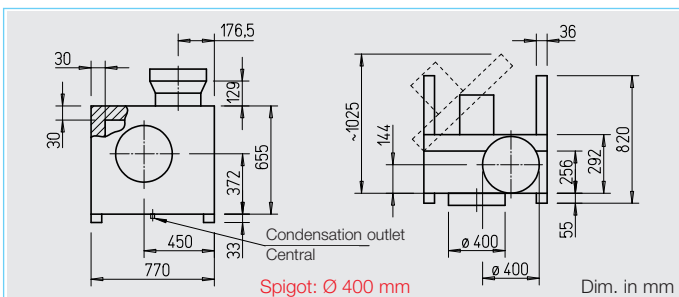

Casing

Casing, impeller, motor and sound levels see description on page 272.

Electrical connection

Standard terminal box (IP 55) on outside of motor.

Motor protection

Integrated electronic temperature monitoring for EC-motor and electronics. During exceedance of the maximum permitted temperatures an automatic reduction of speed is carried out, which is reset to the original set value after cooling.

Speed control

Stepless speed control with potentiometer or stepless speed control with universal control system (see table). Duties at different speeds are exemplarily given in the performance curve.

Accessories

Wall bracket

Made from galvanised sheet steel.
Type MB-WK EC400 No. 5528

Rain repellent roof

Made from galvanised sheet steel, Mounted above motor.
Type MB-WSD EC400 No. 1865

Flexible sleeve

for installation between fan and duct system.
– max. temperature +70 °C
Type FM 400 No. 1676
– max. temperature +120 °C
Type FM 400 T120 No. 1659

MBD EC 400 A

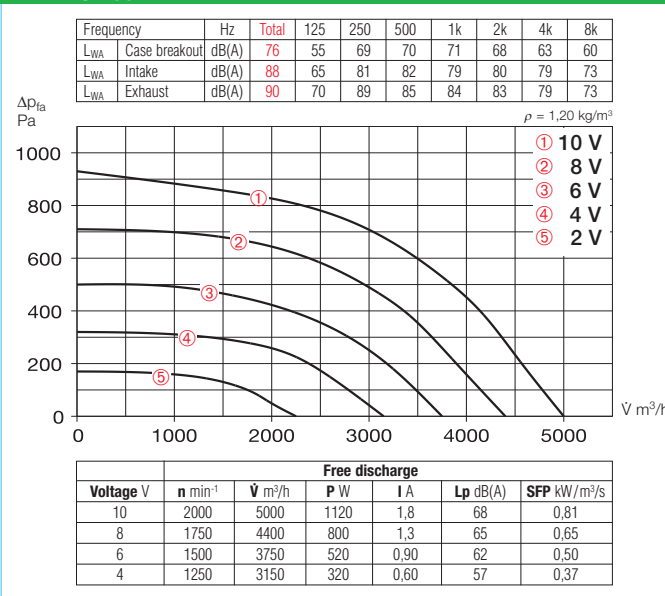

MBD EC 400 B

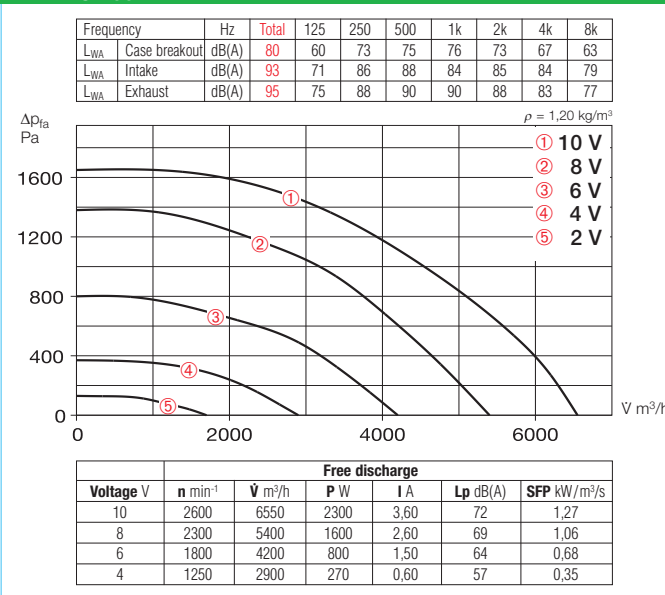

Type	Ref. no.	Connection Ø	Air flow volume (FID)	R.P.M.	Sound press. case breakout	Motor power	Current	Wiring diagram	max. air flow temperature	Weight net approx.	Universal control system		Speed-potentiometer flush		Speed-potentiometer surface	
											Type	Ref. no.	Type	Ref. no.	Type	Ref. no.
3 ph. motor 3~, 400 V, 50/60 Hz, EC motor, protection to IP 55																
MBD EC 400 A	5855	400	5000	2000	68	1.30	2.00	988	120	65.0	EUR EC ¹⁾²⁾	1347	PU 10 ¹⁾	1734	PA 10 ¹⁾	1735
MBD EC 400 B	5848	400	6550	2600	72	2.65	4.10	988	120	72.0	EUR EC ¹⁾²⁾	1347	PU 10 ¹⁾	1734	PA 10 ¹⁾	1735

¹⁾ several EC fans can normally be connected ²⁾ alternative electronic differential pressure/temp. controller (EDR/ETR, No. 1437/1438) or three-step speed controller (SU/SA, No. 4266/4267), see accessories

MB Ex

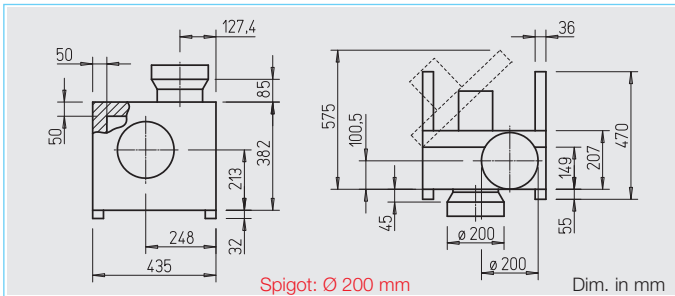

□ Casing

Acoustically lined double skinned galvanised steel casing with 50 mm thick mineral fibreboard. Swing out motor and impeller unit, fixed with robust die-cast hinges. Intake and exhaust spigots with twin-seal rubber gasket. Easy installation with 2 sturdy mounting rails, manufactured from galvanised steel complete with anti vibration mounts.

□ Impeller

Forward curved high-performance centrifugal impeller made from galvanised steel, together with the dynamically balanced motor. High efficiency, low noise, aerodynamically optimised volute casing.

□ Motor

Through maintenance-free IEC flange motor protected to IP 55. Ball bearing mounted, interference-free.

□ Electrical connection

Standard terminal box (IP 55) on outside of motor.

MBD 160/4 Ex

Frequency	Hz	Total	125	250	500	1k	2k	4k	8k
L _{WA} Case breakout	dB(A)	54	52	48	45	41	39	35	31
L _{WA} Intake	dB(A)	72	70	66	63	59	57	53	49
L _{WA} Exhaust	dB(A)	74	72	68	65	61	59	55	51

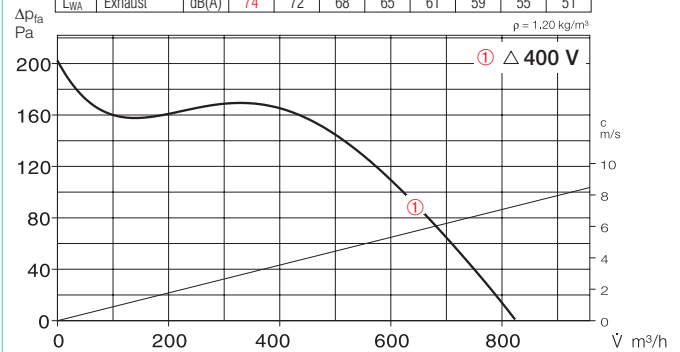

MBD 160/2 Ex

Frequency	Hz	Total	125	250	500	1k	2k	4k	8k
L _{WA} Case breakout	dB(A)	69	67	63	60	56	54	50	46
L _{WA} Intake	dB(A)	87	85	81	78	74	72	68	64
L _{WA} Exhaust	dB(A)	89	87	83	80	76	74	70	66

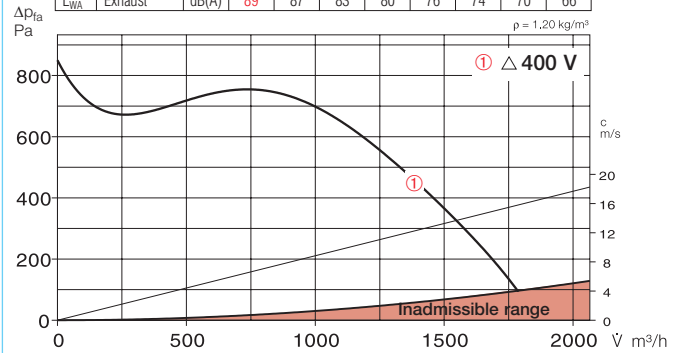

■ Accessories

Wall bracket
rom galvanised sheet steel.

Type MB-WK 160 No. 5526

Rain repellent roof

Made from galvanised sheet steel, Mounted above motor.

Type MB-WSD No. 1856

Flexible sleeve

for installation between fan and duct system.

Type FM 200 Ex No. 1686

■ Information

Techn. description, selection chart

Page

264 on

Type	Ref. no.	Air flow volume max.	R.P.M.	Sound press. case breakout	Motor power*	Current* full load	Current* speed control	Wiring diagram	max. air flow temperature at full load	Weight net approx.	5-step transformer with full motor protect.	speed controller without full motor protect.	Full motor protect. for connection of built-in therma cont.			
		\dot{V} m ³ /h	min ⁻¹	dB(A) in 1 m	kW	A	A	No.	+°C	+°C	Type	Ref. no.	Type	Ref. no.	Type	Ref. no.
Explosion-proof Ex e II, temp. class T1 – T3, 3 ph. motor 400 V, 50 Hz, protection to IP 55																
MBD 160/4 Ex	6001	970	1370	48	0.37	1.08	—	470	40	—	25.0	not permitted	not permitted	—	—	—
MBD 160/2 Ex	6002	2020	2840	63	1.50	3.15	—	470	40	—	34.0	not permitted	not permitted	—	—	—

* For Ex-types: Motor rated values, see Information p. 16

MB Ex

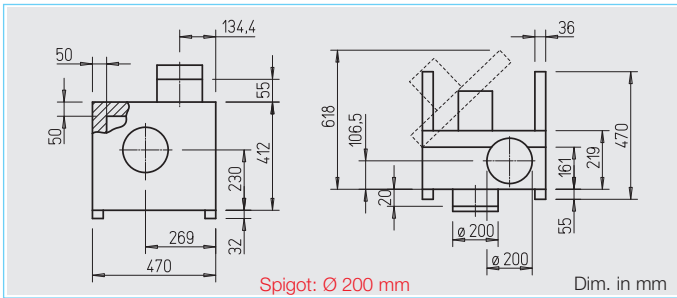

MBD 180/4 Ex

Frequency	Hz	Total	125	250	500	1k	2k	4k	8k	
L _{WA}	Case breakout	dB(A)	57	55	51	58	44	42	38	34
L _{WA}	Intake	dB(A)	75	73	69	66	62	60	56	52
L _{WA}	Exhaust	dB(A)	77	75	71	68	64	62	58	54

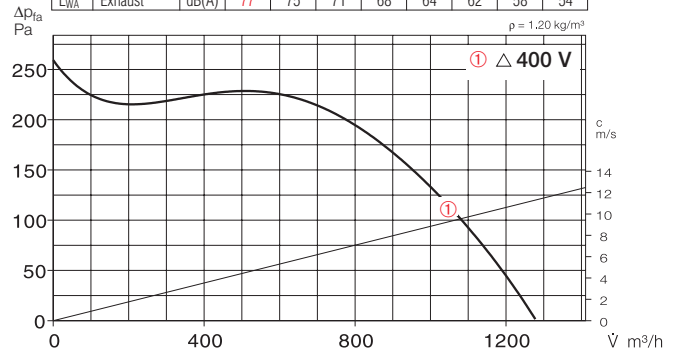

Casing

Acoustically lined double skinned galvanised steel casing with 50 mm thick mineral fibre-board. Swing out motor and impeller unit, fixed with robust die-cast hinges. Intake and exhaust spigots with twin-seal rubber gasket. Easy installation with 2 sturdy mounting rails, manufactured from galvanised steel complete with anti vibration mounts.

Impeller

Forward curved high-performance centrifugal impeller made from galvanised steel, together with the dynamically balanced motor. High efficiency, low noise, aerodynamically optimised volute casing.

Motor

Through maintenance-free IEC flange motor protected to IP 55. Ball bearing mounted, interference-free.

Electrical connection

Standard terminal box (IP 55) on outside of motor.

Accessories

Wall bracket

Made from galvanised sheet steel.
Type MB-WK 180 No. 5526

Rain repellent roof

Made from galvanised sheet steel, Mounted above motor.
Type MB-WSD No. 1856

Flexible sleeve

for installation between fan and duct system.
Type FM 200 Ex No. 1686

Information	Page
Techn. description, selection chart	264 on

Type	Ref. no.	Air flow volume max.	R.P.M.	Sound press. case breakout	Motor power*	Current* full load	Current* speed control	Wiring diagram	max. air flow temperature at full load	Weight net approx.	5-step transformer with full motor protect.	speed controller without full motor protect.	Full motor protect. for connection of built-in therma cont.			
		V̇ m³/h	min ⁻¹	dB(A) in 1 m	kW	A	A	No.	+°C	+°C	Type	Ref. no.	Type	Ref. no.	Type	Ref. no.
Explosion-proof Ex e II, temp. class T1 – T3, 3 ph. motor 400 V, 50 Hz, protection to IP 55																
MBD 180/4 Ex	6004	1370	1420	51	0.37	1.08	—	470	40	—	29.0	not permitted	not permitted	—	—	—

* For Ex-types: Motor rated values, see Information p. 16

MB Ex

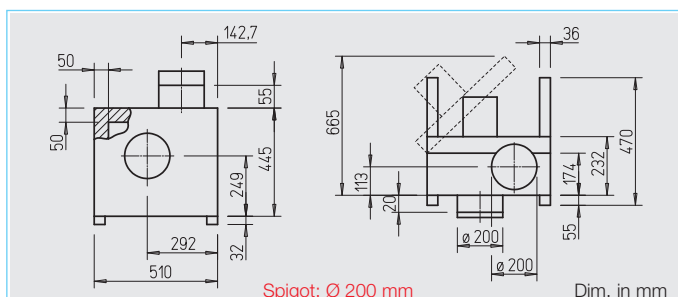

□ Casing

Acoustically lined double skinned galvanised steel casing with 50 mm thick mineral fibre-board. Swing out motor and impeller unit, fixed with robust die-cast hinges. Intake and exhaust spigots with twin-seal rubber gasket. Easy installation with 2 sturdy mounting rails, manufactured from galvanised steel complete with anti vibration mounts.

□ Impeller

Forward curved high-performance centrifugal impeller made from galvanised steel, together with the dynamically balanced motor. High efficiency, low noise, aerodynamically optimised volute casing.

□ Motor

Through maintenance-free IEC flange motor protected to IP 55. Ball bearing mounted, interference-free.

□ Electrical connection

Standard terminal box (IP 55) on outside of motor.

MBD 200/4 Ex

Frequency	Hz	Total	125	250	500	1k	2k	4k	8k
L _{WA} Case breakout	dB(A)	60	58	54	51	47	45	41	37
L _{WA} Intake	dB(A)	78	76	72	69	65	63	59	55
L _{WA} Exhaust	dB(A)	80	78	74	71	67	65	61	57

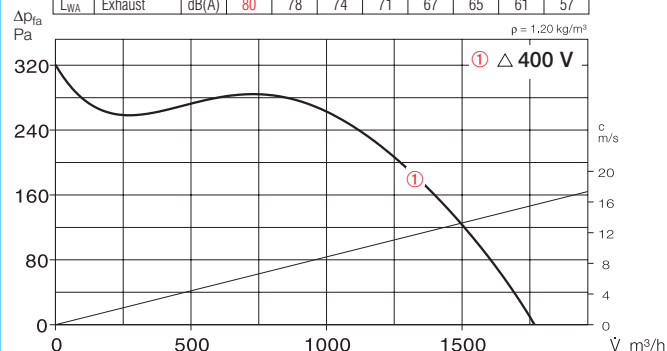

■ Accessories

Wall bracket

rom galvanised sheet steel.

Type MB-WK 200 No. 5526

Rain repellent roof

Made from galvanised sheet steel, Mounted above motor.

Type MB-WSD No. 1856

Flexible sleeve

for installation between fan and duct system.

Type FM 200 Ex No. 1686

■ Information

Page

Techn. description,
selection chart

264 on

Type	Ref. no.	Air flow volume max.	R.P.M.	Sound press. case breakout	Motor power*	Current* full load	Current* speed control	Wiring diagram	max. air flow temperature at full load	Weight net approx.	5-step transformer with full motor protect.	speed controller without full motor protect.	Full motor protect. for connection of built-in therma cont.			
		V m ³ /h	min ⁻¹	dB(A) in 1 m	kW	A	A	No.	+°C	+°C	Type	Ref. no.	Type	Ref. no.	Type	Ref. no.
Explosion-proof Ex e II, temp. class T1 – T3, 3 ph. motor 400 V, 50 Hz, protection to IP 55																
MBD 200/4 Ex	6008	1840	1430	54	0.55	1.36	—	470	40	—	35.0	not permitted	not permitted	—	—	—

* For Ex-types: Motor rated values, see Information p. 16

MB



(Fig. similar)

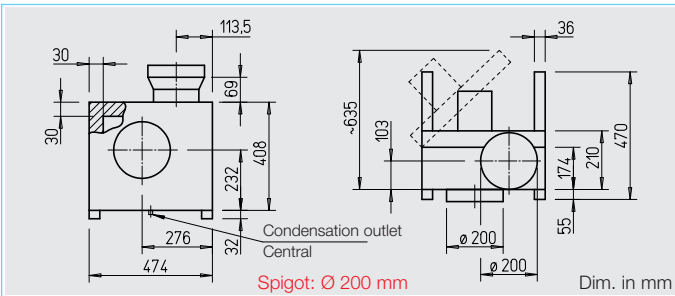

- Casing**
See page 264.
- Impeller**
Forward curved high-performance centrifugal impeller made from aluminium and forward curved made from galvanised steel for ex-proof types. Together with the dynamically balanced motor. High efficiency, low noise, aerodynamically optimised volute casing.
- Motor**
Through maintenance-free IEC flange motor protected to IP 55. Ball bearing mounted, interference-free.
- Electrical connection**
Standard terminal box (IP 55) mounted on running cable and outside of motor for ex-proof types.
- Motor protection**
Motors have thermal contacts wired to the terminal box and must be connected to a motor protection unit.
- Speed control**
See page 264.
- Accessories**
 - Wall bracket galv. sheet steel.**
Type MB-WK EC225 No. 5526
 - Wall bracket for Ex-types**
Type MB-WK 225 No. 5527
 - Rain repellent roof from galv. sheet steel.** Mounted above motor.
Type MB-WSD No. 1856

MBW 225/2

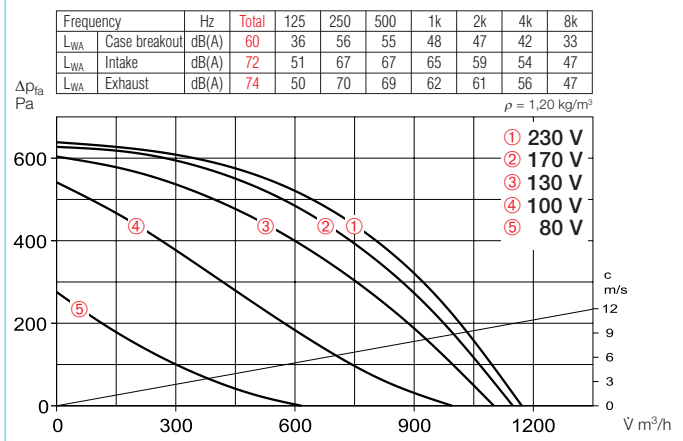

MBD 225/2/2

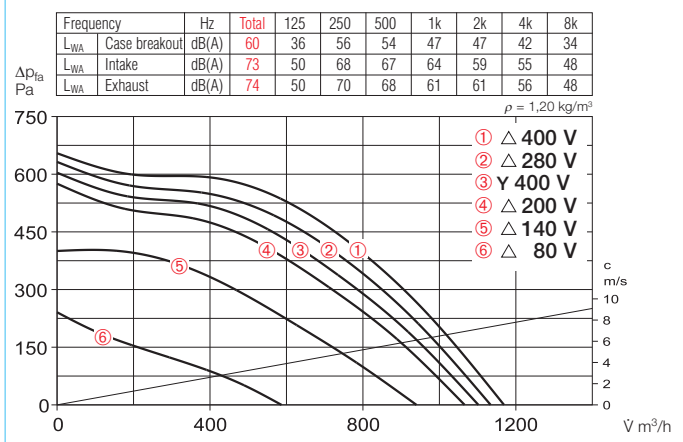

MBD 225/4 Ex

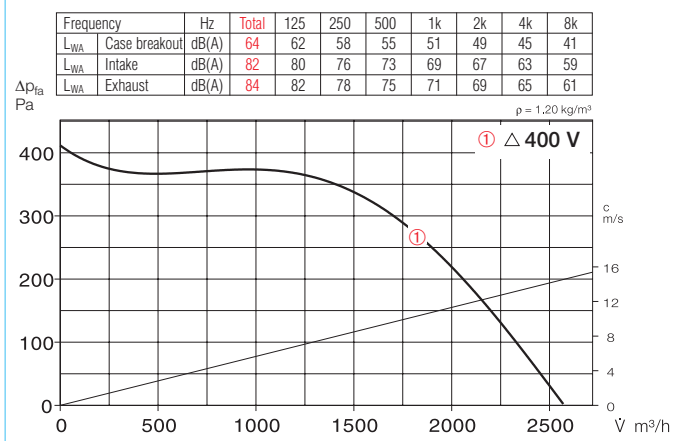

Flexible sleeve for installation between fan and duct system.
FM 200 (+70 °C) No. 1670
FM 200 T120 (+120 °C) No. 1654
FM 250 Ex No. 1688

Speed and on/off switch for two-speed Y/Δ switchable three phase fans.
Type DS 2³⁾ Ref. no. 1351

Type	Ref. no.	Air flow volume max.	R.P.M.	Sound press. case breakout	Motor power*	Current* full load	Current* speed control	Wiring diagram	max. air flow temperature at full load	Weight net approx.	5-step transformer with full motor protect.	speed controller without full motor protect.	Full motor protect. for connection of built-in therma cont.			
		m^3/h	min^{-1}	dB(A) in 1 m	kW	A	A	No.	+°C	+°C	Type	Ref. no.	Type	Ref. no.	Type	Ref. no.
1 ph. motor, 230 V, 50 Hz, capacitor motor, protection to IP 55																
MBW 225/2	6456	1170	2900	52	0.21	1.10	1.80	1119	100	60	MWS 3	1948	TSW 3,0	1496	MW ¹⁾	1579
Two-speed, 3 ph. motor, 400 V, 50 Hz, Y/Δ wiring, protection to IP 55																
MBD 225/2/2	6457	1100/1170	2675/2885	49/52	0.16/0.20	0.29/0.57	0.57	520	100	60	RDS 1	1314	TSD 0,8 ³⁾	1500	M4 ²⁾	1571
Explosion-proof Ex e II, temp. class T1 – T3, 3 ph. motor 400 V, 50 Hz, protection to IP 55																
MBD 225/4 Ex ⁴⁾	6011	2770	1390	56	0.75	2.00	—	470	40	—	40	not permitted	not permitted	—	—	—

* For Ex-types: Motor rated values, see Information p. 16 1) incl. operating switch 2) incl. operating and speed switch 3) necessary full motor protection device: Type MD, No. 5849

4) Dimensional drawing on www.HeliosSelect.de

MB



(Fig. similar)

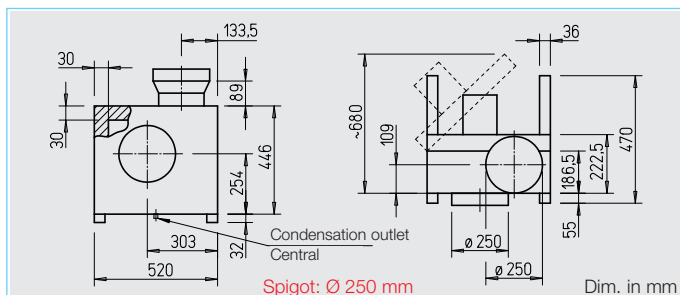

□ Casing

See page 264.

□ Impeller

Backward curved high-performance centrifugal impeller made from aluminium and forward curved made from galvanised steel for ex-proof types. Together with the dynamically balanced motor. High efficiency, low noise, aerodynamically optimised volute casing.

□ Motor

Through maintenance-free IEC flange motor protected to IP 55. Ball bearing mounted, interference-free.

□ Electrical connection

Standard terminal box (IP 55) mounted on running cable and outside of motor for ex-proof types.

□ Motor protection

Motors have thermal contacts wired to the terminal box and must be connected to a motor protection unit.

□ Speed control

See page 264.

■ Accessories

Wall bracket galv. sheet steel.

Type MB-WK EC250 No. 5526

Wall bracket for ex-types

Type MB-WK 250 No. 5527

Rain repellent roof from galv.

sheet steel. Mounted above motor.

Type MB-WSD No. 1856

MBW 250/2

Frequency	Hz	Total	125	250	500	1k	2k	4k	8k
L _{WA} Case breakout	dB(A)	63	36	60	55	50	50	44	36
L _{WA} Intake	dB(A)	76	52	74	69	67	64	59	55
L _{WA} Exhaust	dB(A)	78	51	75	70	65	65	59	51

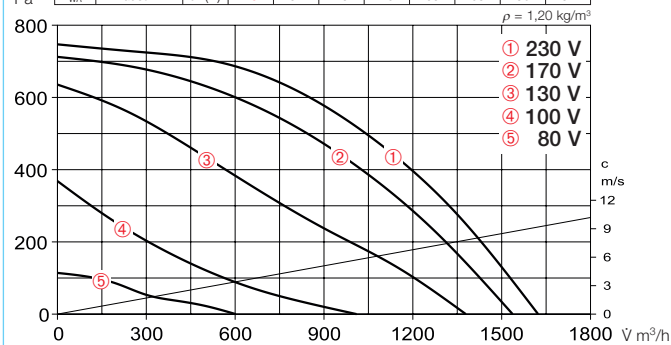

MBD 250/2/2

Frequency	Hz	Total	125	250	500	1k	2k	4k	8k
L _{WA} Case breakout	dB(A)	64	37	60	52	51	50	44	38
L _{WA} Intake	dB(A)	76	51	70	69	66	64	60	56
L _{WA} Exhaust	dB(A)	78	52	75	72	66	65	59	53

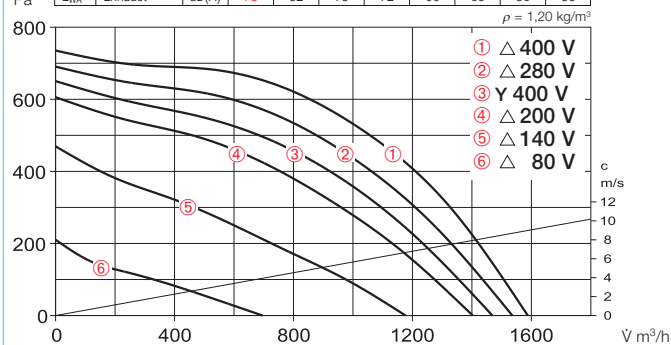

MBD 250/4 Ex

Frequency	Hz	Total	125	250	500	1k	2k	4k	8k
L _{WA} Case breakout	dB(A)	68	66	62	59	55	53	49	45
L _{WA} Intake	dB(A)	86	84	80	77	73	71	67	63
L _{WA} Exhaust	dB(A)	88	86	82	79	75	73	69	65

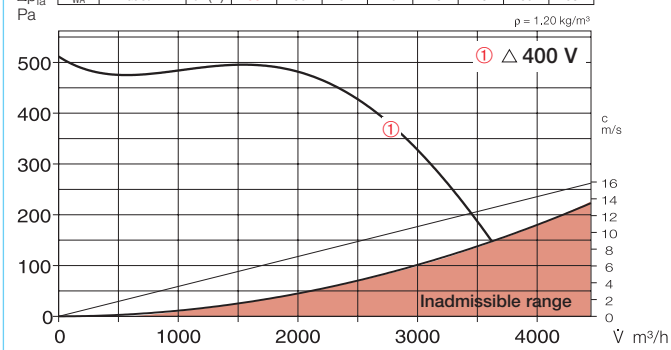

Flexible sleeve for installation between fan and duct system.

FM 250 (+70 °C) No. 1672

FM 250 T120 (+120 °C) No. 1655

FM 315 Ex No. 1690

Speed and on/off switch for two-speed Y/Δ switchable three phase fans.

Type DS 2³⁾ Ref. no. 1351

Type	Ref. no.	Air flow volume max.	R.P.M.	Sound press. case breakout	Motor power*	Current* full load	Current* speed control	Wiring diagram	max. air flow temperature at full load	Weight net approx.	5-step transformer with full motor protect.	speed controller without full motor protect.	Full motor protect. for connection of built-in therma cont.				
		V m³/h	min ⁻¹	dB(A) in 1 m	kW	A	A	No.	+°C	+°C	Type	Ref. no.	Type	Ref. no.	Type	Ref. no.	
1 ph. motor, 230 V, 50 Hz, capacitor motor, protection to IP 55																	
MBW 250/2	6458	1620	2840	55	0,30	1.40	2.10	1119	100	60	28.0	MWS 3	1948	TSW 3,0	1496	MW ¹⁾	1579
Two-speed, 3 ph. motor, 400 V, 50 Hz, Y/Δ wiring, protection to IP 55																	
MBD 250/2/2	6459	1470/1600	2500/2820	53/56	0,23/0,29	0,40/0,70	0,70	520	100	60	28.0	RDS 1	1314	TSD 0,8 ³⁾	1500	M4 ²⁾	1571
Explosion-proof Ex e II, temp. class T1 – T3, 3 ph. motor 400 V, 50 Hz, protection to IP 55																	
MBD 250/4 Ex ⁴⁾	6014	4140	1405	62	1.50	3.35	—	470	40	—	52.0	not permitted	not permitted	—	—	—	—

* For Ex-types: Motor rated values, see Information p. 16

1) incl. operating switch

2) incl. operating and speed switch

3) necessary full motor protection device: Type MD, No. 5849

4) Dimensional drawing on www.HeliosSelect.de

MB



(Fig. similar)

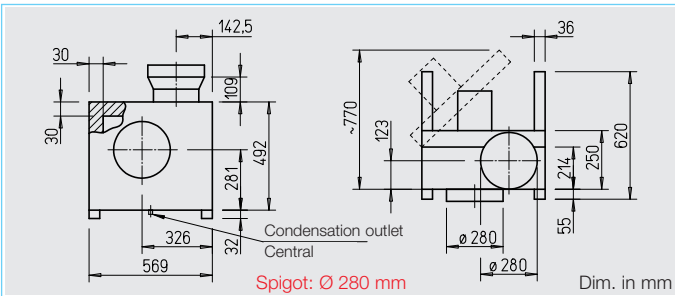

- Casing**
See page 264.
- Impeller**
Forward curved high-performance centrifugal impeller made from aluminium and forward curved made from galvanised steel for ex-proof types. Together with the dynamically balanced motor. High efficiency, low noise, aerodynamically optimised volute casing.
- Motor**
Through maintenance-free IEC flange motor protected to IP 55. Ball bearing mounted, interference-free.
- Electrical connection**
Standard terminal box (IP 55) mounted on running cable and outside of motor for ex-proof types.
- Motor protection**
Motors have thermal contacts wired to the terminal box and must be connected to a motor protection unit.
- Speed control**
See page 264.
- Accessories**
 - Wall bracket galv. sheet steel.**
Type MB-WK EC280 No. 5527
 - Wall bracket for ex-types**
Type MB-WK 280 No. 5527
 - Rain repellent roof from galv. sheet steel.** Mounted above motor.
Type MB-WSD No. 1856

MBD 280/2/2

Frequency	Hz	Total	125	250	500	1k	2k	4k	8k
L _{WA} Case breakout	dB(A)	68	42	46	59	54	52	45	35
L _{WA} Intake	dB(A)	83	59	78	78	73	67	62	58
L _{WA} Exhaust	dB(A)	88	62	86	79	74	72	65	55

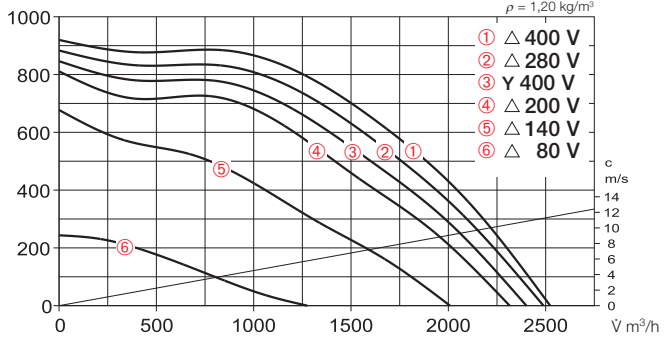

MBD 280/6 Ex

Frequency	Hz	Total	125	250	500	1k	2k	4k	8k
L _{WA} Case breakout	dB(A)	62	60	56	53	49	47	43	39
L _{WA} Intake	dB(A)	80	78	74	71	67	65	61	57
L _{WA} Exhaust	dB(A)	82	80	76	73	69	67	63	59

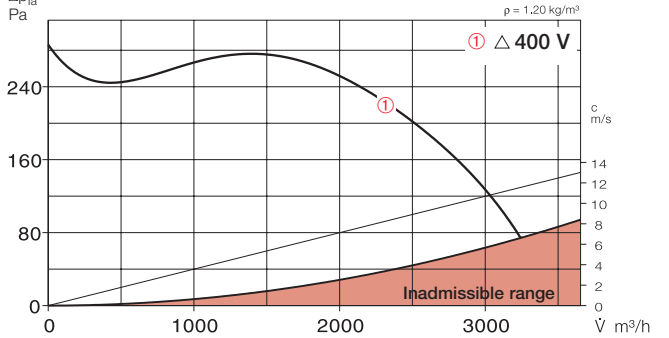

MBD 280/4 Ex

Frequency	Hz	Total	125	250	500	1k	2k	4k	8k
L _{WA} Case breakout	dB(A)	71	69	65	62	58	56	52	48
L _{WA} Intake	dB(A)	89	87	83	80	76	74	70	66
L _{WA} Exhaust	dB(A)	91	89	85	82	78	76	72	68

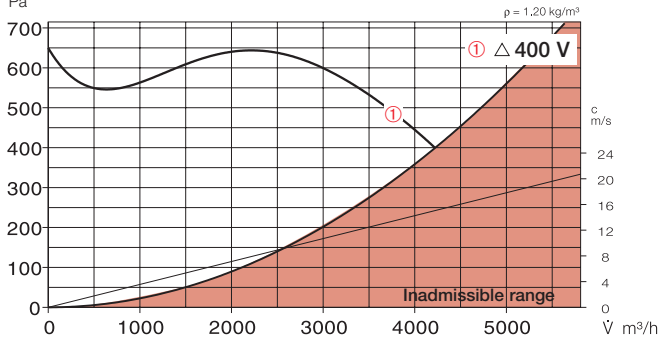

Flexible sleeve for installation between fan and duct system.
FM 280 (+70 °C) No. 1673
FM 280 T120 (+120 °C) No. 1656
FM 315 Ex No. 1690

Speed and on/off switch for two-speed Y/Δ switchable three phase fans.
Type DS 2²⁾ Ref. no. 1351

Type	Ref. no.	Air flow volume max.	R.P.M.	Sound press. case breakout	Motor power*	Current*		Wiring diagram	max. air flow temperature at full load		Weight net approx.	5-step transformer with full motor protect.		speed controller without full motor protect.		Full motor protect. for connection of built-in therma cont.	
						full load	speed control		+°C	+°C		Type	Ref. no.	Type	Ref. no.	Type	Ref. no.
Two-speed, 3 ph. motor, 400 V, 50 Hz, Y/Δ wiring, protection to IP 55																	
MBD 280/2/2	6460	2400/2520	2680/2890	56/60	0.48/0.57	0.80/1.50	1.60	520	100	60	35.0	RDS 2	1315	TSD 3,0²⁾	1502	M4¹⁾	1571
Explosion-proof Ex e II, temp. class T1 – T3, 3 ph. motor 230/400 V, 50 Hz, protection to IP 55																	
MBD 280/6 Ex³⁾	6016	2960	925	56	0.95	2.70	—	498	40	—	60.0	not permitted	not permitted	—	—	—	—
MBD 280/4 Ex³⁾	6017	4960	1420	65	2.00	4.65	—	498	40	—	68.0	not permitted	not permitted	—	—	—	—

* For Ex-types: Motor rated values, see Information p. 16

¹⁾ incl. operating and speed switch

²⁾ necessary full motor protection device: Type MD, No. 5849

³⁾ Dimensional drawing on www.HeliosSelect.de

MB

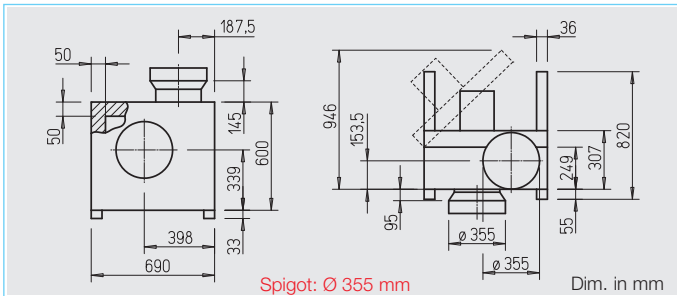

□ Casing

See page 264.

□ Impeller

Backward curved high-performance centrifugal impeller made from aluminium, directly mounted to motor shaft. High efficiency, low noise, aerodynamically optimised volute casing. Dynamically balanced according to DIN ISO 1940 T.1 – grade 6.3.

□ Motor

Through maintenance-free IEC flange motor protected to IP 55. Ball bearing mounted, interference-free.

□ Electrical connection

Standard terminal box (IP 55) mounted on running cable and outside of motor for type MBD 315/2/2.

□ Motor protection

Motors have thermal contacts wired to the terminal box and must be connected to a motor protection unit.

□ Speed control

All types are speed controllable through voltage reduction by means of transformer (accessories).

The 3~ types can also be operated at two speeds through the Y/Δ switch or full motor protection device M4. The performance stages are shown in the characteristic curve.

■ Accessories

Wall bracket galv. sheet steel.

Type MB-WK 315 No. 5528

Rain repellent roof from galv. sheet steel. Mounted above motor.

Type MB-WSD No. 1856

MBW 315/4

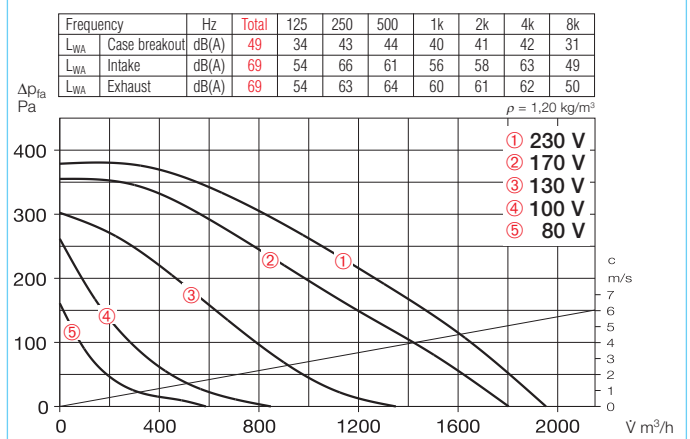

MBD 315/4/4

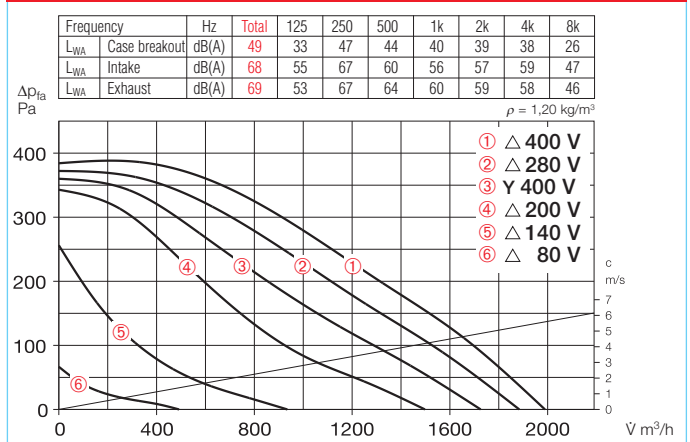

MBD 315/2/2

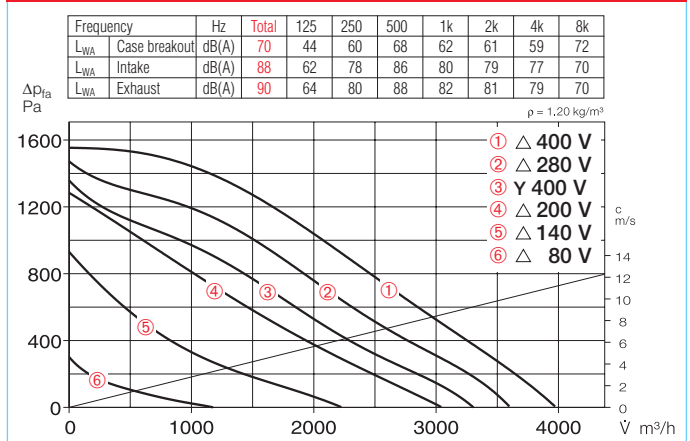

Flexible sleeve for installation between fan and duct system.

FM 355 (+70 °C) No. 1675

FM 355 T120 (+120 °C) No. 1658

Speed and on/off switch for two-speed Y/Δ switchable three phase fans.

Type DS 2³⁾ Ref. no. 1351

Type	Ref. no.	Air flow volume max.	R.P.M.	Sound press. case breakout	Motor power	Current full load	Current speed control	Wiring diagram	max. air flow temperature at full load	Weight net approx.	5-step transformer with full motor protect.	speed controller without full motor protect.	Full motor protect. for connection of built-in therma cont.				
		V m ³ /h	min ⁻¹	dB(A) in 1 m	kW	A	A	No.	+°C	+°C	Type	Ref. no.	Type	Ref. no.	Type	Ref. no.	
1 ph. motor, 230 V, 50 Hz, capacitor motor, protection to IP 55																	
MBW 315/4	5929	1950	1400	41	0.16	0.80	0.97	1119	100	60	72.0	MWS 1,5	1947	TSW 1,5	1495	MW ¹⁾	1579
Two-speed, 3 ph. motor, 400 V, 50 Hz, Y/Δ wiring, protection to IP 55																	
MBD 315/4/4	5945	1730/1990	1180/1430	37/41	0.14/0.16	0.27/0.37	0.46	520	100	60	72.0	RDS 1	1314	TSD 0,8 ³⁾	1500	M4 ²⁾	1571
MBD 315/2/2	5946	3300/3980	2270/2780	60/64	0.86/1.16	1.40/2.20	2.40	520	100	60	75.0	RDS 4	1316	TSD 3,0 ³⁾	1502	M4 ²⁾	1571

1) incl. operating switch

2) incl. operating and speed switch

3) necessary full motor protection device: Type MD, No. 5849

MB

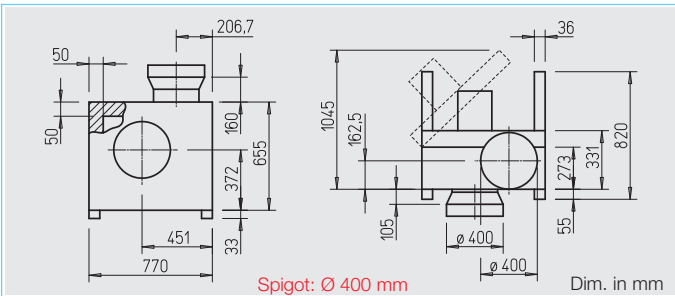

- Casing**
See page 264.
- Impeller**
Forward curved high-performance centrifugal impeller made from aluminium, directly mounted to motor shaft. High efficiency, low noise, aerodynamically optimised volute casing. Dynamically balanced according to DIN ISO 1940 T.1 – grade 6.3.
- Motor**
Through maintenance-free IEC flange motor protected to IP 55. Ball bearing mounted, interference-free.
- Electrical connection**
Standard terminal box (IP 55) mounted on running cable and outside of motor for type MBD 355/2/2.
- Motor protection**
Motors have thermal contacts wired to the terminal box and must be connected to a motor protection unit.
- Speed control**
All types are speed controllable through voltage reduction by means of transformer (accessories).
The 3- types can also be operated at two speeds through the Y/Δ switch or full motor protection device M4. The performance stages are shown in the characteristic curve.
- Accessories**
 - Wall bracket** galv. sheet steel.
Type MB-WK 355 No. 5528
 - Rain repellent roof** from galv. sheet steel, Mounted above motor.
Type MB-WSD No. 1856

MBW 355/4

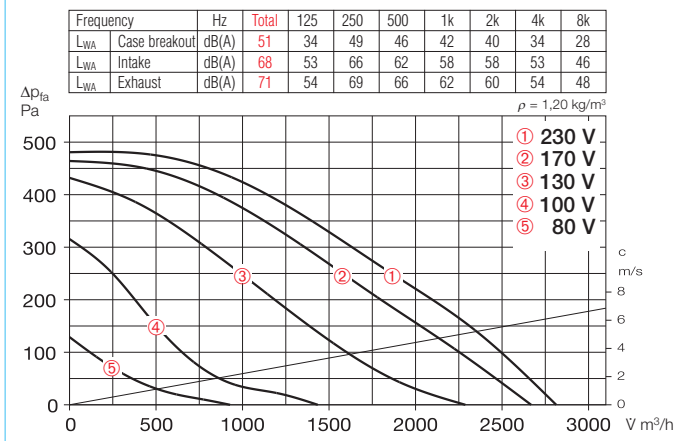

MBD 355/4/4

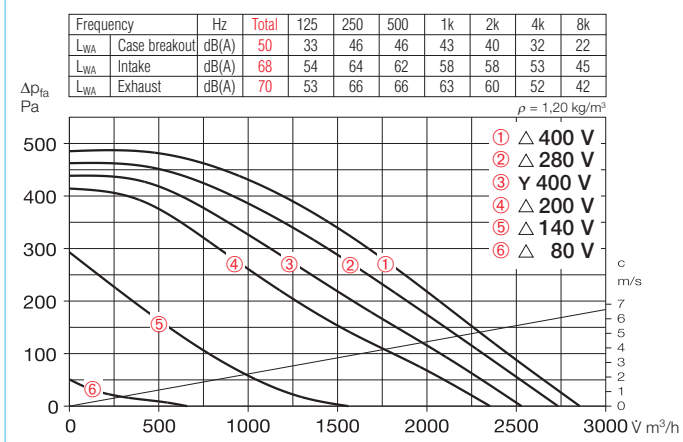

MBD 355/2/2

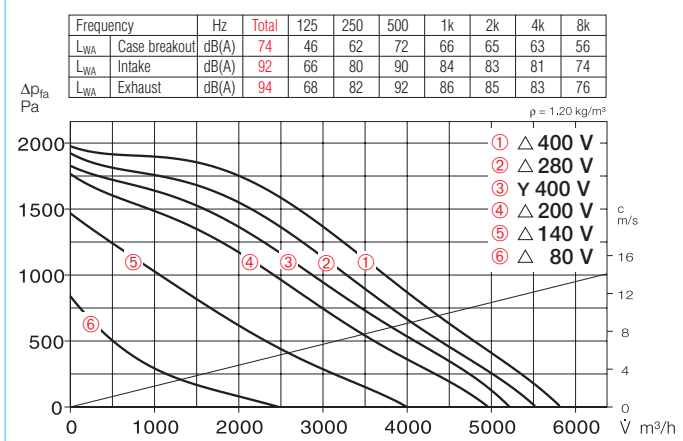

Flexible sleeve for installation between fan and duct system.
FM 400 (+70 °C) No. 1676
FM 400 T120 (+120 °C) No. 1659

Speed and on/off switch for two-speed Y/Δ switchable three phase fans.
Type DS 2³⁾ Ref. no. 1351

Type	Ref. no.	Air flow volume max.	R.P.M.	Sound press. case breakout	Motor power	Current full load	Current speed control	Wiring diagram	max. air flow temperature at full load	Weight net approx.	5-step transformer with full motor protect.	speed controller without full motor protect.	Full motor protect. for connection of built-in therma cont.				
		V m ³ /h	min ⁻¹	dB(A) in 1 m	kW	A	A	No.	+°C	+°C	Type	Ref. no.	Type	Ref. no.	Type	Ref. no.	
1 ph. motor, 230 V, 50 Hz, capacitor motor, protection to IP 55																	
MBW 355/4	5951	2810	1410	43	0.30	1.40	1.90	1119	100	60	81	MWS 3	1948	TSW 3,0	1496	MW ¹⁾	1579
Two-speed, 3 ph. motor, 400 V, 50 Hz, Y/Δ wiring, protection to IP 55																	
MBD 355/4/4	5947	2530/2850	1240/1430	40/42	0.26/0.30	0.45/0.63	0.84	520	100	60	81.0	RDS 2	1315	TSD 1,5 ³⁾	1501	M4 ²⁾	1571
MBD 355/2/2	5948	5210/5800	2840/2510	65/68	2.20/1.65	2.9/5.0	5.50	520	100	60	100.0	RDS 7	1578	TSD 7,0 ³⁾	1504	M4 ²⁾	1571

1) incl. operating switch 2) incl. operating and speed switch 3) necessary full motor protection device: Type MD, No. 5849

MB

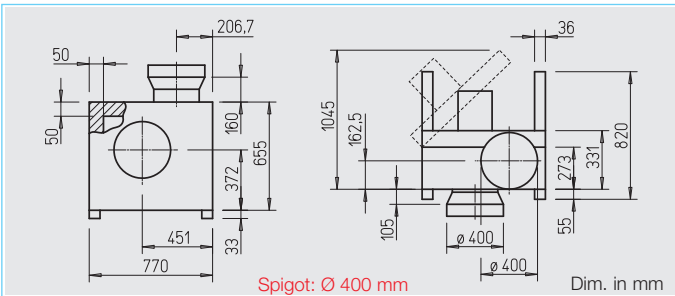

□ Casing

See page 264.

□ Impeller

Forward curved high-performance centrifugal impeller made from aluminium, directly mounted to motor shaft. High efficiency, low noise, aerodynamically optimised volute casing. Dynamically balanced according to DIN ISO 1940 T.1 – grade 6.3.

□ Motor

Through maintenance-free IEC flange motor protected to IP 55. Ball bearing mounted, interference-free.

□ Electrical connection

Standard terminal box (IP 55) mounted on running cable and outside of motor for type MBD 400/2/2.

□ Motor protection

Motors have thermal contacts wired to the terminal box and must be connected to a motor protection unit.

□ Speed control

All types are speed controllable through voltage reduction by means of transformer (accessories).

The 3~ types can also be operated at two speeds through the Y/Δ switch or full motor protection device M4. The performance stages are shown in the characteristic curve.

■ Accessories

Wall bracket galv. sheet steel.

Type MB-WK 400 No. 5528

Rain repellent roof from galv. sheet steel. Mounted above motor.

Type MB-WSD No. 1856

MBW 400/4

Frequency	Hz	Total	125	250	500	1k	2k	4k	8k
L _{WA} Case breakout	dB(A)	56	39	56	50	46	43	44	32
L _{WA} Intake	dB(A)	78	61	77	67	69	66	68	56
L _{WA} Exhaust	dB(A)	76	59	76	70	66	63	64	52

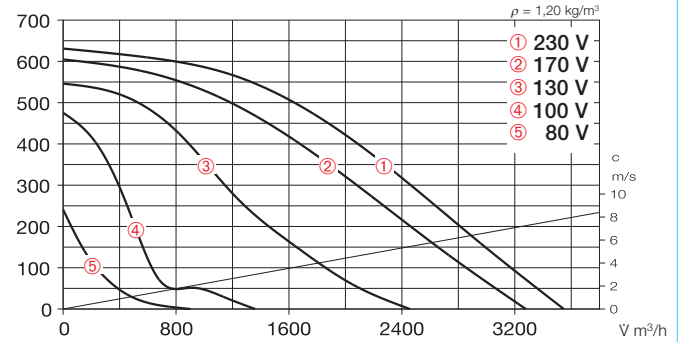

MBD 400/4/4

Frequency	Hz	Total	125	250	500	1k	2k	4k	8k
L _{WA} Case breakout	dB(A)	58	41	57	51	47	46	47	34
L _{WA} Intake	dB(A)	77	60	77	64	64	65	68	55
L _{WA} Exhaust	dB(A)	78	61	77	71	67	66	67	54

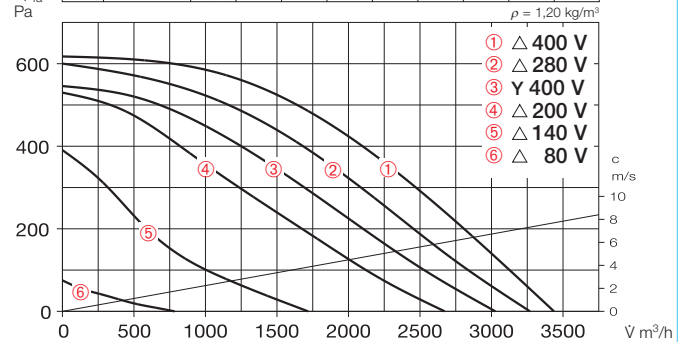

MBD 400/2/2

Frequency	Hz	Total	125	250	500	1k	2k	4k	8k
L _{WA} Case breakout	dB(A)	80	55	69	79	70	70	67	81
L _{WA} Intake	dB(A)	98	73	87	97	88	88	85	79
L _{WA} Exhaust	dB(A)	100	75	89	99	90	90	87	79

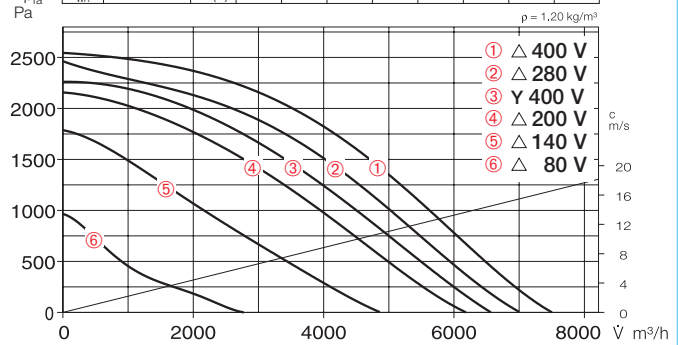

Flexible sleeve for installation between fan and duct system.

FM 400 (+70 °C) No. 1676

FM 400 T120 (+120 °C) No. 1659

Speed and on/off switch for two-speed Y/Δ switchable three phase fans.

Type DS 2³⁾ Ref. no. 1351

Type	Ref. no.	Air flow volume max.	R.P.M.	Sound press. case breakout	Motor power	Current full load	Current speed control	Wiring diagram	max. air flow temperature at full load	Weight net approx.	5-step transformer with full motor protect.	speed controller without full motor protect.	Full motor protect. for connection of built-in therma cont.				
		V m³/h	min ⁻¹	dB(A) in 1 m	kW	A	A	No.	+°C	+°C	Type	Ref. no.	Type	Ref. no.	Type	Ref. no.	
1 ph. motor, 230 V, 50 Hz, capacitor motor, protection to IP 55																	
MBW 400/4	5953	3550	1410	48	0.49	2.50	3.70	1119	100	60	85.0	MWS 7,5	1950	TSW 7,5	1596	MW ¹⁾	1579
Two-speed, 3 ph. motor, 400 V, 50 Hz, Y/Δ wiring, protection to IP 55																	
MBD 400/4/4	5955	3030/3440	1180/1410	46/50	0.41/0.50	0.71/1.00	1.30	520	100	60	82.0	RDS 2	1315	TSD 1,5 ³⁾	1501	M4 ²⁾	1571
MBD 400/2/2	5949	6570/7500	2840/2510	71/74	3.10/3.70	6.10/4.80	9.00	520	100	60	110.0	RDS 11	1332	TSD 11 ³⁾	1513	M4 ²⁾	1571

1) incl. operating switch

2) incl. operating and speed switch

3) necessary full motor protection device: Type MD, No. 5849

Comfortable climate with pre-heated, filtered supply air.



Ingeniously practical:

Supply air, heating and filter in a single unit. For direct in-duct mounting.

The fresh air boxes ALB from Helios ensure a pleasant room climate due to the inflow of outside air, which is filtered and heated to the specified temperature.

ALB are ideally suited to all rooms in which clean, pre-heated fresh air is required. Whether in bistros, boutiques or other commercial areas.

Specially equipped attenuator casing and low-noise centrifugal fans ensure that the fresh air boxes are virtually silent.

Large surface pocket filters ensure that cleaning intervals are as long as possible.

Control options for great levels of comfort and efficient energy-saving are included in the delivery or available as accessories.

EH MODEL WITH ELECTRIC HEATING

ALB EH

With electric heating and air filter. Stepless control of heating output.

Ø 125 and 200 mm.

286^{on}

WW MODEL WITH WARM WATER HEATING

ALB WW

With warm water heating and air filter. Delivered ready-for-connection, including control unit and room filter.

Ø 220 and 280 mm. 50 x 30 cm and 60 x 35 cm.

290^{on}

■ The Helios fresh air boxes ALB are designed for direct in-duct mounting and ensure controlled supply of filtered and pre-heated outside air in restaurants, bistros, office rooms, etc. $V = 350 \text{ m}^3/\text{h}$ to $5000 \text{ m}^3/\text{h}$. Available options:

- **ALB EH**
with electric heating and air filter.
- **ALB WW**
with warm water heating and air filter.

■ Delivery

Delivered ready for connection, i.e. the air-conditioning with filter and heater battery is integrated in the compact units in addition to the fan unit.

■ Planning

The complete set significantly simplifies the planning stage. Planning is reduced to simply five steps:

- ① Decide on the required amount of supply air for the rooms.
- ② Decide on the dimensions and position of the supply duct (resistance).
- ③ Decide on the heat required comparing the temperature of the outside air and the indoor temperature (using diagrams on the product pages).
- ④ Choose the suitable ALB size according to points 1, 2 and 3.
- ⑤ Select the control functions and the accessories.

■ Application

- Outside air and supply air boxes can be used everywhere where controlled and filtered supply air that is pre-heated to the specified temperature is required.
- Reduces draughts in living areas.
- For ensuring the necessary air exchange through an appropriate balance between supply air and extract air in rooms.
- For temperature conditioning and heating rooms.
- Fulfilment of hygienic requirements for room air in bistros, offices and meeting rooms as well as equivalent living rooms according to VDI 6022.
- For single-stage filtration, filter class F7 and filter monitoring (using differential pressure switch type DDS, accessories) must always be provided pursuant to VDI 6022.
- Targeted, controlled and low-noise inflow of outside air into the desired areas. If necessary, an attenuator (accessories) must be provided.

■ Installation

- Can be installed in almost any position (see installation and operating instructions).
- If necessary, an attenuator must be provided in the ducting system (accessories).
- Backdraught shutters or motorised shutters must be installed in the ducting to prevent undesired backflow of air.
- We recommend using anti-vibration mounts when securing the unit.
- The controller should be fitted within the ventilated space.
- Easy access to the unit should be provided for cleaning according to DIN EN 13779 and VDI 6022.

■ Control options

- Easy to control, the ALB offers the highest comfort and efficient energy-saving operation.
- Thus, the types ALB EH are delivered with a stepless electronic heater controller as standard, which is controlled via the operating switch B-ALB (accessories) (see Fig. 1). The electronic pulser steplessly controls the heat output by continuously adjusting between the specification and the temperature measured by the room or duct sensor (types TFR-ALB and TFK, accessories).
- Types ALB WW are delivered as standard with an external control unit (see Fig. 2). There is constant adjustment between the specification and the temperature measured by the room sensor (delivered as standard). Furthermore, the control unit also offers inputs for the connection of a humidity or air quality sensor, so that if the values fall below a given limit value, an optical or audible alarm signal occurs.
- The control unit ALB-AS (accessories) can be used to control one or more extract air fans in relation to the speed of fresh air boxes ALB. This allows the synchronised operation of the unit as required (supply and extract air) with five speed stages. The control unit also offers inputs for a duct sensor (delivered as standard), as well as a connection for a humidity or air quality sensor.

Fig. 1: Functional overview ALB EH with electric heating

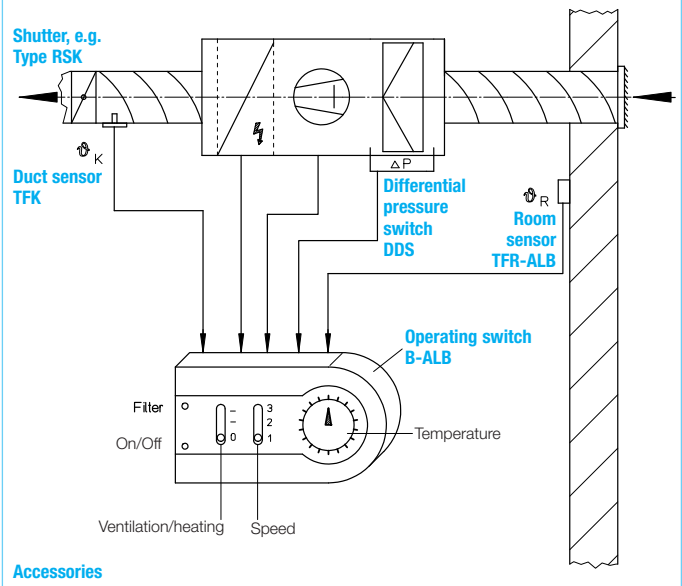

Accessories

Fig. 2: Functional overview ALB WW with warm water heating

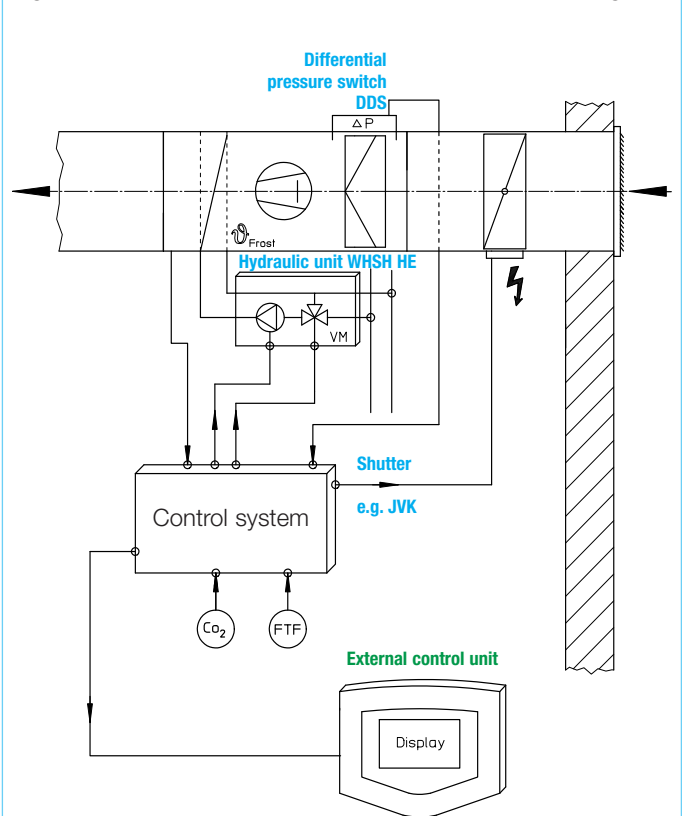

Delivered as standard

Accessories

To be provided on-site

■ Figure 1 ALB-EH

- Accessories:
 - Operating switch B-ALB
 - Backdraught shutter RSK
 - Differential pressure switch DDS
 - Room sensor TFR-ALB
 - Duct sensor TFK
 - Attenuator, e.g. FSD

■ Figure 2 ALB-WW

- Delivery includes:
 - External control unit with integrated room sensor and week timer.
- Accessories:
 - Hydraulic unit WSH HE
 - Differential pressure switch DDS
 - Shutter, e.g. JVK
 - Attenuator, e.g. KSD
 - Adaptor ALB-ÜS
 - Air quality sensor KWL-CO₂
 - Humidity sensor KWL-FTF

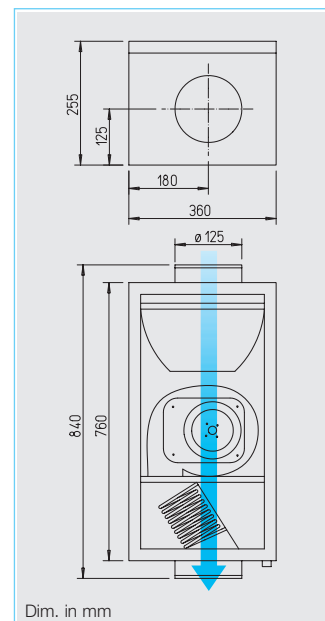

■ **Application / Function**
Pleasant room climate through the inflow of outside air, which is filtered and automatically heated to the specified temperature. This is provided by the fresh air boxes from Helios.

Specially designed for direct in-duct mounting.
For various applications in the commercial sector.

■ **Specification**
Compact shallow casing, thermally and acoustically insulated, with an integral air filter, fan, heater with controller and terminal box. Delivered ready for installation.
Delivered as standard with an electronic stepless heating controller. Operation switch B-ALB is required for remote control, which allows for three-step ventilation and connection to a room or duct temperature sensor to control the specified set-point temperature. These elements need to be ordered separately (see accessories).

□ **Casing**
Made from galvanised sheet steel, with 50 mm mineral wool cladding on all sides, which is also clad with dirt-repellent fibre glass. The casing cover is easy to remove using the four spring fasteners.
Intake and extract duct spigots with air tight rubber gaskets for standard duct Ø.

□ **Filter**
The large surface pocket filter for long cleaning intervals is by removing the casing cover.
Standard version in class G4. Higher classification filters in M5 and F7 (see accessories) are available as alternatives. The reduction of the volume flow (see performance curve) must be considered.
Periodic filter control / cleaning is required.

Automatic monitoring with DDS (accessory) is recommended; the ALB casing has the corresponding fixing holes.

□ **Fan**
The air flow volume can be switched in three stages with the operating switch.
A silent and powerful centrifugal fan, installed within a spiral casing made from galvanised sheet steel. Motor/impeller unit swings out for access and freely accessible. Powered by a maintenance-free external rotor motor. Protection class IP 44.

□ **Heater battery**
Enclosed heater elements made from stainless steel with low surface temperature heat the outside air to the specified setpoint temperature. The electronic pulser steplessly controls the heating output in steady balance between the specification and the temperature measured by the room or duct sensor.

□ **Safety switch**
The heater battery can only be operated if the fan is on and there is a minimum air flow. If the air-flow falls below this limit, a thermostat disconnects the heater from the power supply as soon as the temperature rises to 80 °C.
Additionally, two independent thermostats can be reset manually if the heater is stopped when the heater temperature rises to 120 °C.

□ **Overrun timer**
The ALB comes with an overrun timer of approx. 1 minute, even if the heater is not in operation.

□ **Electrical connection**
A large terminal box in the casing.
Cable entry points at the front through four cable glands.

□ **Motor protection**
Motor protection by thermal contacts wired in series with the motor windings. The main supply must be switched off and on again to reset the thermal contacts.

■ **Sound levels**
Total sound power levels and the spectrum figures in db(A) are given for:
– Sound level case breakout
– Sound level intake / extract
The table below also contains the sound pressure levels at 1 m (free field conditions).
If necessary, cross talk attenuators are available (accessory) for further acoustic reduction.

Type	Ref. no.	Connection Ø	Air flow volume* free discharge	Max. R.P.M.	Sound pressure level		Voltage 50 Hz	Power consumption		Current max. total	Wiring diagram	Maximum supply air temp. for operation		Weight net approx.
					case breakout	supply air noise		Motor	Heating			with heating	w/o heating	
		mm	∇ m³/h (max.)	min ⁻¹	dB(A) at 1 m	dB(A) at 1 m	Volt	kW	kW	A	No.	+°C	+°C	kg
ALB 125 C EH 2	2701	125	340	1850	42	57	230, 1~	0.110	2	9.2	795.4	20	40	20

* with standard filter, class G 4

ALB 125 C EH 2

Frequency		Hz	Total	125	250	500	1k	2k	4k	8k
L _{WA}	Case breakout	dB(A)	48	38	44	45	39	36	32	32
L _{WA}	Extract	dB(A)	65	60	56	56	58	57	49	45
L _{WA}	Intake	dB(A)	54	43	51	43	42	43	42	32

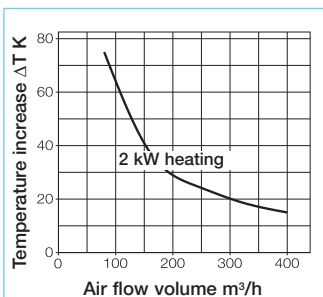
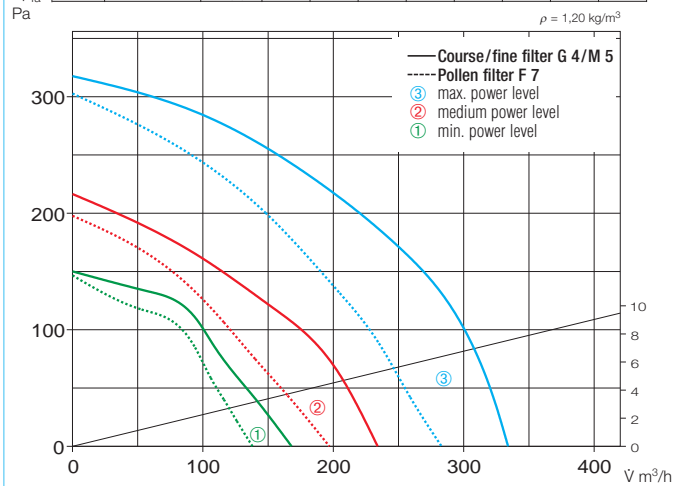

Note

The integration of air filter ELF-ALB 125 F7 (see right) and differential pressure switch DDS (Ref. no. 0445) in fresh air systems fulfills the requirements of VDI 6022.

Information	Page	Other accessories	Page
Techn. description	285	Attenuators	434
Information for planning	10 on	Flexible ducting, grilles, moulded parts, electr. shutters,	
		Roof outlets	487 on
		Supply air valves	510

Accessories

Operating switch

Type B-ALB Ref. no. 2734

With functions:

- Ventilation operation 3-step and on/off.
- Heater battery with adjustable temperature when sensors are connected.
- Overrun operation of the fan.
- Filter monitoring (accessory DDS)
- Operating display (LED).

Protection class IP 30
 Wiring diagram no. 795.3
 Dim. mm W 145 x H 80 x D 30



Room sensor

Type TFR-ALB Ref. no. 2761

Room temperature sensor surface mounted for connection to operation switch B-ALB. Made of polymer.

Temperature range 0 – 30 °C
 Protection class IP 20
 Dim. mm W 86 x H 86 x D 30
 Weight approx. 0.1 kg



Duct sensor

Type TFK Ref. no. 5005

Temperature sensor to be installed within the duct for connection to operation switch B-ALB.

Temperature range 0 – 30 °C
 Protection class IP 20
 Length inner/outer 130/50 mm, Ø 10 mm
 Weight approx. 0.1 kg



Spare and pollen filters

ELF-ALB 125 G4 Ref. no. 2704

ELF-ALB 125 M5 Ref. no. 2705

ELF-ALB 125 F7 Ref. no. 2706

Large surface pocket filter for long cleaning intervals.
 Contents = 3 pcs.



Differential pressure switch

Type DDS Ref. no. 0445

Adjustable opener/closer for monitoring pressure loss.



Extract air control

Type ALB-AS 125 Ref. no. 2696

A control unit for the regulation of an extract air fan (max. 1.5 A) at the same rate as the speed of the supply air fan. Allows synchronised operation of the unit (supply and extract air) with three (from 5 selectable) speed steps (factory setting 80, 130, 230 V). The control unit is connected with the supply system through a cable, the setting takes place directly at the operating switch B-ALB (accessories, Ref. no. 2734). ALB-AS allows the connection of one or many speed controllable fans up to nominal load. An extract and supply air shutter can also be operated, which open when the fan is switched on.



Technical data

Voltage	230 V 1~, 50 Hz 400 V 2~, 50 Hz
Current max.	13.3 A
Protection class	IP 54
Dim. mm	W 236 x H 316 x D 128
Weight approx.	4.3 kg
Wiring diagram no.	900

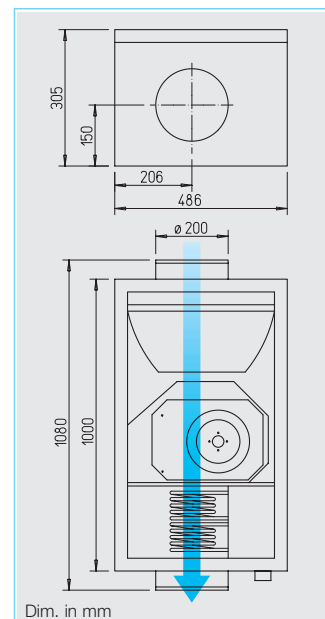

■ **Application / Function**
Pleasant room climate through the inflow of outside air, which is filtered and automatically heated to the specified temperature. This is provided by the fresh air boxes from Helios.

Specially designed for direct in-duct mounting.
For various applications in the commercial sector.

■ **Specification**
Compact shallow casing, thermally and acoustically insulated, with an integral air filter, fan, heater with controller and terminal box. Delivered ready for installation.
Delivered as standard with an electronic stepless heating controller. Operation switch B-ALB is required for remote control, which allows for three-step ventilation and connection to a room or duct temperature sensor to control the specified setpoint temperature. These elements need to be ordered separately (see accessories).

□ **Casing**
Made from galvanised sheet steel, with 50 mm mineral wool cladding on all sides, which is also clad with dirt-repellent fibre glass. The casing cover is easy to remove using the four spring fasteners.
Intake and extract duct spigots with air tight rubber gaskets for standard duct Ø.

□ **Filter**
The large surface pocket filter for long cleaning intervals is freely accessible by removing the casing cover. Standard version in class G4. Higher classification filters in M5 and F7 (see accessories) are available as alternatives. The reduction of the volume flow (see performance curve) must be considered.

Periodic filter control / cleaning is required.
Automatic monitoring with DDS (accessory) is recommended; the ALB casing has the corresponding fixing holes.

□ **Fan**
The air flow volume can be switched in three stages with the operating switch.
A silent and powerful centrifugal fan, installed within a spiral casing made from galvanised sheet steel. Motor/impeller unit swings out for access and freely accessible. Powered by a maintenance-free external rotor motor. Protection class IP 44.

□ **Heater battery**
Enclosed heater elements made from stainless steel with low surface temperature heat the outside air to the specified setpoint temperature. The electronic pulser steplessly controls the heating output in steady balance between the specification and the temperature measured by the room or duct sensor.

□ **Safety switch**
The heater battery can only be operated if the fan is on and there is a minimum air flow. If the air-flow falls below this limit, a thermostat disconnects the heater from the power supply as soon as the temperature rises to 80 °C. Additionally, two independent thermostats can be

reset manually if the heater is stopped when the heater temperature rises to 120 °C.

□ **Overrun timer**
The ALB comes with an overrun timer of approx. 1 minute after the disconnection of the unit, even if the heater is not in operation.

□ **Electrical connection**
A large terminal box in the casing.
Cable entry points at the front through four cable glands.

□ **Motor protection**
Motor protection by thermal contacts wired in series with the motor windings. The main supply must be switched off and on again to reset the thermal contacts.

■ **Sound levels**
Total sound power levels and the spectrum figures in db(A) are given for:
– Sound level case breakout
– Sound level intake / extract
The table below also contains the sound pressure levels at 1 m (free field conditions). If necessary, cross talk attenuators are available (accessory) for further acoustic reduction.

Type	Ref. no.	Connection Ø	Air flow volume* free discharge	Max. R.P.M.	Sound pressure level		Voltage 50 Hz	Power consumption		Current max. total	Wiring diagram	Maximum supply air temp. for operation		Weight net approx.
					case breakout	supply air noise		Motor	Heating			with heating	w/o heating	
		mm	ṽ m³/h (max.)	min ⁻¹	dB(A) at 1 m	dB(A) at 1 m	Volt	kW	kW	A	No.	+°C	+°C	kg
ALB 200 B EH 5	2702	200	650	2500	45	59	400, 2 N-	0.105	4,4	11.6	795.4	20	40	33
ALB 200 C EH 5	2703	200	770	2740	46	63	400, 2 N-	0.150	4,4	11.7	795.4	20	40	32

* with standard filter, class G 4

ALB 200 B EH 5

Frequency		Hz	Total	125	250	500	1k	2k	4k	8k
L _{WA}	Case breakout	dB(A)	51	38	43	49	42	39	34	31
L _{WA}	Extract	dB(A)	67	47	57	65	60	57	54	44
L _{WA}	Intake	dB(A)	53	44	48	50	42	39	35	28

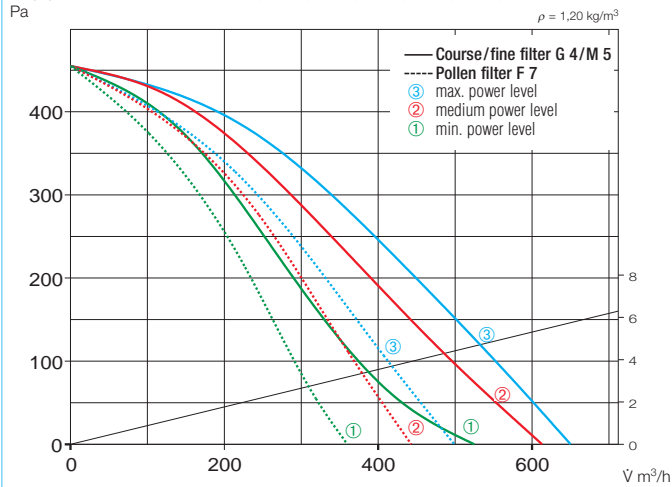

ALB 200 C EH 5

Frequency		Hz	Total	125	250	500	1k	2k	4k	8k
L _{WA}	Case breakout	dB(A)	52	40	51	45	38	34	31	28
L _{WA}	Extract	dB(A)	71	59	65	66	62	61	61	52
L _{WA}	Intake	dB(A)	62	58	57	52	42	40	43	31

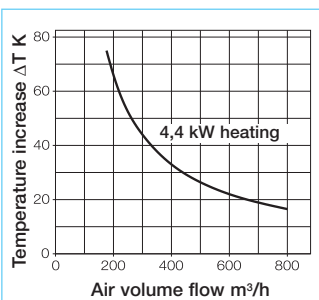
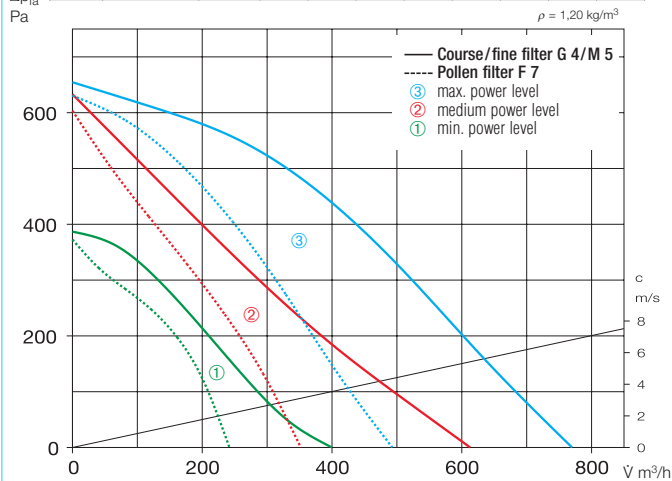

Note

The integration of air filter ELF-ALB 200 F7 (see right) and differential pressure switch DDS (Ref. no. 0445) in fresh air systems fulfills the requirements of VDI 6022.

Information	Page
Techn. description	285
Information for planning	10 on

Other accessories	Page
Attenuators	434
Flexible ducting, grilles, moulded parts, electr. shutters, Roof outlets	487 on
Supply air valves	510

Accessories

Operating switch

Type B-ALB Ref. no. 2734

With functions:

- Ventilation operation 3-step and on/off.
- Heater battery with adjustable temperature when sensors are connected.
- Overrun operation of the fan.
- Filter monitoring (accessory DDS)
- Operating display (LED).

Protection class IP 30
Wiring diagram no. 795.3
Dim. mm W 145 x H 80 x D 30



Room sensor

Type TFR-ALB Ref. no. 2761

Room temperature sensor surface mounted for connection to operation switch B-ALB. Made of polymer.

Temperature range 0 – 30 °C
Protection class IP 20
Dim. mm W 86 x H 86 x D 30
Weight approx. 0.1 kg



Duct sensor

Type TFK Ref. no. 5005

Temperature sensor to be installed within the duct for connection to operation switch B-ALB.

Temperature range 0 – 30 °C
Protection class IP 20
Length inner/outer 130/50 mm, Ø 10 mm
Weight approx. 0.1 kg



Spare and pollen filters

ELF-ALB 200 G4 Ref. no. 2707

ELF-ALB 200 M5 Ref. no. 2708

ELF-ALB 200 F7 Ref. no. 2709

Large surface pocket filter for long cleaning intervals. Contents = 3 pcs.



Differential pressure switch

Type DDS Ref. no. 0445

Adjustable opener/closer for monitoring pressure loss.



Extract air control

Type ALB-AS 200 Ref. no. 2696

A control unit for the regulation of an extract air fan (max. 1.5 A) at the same rate as the speed of the supply air fan. Allows synchronised operation of the unit (supply and extract air) with three (from 5 selectable) speed steps (factory setting 80, 130, 230 V). The control unit is connected with the supply system through a cable, the setting takes place directly at the operating switch B-ALB (accessories, Ref. no. 2734). ALB-AS allows the connection of one or many speed controllable fans up to nominal load. An extract and supply air shutter can also be operated, which open when the fan is switched on.



Technical data

Voltage	230 V 1-, 50 Hz 400 V 2-, 50 Hz
Current max.	13.3 A
Protection class	IP 54
Dim. mm	W 236 x H 316 x D 128
Weight approx.	4.3 kg
Wiring diagram no.	900

ALB WW



Application / Function
Pleasant room climate through the inflow of outside air, which is filtered and automatically heated to the specified temperature. This is provided by the fresh air boxes from Helios.

Operational unit for connection to ducting systems. For various commercial applications.

Specification / Delivery
Compact shallow casing, thermally and acoustically insulated, with an integral air filter, fan and warm water heater. Delivered ready for connection with an external control box for operation of the unit, including a 10 metre long connection cable and integrated room sensor or week timer.

The air quality sensor or humidity sensor (see accessories) can be connected to the electronic system in the terminal box to control the specified setpoint temperature.

Casing
Robust construction made from coated sheet steel, double-walled and filled with 30 mm thick mineral wool cladding on all sides. The hinged casing cover is easy to open for cleaning purposes using the screw connections. Intake and extract duct spigots with air tight rubber gaskets for standard duct diameters. No thermal bridge, smooth surface for easy cleaning. Integrated mounting panel with anti-vibration dampers.

Filter
The large surface pocket filter for long cleaning intervals is freely accessible by removing the casing cover. Standard version in class G4. Higher classification filters in M5 and F7 (see accessories) are available as alternatives. The reduction of air

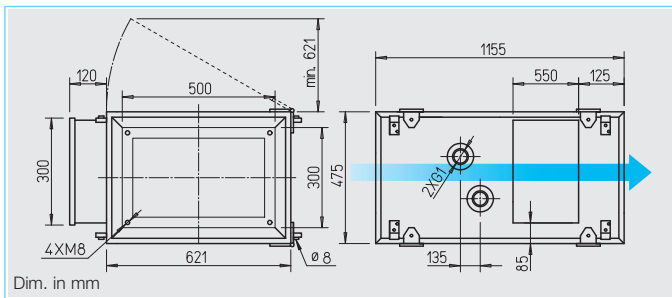

volume flow (see performance curve) must be considered. Periodic filter control / cleaning is required. Automatic monitoring with DDS (accessory) is recommended; the ALB casing has the corresponding fixing holes. The filters correspond to VDI 6022, DIN EN 779.

Fan
The air flow volume can be switched in five stages with the operating switch. A silent and powerful centrifugal fan, installed within a spiral casing made from galvanised sheet steel. Motor/impeller unit swings out for access and freely accessible. Powered by a maintenance-free ball bearing motor which is lubricated for life.

Heater battery
Air heater with AL fins and staggered copper ducting heats the outside air to the specified setpoint temperature. Controlled by connecting a hydraulic unit (accessories) via the integrated

control board. There is a continuous adjustment between the specification and the temperature measured by the room or duct sensor (ALB-ASW included in delivery). A frost protection control is integrated as standard. Max. operating pressure 1.6 MPa. Water connection pipe with male thread.

Electrical connection
Large terminal box protected to IP 20 on outside of casing.

Motor protection
Through thermal contact wired in series with the motor windings. Once the unit has cooled down, automatic reconnection takes place.

Sound levels
The table below also contains the sound pressure levels at 1 m (free field conditions). If necessary, cross talk attenuators are available (accessory) for further acoustic reduction.

Information	Page
Techn. description	285
Information for planning	10 on

- Control**
The remote control is included in delivery and offers:
- 5-step operation.
 - Temperature control with connection from room and/or duct temperature sensor (included in delivery).
 - Anti-freeze protection.
 - Control of the hydraulic unit (accessory) for regulation of the WW-heater battery. Specification of min./max. temperature.
 - Operation of the extract air control ALB-ASW (accessories) for speed control of the extract fans.
 - Indication of surrounding temperature, fan speed and filter contamination (via differential pressure switch, accessory).
- Further inputs and outputs:**
- Automatic control of operation by means of week timer.
 - Fault cause reporting, alarm.
 - Input for air quality or humidity sensor.
 - Output for e.g. damper control.



Type	Ref. no.	Air flow volume* free discharge	Max. R.P.M.	Sound pressure level case breakout supply air noise		Voltage 50 Hz	Power consumption		Current max. total	Wiring diagram	Maximum supply air temp. for operation		Weight net approx.
		∇ m³/h (max.)	min ⁻¹	dB(A) at 1 m	dB(A) at 1 m		Motor	Heating			with heating	w/o heating	
ALB 220/4/50/30 WW	6500	3200	1460	53	71	230, 1~	1.3	—	6.10	1121	20	40	80

* with standard filter, class G 4

ALB 220/4/50/30 WW

Frequency	Hz	Total	125	250	500	1k	2k	4k	8k
L _{WA} Case breakout	dB(A)	61	56	53	52	53	50	50	38
L _{WA} Extract	dB(A)	79	67	63	63	71	71	75	74
L _{WA} Intake	dB(A)	76	64	66	62	65	68	69	66

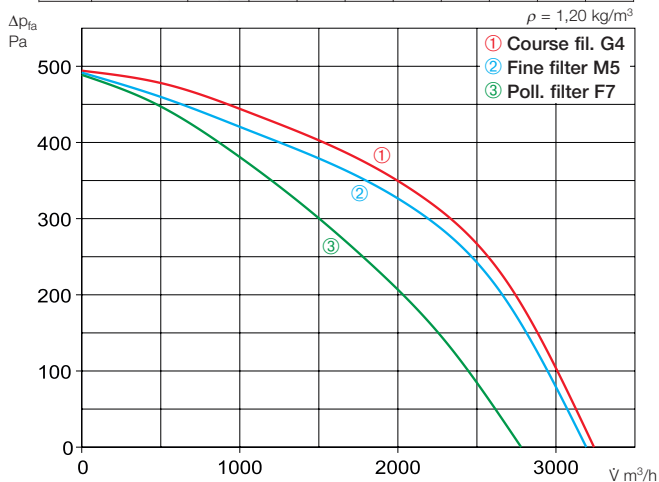

Other accessories	Page	Room sensors	Page
Attenuator	434	Co ₂ and humidity sensor	87 on
Details Hydraulic unit	432		
Flexible ducting, grilles, moulded parts shutters	487 on	Duct sensor for measuring the Co ₂ concentration or room air humidity in air ducts	upon request
Supply air valves	510		

Heat output WW heater ①-③

Diagrams ①-③ show the heat output in relation to the flow/return and outdoor temperature over air flow volume.

Water quantity WW heater ④

④ shows the water flow in relation to the flow/return and outdoor temperature over air flow volume.

Pressure loss WW heater ⑤

⑤ shows the water pressure loss over the water flow.

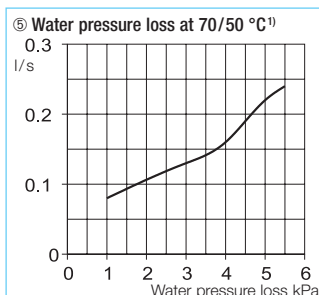
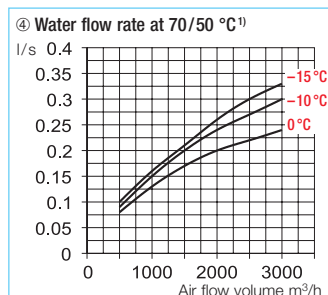
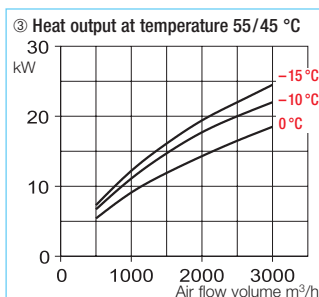
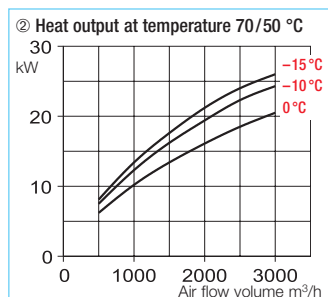
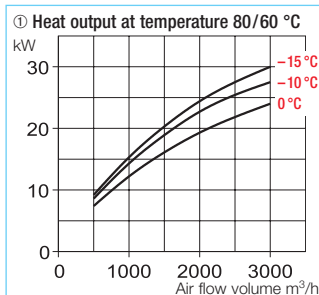

¹⁾ Correction factor for 80/50 °C: 1.16; for 55/45 °C: 1.81

Accessories

Hydraulic unit

WHSH HE 24 V (0-10 V) No. 8318

For regulation of the heat output of the water heater battery in connection with room/ duct sensor. Including flow/ return temperature display, pump, servo motor, mixing valve, ball valve with integrated non-return valve, thermal casing and flexible connection hose.



Spare and pollen filters

Large surface pocket or cassette filters for long cleaning intervals, VDI 6022, DIN EN 779 compliant. Contents = 3 pcs.

ELF-ALB 220/4/50/30 G4 No. 3646

- Filter class G4

ELF-ALB 220/4/50/30 M5 No. 3647

- Filter class M5

ELF-ALB 220/4/50/30 F7 No. 3648

- Filter class F7



Differential pressure switch

Type DDS Ref. no. 0445

Adjustable opener/closer for monitoring pressure loss.



Connection cable (extra long)

- 30 metres long

Type ALB-SK 30 Ref. no. 2517

- 50 metres long

Type ALB-SK 50 Ref. no. 2518

Connection between ALB and remote control and between ALB and ALB-ASW.

Adaptor - symmetrical

From device flange to circular ducting.

ALB-US 220/4/50/30 No. 7515

Flexible sleeve

For acoustic decoupling, incl. 2 hose clamps.

Type FM 315 Ref. no. 1674

Coupling flange ring made from galvanised sheet steel for connection to ducting.

Type FR 315 Ref. no. 1204

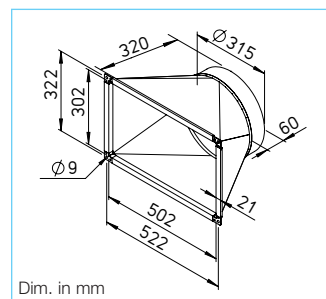

Extract air control

ALB-ASW 220/4/50/30 No. 3655

Control unit incl. duct temperature sensor for regulating an extract air fan in relation to the speed of the supply air fan.

Allows synchronised operation of the unit (supply and extract air) at five speed steps.

The control unit is connected with the supply systems by a control cable. The programming takes place in a few steps directly to the ALB-remote control

ALB-ASW is mountable in any position and allows the connection of one or many speed controllable 1 ph. fans up to nominal load.

Technical data

Voltage	230 V 1~, 50 Hz
Current max.	4 A
Protection class	IP 55
Dim. mm	B 390 x H 470 x T 135
Weight approx.	8.0 kg
Wiring diagram no.	1125



ALB WW



Application / Function
Pleasant room climate through the inflow of outside air, which is filtered and automatically heated to the specified temperature. This is provided by the fresh air boxes from Helios.

Operational unit for connection to ducting systems.
For various commercial applications.

Specification / Delivery
Compact shallow casing, thermally and acoustically insulated, with an integral air filter, fan and warm water heater. Delivered ready for connection with an external control box for operation of the unit, including a 10 metre long connection cable and integrated room sensor or week timer.

The air quality sensor or humidity sensor (see accessories) can be connected to the electronic system in the terminal box to control the specified setpoint temperature.

Casing
Robust construction made from coated sheet steel, double-walled and filled with 30 mm thick mineral wool cladding on all sides. The hinged casing cover is easy to open for cleaning purposes using the screw connections.
Intake and extract duct spigots with air tight rubber gaskets for standard duct diameters.
No thermal bridge, smooth surface for easy cleaning.
Integrated mounting panel with anti-vibration dampers.

Filter
The large surface pocket filter for long cleaning intervals is freely accessible by removing the casing cover. Standard version in class G4. Higher classification filters in M5 and F7 (see accessories) are available as alternatives. The reduction of air

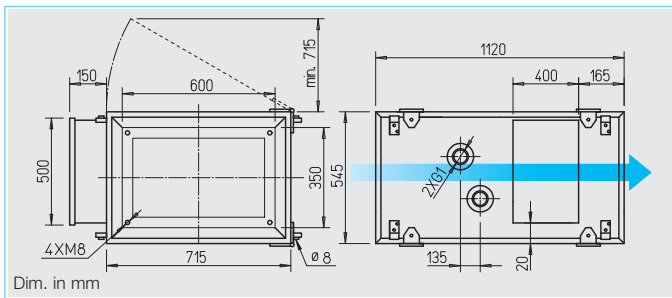

volume flow (see performance curve) must be considered. Periodic filter control / cleaning is required.
Automatic monitoring with DDS (accessory) is recommended; the ALB casing has the corresponding fixing holes. The filters correspond to VDI 6022, DIN EN 779.

Fan
The air flow volume can be switched in five stages with the operating switch.
A silent and powerful centrifugal fan, installed within a spiral casing made from galvanised sheet steel. Motor/impeller unit swings out for access and freely accessible. Powered by a maintenance-free ball bearing motor which is lubricated for life.

Heater battery
Air heater with AL fins and staggered copper ducting heats the outside air to the specified setpoint temperature. Controlled by connecting a hydraulic unit (accessories) via the integrated

control board.
There is a continuous adjustment between the specification and the temperature measured by the room or duct sensor (ALB-ASD included in delivery).
A frost protection control is integrated as standard. Max. operating pressure 1.6 MPa.
Water connection pipe with male thread.

Electrical connection
Large terminal box protected to IP 20 on outside of casing.

Motor protection
Through thermal contact wired in series with the motor windings. Once the unit has cooled down, automatic reconnection takes place.

Sound levels
The table below also contains the sound pressure levels at 1 m (free field conditions).
If necessary, cross talk attenuators are available (accessory) for further acoustic reduction.

Information	Page
Techn. description	285
Information for planning	10 on

- Control**
The remote control is included in delivery and offers:
- 5-step operation.
 - Temperature control with connection from room and/or duct temperature sensor (included in delivery).
 - Anti-freeze protection.
 - Control of the hydraulic unit (accessory) for regulation of the WW-heater battery. Specification of min./max. temperature.
 - Operation of the extract air control ALB-ASD (accessories) for speed control of the extract fans.
 - Indication of surrounding temperature, fan speed and filter contamination (via differential pressure switch, accessory).
- Further inputs and outputs:**
- Automatic control of operation by means of week timer.
 - Fault cause reporting, alarm.
 - Input for air quality or humidity sensor.
 - Output for e.g. damper control.



Type	Ref. no.	Air flow volume* free discharge	Max. R.P.M.	Sound pressure level case breakout supply air noise		Voltage 50 Hz	Power consumption		Current max. total	Wiring diagram	Maximum supply air temp. for operation		Weight net approx.
		∇ m³/h (max.)	min ⁻¹	dB(A) at 1 m	dB(A) at 1 m		Motor	Heating			with heating	w/o heating	
ALB 280/4/60/35 WW	6501	4700	1450	57	74	400, 3N~	1.56	—	2.75	1122	20	40	110

* with standard filter, class G 4

ALB 280/4/60/35 WW

Frequency	Hz	Total	125	250	500	1k	2k	4k	8k
L _{WA} Case breakout	dB(A)	65	59	59	56	57	53	49	38
L _{WA} Extract	dB(A)	82	70	72	74	77	76	72	19
L _{WA} Intake	dB(A)	77	72	71	68	70	67	61	15

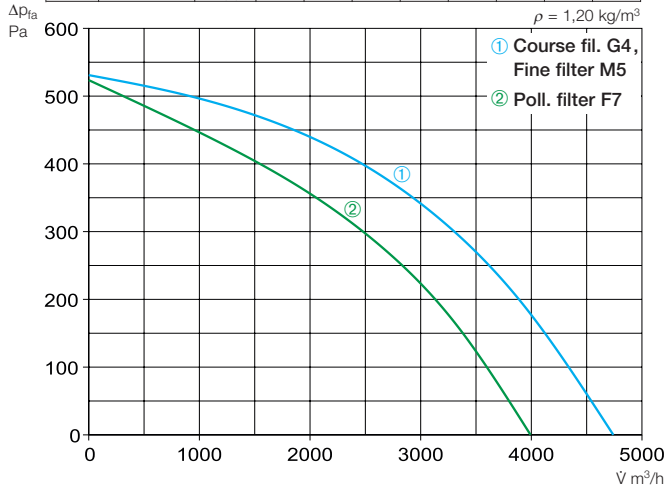

Other accessories	Page	Room sensors	Page
Attenuator	434	CO ₂ and humidity sensor	87 on
Details Hydraulic unit	432		
Flexible ducting, grilles, moulded parts shutters	487 on	Duct sensor for measuring the CO ₂ concentration or room air humidity in air ducts	upon request
Supply air valves	510		

Heat output WW heater ①-③

Diagrams ①-③ show the heat output in relation to the flow/return and outdoor temperature over air flow volume.

Water quantity WW heater ④

④ shows the water flow in relation to the flow/return and outdoor temperature over air flow volume.

Pressure loss WW heater ⑤

⑤ shows the water pressure loss over the water flow.

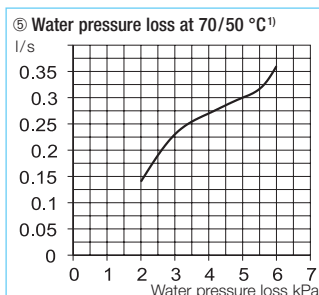
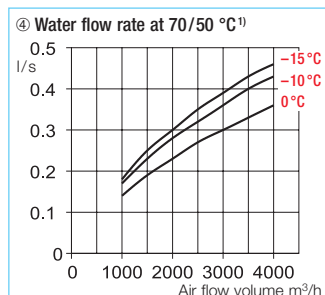
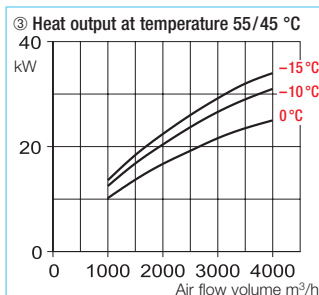
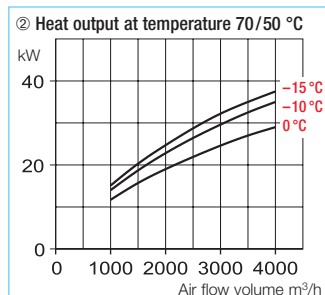
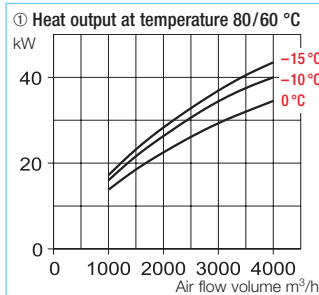

¹⁾ Correction factor for 80/50 °C: 1.16; for 55/45 °C: 1.81

Accessories

Hydraulic unit

WHSH HE 24 V (0-10 V) No. 8318

For regulation of the heat output of the water heater battery in connection with room/ duct sensor. Including flow/return temperature display, pump, servo motor, mixing valve, ball valve with integrated non-return valve, thermal casing and flexible connection hose.



Spare and pollen filters

Large surface pocket or cassette filters for long cleaning intervals, VDI 6022, DIN EN 779 compliant. Contents = 3 pcs.

- Filter class G4

ELF-ALB 280/4/60/35 G4 No. 3649

- Filter class M5

ELF-ALB 280/4/60/35 M5 No. 3650

- Filter class F7

ELF-ALB 280/4/60/35 F7 No. 3654



Differential pressure switch

Type DDS

Ref. no. 0445

Adjustable opener/closer for monitoring pressure loss.



Connection cable (extra long)

- 30 metres long

Type ALB-SK 30 Ref. no. 2517

- 50 metres long

Type ALB-SK 50 Ref. no. 2518

Connection between ALB and remote control and between ALB and ALB-ASD.

Adaptor - symmetrical

From device flange to circular ducting.

ALB-US 280/4/60/35 No. 7516

Flexible sleeve

For acoustic decoupling, incl. 2 hose clamps.

Type FM 355 Ref. no. 1675

Coupling flange ring made from galvanised sheet steel for connection to ducting.

Type FR 355 Ref. no. 1205

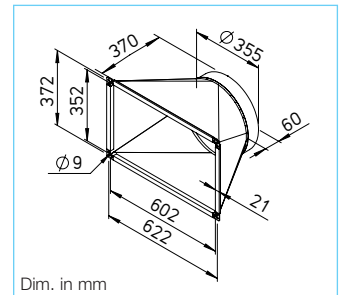

Dim. in mm

Extract air control

ALB-ASD 280/4/60/35 No. 3656

Control unit incl. duct temperature sensor for regulating an extract air fan in relation to the speed of the supply air fan.

Allows synchronised operation of the unit (supply and extract air) at five speed steps.

The control unit is connected with the supply systems by a control cable. The programming takes place in a few steps directly to the ALB-remote control

ALB-ASD is mountable in any position and allows the connection of one or many speed controllable 3 ph. fans up to nominal load.

Technical data

Voltage	400 V 3~, 50 Hz
Current max.	5 A
Protection class	IP 55
Dim. mm	W 390 x H 470 x D 135
Weight approx.	19,0 kg
Wiring diagram no.	1126



Perfectly coordinated system solutions from the leading supplier.

- The components are available in every size and every performance level.
- All the components are compatible with each other and fit exactly together.
- Short installation time, simple system planning and rational procurement.

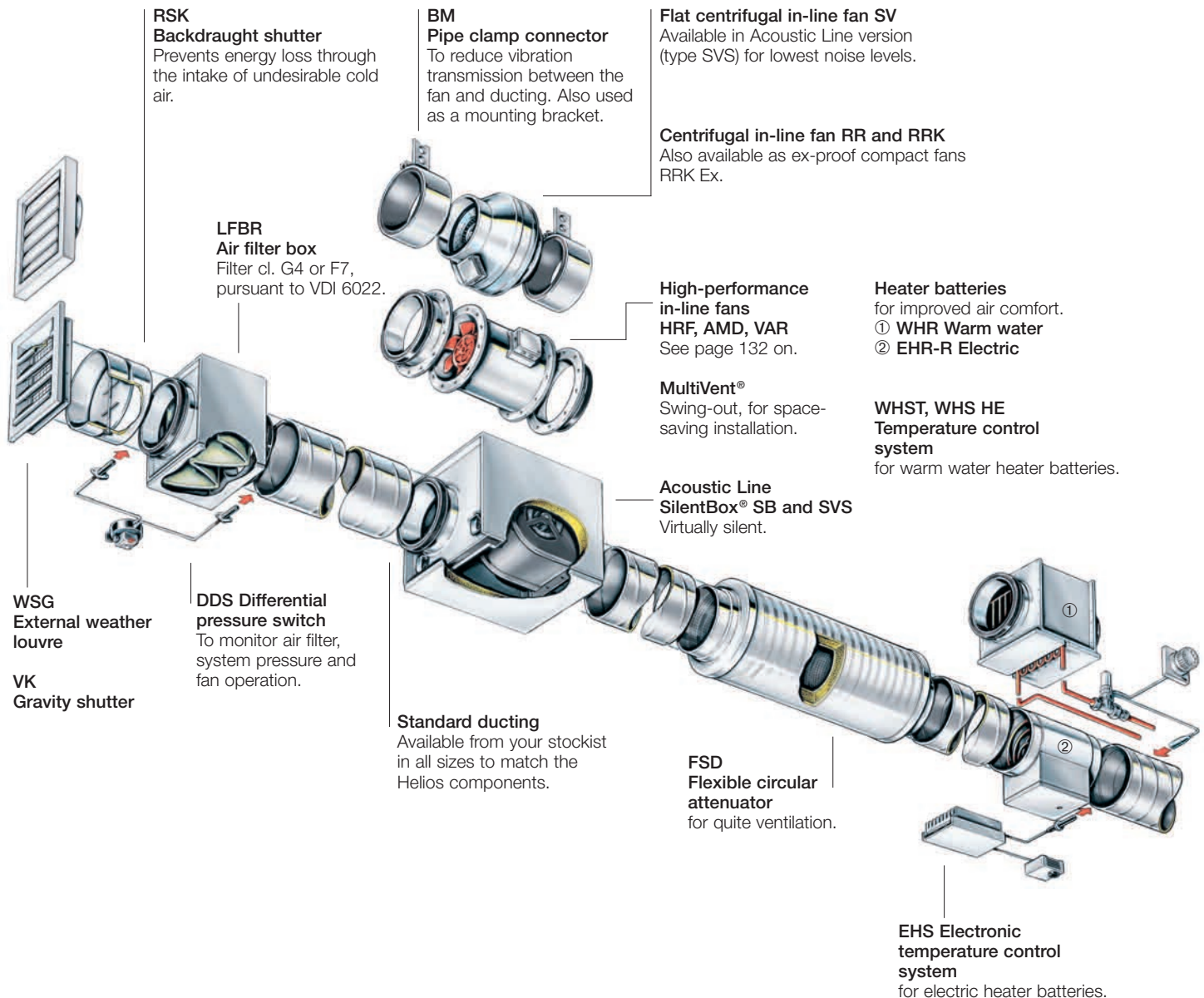

EX-PROOF
COMPACT FANS
RRK Ex e II 2G, 230 V~



316

CENTRIFUGAL
IN-LINE FANS
Product-specific information
Selection chart

296

MULTIVENT® MV
in-line fans



Compact in-line fans for space-saving installation in the ducting system.

Optional 5 types from ND 125 – 315 with highly-efficient EC motors for lowest operating costs.

298^{on}

INLINEVENT®
RR, RRK, SVR
in-line fans



RR, RRK: Available in galvansied sheet steel or corrosion-resistant polymer casing.

SlimVent: Ultra-flat, with swing-out motor-impeller unit.

Optional 14 types from ND 100 – 315 with highly-efficient EC motors for lowest operating costs.

318^{on}

ACOUSTIC LINE SB, SVS,
SilentBox® and SlimVent®
Sound-insulated
in-line fans



Virtually silent with high volume and pressure performance. SlimVent models for spatially restricted installation situations.

Optional 18 types from ND 125 – 400 with highly-efficient EC motors for lowest operating costs.

342^{on}

■ **Features**

In-line fans have the benefits of the axial construction design and straight-line flow pattern, simple and easy installation and have the performance characteristics of high-performance centrifugal fans. There are strong reasons to choose these devices:

- Low space requirements.
- Unlimited adjustability.
- Low installation effort.
- Cost-effective installation.
- Low noise.
- High pressure reserves.

■ **Structural form – Overview**

■ **MultiVent® MV**

High-pressures and volumes with the space-saving dimensions. Universally suited to all types of rooms at 190 to 1820 m³/h and over 800 Pa. 19 types of standard diameter from 100 to 250 mm in single-level and two-level and parallel design.

□ **MV EC**

Optional 5 types of standard diameter 125 – 315 with highly efficient EC motors for minimum operating costs.

■ **RR**

Market-leading solution with excellent price/performance ratio. Centrifugal in-line fans with low to medium power with standard diameters from 100 to 315 mm. Robust galvanised sheet steel casing.

□ **RR EC**

Optional 9 types of standard diameter 100 – 315 with highly efficient EC motors for minimum operating costs.

■ **RRK**

Alternative with corrosion-resistant and impact-resistant polymer casing in standard diameters from 100 to 315 mm.

■ **SVV, SVR**

Compact flat in-line fans from 80 to 200 mm. With energy-efficient centrifugal impellers to convey small to larger air flow volumes.

□ **SVR EC**

Optional 5 types of standard diameter 100 – 200 with highly efficient EC motors for minimum operating costs.

■ **RRK Ex**

Explosion-protected small fans for 230 V, 1 ph. alternating current. Particularly suited to ventilation of chemical and pharmaceutical laboratories, workshops, etc. To be fitted in the ducting, licensed for operation in zones 1, 2 and 11 according to DIN EN 60079/VDE 0165.

■ **Acoustic Line SB**

Helios SilentBox®, the almost silent solution for high-performance centrifugal fans with duct connection in standard diameters 125 to 400 mm.

□ **SB EC**

Optional 12 types of standard diameter 125 to 400 mm with highly efficient EC motors for minimum operating costs.

■ **Acoustic Line SVS**

Completely lined with sound-absorbing mineral wool. Extremely compact design. Ideal for suspended ceilings, with duct connection in standard diameters 125 to 200 mm.

□ **SVS EC**

Optional 6 types of standard diameter 125 – 315 with highly efficient EC motors for minimum operating costs.

■ **This information supplements the "General technical information" and statements on the product pages.**

□ **Installation position, mounting and condensation outlets**

All ranges (excluding SVR, SVS) can be fitted in any location. In the SV range, the pivoting range is to be kept free and unobstructed access for inspection and cleaning must be ensured. Where there is condensate water (e.g. intermittent operation, medium conveyed volume with high moisture content and changing temperatures), the system must be fitted such that condensate can run off downwards unobstructed. Corresponding drill holes may need to be made in the fan casing. In the RR types, condensate drain openings are fitted in the impeller disc and the motor casing. If necessary, the ducting is to be insulated such that no condensation forms.

□ **Transfer of structure-born sound**

to the ducting and building must be prevented. To this end, the fan must not be rigidly connected to the ducting. Suitable support brackets are available as accessories.

□ **Explosion-protected types**

Reference is made to the statements within the "Instructions for project planning regarding explosion protection" section with regard to the conditions of use and standard. Type RRK Ex models with explosion protection are in line with equipment group II, category 2G for operation in zone 1 and 2 in accordance with Directive 2014/34/EU (ATEX).

□ **Motor, impeller**

External rotor motors with degree of protection IP 44 located in the air flow are used in all construction designs. They are compliant with DIN EN 60034/VDE 0530 and DIN EN 60335-1/VDE 0700 and are equipped with additional moisture and damp protection in ISO class F. The EC types are equipped with particularly energy-saving EC external rotor motors with controllable speed. They are low-maintenance, interference-free and suitable for continuous operation (S1). The ball bearings have a sufficient supply of grease for their lifetime. The centrifugal impellers are pressed on the motor body, i.e. they are firmly connected to the motor and are

dynamically balanced as a single unit in accordance with DIN ISO 1940 T.1 – grade 6.3.

□ **Speed control**

All In-lineVent®, MultiVent® and Acoustic Line AC standard types can be regulated in terms of power from 0 to 100% by reducing the voltage. This means that the power can be set to the desired volume. The speed controllers on offer can operate one or more AC fans (until the maximum nominal current is reached). A 10% reserve is to be included in the sizing. Type SVV 80 can also be controlled using three-level switching and types SVR, SVS and RR using two-level switching. In all MultiVent® types (excluding MV EC 315), it is possible to regulate the system through two-level switching, while the AC standard types also have five-level transformer regulation. All EC types (excluding EC 125 to 250) can be steplessly controlled using a speed potentiometer. Furthermore, regulation with three-level switches or stepless regulation is possible using a universal control system or electronic differential pressure/temperature controller. Sample power levels are shown in the characteristic curve.

□ **Airflow direction**

The airflow direction cannot be changed for centrifugal fans, however, it can be defined in all devices according to the how the device is installed. The correct direction of motor rotation and airflow is marked by arrows and is to be checked upon commissioning.

□ **Incorrect direction of rotation**

Operating the device in an incorrect direction of rotation overloads the AC motor and trips the thermal contacts. Typical concomitant features for this are the practical lack of air flow capacity, vibration and abnormal noise.

□ **Air flow temperature**

All devices can be used in the range of –40 °C to at least +40 °C. The upper limit is type-specific and is shown in the table on the product page.

■ Note	
The integration of F7 air filters and differential pressure switches DDS (Ref. no. 0445) in outside air systems fulfils the requirements of VDI 6022.	
■ Information	Page
Information for planning, Acoustics, explos. protect.	10 on
General techn. information, speed control	15 on

MultiVent® in-line fans. As thin as the ducting system.

SPACE-SAVING

With a volume of 190 to 1820 m³/h and pressure of over 800 Pa (given a two-level configuration), Helios MultiVent® is suitable for ventilation of small to medium-sized rooms of all kinds.

Its specific advantage is its small size. The casing diameter is only slightly bigger than the ventilation duct. It can be installed in any location – horizontally, vertically or diagonally.

ROTATES AS REQUIRED

The installation of Helios MultiVent® is space-saving as it fits directly in the ducting. It is ideal in areas where it gets narrow, e.g. under suspended ceilings.

The casing and integrated bracket can be fitted in any location and the fan unit with the terminal box can be rotated as required. The fan unit is easy to remove by loosening the clamps.

FREELY ACCESSIBLE

This device design guarantees the simplest possible installation in the ducting and unproblematic maintenance and cleaning where necessary. The concept satisfies the requirements of VDI 6022. The energy-saving capacitor motors (degree of protection IP 44) are equipped with ball bearings for 30.000 operating hours and fully closed. This means that they can even be used when air is contaminated and contains dust.



In-line fans

Energy-efficient
EC version

Ø 125 – 315 mm
V = 360 – 2050 m³/h

300^{on}

Standard AC types
available in two-speed
or parallel design

Ø 100 – 250 mm
V = 190 – 1820 m³/h

304^{on}

MV EC

Swing-out EC in-line fan for space-saving installation in ducting.

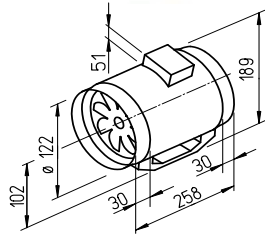

Dim. in mm

Energy-saving EC in-line fan with high pressure and volumetric performance with space-saving dimensions.

Specifically made for in-duct installation. Diverse applications in commercial, industrial and residential areas.

Special features

- Highly efficient EC motor for lowest operating costs.
- Less space required and simple site installation of the compact in line design.
- Its simplicity reduces site costs.
- Supply and exhaust air spigots fit all standard circular duct sizes.
- Two speeds as standard; 100% speed-controllable.
- Installation in any position.
- Longlife ball bearings, designed for 30.000 operating hours.
- simple maintenance and cleaning without dismantling the ducting system due to removable fan unit.
- Fan unit with terminal box can be rotated to any position.
- Integrated mounting bracket for simple wall and ceiling installation.

Specification

- Casing**
The fan unit can be removed from the casing with integrated mounting bracket by loosening the clamps.
All components made from impact and corrosion resistant polymers. Colour: Light grey.

Impeller

Optimised for high pressure and volumetric performance, made from high quality polymers. Dynamically balanced for silent operation.

Motor

Energy-saving, speed-controlable EC external rotor motor protected to IP 44 with high efficiency level and humidity protection. Maintenance-free and interference-free, ball bearing mounted.

Electrical connection

Large terminal box (IP 44) on outside of casing; can be rotated to any position.

MV EC 125

Frequency	Hz	Total	125	250	500	1k	2k	4k	8k
L _{WA} Case breakout	dB(A)	50	27	44	45	46	40	36	32
L _{WA} Intake	dB(A)	62	33	56	56	55	53	47	40
L _{WA} Exhaust	dB(A)	63	34	57	58	59	54	48	42

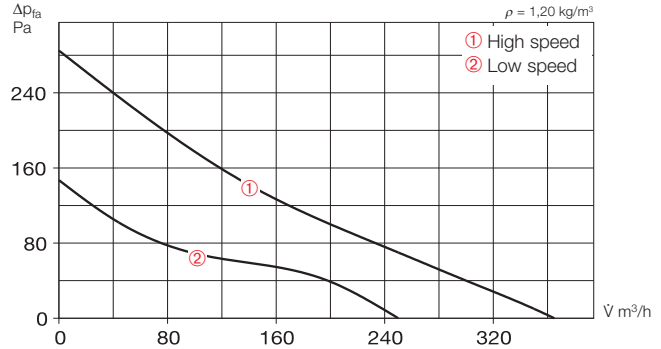

	Free discharge					
	n min ⁻¹	V̇ m³/h	P W	I A	Lp dB(A)	SFP kW/m²/s
High speed	2040	365	15	0,13	42	0,15
Low speed	1600	250	9	0,09	37	0,13

Motor protection

Integrated electronic temperature monitoring for EC motor and electronics.

Speed control

Standard two-speed control with external operating switch MVB (accessory).

Installation

Can be mounted in any position – horizontal, vertical or diagonal – suitable for supply and extract ventilation by correct installation. To minimise the effective noise level it is recommended that the fan is installed as remote as possible from the ventilated space.

Sound levels

Sum levels and spectrum figures are indicated above characteristic curves for:

- Sound level case breakout
 - Sound level intake
 - Sound level exhaust
- The sound pressure level at 1 m (free field conditions) can be seen in the table below and below the performance curve.

Accessory details	Page
Filters, heater batteries and attenuators	421 on
Temperature control systems for heater batteries	427, 431
Flexible ventilation ducting, grilles, adaptors, Roof terminations	487 on
Poppet valves	508 on
Speed controllers and switches	525 on

Type	Ref. no.	Connection Ø	Air flow volume (FID)	Nominal R.P.M.	Sound press. case breakout	Motor power	Current	Wiring diagram	max. air flow temperature	Weight net approx.	Operating switch
		mm	V̇ m³/h	min ⁻¹	dB(A) in 1 m	kW	A	No.	+ °C	kg	Type Ref. no.
Single phase motor, 230 V, 50 Hz, EC motor											
MV EC 125	6032	125	250/360	1600/2040	38/42	0.010/0.017	0.10/0.17	951	60	1.8	MVB 6091

MV EC

Swing-out EC in-line fan for space-saving installation in ducting.

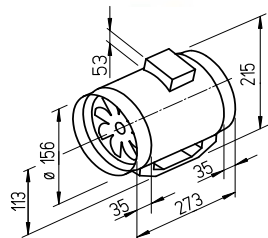

Dim. in mm

60% Saving*
* with speed control

Energy-saving EC in-line fan with high pressure and volumetric performance with space-saving dimensions.

Specifically made for in-duct installation. Diverse applications in commercial, industrial and residential areas.

Special features

- Highly efficient EC motor for lowest operating costs.
- Less space required and simple site installation of the compact in line design.
- Its simplicity reduces site costs.
- Supply and exhaust air spigots fit all standard circular duct sizes.
- Two speeds as standard; 100% speed-controllable.
- Installation in any position.
- Longlife ball bearings, designed for 30.000 operating hours.
- simple maintenance and cleaning without dismantling the ducting system due to removable fan unit.
- Fan unit with terminal box can be rotated to any position.
- Integrated mounting bracket for simple wall and ceiling installation.

Specification

Casing

The fan unit can be removed from the casing with integrated mounting bracket by loosening the clamps. All components made from impact and corrosion resistant polymers. Colour: Light grey.

Impeller

Optimised for high pressure and volumetric performance, made from high quality polymers. Dynamically balanced for silent operation.

Motor

Energy-saving, speed-controllable EC external rotor motor protected to IP 44 with high efficiency level and humidity protection. Maintenance-free and interference-free, ball bearing mounted.

Electrical connection

Large terminal box (IP 44) on outside of casing; can be rotated to any position.

MV EC 160

Frequency	Hz	Total	125	250	500	1k	2k	4k	8k	
L _{WA}	Case breakout	dB(A)	55	27	44	43	48	53	44	36
L _{WA}	Intake	dB(A)	69	39	57	62	61	67	58	48
L _{WA}	Exhaust	dB(A)	68	36	56	61	63	62	59	48

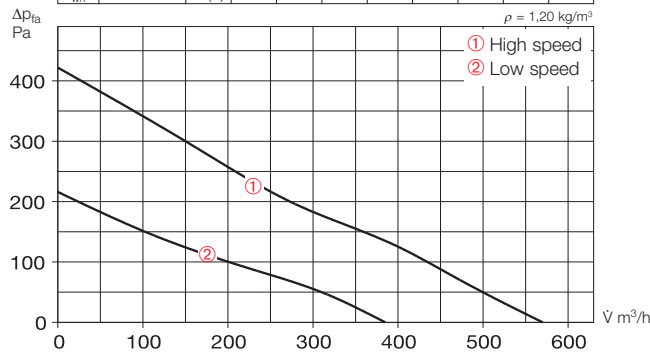

	n min ⁻¹	V̇ m³/h	P W	I A	Lp dB(A)	SFP kW/m³/s
High speed	2290	570	34	0,30	47	0,21
Low speed	1560	385	14	0,12	39	0,13

Motor protection

Integrated electronic temperature monitoring for EC motor and electronics.

Speed control

Standard two-speed control with external operating switch MVB (accessory).

Installation

Can be mounted in any position – horizontal, vertical or diagonal – suitable for supply and extract ventilation by correct installation. To minimise the effective noise level it is recommended that the fan is installed as remote as possible from the ventilated space.

Sound levels

Sum levels and spectrum figures are indicated above characteristic curves for:

- Sound level case breakout
- Sound level intake
- Sound level exhaust

The sound pressure level at 1 m (free field conditions) can be seen in the table below and below the performance curve.

Accessory details Page

Filters, heater batteries and attenuators	421 on
Temperature control systems for heater batteries	427, 431
Flexible ventilation ducting, grilles, adaptors, Roof terminations	487 on
Poppet valves	508 on
Speed controllers and switches	525 on

Type	Ref. no.	Connection Ø	Air flow volume (FID)	Nominal R.P.M.	Sound press case breakout	Motor power	Current	Wiring diagram	max. air flow temperature	Weight net approx.	Operating switch
		mm	V̇ m³/h	min ⁻¹	dB(A) in 1 m	kW	A	No.	+ °C	kg	Type Ref. no.
Single phase motor, 230 V, 50 Hz, EC motor											
MV EC 160	6033	160	385/570	1560/2290	39/47	0.015/0.038	0.15/0.33	951	60	2.1	MVB 6091

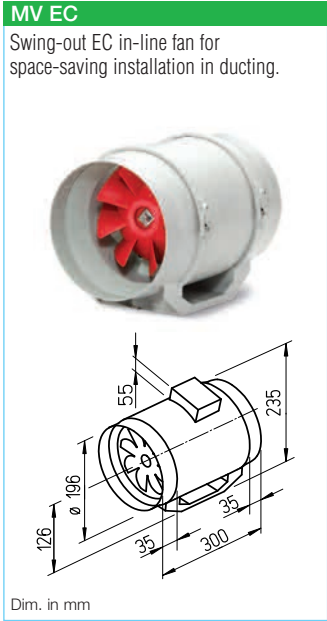

Energy-saving EC in-line fan with high pressure and volumetric performance with space-saving dimensions.

Specifically made for in-duct installation. Diverse applications in commercial, industrial and residential areas.

Special features

- Highly efficient EC motor for lowest operating costs.
- Less space required and simple site installation of the compact in line design.
- Its simplicity reduces site costs.
- Supply and exhaust air spigots fit all standard circular duct sizes.
- Two speeds as standard; 100% speed-controllable.
- Installation in any position.
- Longlife ball bearings, designed for 30.000 operating hours.
- simple maintenance and cleaning without dismantling the ducting system due to removable fan unit.
- Fan unit with terminal box can be rotated to any position.
- Integrated mounting bracket for simple wall and ceiling installation.

Specification

- Casing**
The fan unit can be removed from the casing with integrated mounting bracket by loosening the clamps. All components made from impact and corrosion resistant polymers. Colour: Light grey.

- Impeller**
Optimised for high pressure and volumetric performance, made from high quality polymers. Dynamically balanced for silent operation.

- Motor**
Energy-saving, speed-controlable EC external rotor motor protected to IP 44 with high efficiency level and humidity protection. Maintenance-free and interference-free, ball bearing mounted.

- Electrical connection**
Large terminal box (IP 44) on outside of casing; can be rotated to any position.

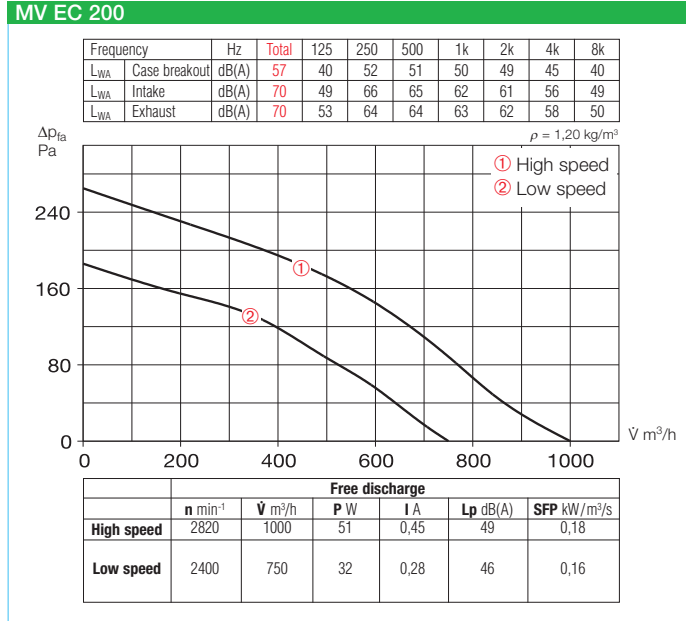

- Motor protection**
Integrated electronic temperature monitoring for EC motor and electronics.

- Speed control**
Standard two-speed control with external operating switch MVB (accessory).

- Installation**
Can be mounted in any position – horizontal, vertical or diagonal – suitable for supply and extract ventilation by correct installation. To minimise the effective noise level it is recommended that the fan is installed as remote as possible from the ventilated space.

- Sound levels**
Sum levels and spectrum figures are indicated above characteristic curves for:
– Sound level case breakout
– Sound level intake
– Sound level exhaust
The sound pressure level at 1 m (free field conditions) can be seen in the table below and below the performance curve.

Accessory details	Page
Filters, heater batteries and attenuators	421 on
Temperature control systems for heater batteries	427, 431
Flexible ventilation ducting, grilles, adaptors, Roof terminations	487 on
Poppet valves	508 on
Speed controllers and switches	525 on

Type	Ref. no.	Connection Ø	Air flow volume (FID)	Nominal R.P.M.	Sound press. case breakout	Motor power	Current	Wiring diagram	max. air flow temperature	Weight net approx.	Operating switch
		mm	V m ³ /h	min ⁻¹	dB(A) in 1 m	kW	A	No.	+ °C	kg	Type Ref. no.
Single phase motor, 230 V, 50 Hz, EC motor											
MV EC 200	6034	200	750/1000	2400/2820	46/49	0.036/0.057	0.33/0.50	951	50	2.5	MVB 6091

MV EC 250

Swing-out EC in-line fan for space-saving installation in ducting.

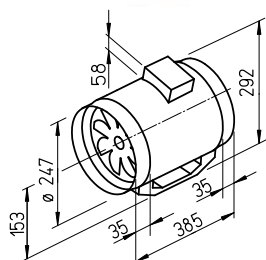

Dim. in mm

MV EC 315

Swing-out EC in-line fan for space-saving installation in ducting.

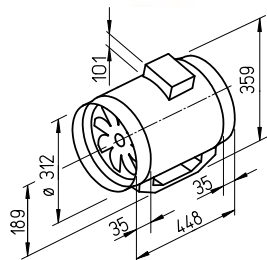

Dim. in mm

Energy-saving EC in-line fan with high pressure and volumetric performance with space-saving dimensions.

Specifically made for in-duct installation. Diverse applications in commercial, industrial and residential areas.

■ Specification

□ Casing

The fan unit can be removed from the casing with integrated mounting bracket by loosening the clamps.

All components made from impact and corrosion resistant polymers. Colour: Light grey.

□ Impeller

Optimised for high pressure and volumetric performance, made from high quality polymers. Dynamically balanced for silent operation.

□ Motor

Energy-saving, speed-controllable EC external rotor motor protected to IP 44 with high efficiency level and humidity protection. Maintenance-free and interference-free, ball bearing mounted.

□ Electrical connection

Large terminal box (IP 44) on outside of casing; can be rotated to any position.

□ Motor protection

Integrated electronic temperature monitoring for EC motor and electronics.

□ Speed control

Standard two speed control for type MV EC 250 by means of external operating switch MVB. Stepless speed control for type MV EC 315 in the range between the min. and max. speed stages with potentiometer PU and commercial on/off switch (light switch), see table.

□ Installation

Can be mounted in any position – horizontal, vertical or diagonal – suitable for supply and extract ventilation by correct installation. To minimise the effective noise level it is recommended that the fan is installed as remote as possible from the ventilated space.

■ Sound levels

Sum levels and spectrum figures are indicated above characteristic curves for:

- Sound level case breakout
- Sound level intake
- Sound level exhaust

The sound pressure level at 1 m (free field conditions) can be seen in the table below and below the performance curve.

MV EC 250

Frequency	Hz	Total	125	250	500	1k	2k	4k	8k
L _{WA} Case breakout	dB(A)	58	40	49	52	51	53	47	39
L _{WA} Intake	dB(A)	73	55	66	68	68	66	58	49
L _{WA} Exhaust	dB(A)	73	54	65	68	67	68	61	51

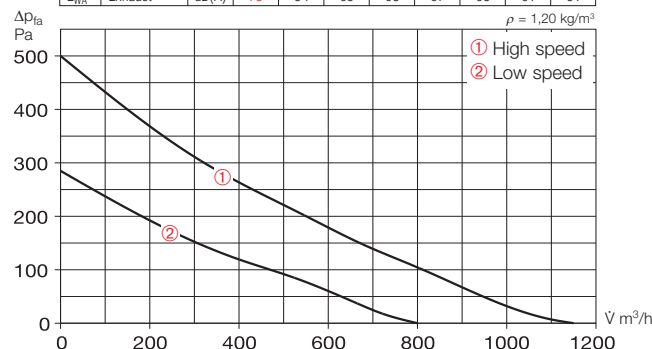

	n min ⁻¹	V̇ m³/h	P W	I A	Lp dB(A)	SFP kW/m³/s
High speed	2750	1150	95	0,83	50	0,29
Low speed	2100	800	45	0,42	44	0,20

MV EC 315

Frequency	Hz	Total	125	250	500	1k	2k	4k	8k
L _{WA} Case breakout	dB(A)	62	42	54	55	58	57	50	40
L _{WA} Intake	dB(A)	76	56	67	69	71	70	63	53
L _{WA} Exhaust	dB(A)	76	55	66	68	70	71	64	54

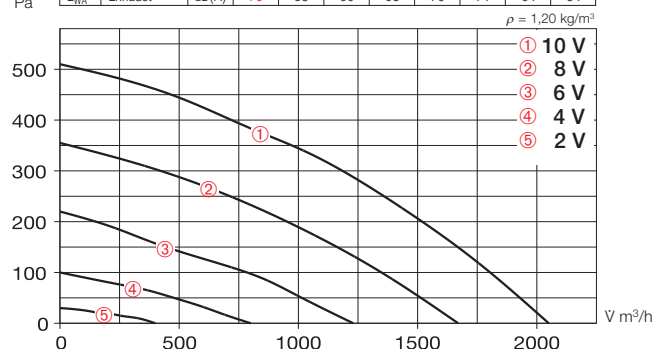

Voltage V	n min ⁻¹	V̇ m³/h	P W	I A	Lp dB(A)	SFP kW/m³/s
10	2350	2050	240	1,70	54	0,42
8	1940	1670	140	1,00	50	0,30
6	1470	1230	70	0,54	44	0,21
4	1000	800	30	0,25	36	0,14



■ Accessory details Page

Filters, heater batteries and attenuators	421 on
Temperature control systems for heater batteries	427, 431
Flexible ventilation ducting, grilles, adaptors,	
Roof terminations	487 on
Poppet valves	508 on
Speed controllers and switches	525 on

Type	Ref. no.	Connection Ø	Air flow volume (FID)	Nominal R.P.M.	Sound press. case breakout	Motor power	Current	Wiring diagram	max. air flow temperature	Weight net approx.	Operating switch	
		mm	V̇ m³/h	min ⁻¹	dB(A) in 1 m	kW	A	No.	+ °C	kg	Type	Ref. no.
Single phase motor, 230 V, 50 Hz, EC motor												
MV EC 250	6035	250	800/1150	2100/2750	44/50	0.045/0.095	0.42/0.83	951	50	5.3	MVB	6091
MV EC 315	6036	315	2050	2350	54	0.280	1.97	1058	50	9.5	PU 10¹⁾	1734

¹⁾ alternative potentiometer for flush mounting (PA 10, No. 1735) or three-step speed switch (SU/SA, No. 4266/4267), see Accessories

High air flow volume and high pressure characteristic in a space saving design.

Specifically made for in-duct installation. Versatile for use in most commercial, industrial and domestic applications.

Special features

- Less space required and simple site installation of the compact in line design.
- Its simplicity reduces site costs.
- Supply and exhaust air spigots fit all standard circular duct sizes.
- Two speeds, as standard; plus fully controllable motor speed
- Installation in any position.
- Long life ball bearings, designed for 30.000 operating hours.
- Trouble-free maintenance and cleaning by removing the core of the unit from its frame without disassembling the ducting.
- Fan unit with terminal box can be rotated to any position.
- Integral mounting bracket for easy installation on floor, wall and ceiling.

Common features

- Casing**
By loosening the clips the fan section can be removed from the casing leaving the mounting bracket. All components are manufactured from impact resistant and corrosion resistant polymer. Colour: Light grey.
- Speed control**
Standard two-speed control with external operating switch MVB (accessory). Full speed control with an electronic controller or five-step transformer.
- Motor**
Totally enclosed ball bearing motor made for continuous operation with insulation class F and moisture protection. Maintenance-free and interference-free.
- Motor protection**
Thermal overload protection fitted in the winding as standard.
- Sound levels**
See explanations on page 307.

MV – Single-stage

Swing-out in-line fan for space-saving installation in ducting.

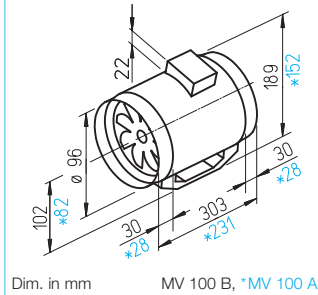

Specification MV

- Impeller**
Optimised for high pressure and volumetric performance, made from high grade polymer.
- Electrical connection**
The spacious terminal box (IP 44) is mounted on the casing; rotatable to any position.
- Installation**
Can be mounted in any position – horizontal, vertical or diagonal – suitable for supply and extract ventilation by correct installation. To minimise the effective noise level it is recommended that the fan is installed as remote as possible from the ventilated space.

MVZ – Two-stage

For higher pressure performance: Two in-line fans mounted in series.

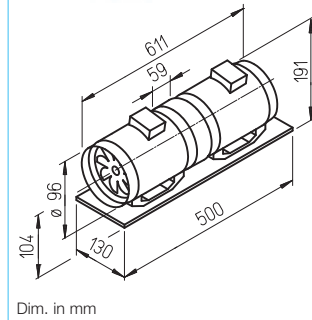

Specification MVZ

- Impeller**
Two MV fans are connected in series using a connecting sleeve and assembled on a common base plate. Delivered as ready-to-assemble kits. Series operation doubles the pressure output at the same volume.
- Impeller**
As described on the left.
- Electrical connection**
Each fan has a separate terminal box on the outer casing. By operating the two fans on two speeds using one operation switch MVB (accessory) or one change-over switch (on site) a coupling relay has to be used as shown in the wiring diagram. When using a speed controller, the high speed amps have to be allowed for.
- Installation**
Can be mounted in any position – horizontal, vertical or diagonal – suitable for supply and extract ventilation by correct installation. To minimise the effective noise level it is recommended that the fan is installed as remote as possible from the ventilated space.

MVP – Parallel

For higher volume output in a compact parallel design.

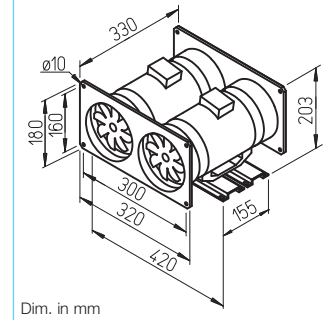

Specification MVP

- Impeller**
The two parallel MV fans are mounted on common mounting rails and have a connector plate fitted to both the intake and exhaust. Delivered as ready-to-assemble kits. Parallel operation (both fans running) doubles the air volume at the same pressure.
- Impeller**
As described on the left.
- Speed control / Connection**
Each fan is located with a separate terminal box on the outer casing. By operating the two fans on two speeds using one operation switch MVB (accessory) or one change-over switch (on site) a pair of relays have to be used as shown in the wiring diagram. When using a speed controller, the high speed amps have to be allowed for. Each fan can also be operated separately or together when necessary. To prevent the recirculation, two exhaust back draught shutters are required (RSK, accessory).

Type	Ref. no.	Connection Ø	Air flow volume min./max.	R.P.M. min./max.	Sound pressure level in 1 m case breakout		Power consumption min./max.	Current min./max.	Wiring diagram	Max. air flow temperature	Weight net approx.	Transformer-speed controller 5-step		Electronic* speed controller, stepless flush/surface	
					dB (A)	dB (A)						Type	Ref. no.	Type	Ref. no.
Single-stage in-line fan, 230 V, 50 Hz, capacitor motor, IP 44															
MV 100 A	6050	100	150/190	2070/2620	34/38	45/50	12/15	0.05/0.07	844.1	60	1.2	TSW 0,3	3608	ESU 1/ESA 1	0236/0238
MV 100 B	6051	100	170/240	1590/2170	32/38	46/52	20/23	0.09/0.11	844.1	60	1.7	TSW 0,3	3608	ESU 1/ESA 1	0236/0238
Two-stage in-line fan, 230 V, 50 Hz, capacitor motor, IP 44															
MVZ 100 B	6058	100	170/240	1590/2170	37/43	49/55	40/46	0.18/0.22	845.1	60	4.5	TSW 0,3	3608	ESU 1/ESA 1	0236/0238
Parallel-twin-unit, 230 V, 50 Hz, capacitor motor, IP 44															
MVP 100 B	6065	—	340/480	1590/2170	35/41	49/55	40/46	0.18/0.22	845.1	60	5.7	TSW 0,3	3608	ESU 1/ESA 1	0236/0238

* In noise sensitive cases, transformer-control devices should be used. Electronic phase angle control may generate disturbing increase in motor noise.

MV 100 A – Single-stage

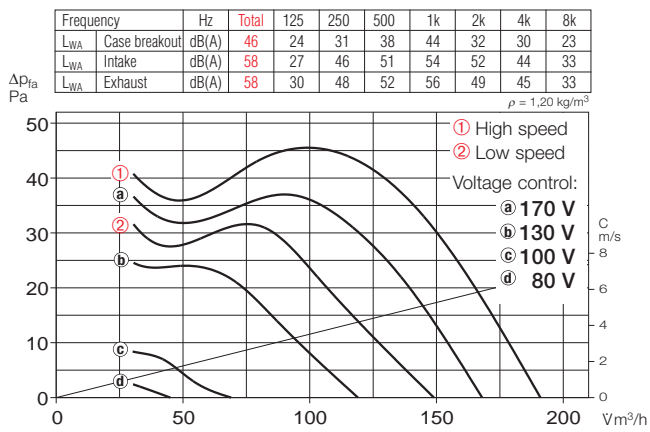

MV 100 B – Single-stage

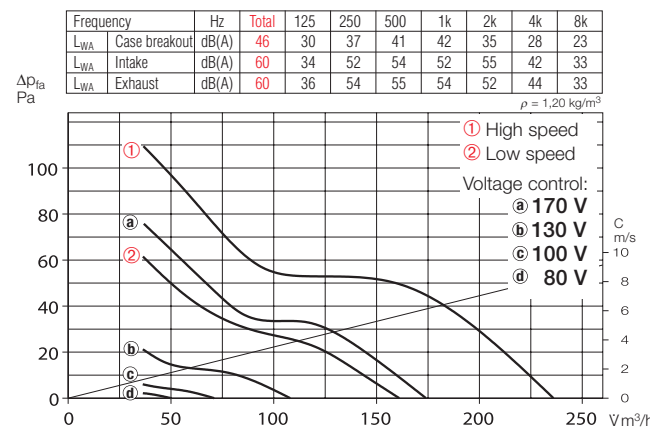

MVZ 100 B – Two-stage

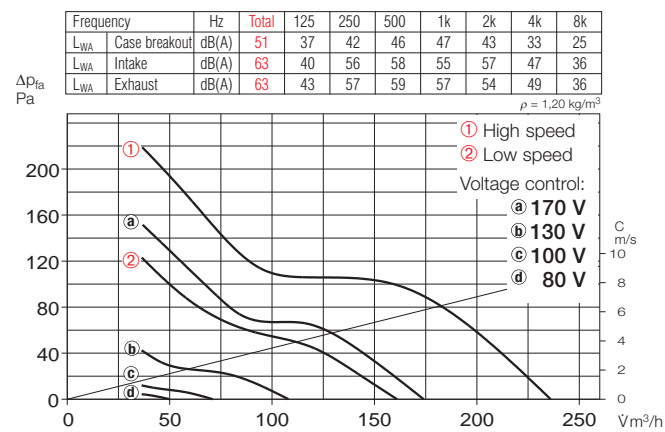

MVP 100 B – Parallel

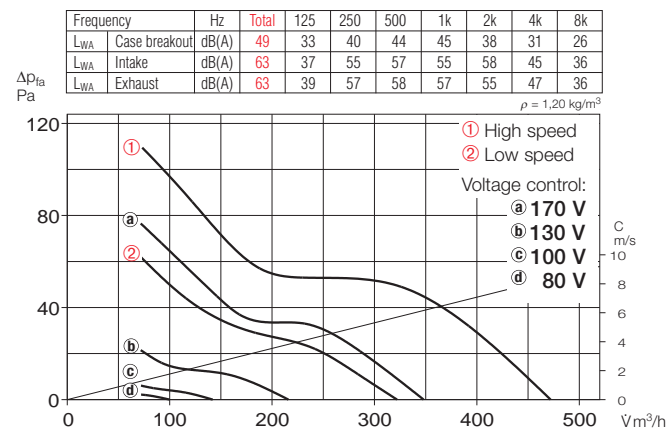

Accessories for MV and MVZ

Flexible connector

Type FM 100 Ref. no. 1681

Supplied with two hose clips as standard; for installation between fan and duct system. Prevents sound and vibration transmission and compensates small misalignments on site. Two sleeves are needed for intake and exhaust operation.



Gravity shutter

Type VK 100 Ref. no. 0757

Wall mounted, automatic pressure control shutter for the air outlet. Made of white polymer.



External wall grille

Type G 100 Ref. no. 0796

To cover or insert into circular ventilation holes. Made of impact resistant, white polymer.



Guard

Type MVS 100 Ref. no. 6071

For intake and exhaust installation on the ventilation unit.



Spigotted attenuator

Type FSD 100 Ref. no. 0676

Made from aluminium with plug sockets on both sides. With 50 mm insulation, length 1 m.



Air filter box

LFBR 100 G4 Ref. no. 8576

With a large cross section area, for in-duct installation.



Electric heater batteries

EHR-R 0,4/100 0,4 kW No. 8708

In circular casing, made of galvanised steel.

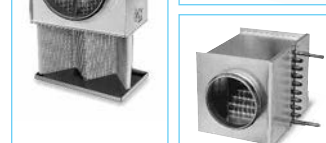

Warm-water heater batteries

Type WHR 100 Ref. no. 9479

For in-duct installation.

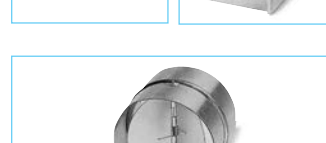

Accessories for all types

Back draught shutter

Type RSKK 100 Ref. no. 5106

Automatic, made of polymer. For in-duct installation.



Operating switch 0-1-2

Type MVB Ref. no. 6091

With on/off, low and high speed functions.



Transformer speed controller

Type TSW see table

Five-step, for surface mounting.



Electronic speed controller

Type ESU/ESA see table

For flush-/surface mounting.



Electronic run-on switch

Type ZNE Ref. no. 0342

With continuously adjustable follow-up time.



High air flow volume and high pressure characteristic in a space saving design.

Specifically made for in-duct installation. Versatile for use in most commercial, industrial and domestic applications.

Special features

- Less space required and simple site installation of the compact in line design.
- Its simplicity reduces site costs.
- Supply and exhaust air spigots fit all standard circular duct sizes.
- Two speeds, as standard; plus fully controllable motor speed
- Installation in any position.
- Long life ball bearings, designed for 30.000 operating hours.
- Trouble-free maintenance and cleaning by removing the core of the unit from its frame without disassembling the ducting.
- Fan unit with terminal box can be rotated to any position.
- Integral mounting bracket for easy installation on floor, wall and ceiling.

Common features

- Casing**
By loosening the clips the fan section can be removed from the casing leaving the mounting bracket. All components are manufactured from impact resistant and corrosion resistant polymer. Colour: Light grey.
- Speed control**
Standard two-speed control with external operating switch MVB (accessory). Full speed control with an electronic controller or five-step transformer.
- Motor**
Totally enclosed ball bearing motor made for continuous operation with insulation class F and moisture protection. Maintenance-free and interference-free.
- Motor protection**
Thermal overload protection fitted in the winding as standard.

MV – Single-stage

Swing-out in-line fan for space-saving installation in ducting.

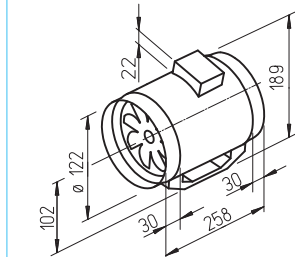

Dim. in mm

Specification MV

- Impeller**
Optimised for high pressure and volumetric performance, made from high grade polymer.
- Electrical connection**
The spacious terminal box (IP 44) is mounted on the casing; rotatable to any position.
- Installation**
Can be mounted in any position – horizontal, vertical or diagonal – suitable for supply and extract ventilation by correct installation. To minimise the effective noise level it is recommended that the fan is installed as remote as possible from the ventilated space.

MVZ – Two-stage

For higher pressure performance: Two in-line fans mounted in series.

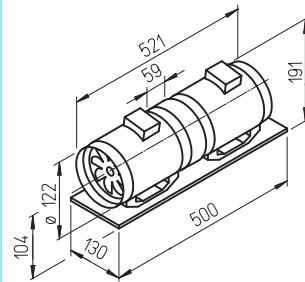

Dim. in mm

Specification MVZ

- Impeller**
Two MV fans are connected in series using a connecting sleeve and assembled on a common base plate. Delivered as ready-to-assemble kits. Series operation doubles the pressure output at the same volume.
- Impeller**
As described on the left.
- Electrical connection**
Each fan has a separate terminal box on the outer casing. By operating the two fans on two speeds using one operation switch MVB (accessory) or one change-over switch (on site) a coupling relay has to be used as shown in the wiring diagram. When using a speed controller, the high speed amps have to be allowed for.
- Installation**
Can be mounted in any position – horizontal, vertical or diagonal – suitable for supply and extract ventilation by correct installation. To minimise the effective noise level it is recommended that the fan is installed as remote as possible from the ventilated space.

MVP – Parallel

For higher volume output in a compact parallel design

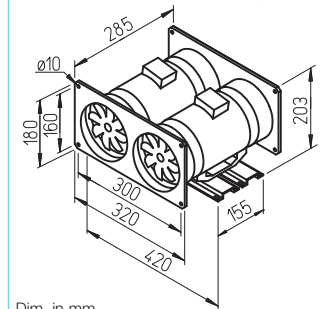

Dim. in mm

Specification MVP

- Impeller**
The two parallel MV fans are mounted on common mounting rails and have a connector plate fitted to both the intake and exhaust. Delivered as ready-to-assemble kits. Parallel operation (both fans running) doubles the air volume at the same pressure.
- Impeller**
As described on the left.
- Speed control / Connection**
Each fan is located with a separate terminal box on the outer casing. By operating the two fans on two speeds using one operation switch MVB (accessory) or one change-over switch (on site) a pair of relays have to be used as shown in the wiring diagram. When using a speed controller, the high speed amps have to be allowed for. Each fan can also be operated separately or together when necessary. To prevent the recirculation, two exhaust back draught shutters are required (RSK, accessory).

Type	Ref. no.	Connection Ø	Air flow volume min./max.	R.P.M. min./max.	Sound pressure level in 1 m case breakout		Power consumption min./max.	Current min./max.	Wiring diagram	Max. air flow temperature	Weight net approx.	Transformer-speed controller 5-step		Electronic* speed controller, stepless flush/surface	
					dB (A)	dB (A)						Type	Ref. no.	Type	Ref. no.
Single-stage in-line fan, 230 V, 50 Hz, capacitor motor, IP 44															
MV 125	6052	125	250/360	1670/2300	35/42	49/56	25/33	0.11/0.15	844.1	60	1.7	TSW 0,3	3608	ESU 1/ESA 1	0236/0238
Two-stage ventilation unit, 230 V, 50 Hz, capacitor motor, IP 44															
MVZ 125	6059	125	250/360	1670/2300	40/47	52/59	50/66	0.22/0.30	845.1	60	4.6	TSW 0,3	3608	ESU 1/ESA 1	0236/0238
Parallel-twin-unit, 230 V, 50 Hz, capacitor motor, IP 44															
MVP 125	6066	—	500/720	1670/2300	38/45	52/59	50/66	0.22/0.30	845.1	60	5.8	TSW 0,3	3608	ESU 1/ESA 1	0236/0238

* In noise relevant cases, transformer-control devices shall be provided. Electronic phase angle control may generate disturbing increase in motor noise.

MV 125 – Single-stage

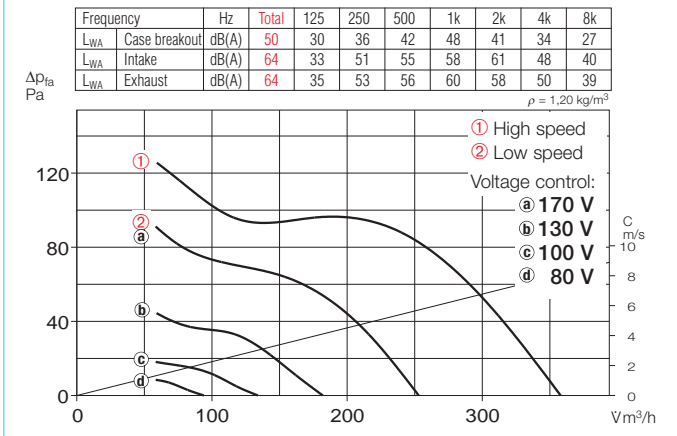

MVZ 125 – Two-stage

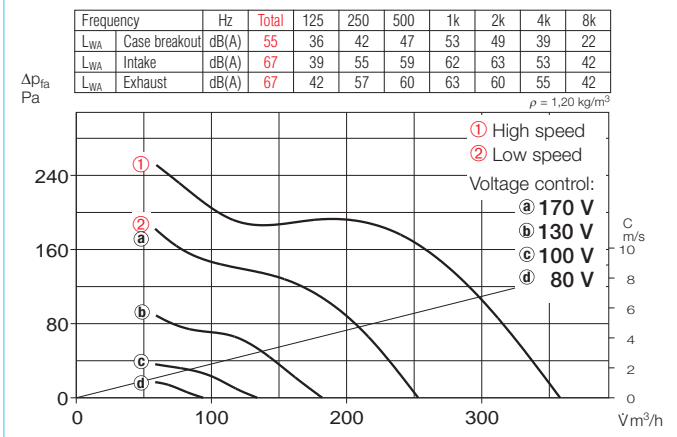

MVP 125 – Parallel

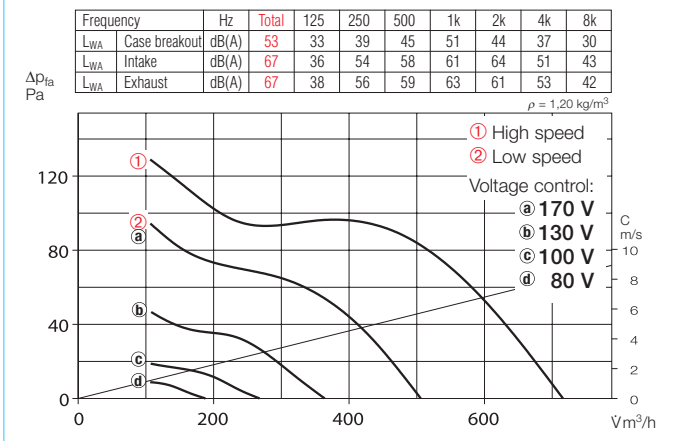

■ Sound levels

The total values and the spectrum figures are given above the performance curves for

- Sound level case breakout
- Sound level intake and exhaust air in dB(A)
- On the table (see left page)
- The case breakout figures and the intake/exhaust air noise levels are additionally given as sound pressure level at 1 m (free-field conditions).

The Helios figures have to be reduced by 8 dB(A) if compared to sound pressure levels at 3 m.

■ Accessory details Page

Filters, heater batteries and attenuators	421 on
Temperature controllers for heater batteries	427, 431
Flexible ventilation ducting, grilles, adaptors, roof terminations	487 on
Poppet valves	508 on
Speed controllers and switches	525 on

■ Accessories for MV and MVZ

Flexible connector

Type FM 125 Ref. no. 1682

Supplied with two hose clips as standard; for installation between fan and duct system. Prevents sound and vibration transmission and compensates small misalignments on site. Two sleeves are needed for intake and exhaust operation.



Gravity shutter

Type VK 125 Ref. no. 0857

Wall mounted, automatic pressure control shutter for the air outlet. Made of white polymer.



External wall grille

Type G 160 Ref. no. 0893

To cover or insert into circular ventilation holes. Made of impact resistant, white polymer.



Guard

Type MVS 125 Ref. no. 6072

For intake and exhaust installation on the ventilation unit.



Spigotted attenuator

Type FSD 125 Ref. no. 0677

Made from aluminium with plug sockets on both sides. With 50 mm insulation, length 1 m.



Air filter box

LFBR 125 G4 Ref. no. 8577

With a large cross section area, for in-duct installation.



Electric heater batteries

EHR-R 0,8/125 0,8 kW No. 8709

In circular casing, made of galvanised steel.

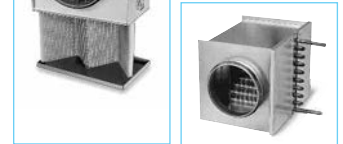

Warm-water heater batteries

Type WHR 125 Ref. no. 9480

For in-duct installation.

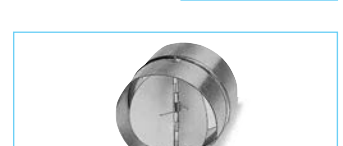

■ Accessories for all types

Back draught shutter

Type RSKK 125 Ref. no. 5107

Automatic, made of polymer. For in-duct installation.



Operating switch 0-1-2

Type MVB Ref. no. 6091

With on/off, low and high speed functions.



Transformer speed controller

Type TSW see table

Five-step, for surface mounting.



Electronic speed controller

Type ESU/ESA see table

For flush-/surface mounting.



Electronic run-on switch

Type ZNE Ref. no. 0342

With continuously adjustable follow-up time.

High air flow volume and high pressure characteristic in a space saving design.

Specifically made for in-duct installation. Versatile for use in most commercial, industrial and domestic applications.

Special features

- Less space required and simple site installation of the compact in line design.
- Its simplicity reduces site costs.
- Supply and exhaust air spigots fit all standard circular duct sizes.
- Two speeds, as standard; plus fully controllable motor speed
- Installation in any position.
- Long life ball bearings, designed for 30.000 operating hours.
- Trouble-free maintenance and cleaning by removing the core of the unit from its frame without disassembling the ducting.
- Fan unit with terminal box can be rotated to any position.
- Integral mounting bracket for easy installation on floor, wall and ceiling.

Common features

- Casing**
By loosening the clips the fan section can be removed from the casing leaving the mounting bracket. All components are manufactured from impact resistant and corrosion resistant polymer. Colour: Light grey.
- Speed control**
Standard two-speed control with external operating switch MVB (accessory). Full speed control with an electronic controller or five-step transformer.
- Motor**
Totally enclosed ball bearing motor made for continuous operation with insulation class F and moisture protection. Maintenance-free and interference-free.
- Motor protection**
Thermal overload protection fitted in the winding as standard.

MV – Single-stage

Swing-out in-line fan for space-saving installation in ducting.

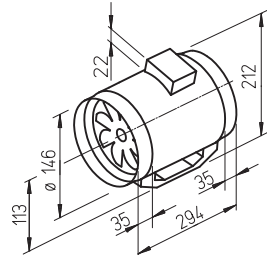

Dim. in mm

Specification MV

- Impeller**
Optimised for high pressure and volumetric performance, made from high grade polymer.
- Electrical connection**
The spacious terminal box (IP 44) is mounted on the casing; rotatable to any position.
- Installation**
Can be mounted in any position – horizontal, vertical or diagonal – suitable for supply and extract ventilation by correct installation. To minimise the effective noise level it is recommended that the fan is installed as remote as possible from the ventilated space.

MVZ – Two-stage

For higher pressure performance: Two in-line fans mounted in series.

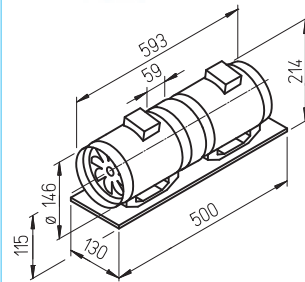

Dim. in mm

Specification MVZ

- Impeller**
Two MV fans are connected in series using a connecting sleeve and assembled on a common base plate. Delivered as ready-to-assemble kits. Series operation doubles the pressure output at the same volume.
- Impeller**
As described on the left.
- Electrical connection**
Each fan has a separate terminal box on the outer casing. By operating the two fans on two speeds using one operation switch MVB (accessory) or one change-over switch (on site) a coupling relay has to be used as shown in the wiring diagram. When using a speed controller, the high speed amps have to be allowed for.
- Installation**
Can be mounted in any position – horizontal, vertical or diagonal – suitable for supply and extract ventilation by correct installation. To minimise the effective noise level it is recommended that the fan is installed as remote as possible from the ventilated space.

MVP – Parallel

For higher volume output in a compact parallel design.

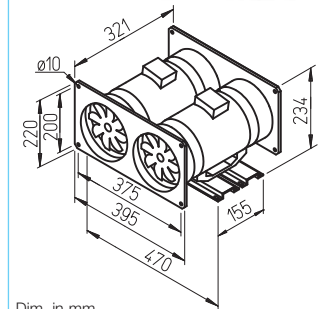

Dim. in mm

Specification MVP

- Impeller**
The two parallel MV fans are mounted on common mounting rails and have a connector plate fitted to both the intake and exhaust. Delivered as ready-to-assemble kits. Parallel operation (both fans running) doubles the air volume at the same pressure.
- Impeller**
As described on the left.
- Speed control / Connection**
Each fan is located with a separate terminal box on the outer casing. By operating the two fans on two speeds using one operation switch MVB (accessory) or one change-over switch (on site) a pair of relays have to be used as shown in the wiring diagram. When using a speed controller, the high speed amps have to be allowed for. Each fan can also be operated separately or together when necessary. To prevent the recirculation, two exhaust back draught shutters are required (RSK, accessory).

Type	Ref. no.	Connection Ø	Air flow volume min./max.	R.P.M. min./max.	Sound pressure level in 1 m case breakout		Power consumption min./max.	Current min./max.	Wiring diagram	Max. air flow temperature	Weight net approx.	Transformer-speed controller 5-step		Electronic* speed controller, stepless flush/surface	
					dB (A)	dB (A)						Type	Ref. no.	Type	Ref. no.
			mm	V m³/h	min ⁻¹		W	A	No.	+ °C	kg	Type	Ref. no.	Type	Ref. no.
Single-stage in-line fan, 230 V, 50 Hz, capacitor motor, IP 44															
MV 150	6053	150	380/520	1520/2290	40/48	56/64	40/58	0.18/0.26	844.1	60	2.3	TSW 0,3	3608	ESU 1/ESA 1	0236/0238
Two-stage in-line fan, 230 V, 50 Hz, capacitor motor, IP 44															
MVZ 150	6060	150	380/520	1520/2290	46/54	59/67	80/116	0.36/0.52	845.1	60	5.8	TSW 1,5	1495	ESU 1/ESA 1	0236/0238
Parallel-twin-unit, 230 V, 50 Hz, capacitor motor, IP 44															
MVP 150	6067	—	760/1040	1520/2290	43/51	59/67	80/116	0.36/0.52	845.1	60	8.0	TSW 1,5	1495	ESU 1/ESA 1	0236/0238

* In noise sensitive cases, transformer-control devices should be used. Electronic phase angle control may generate disturbing increase in motor noise.

MV 150 – Single-stage

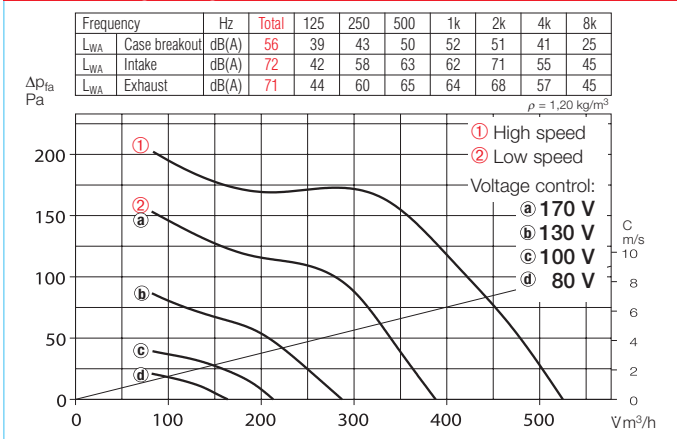

MVZ 150 – Two-stage

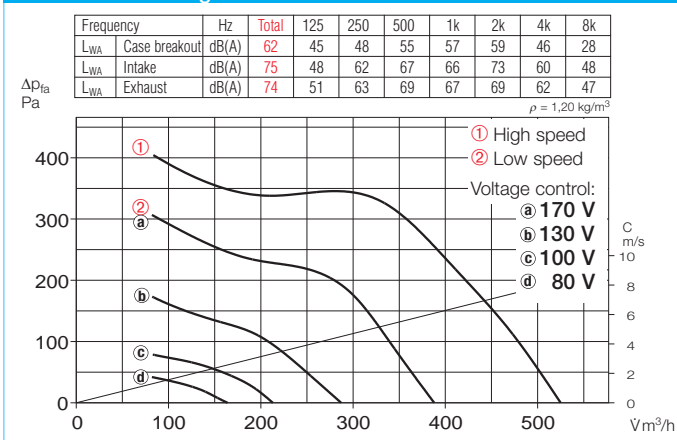

MVP 150 – Parallel

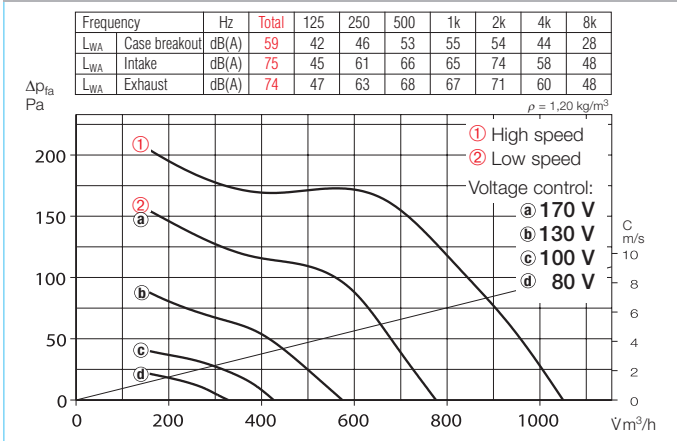

Sound levels

The total values and the spectrum figures are given above the performance curves for

- Sound level case breakout
- Sound level intake and exhaust air in dB(A)

On the table (see left page)

- The case breakout figures and the intake/exhaust air noise levels are additionally given as sound pressure level at 1 m (free-field conditions).

The Helios figures have to be reduced by 8 dB(A) if compared to sound pressure levels at 3 m.

Accessory details Page

Filters, heater batteries and attenuators	421 on
Temperature controllers for heater batteries	427, 431
Flexible ventilation ducting, grilles, adaptors, roof terminations	487 on
Poppet valves	508 on
Speed controllers and switches	525 on

Accessories for MV and MVZ

Flexible connector

Type FM 150 Ref. no. 1683
Supplied with two hose clips as standard; for installation between fan and duct system. Prevents sound and vibration transmission and compensates small misalignments on site. Two sleeves are needed for intake and exhaust operation.



Gravity shutter

Type VK 160 Ref. no. 0892
Wall mounted, automatic pressure control shutter for the air outlet. Made of white polymer.



External wall grille

Type G 160 Ref. no. 0893
To cover or insert into circular ventilation holes. Made of impact resistant, white polymer.



Guard

Type MVS 150 Ref. no. 6073
For intake and exhaust installation on the ventilation unit.



Spigotted attenuator

Type FSD 160¹⁾ Ref. no. 0678
Made from aluminium with plug sockets on both sides. With 50 mm insulation, length 1 m.



Air filter box

LFBR 160 G4¹⁾ Ref. no. 8578
With a large cross section area, for in-duct installation.



Electric heater batteries

EHR-R 1,2/160¹⁾ 1,2 kW No. 9434
In circular casing, made of galvanised steel.

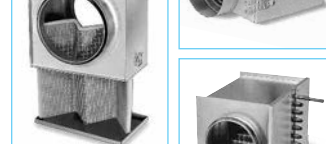

Warm-water heater batteries

Type WHR 160¹⁾ Ref. no. 9481
For in-duct installation.

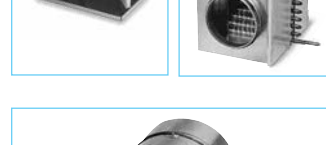

Accessories for all types

Back draught shutter

Type RSK 150 Ref. no. 5073
Automatic, made of metal. For in-duct installation.



Operating switch 0-1-2

Type MVB Ref. no. 6091
With on/off, low and high speed functions.



Transformer speed controller

Type TSW see table
Five-step, for surface mounting.



Electronic speed controller

Type ESU/ESA see table
For flush-/surface mounting.



Electronic run-on switch

Type ZNE Ref. no. 0342
With continuously adjustable follow-up time.



¹⁾ This accessory with ND 160 mm is applicable for ø 150 mm ducting by use of foam rubber.

High air flow volume and high pressure characteristic in a space saving design.
Specifically made for in-duct installation. Versatile for use in most commercial, industrial and domestic applications.

Special features

- Less space required and simple site installation of the compact in line design.
- Its simplicity reduces site costs.
- Supply and exhaust air spigots fit all standard circular duct sizes.
- Two speeds, as standard; plus fully controllable motor speed
- Installation in any position.
- Long life ball bearings, designed for 30.000 operating hours.
- Trouble-free maintenance and cleaning by removing the core of the unit from its frame without disassembling the ducting.
- Fan unit with terminal box can be rotated to any position.
- Integral mounting bracket for easy installation on floor, wall and ceiling.

Common features

- Casing**
By loosening the clips the fan section can be removed from the casing leaving the mounting bracket. All components are manufactured from impact resistant and corrosion resistant polymer. Colour: Light grey.
- Speed control**
Standard two-speed control with external operating switch MVB (accessory). Full speed control with an electronic controller or five-step transformer.
- Motor**
Totally enclosed ball bearing motor made for continuous operation with insulation class F and moisture protection. Maintenance-free and interference-free.
- Motor protection**
Thermal overload protection fitted in the winding as standard.

MV – Single-stage

Swing-out in-line fan for space-saving installation in ducting.

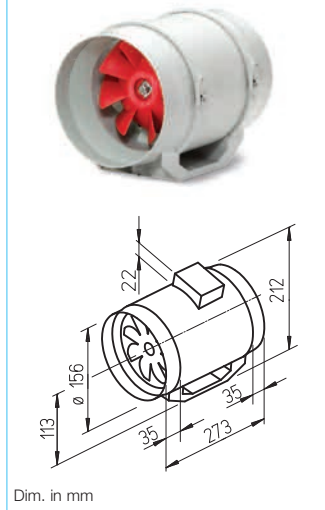

Specification MV

- Impeller**
Optimised for high pressure and volumetric performance, made from high grade polymer.
- Electrical connection**
The spacious terminal box (IP 44) is mounted on the casing; rotatable to any position.
- Installation**
Can be mounted in any position – horizontal, vertical or diagonal – suitable for supply and extract ventilation by correct installation. To minimise the effective noise level it is recommended that the fan is installed as remote as possible from the ventilated space.

MVZ – Two-stage

For higher pressure performance: Two in-line fans mounted in series.

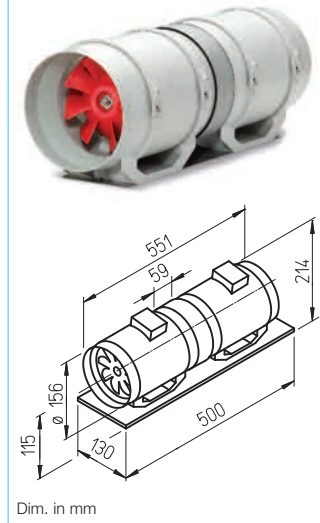

Specification MVZ

- Impeller**
Two MV fans are connected in series using a connecting sleeve and assembled on a common base plate. Delivered as ready-to-assemble kits. Series operation doubles the pressure output at the same volume.
- Impeller**
As described on the left.
- Electrical connection**
Each fan has a separate terminal box on the outer casing. By operating the two fans on two speeds using one operation switch MVB (accessory) or one change-over switch (on site) a coupling relay has to be used as shown in the wiring diagram. When using a speed controller, the high speed amps have to be allowed for.
- Installation**
Can be mounted in any position – horizontal, vertical or diagonal – suitable for supply and extract ventilation by correct installation. To minimise the effective noise level it is recommended that the fan is installed as remote as possible from the ventilated space.

MVP – Parallel

For higher volume output in a compact parallel design.

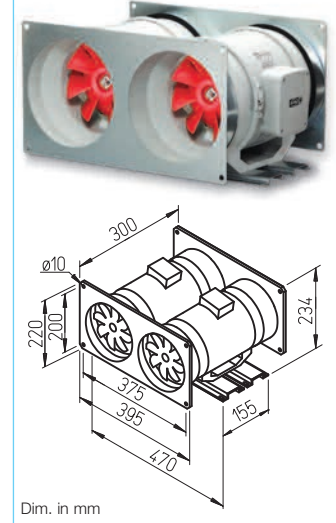

Specification MVP

- Impeller**
The two parallel MV fans are mounted on common mounting rails and have a connector plate fitted to both the intake and exhaust. Delivered as ready-to-assemble kits. Parallel operation (both fans running) doubles the air volume at the same pressure.
- Impeller**
As described on the left.
- Speed control / Connection**
Each fan is located with a separate terminal box on the outer casing. By operating the two fans on two speeds using one operation switch MVB (accessory) or one change-over switch (on site) a pair of relays have to be used as shown in the wiring diagram. When using a speed controller, the high speed amps have to be allowed for. Each fan can also be operated separately or together when necessary. To prevent the recirculation, two exhaust back draught shutters are required (RSK, accessory).

Type	Ref. no.	Connection Ø	Air flow volume min./max.	R.P.M. min./max.	Sound pressure level in 1 m case breakout		Power consumption min./max.	Current min./max.	Wiring diagram	Max. air flow temperature	Weight net approx.	Transformer-speed controller 5-step		Electronic* speed controller, stepless flush/surface	
					dB (A)	dB (A)						Type	Ref. no.	Type	Ref. no.
Single-stage in-line fan, 230 V, 50 Hz, capacitor motor, IP 44															
MV 160	6054	160	390/550	1520/2290	41/49	57/65	40/58	0.18/0.26	844.1	60	2.3	TSW 0,3	3608	ESU 1/ESA 1	0236/0238
Two-stage in-line fan, 230 V, 50 Hz, capacitor motor, IP 44															
MVZ 160	6061	160	390/550	1520/2290	47/55	59/67	80/116	0.36/0.52	845.1	60	5.8	TSW 1,5	1495	ESU 1/ESA 1	0236/0238
Parallel-twin-unit, 230 V, 50 Hz, capacitor motor, IP 44															
MVP 160	6068	—	780/1100	1520/2290	44/52	60/68	80/116	0.36/0.52	845.1	60	7.7	TSW 1,5	1495	ESU 1/ESA 1	0236/0238

* In noise sensitive cases, transformer-control devices should be used. Electronic phase angle control may generate disturbing increase in motor noise.

MV 160 – Single-stage

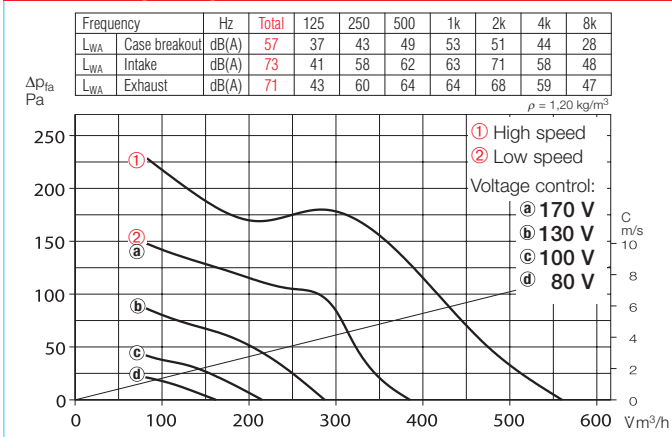

MVZ 160 – Two-stage

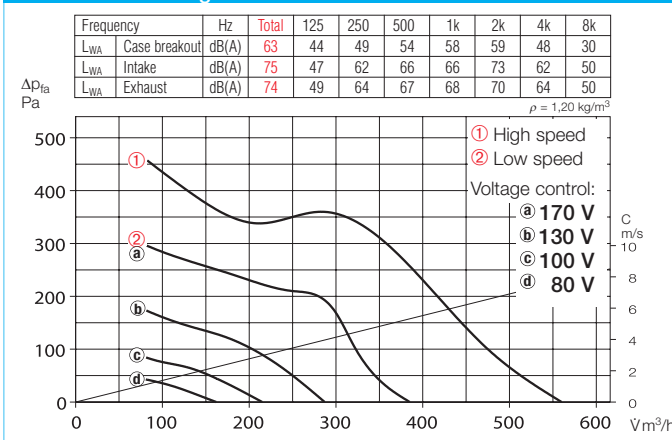

MVP 160 – Parallel

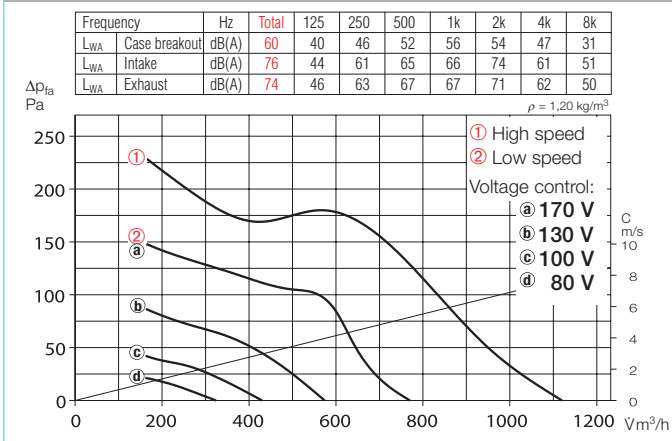

Sound levels

The total values and the spectrum figures are given above the performance curves for

- Sound level case breakout
- Sound level intake and exhaust air in dB(A)
- On the table (see left page)
- The case breakout figures and the intake/exhaust air noise levels are additionally given as sound pressure level at 1 m (free-field conditions).

The Helios figures have to be reduced by 8 dB(A) if compared to sound pressure levels at 3 m.

Accessory details Page

Filters, heater batteries and attenuators	421 on
Temperature controllers for heater batteries	427, 431
Flexible ventilation ducting, grilles, adaptors, roof terminations	487 on
Poppet valves	508 on
Speed controllers and switches	525 on

Accessories for MV and MVZ

Flexible connector

Type FM 160 Ref. no. 1684
Supplied with two hose clips as standard; for installation between fan and duct system. Prevents sound and vibration transmission and compensates small misalignments on site. Two sleeves are needed for intake and exhaust operation.



Gravity shutter

Type VK 160 Ref. no. 0892
Wall mounted, automatic pressure control shutter for the air outlet. Made of white polymer.



External wall grille

Type G 160 Ref. no. 0893
To cover or insert into circular ventilation holes. Made of impact resistant, white polymer.



Guard

Type MVS 160 Ref. no. 6074
For intake and exhaust installation on the ventilation unit.



Spigotted attenuator

Type FSD 160 Ref. no. 0678
Made from aluminium with plug sockets on both sides. With 50 mm insulation, length 1 m.



Air filter box

LFBR 160 G4 Ref. no. 8578
With a large cross section area, for in-duct installation.



Electric heater batteries

EHR-R 1,2/160 1,2 kW No. 9434
In circular casing, made of galvanised steel.

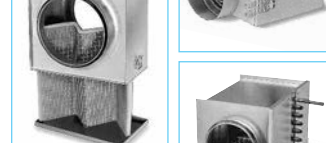

Warm-water heater batteries

Type WHR 160 Ref. no. 9481
For in-duct installation.



Accessories for all types

Back draught shutter

Type RSK 160 Ref. no. 5669
Automatic, made of metal. For in-duct installation.



Operating switch 0-1-2

Type MVB Ref. no. 6091
With on/off, low and high speed functions.



Transformer speed controller

Type TSW see table
Five-step, for surface mounting.



Electronic speed controller

Type ESU/ESA see table
For flush-/surface mounting.



Electronic run-on switch

Type ZNE Ref. no. 0342
With continuously adjustable follow-up time.



High air flow volume and high pressure characteristic in a space saving design.
Specifically made for in-duct installation. Versatile for use in most commercial, industrial and domestic applications.

Special features

- Less space required and simple site installation of the compact in line design.
- Its simplicity reduces site costs.
- Supply and exhaust air spigots fit all standard circular duct sizes.
- Two speeds, as standard; plus fully controllable motor speed
- Installation in any position.
- Long life ball bearings, designed for 30.000 operating hours.
- Trouble-free maintenance and cleaning by removing the core of the unit from its frame without disassembling the ducting.
- Fan unit with terminal box can be rotated to any position.
- Integral mounting bracket for easy installation on floor, wall and ceiling.

Common features

- Casing**
By loosening the clips the fan section can be removed from the casing leaving the mounting bracket. All components are manufactured from impact resistant and corrosion resistant polymer. Colour: Light grey.
- Speed control**
Standard two-speed control with external operating switch MVB (accessory). Full speed control with an electronic controller or five-step transformer.
- Motor**
Totally enclosed ball bearing motor made for continuous operation with insulation class F and moisture protection. Maintenance-free and interference-free.
- Motor protection**
Thermal overload protection fitted in the winding as standard.

MV – Single-stage

Swing-out in-line fan for space-saving installation in ducting.

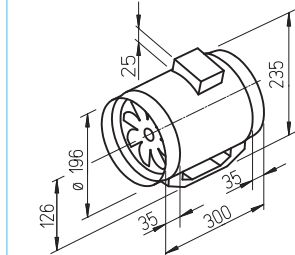

Dim. in mm

Specification MV

- Impeller**
Optimised for high pressure and volumetric performance, made from high grade polymer.
- Electrical connection**
The spacious terminal box (IP 44) is mounted on the casing; rotatable to any position.
- Installation**
Can be mounted in any position – horizontal, vertical or diagonal – suitable for supply and extract ventilation by correct installation. To minimise the effective noise level it is recommended that the fan is installed as remote as possible from the ventilated space.

MVZ – Two-stage

For higher pressure performance: Two in-line fans mounted in series.

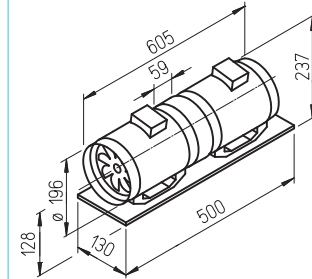

Dim. in mm

Specification MVZ

- Impeller**
Two MV fans are connected in series using a connecting sleeve and assembled on a common base plate. Delivered as ready-to-assemble kits. Series operation doubles the pressure output at the same volume.
- Impeller**
As described on the left.
- Electrical connection**
Each fan has a separate terminal box on the outer casing. By operating the two fans on two speeds using one operation switch MVB (accessory) or one change-over switch (on site) a coupling relay has to be used as shown in the wiring diagram. When using a speed controller, the high speed amps have to be allowed for.
- Installation**
Can be mounted in any position – horizontal, vertical or diagonal – suitable for supply and extract ventilation by correct installation. To minimise the effective noise level it is recommended that the fan is installed as remote as possible from the ventilated space.

MVP – Parallel

For higher volume output in a compact parallel design.

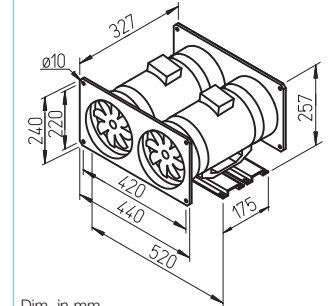

Dim. in mm

Specification MVP

- Impeller**
The two parallel MV fans are mounted on common mounting rails and have a connector plate fitted to both the intake and exhaust. Delivered as ready-to-assemble kits. Parallel operation (both fans running) doubles the air volume at the same pressure.
- Impeller**
As described on the left.
- Speed control / Connection**
Each fan is located with a separate terminal box on the outer casing. By operating the two fans on two speeds using one operation switch MVB (accessory) or one change-over switch (on site) a pair of relays have to be used as shown in the wiring diagram. When using a speed controller, the high speed amps have to be allowed for. Each fan can also be operated separately or together when necessary. To prevent the recirculation, two exhaust back draught shutters are required (RSK, accessory).

Type	Ref. no.	Connection Ø	Air flow volume min./max.	R.P.M. min./max.	Sound pressure level in 1 m case breakout		Power consumption min./max.	Current min./max.	Wiring diagram	Max. air flow temperature	Weight net approx.	Transformer-speed controller 5-step		Electronic* speed controller, stepless flush/surface	
					dB (A)	dB (A)						Type	Ref. no.	Type	Ref. no.
Single-stage in-line fan, 230 V, 50 Hz, capacitor motor, IP 44															
MV 200	6055	200	680/930	1780/2740	36/44	50/58	45/75	0.22/0.37	844.1	60	3.7	TSW 1,5	1495	ESU 1/ESA 1	0236/0238
Two-stage in-line fan, 230 V, 50 Hz, capacitor motor, IP 44															
MVZ 200	6062	200	755/900	1780/2740	44/51	55/62	90/150	0.44/0.74	845.1	60	8.5	TSW 1,5	1495	ESU 1/ESA 1	0236/0238
Parallel-twin-unit, 230 V, 50 Hz, capacitor motor, IP 44															
MVP 200	6069	—	1360/1860	1780/2740	39/47	53/61	90/150	0.44/0.74	845.1	60	11.2	TSW 1,5	1495	ESU 1/ESA 1	0236/0238

* In noise sensitive cases, transformer-control devices should be used. Electronic phase angle control may generate disturbing increase in motor noise.

MV 200 – Single-stage

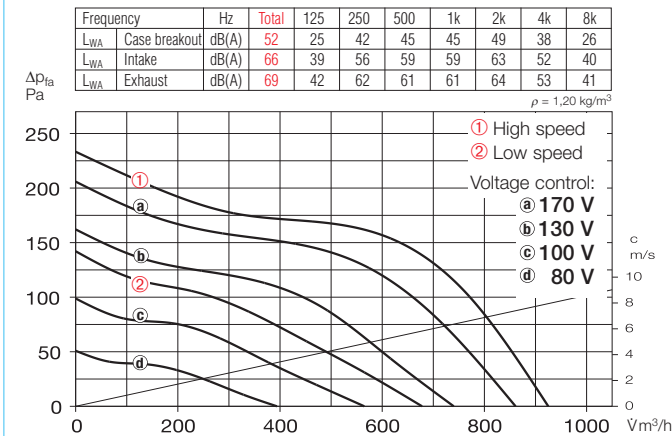

MVZ 200 – Two-stage

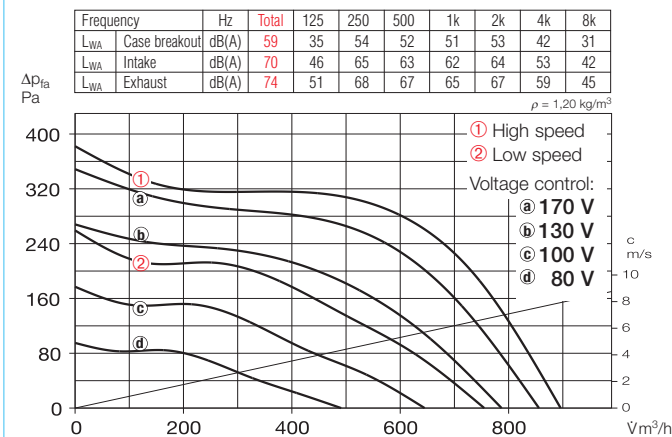

MVP 200 – Parallel

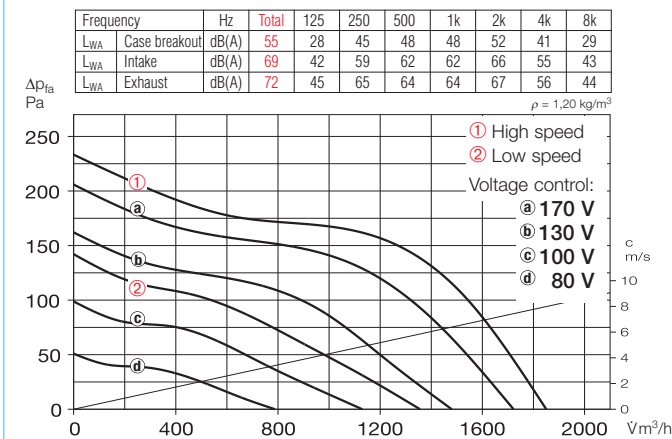

■ Sound levels

The total values and the spectrum figures are given above the performance curves for

- Sound level case breakout
- Sound level intake and exhaust air in dB(A)
- On the table (see left page)
- The case breakout figures and the intake/exhaust air noise levels are additionally given as sound pressure level at 1 m (free-field conditions).

The Helios figures have to be reduced by 8 dB(A) if compared to sound pressure levels at 3 m.

■ Accessory details Page

Filters, heater batteries and attenuators	421 on
Temperature controllers for heater batteries	427, 431
Flexible ventilation ducting, grilles, adaptors, roof terminations	487 on
Poppet valves	508 on
Speed controllers and switches	525 on

■ Accessories for MV and MVZ

Flexible connector

Type FM 200 Ref. no. 1670
Supplied with two hose clips as standard; for installation between fan and duct system. Prevents sound and vibration transmission and compensates small misalignments on site. Two sleeves are needed for intake and exhaust operation.



Gravity shutter

Type VK 200 Ref. no. 0758
Wall mounted, automatic pressure control shutter for the air outlet. Made of polymer. Colour: Light grey.



External wall grille

Type RAG 200 Ref. no. 0750
To position in front of air inlets and outlets in facades. Made of polymer; colour: Light grey.



Guard

Type MVS 200 Ref. no. 6075
For intake and exhaust installation on the ventilation unit.



Spigotted attenuator

Type FSD 200 Ref. no. 0679
Made from aluminium with plug sockets on both sides. With 50 mm insulation, length 1 m.



Air filter box

LFBR 200 G4 Ref. no. 8579
With a large cross section area, for in-duct installation.



Electric heater batteries

EHR-R 1,2/200 1,2 kW No. 9436
In circular casing, made of galvanised steel.

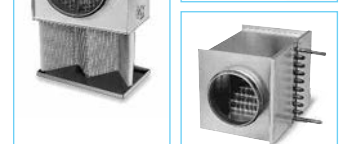

Warm-water heater batteries

Type WHR 200 Ref. no. 9482
For in-duct installation.



■ Accessories for all types

Back draught shutter

Type RSK 200 Ref. no. 5074
Automatic, made of metal. For in-duct installation.



Operating switch 0-1-2

Type MVB Ref. no. 6091
With on/off, low and high speed functions.



Transformer speed controller

Type TSW see table
Five-step, for surface mounting.



Electronic speed controller

Type ESU/ESA see table



Electronic run-on switch – for MV

Type ZNE Ref. no. 0342

– for MVZ and MVP

Type ZT Ref. no. 1277



High air flow volume and high pressure characteristic in a space saving design.
Specifically made for in-duct installation. Versatile for use in most commercial, industrial and domestic applications.

Special features

- Less space required and simple site installation of the compact in line design.
- Its simplicity reduces site costs.
- Supply and exhaust air spigots fit all standard circular duct sizes.
- Two speeds, as standard; plus fully controllable motor speed
- Installation in any position.
- Long life ball bearings, designed for 30.000 operating hours.
- Trouble-free maintenance and cleaning by removing the core of the unit from its frame without disassembling the ducting.
- Fan unit with terminal box can be rotated to any position.
- Integral mounting bracket for easy installation on floor, wall and ceiling.

Common features

- Casing**
By loosening the clips the fan section can be removed from the casing leaving the mounting bracket. All components are manufactured from impact resistant and corrosion resistant polymer. Colour: Light grey.
- Speed control**
Standard two-speed control with external operating switch MVB (accessory). Full speed control with an electronic controller or five-step transformer.
- Motor**
Totally enclosed ball bearing motor made for continuous operation with insulation class F and moisture protection. Maintenance-free and interference-free.
- Motor protection**
Through a thermal contact that is connected in series with the winding and Turns the motor off at elevated temperatures to prevent motor damage. Resets after cooling and motor restart.

MV – Single-stage

Swing-out in-line fan for space-saving installation in ducting.

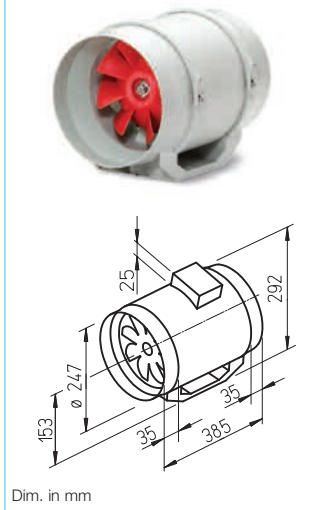

Specification MV

- Impeller**
Optimised for high pressure and volumetric performance, made from high grade polymer.
- Electrical connection**
The spacious terminal box (IP 44) is mounted on the casing; rotatable to any position.
- Installation**
Can be mounted in any position – horizontal, vertical or diagonal – suitable for supply and extract ventilation by correct installation. To minimise the effective noise level it is recommended that the fan is installed as remote as possible from the ventilated space.

MVZ – Two-stage

For higher pressure performance: Two in-line fans mounted in series.

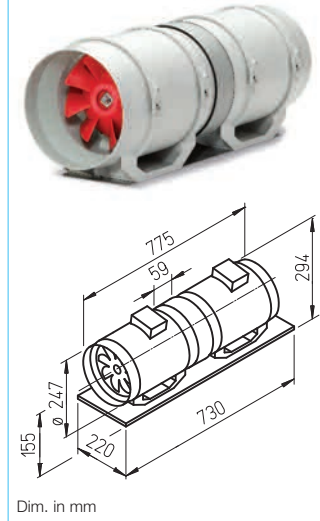

Specification MVZ

- Impeller**
Two MV fans are connected in series using a connecting sleeve and assembled on a common base plate. Delivered as ready-to-assemble kits. Series operation doubles the pressure output at the same volume.
- Impeller**
As described on the left.
- Electrical connection**
Each fan has a separate terminal box on the outer casing. By operating the two fans on two speeds using one operation switch MVB (accessory) or one change-over switch (on site) a coupling relay has to be used as shown in the wiring diagram. When using a speed controller, the high speed amps have to be allowed for.
- Installation**
Can be mounted in any position – horizontal, vertical or diagonal – suitable for supply and extract ventilation by correct installation. To minimise the effective noise level it is recommended that the fan is installed as remote as possible from the ventilated space.

MVP – Parallel

For higher volume output in a compact parallel design.

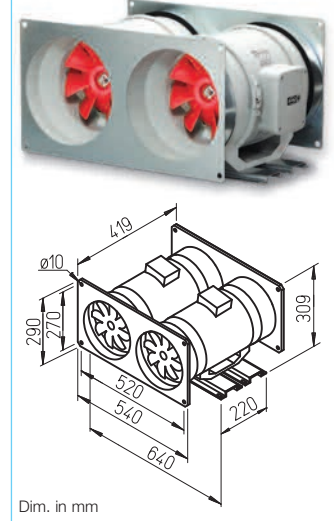

Specification MVP

- Impeller**
The two parallel MV fans are mounted on common mounting rails and have a connector plate fitted to both the intake and exhaust. Delivered as ready-to-assemble kits. Parallel operation (both fans running) doubles the air volume at the same pressure.
- Impeller**
As described on the left.
- Speed control / Connection**
Each fan is located with a separate terminal box on the outer casing. By operating the two fans on two speeds using one operation switch MVB (accessory) or one change-over switch (on site) a pair of relays have to be used as shown in the wiring diagram. When using a speed controller, the high speed amps have to be allowed for. Each fan can also be operated separately or together when necessary. To prevent the recirculation, two exhaust back draught shutters are required (RSK, accessory).

Type	Ref. no.	Connection Ø	Air flow volume min./max.	R.P.M. min./max.	Sound pressure level in 1 m case breakout	air noise min./max.	Power consumption min./max.	Current min./max.	Wiring diagram	Max. air flow temperature	Weight net approx.	Transformer-speed controller 5-step	Electronic* speed controller, stepless flush/surface		
		mm	∇ m³/h	min⁻¹	dB (A)	dB (A)	W	A	No.	+ °C	kg	Type	Ref. no.	Type	Ref. no.
Single-stage in-line fan, 230 V, 50 Hz, capacitor motor, IP 44															
MV 250	6056	250	680/910	1850/2550	40/52	53/66	85/110	0.40/0.50	844.1	60	7.0	TSW 1,5	1495	ESU 1/ESA 1	0236/0238
Two-stage in-line fan, 230 V, 50 Hz, capacitor motor, IP 44															
MVZ 250	6063	250	710/900	1850/2550	46/56	57/67	170/220	0.80/1.00	845.1	60	17.6	TSW 1,5	1495	ESU 3/ESA 3	0237/0239
Parallel-twin-unit, 230 V, 50 Hz, capacitor motor, IP 44															
MVP 250	6070	—	1280/1820	1850/2550	43/55	56/69	170/220	0.80/1.00	845.1	60	18.7	TSW 1,5	1495	ESU 3/ESA 3	0237/0239

* In noise sensitive cases, transformer-control devices should be used. Electronic phase angle control may generate disturbing increase in motor noise.

MV 250 – Single-stage

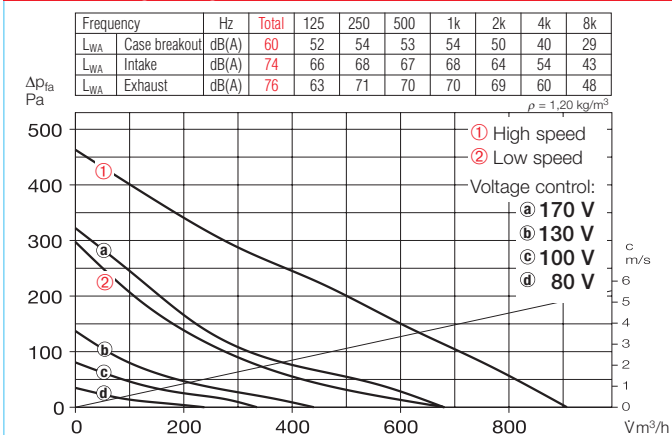

MVZ 250 – Two-stage

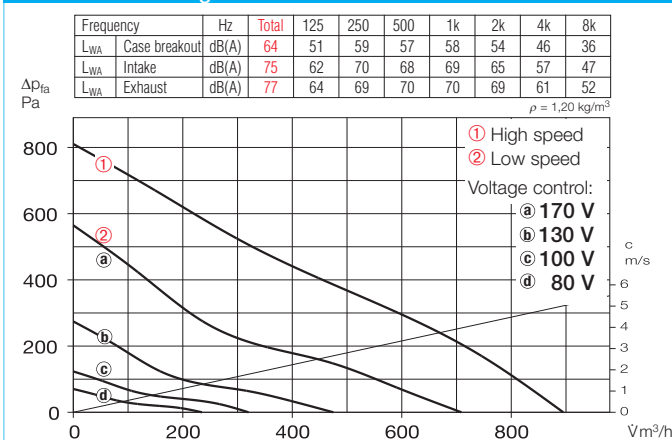

MVP 250 – Parallel

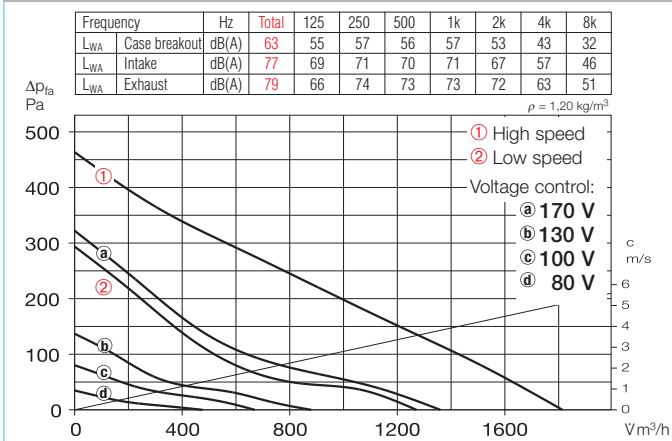

■ Sound levels

The total values and the spectrum figures are given above the performance curves for

- Sound level case breakout
- Sound level intake and exhaust air in dB(A)
- On the table (see left page)
- The case breakout figures and the intake/exhaust air noise levels are additionally given as sound pressure level at 1 m (free-field conditions).

The Helios figures have to be reduced by 8 dB(A) if compared to sound pressure levels at 3 m.

■ Accessory details Page

Filters, heater batteries and attenuators	421 on
Temperature controllers for heater batteries	427, 431
Flexible ventilation ducting, grilles, adaptors, roof terminations	487 on
Poppet valves	508 on
Speed controllers and switches	525 on

■ Accessories for MV and MVZ

Flexible connector

Type FM 250 Ref. no. 1672
Supplied with two hose clips as standard; for installation between fan and duct system. Prevents sound and vibration transmission and compensates small misalignments on site. Two sleeves are needed for intake and exhaust operation.



Gravity shutter

Type VK 250 Ref. no. 0759
Wall mounted, automatic pressure control shutter for the air outlet. Made of polymer. Colour: Light grey.



External wall grille

Type RAG 250 Ref. no. 0751
To position in front of air inlets and outlets in facades. Made of polymer; colour: Light grey.



Guard

Type MVS 250 Ref. no. 6076
For intake and exhaust installation on the ventilation unit.



Spigotted attenuator

Type FSD 250 Ref. no. 0680
Made from aluminium with plug sockets on both sides. With 50 mm insulation, length 1 m.



Air filter box

LFBR 250 G4 Ref. no. 8580
With a large cross section area, for in-duct installation.



Electric heater batteries

EHR-R 6/250 6,0 kW No. 8712
In circular casing, made of galvanised steel.

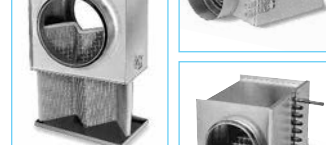

Warm-water heater batteries

Type WHR 250 Ref. no. 9483
For in-duct installation.



■ Accessories for all types

Back draught shutter

Type RSK 250 Ref. no. 5673
Automatic, made of metal. For in-duct installation.



Operating switch 0-1-2

Type MVB Ref. no. 6091
With on/off, low and high speed functions.



Transformer speed controller

Type TSW see table
Five-step, for surface mounting.



Electronic speed controller

Type ESU/ESA see table
For flush-/surface mounting.



Thermoelectr. run-on switch

Type ZT Ref. no. 1277
With variable run-on time.



In-line fans with explosion protection according to Directive 2014/34/EU (ATEX).



The requirements for equipment and operating materials which may pose a risk of ignition are standardised across Europe and stated in the Directive 2014/34/EU (ATEX). These contain the fundamental health and safety requirements for products with explosion protection and describe the conformity evaluation process for appliances used in potentially explosive atmospheres.

The small RRK Ex fans from Helios are suitable for operation in potentially explosive atmospheres and for conveying potentially explosive mixtures of gas, steam and air and satisfy the requirements of Directive 2014/34/EU (ATEX). They are in ignition protection category "e" (= increased safety) and therefore comply with equipment group II, category 2G for operation in zone 1 and 2. In these areas, hazardous, potentially explosive atmospheres arise occasionally or rarely and briefly.

When installed properly, RRK Ex appliances fulfill all fundamental health and safety requirements.

RRK Ex appliances are suitable for carrying small air flow volumes for ventilating areas in commercial and industrial applications.
Ø 180 – 250 mm
 $\dot{V} = 290 - 970 \text{ m}^3/\text{h}$



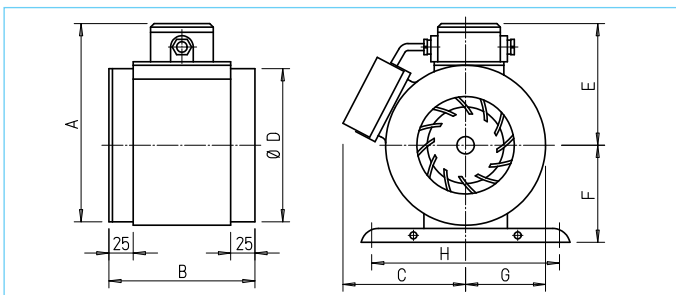

Type	RRK 180 Ex	200 Ex	250 Ex
A	231	278	304
B	164	267	205
C	160	195	210
D	Ø 178	Ø 198 ¹⁾	Ø 248
E	142	166	180
F	120	140	160
G	92	115	128
H	275	299	311

All dimensions in mm
¹⁾ with reducers mounted on intake and exhaust

Designed to ventilate rooms and working places in commercial and industrial applications where a hazardous atmosphere can occur. Suitable for in-line duct installation.

Approved for installation in zones 1 and 2 to DIN EN 60079-10. Specially designed for ventilating chemical and pharmaceutical laboratories, warehouses, dye works, battery rooms etc.

Ex Ex e II 2G

Special features

- EC-Type Examination Certificate according to Directive 2014/34/EU (ATEX) .
- Explosion proof E Exe II 2G, increased safety to DIN EN 60079-0, 60079-7, 1127-1, 14986.
- Single phase 230 V, 50 Hz.
- Ideally to be installed in-line with ducting. Three performances for model RRK 180 Ex by use of reducers (see perf. curve).
- Very compact in design and low installation cost through straight air flow.
- Installation in any position.

Specification

- **Casing and impeller**
Made from impact resistant, anti-static polymers offering an electrical resistance of less than $10^9 \Omega$.
- **Motor** Totally enclosed, IP 54, suitable for continuous operation. Maintenance free ball bearing motor with tropical protection of windings and interference-free.
- **Electrical connection** terminal box made from polymer, IP 54, ex-proofed, mounted on the fan casing.
- **Installation** in any position. Suitable for intake and extract.

Installation notes

The regulations of DIN EN 60079-10 apply. The motor must be protected by a circuit breaker which isolates the equipment in case of a short circuit within the time shown on the explosion proof certificate. The inlet and exhaust must be protected by guards or other devices to prevent items bigger than 12 mm from entering the fan. Admitted operation mode according to VDE 0530 / DIN EN 60034-1 = S1 (continuous operation). Speed control is not allowed.

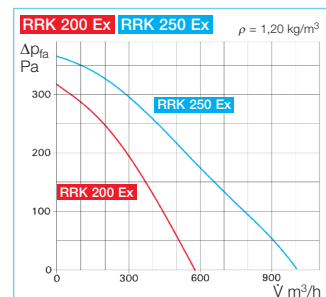
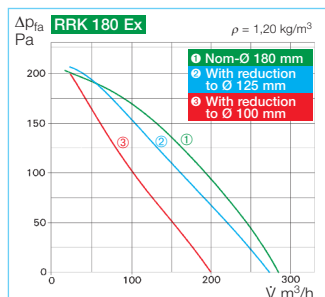

Accessories for RRK 180 Ex Reducers

- Type RZ 180/125 Ref. no. 5876
- Type RZ 180/100 Ref. no. 5877

Accessory for all models Mounting feet

- Type MK 4 Ref. no. 5824

Flexible sleeve

For installation between fan and ducting.

- Type FM 180 Ex Ref. no. 1685
- Type FM 200 Ex Ref. no. 1686
- Type FM 250 Ex Ref. no. 1688

Guard

- Type SGR 180 Ex Ref. no. 5051
- Type SGR 200 Ex Ref. no. 5049
- Type SGR 250 Ex Ref. no. 5052

Backdraught shutter

- Type RSK 180 Ref. no. 5662
- Type RSK 200 Ref. no. 5074
- Type RSK 250 Ref. no. 5673



Other accessories Page

Filters and attenuators	421 on
Flexible ventilation ducts, grilles, adaptors and roof terminations	487 on
Poppet valves	508 on

Note Page

Explosion protection	
- Zone allocation	14
- Danger areas	16

Type	Ref. no.	Impeller Ø	Air flow volume (FID)	Nominal R.P.M.	Sound power level L _{WA}	Sound press. level 1 m	Power consumption	Current	Wiring diagram	Maximum air flow temperature	Weight net approx.
		mm	V m ³ /h	min ⁻¹	dB (A)	dB (A)	W	A	No.	+ °C	kg
Explosion proof Ex e II, 1 phase motor, 230 V, 50 Hz, capacitor motor, protection to IP 54											
RRK 180 Ex ¹⁾	5889	170	290	2780	66	58	50	0.25	453	50	3.0
RRK 200 Ex ²⁾	5890	215	560	2860	64	65	200	0.92	453	50	5.5
RRK 250 Ex ²⁾	5891	240	970	2860	77	69	300	1.40	453	50	7.0

¹⁾ Temperature class T1-T4

²⁾ Temperature class T1-T3

Robust, ultra-flat centrifugal in-line fans.

HELIOS INLINEVENT®



InlineVent® in-line fans from Helios combine the performance characteristics of centrifugal fans with the benefits of the axial design. The straight-line flow progression enables direct placement in the middle of the ducting systems and simple, cost-effective installation.

HELIOS SLIMVENT



SlimVent centrifugal fans are ideal when there is little installation space in residential, commercial and industrial buildings. They are only a little greater than the duct diameter and are easy to install under suspended ceilings, wall panelling, above and in fitted wardrobes or behind bulkheads.

HELIOS RR AND RRK



Used to carry medium to small air volumes against high resistance. For a number of applications in the residential, commercial and industrial sectors. Available in galvanised sheet steel or corrosion-resistant polymer.

HELIOS ACOUSTIC LINE



SlimVent centrifugal in-line fans with noise insulation and Helios SilentBox® for particularly quiet operation.

Energy-efficient EC version
Ø 100 to 315 mm, $\dot{V} = 360$ to 1850 m³/h.

320^{on}

Standard AC types
Ø 100 to 315 mm, $\dot{V} = 250$ to 1260 m³/h.

330^{on}

342^{on}

SVV 80

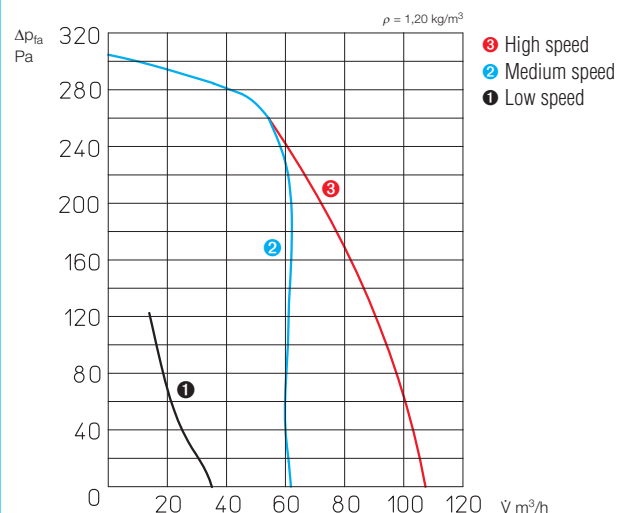

* Performance curve with factory-provided spigot position

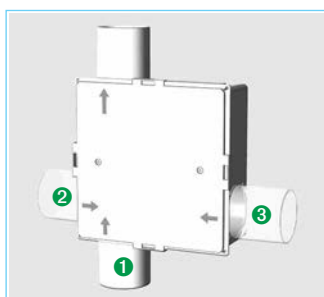
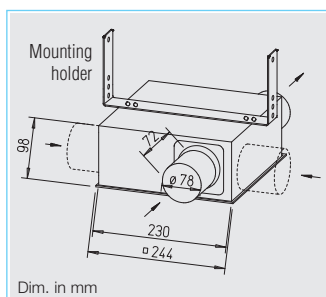

Spigot position			Total power
No. 1	No. 2	No. 3	∑ m³/h
35	45	45	125
65	closed	60	125
closed	45	75	120
50	60	closed	110
110*	closed*	closed*	110*
closed	closed	110	110
closed	100	closed	100

■ The air flow volume varies with the number and position of the intake spigots.

■ Description

- Exceptionally flat and robust unit from impact resistant polymer. Suitable for ventilation of bathrooms, toilets, etc. in industrial, commercial and domestic applications. Delivered complete with extract and supply connection spigot for standard pipe diameter. For the ventilation of several rooms one or two further intake air spigots can be attached to the casing by removing the blanking covers

- Simply take off cover plate to remove fan unit, leaving the casing in situ.

□ Impeller

Highly efficient forward curved centrifugal impeller made from high quality polymer.

□ Motor

Totally enclosed, maintenance-free and energy saving ball bearing motor.

□ Motor protection

Through thermal overload protection in the winding.

□ Speed control

Manual three-stage operation by means of DSEL 3. Medium or low speed connectable for continuous operation and switchable by means of DSEL 2.

□ Electrical connection

Terminal box (IP 55) located on outer casing.

□ Installation

May be fitted in any position. The removing of the fan unit from its casing allows change or cleaning without removing the casing from the ducting. The inspection flap must be considered.

□ Protection

When connected to a ducted system protection to IP 54.

■ Scope of delivery and accessories

SlimVent is supplied with mounting holder. One intake and extract spigot. One or two further intake spigots (accessories Ø 75/80) can be assembled to the casing by removing the blanking cover.

ELS-ZAS Ref. no. 8184

Three speed operation and on/off operation switch.

Convenient flush-mounted speed controller. Cannot be switched in parallel.

Installation in flush-mounted gang box.

Dim. mm (WxHxD) 80 x 80 x 23
Type DSEL 3 Ref. no. 1611



Type	Ref. no.	Connection Ø	Air flow volume (FID)	Nominal R.P.M.*	Sound pressure level case breakout*	Sound pressure level intake*	Power consumption*	Current*	Wiring diagram ¹⁾	max. air flow temperature	Weight net approx.
		mm	∑ m³/h	min ⁻¹	dB(A) in 3m/1m	dB(A) in 3m/1m	W	A	No.	+ °C	kg
Single-phase motor, 230 V, 50 Hz, IP 45											
SVV 80	2660	80	110 / 65 / 35	2710 / 1200 / 650	29/37 18/26 16/24	35/43 24/32 17/25	27 / 20 / 11	0.13 / 0.12 / 0.09	913	40	2.0

* Values are related to the 3 speeds (see performance diagram).

¹⁾ With three speed operation switch DSEL 3: Connection according to wiring diagram no. 914.

Energy-saving EC in-line fans for medium to smaller air flow volumes against high resistances.

Specifically made for in-duct installation. High pressure performance to overcome friction loss, flow deflection losses and aggregate resistances.

Universal in application for domestic, commercial and industrial purposes.

Special features

- Highly efficient EC motor for lowest operating costs.
- Less space required and simple site installation of the compact in line design.
- Its simplicity reduces site costs.
- Supply and exhaust air spigots fit all standard circular duct sizes.
- Power adjustment by 100% variable speed control.
- Installation in any position.
- Wide range of accessories.
- Aerodynamically optimized casing design.

Common features RR EC and SVR EC

- Motor**
Energy saving, speed controllable EC-external rotor motors, protection to IP 44 (RR EC IP 54) with highest efficiency. Maintenance-free and interference-free, ball bearing mounted.
- Motor protection**
Integrated electronic temperature monitoring for EC-motor and electronics.
- Installation**
Can be mounted in any position – horizontal, vertical or diagonal – suitable for supply and extract ventilation by correct installation. To minimise the effective noise level it is recommended that the fan is installed as remote as possible from the ventilated space.

RR EC

EC series offering excellent value for money.

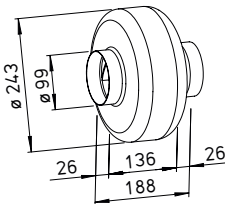

Dim. in mm

Specification RR EC

- Casing**
Robust casing from galvanised sheet steel for harsh operating conditions. Intake and exhaust Spigots on intake and exhaust fit standard ducts.
- Speed control**
Stepless speed control with potentiometer or stepless speed control with universal control system (see table). Duties at different speeds are exemplarily given in the performance curve.
- Electrical connection**
Terminal box (IP 54) located on outer casing.
- Impeller**
Backward curved centrifugal impeller made from polymers. Directly fitted on motor and dynamically balanced as a unit providing low noise levels and high efficiency.
- Protection class**
When installed in intake and exhaust ducting and rainwater penetration is prevented, the fan is rated IP 54.

SVR EC

SlimVent – Exceptionally flat space saving miracle with swing out motor and impeller unit.

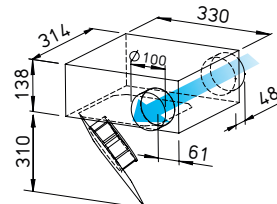

Dim. in mm

Specification SVR EC

- Casing**
Flat and robust casing from galvanised sheet steel. Spigots on intake and extract with twin-seal rubber gaskets fit into standard ducts. Particularly service-friendly (cleaning) through swing out motor and impeller unit without disassembly of system components. Space for the swing out facility must be considered.
- Speed control**
Stepless speed control with potentiometer or stepless speed control with universal control system (see table). Duties at different speeds are exemplarily given in the performance curve.
- Electrical connection**
Terminal box (IP 54) fitted to running cable.
- Impeller**
Energy-saving centrifugal impeller with forward curved blades. Dynamically balanced for low noise operation.
- Protection class**
When installed in ducting the fan is rated IP 44.

Sound levels

Total sound power levels and the spectrum figures in dB(A) are given for:
 – Sound level case breakout
 – Sound level intake
 – Sound level exhaust
 In the table below as well as underneath the performance curve you can find additionally the sound pressure level at 1 m (freefield conditions).

Type	Ref. no.	Connection Ø	Air flow volume (FID)	Nominal R.P.M.	Sound press. case breakout	Power consumption	Current	Wiring diagram	max. air flow temperature	Weight net approx.	Universal control system		Speed-potentiometer			
											Type	Ref. no.	Type	Ref. no.	Type	Ref. no.
Type RR EC, 1 Phase motor, 230 V, 50/60 Hz, EC motor, IP 54																
RR EC 100	5804	100	360	3600	45	0.11	0.90	979	60	3.0	EUR EC ¹⁾²⁾	1347	PU 10 ¹⁾	1734	PA 10 ¹⁾	1735
Type SVR EC, 1 Phase motor, 230 V, 50/60 Hz, EC motor, IP 44																
SVR EC 100	6124	100	420	3780	56	0.11	0.88	979	60	6.2	EUR EC ¹⁾²⁾	1347	PU 10 ¹⁾	1734	PA 10 ¹⁾	1735

1) Several EC fans can normally be connected 2) alternative electronic diff. pressure/Temp. controller (EDR/ETR, no. 1437/1438) or three-stage speed controller (SU/SA, no. 4266/4267), see accessories

RR EC 100

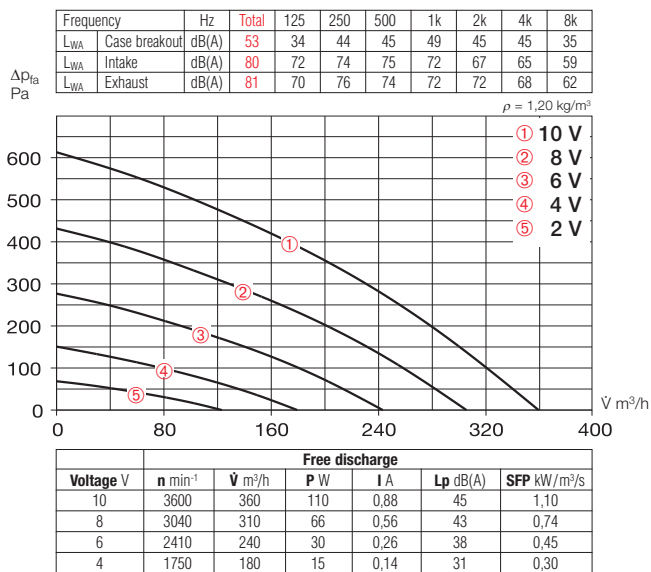

SVR EC 100

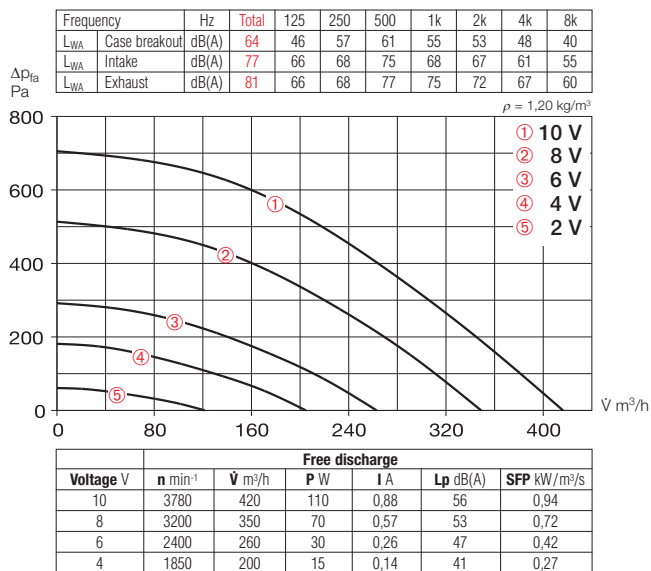

Accessory details Page

Filters, heater batteries and attenuators 421 on
Temperature control systems for heater batteries 427, 431 on
Flexible ventilation ducting, grilles, adaptors, roof terminations 487 on
Poppet valves 508 on
Universal control system, electronic controllers, speed-potentiometer 539 on

Accessories

Pipe clamp connectors

Type BM 100 Ref. no. 5075
A quick-fix method for connecting fans to ducting, reducing vibration transmission (1 kit = 2 pieces). When installing leave a little gap between fan and ducting.

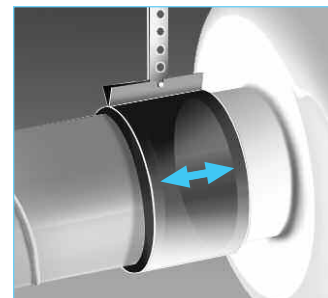

Mounting feet for RR EC

Type MK 4 Ref. no. 5824



Gravity shutter

Type VK 100 Ref. no. 0757
Automatic made from white polymer.

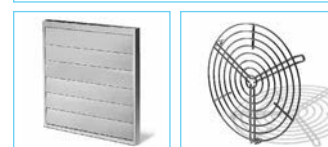

Rain repellent grille

Type G 100 Ref. no. 0796
Made from white polymer.

Guard

Type SGR 100 Ref. no. 5063
For intake and exhaust installation on fan, made from powder-coated steel wire.



Backdraught shutter

Type RSKK 100 Ref. no. 5106
Automatic, made from polymer.



Flexible attenuator

Type FSD 100 Ref. no. 0676
Spigotted aluminium attenuator with 50 mm insulation. Length 1 m.



Air filter box

LFBR 100 G4 Ref. no. 8576
LFBR 100 F7 Ref. no. 8530
Air filter with large surface area to be installed in-line with ducting.



Electric heater batteries

EHR-R 0,4/100 0,4 kW No. 8708
In galvanised sheet steel casing.



Temperature control system for electric heater batteries EHR-R

Type EHS Ref. no. 5002

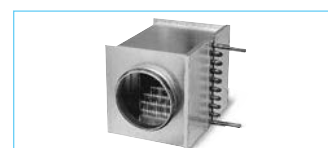

Warm water heater battery

Type WHR 100 Ref. no. 9479
Compact heat exchanger for in-line installation.



Temperature control system for warm water heater battery

Type WHST 300 T38 No. 8817

Energy-saving EC in-line fans for medium to smaller air flow volumes against high resistances.

Specifically made for in-duct installation. High pressure performance to overcome friction loss, flow deflection losses and aggregate resistances.

Universal in application for domestic, commercial and industrial purposes.

Special features

- Highly efficient EC motor for lowest operating costs.
- Less space required and simple site installation of the compact in line design.
- Its simplicity reduces site costs.
- Supply and exhaust air spigots fit all standard circular duct sizes.
- Power adjustment by 100% variable speed control.
- Installation in any position.
- Wide range of accessories.
- Aerodynamically optimized casing design.

Common features RR EC and SVR EC

- Motor**
Energy saving, speed controllable EC-external rotor motors, protection to IP 44 (RR EC IP 54) with highest efficiency. Maintenance-free and interference-free, ball bearing mounted.
- Motor protection**
Integrated electronic temperature monitoring for EC-motor and electronics.
- Installation**
Can be mounted in any position – horizontal, vertical or diagonal – suitable for supply and extract ventilation by correct installation. To minimise the effective noise level it is recommended that the fan is installed as remote as possible from the ventilated space.

RR EC

EC series offering excellent value for money.

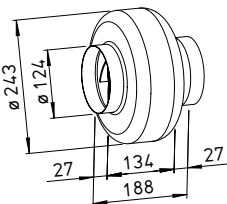

Dim. in mm

Specification RR EC

- Casing**
Robust casing from galvanised sheet steel for harsh operating conditions. Intake and exhaust Spigots on intake and exhaust fit standard ducts.
- Speed control**
Stepless speed control with potentiometer or stepless speed control with universal control system (see table). Duties at different speeds are exemplarily given in the performance curve.
- Electrical connection**
Terminal box (IP 54) located on outer casing.
- Impeller**
Backward curved centrifugal impeller made from polymers. Directly fitted on motor and dynamically balanced as a unit providing low noise levels and high efficiency.
- Protection class**
When installed in intake and exhaust ducting and rainwater penetration is prevented, the fan is rated IP 54.

SVR EC

SlimVent – Exceptionally flat space saving miracle with swing out motor and impeller unit.

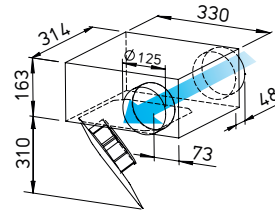

Dim. in mm

Specification SVR EC

- Casing**
Flat and robust casing from galvanised sheet steel. Spigots on intake and extract with twin-seal rubber gaskets fit into standard ducts. Particularly service-friendly (cleaning) through swing out motor and impeller unit without disassembly of system components. Space for the swing out facility must be considered.
- Speed control**
Stepless speed control with potentiometer or stepless speed control with universal control system (see table). Duties at different speeds are exemplarily given in the performance curve.
- Electrical connection**
Terminal box (IP 54) fitted to running cable.
- Impeller**
Energy-saving centrifugal impeller with forward curved blades. Dynamically balanced for low noise operation.
- Protection class**
When installed in ducting the fan is rated IP 44.

Sound levels

Total sound power levels and the spectrum figures in dB(A) are given for:
 – Sound level case breakout
 – Sound level intake
 – Sound level exhaust
 In the table below as well as underneath the performance curve you can find additionally the sound pressure level at 1 m (freefield conditions).

Type	Ref. no.	Connection Ø	Air flow volume (FID)	Nominal R.P.M.	Sound press. case breakout	Power consumption	Current	Wiring diagram	max. air flow temperature	Weight net approx.	Universal control system		Speed-potentiometer			
											Type	Ref. no.	Type	Ref. no.	Type	Ref. no.
Type RR EC, 1 Phase motor, 230 V, 50/60 Hz, EC motor, IP 54																
RR EC 125	5789	125	540	3540	45	0.11	0.87	979	60	3.0	EUR EC ¹⁾²⁾	1347	PU 10 ¹⁾	1734	PA 10 ¹⁾	1735
Type SVR EC, 1 Phase motor, 230 V, 50/60 Hz, EC motor, IP 44																
SVR EC 125	2531	125	580	3780	57	0.12	0.90	979	60	5.0	EUR EC ¹⁾²⁾	1347	PU 10 ¹⁾	1734	PA 10 ¹⁾	1735

1) Several EC fans can normally be connected 2) alternative electronic diff. pressure/Temp. controller (EDR/ETR, no. 1437/1438) or three-stage speed controller (SU/SA, no. 4266/4267), see accessories

RR EC 125

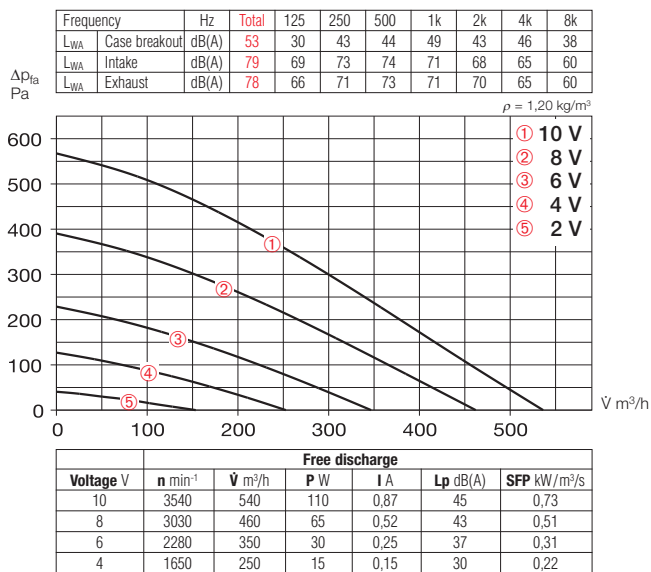

SVR EC 125

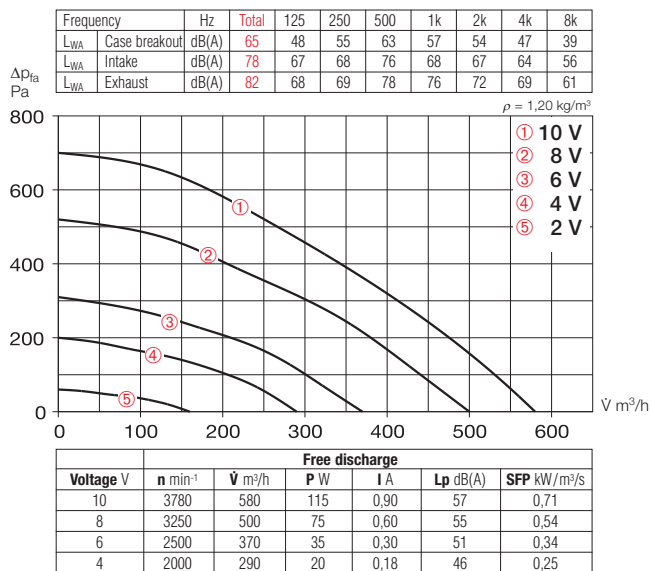

Accessory details Page

Filters, heater batteries and attenuators	421 on
Temperature control systems for heater batteries	427, 431 on
Flexible ventilation ducting, grilles, adaptors, roof terminations	487 on
Poppet valves	508 on
Universal control system, electronic controllers, speed-potentiometer	539 on

Accessories

Pipe clamp connectors

Type BM 125 Ref. no. 5076
A quick-fix method for connecting fans to ducting, reducing vibration transmission (1 kit = 2 pieces). When installing leave a little gap between fan and ducting.

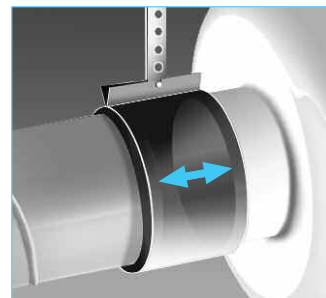

Mounting feet for RR EC

Type MK 4 Ref. no. 5824



Gravity shutter

Type VK 125 Ref. no. 0857
Automatic made from white polymer.

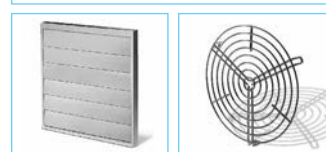

Rain repellent grille

Type G 160 Ref. no. 0893
Made from white polymer.

Guard

Type SGR 125 Ref. no. 5064
For intake and exhaust installation on fan, made from powder-coated steel wire.



Backdraught shutter

Type RSKK 125 Ref. no. 5107
Automatic, made from polymer.



Flexible attenuator

Type FSD 125 Ref. no. 0677
Spigotted aluminium attenuator with 50 mm insulation. Length 1 m.



Air filter box

LFBR 125 G4 Ref. no. 8577
LFBR 125 F7 Ref. no. 8531
Air filter with large surface area to be installed in-line with ducting.



Electric heater batteries

EHR-R 0,8/125 0,8 kW No. 8709
EHR-R 1,2/125 1,2 kW No. 9433
– with integrated temp. control
EHR-R 0,8/125 TR 0,8 kW No. 5293
Room or duct sensor required (TFK/TFR, accessories).



Temperature control system for electric heater batteries EHR-R

Type EHS Ref. no. 5002

Warm water heater battery

Type WHR 125 Ref. no. 9480
Compact heat exchanger for in-line installation.



Temperature control system for warm water heater battery

Type WHST 300 T38 No. 8817



Energy-saving EC in-line fans for medium to smaller air flow volumes against high resistances.

Specifically made for in-duct installation. High pressure performance to overcome friction loss, flow deflection losses and aggregate resistances. Universal in application for domestic, commercial and industrial purposes.

Special features

- Highly efficient EC motor for lowest operating costs.
- Less space required and simple site installation of the compact in line design.
- Its simplicity reduces site costs.
- Supply and exhaust air spigots fit all standard circular duct sizes.
- Power adjustment by 100% variable speed control.
- Installation in any position.
- Wide range of accessories.
- Aerodynamically optimized casing design.

Common features RR EC and SVR EC

- Motor**
Energy saving, speed controllable EC-external rotor motors, protection to IP 44 (RR EC IP 54) with highest efficiency. Maintenance-free and interference-free, ball bearing mounted.
- Motor protection**
Integrated electronic temperature monitoring for EC-motor and electronics.
- Installation**
Can be mounted in any position – horizontal, vertical or diagonal – suitable for supply and extract ventilation by correct installation. To minimise the effective noise level it is recommended that the fan is installed as remote as possible from the ventilated space.

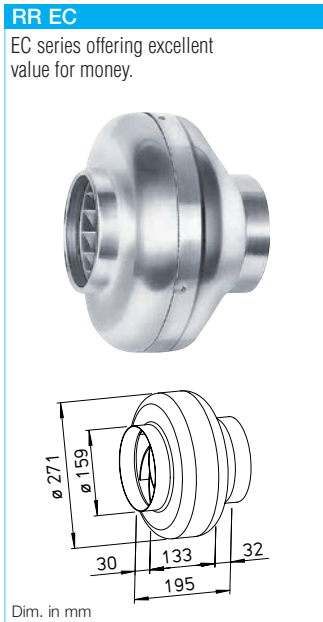

Specification RR EC

- Casing**
Robust casing from galvanised sheet steel for harsh operating conditions. Intake and exhaust Spigots on intake and exhaust fit standard ducts.
- Speed control**
Stepless speed control with potentiometer or stepless speed control with universal control system (see table). Duties at different speeds are exemplarily given in the performance curve.
- Electrical connection**
Terminal box (IP 54) located on outer casing.
- Impeller**
Backward curved centrifugal impeller made from polymers. Directly fitted on motor and dynamically balanced as a unit providing low noise levels and high efficiency.
- Protection class**
When installed in intake and exhaust ducting and rainwater penetration is prevented, the fan is rated IP 54.

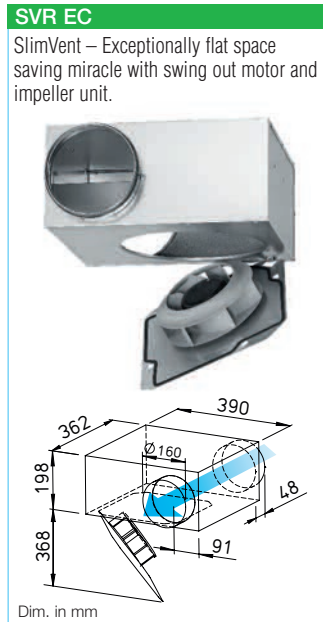

Specification SVR EC

- Casing**
Flat and robust casing from galvanised sheet steel. Spigots on intake and extract with twin-seal rubber gaskets fit into standard ducts. Particularly service-friendly (cleaning) through swing out motor and impeller unit without disassembly of system components. Space for the swing out facility must be considered.
- Speed control**
Stepless speed control with potentiometer or stepless speed control with universal control system (see table). Duties at different speeds are exemplarily given in the performance curve.
- Electrical connection**
Terminal box (IP 54) fitted to running cable.
- Impeller**
Energy-saving centrifugal impeller with forward curved blades. Dynamically balanced for low noise operation.
- Protection class**
When installed in ducting the fan is rated IP 44.

Sound levels

Total sound power levels and the spectrum figures in dB(A) are given for:
 – Sound level case breakout
 – Sound level intake
 – Sound level exhaust
 In the table below as well as underneath the performance curve you can find additionally the sound pressure level at 1 m (freefield conditions).

Type	Ref. no.	Connection Ø	Air flow volume (FID)	Nominal R.P.M.	Sound press. case breakout	Power consumption	Current	Wiring diagram	max. air flow temperature	Weight net approx.	Universal control system		Speed-potentiometer			
											Type	Ref. no.	Type	Ref. no.	Type	Ref. no.
Type RR EC, 1 Phase motor, 230 V, 50/60 Hz, EC motor, IP 54																
RR EC 160	5785	160	680	3570	39	0.11	0.90	979	60	3.0	EUR EC ¹⁾²⁾	1347	PU 10 ¹⁾	1734	PA 10 ¹⁾	1735
Type SVR EC, 1 Phase motor, 230 V, 50/60 Hz, EC motor, IP 44																
SVR EC 160 A	2535	160	640	3640	57	0.12	0.90	979	60	7.1	EUR EC ¹⁾²⁾	1347	PU 10 ¹⁾	1734	PA 10 ¹⁾	1735
SVR EC 160 B	2543	160	820	3220	57	0.13	1.06	979	60	6.9	EUR EC ¹⁾²⁾	1347	PU 10 ¹⁾	1734	PA 10 ¹⁾	1735

1) Several EC fans can normally be connected 2) alternative electronic diff. pressure/Temp. controller (EDR/ETR, no. 1437/1438) or three-stage speed controller (SU/SA, no. 4266/4267), see accessories

RR EC 160

Frequency	Hz	Total	125	250	500	1k	2k	4k	8k
L _{WA} Case breakout	dB(A)	47	29	38	39	40	42	39	32
L _{WA} Intake	dB(A)	75	64	68	71	68	64	63	60
L _{WA} Exhaust	dB(A)	78	64	69	74	69	69	67	62

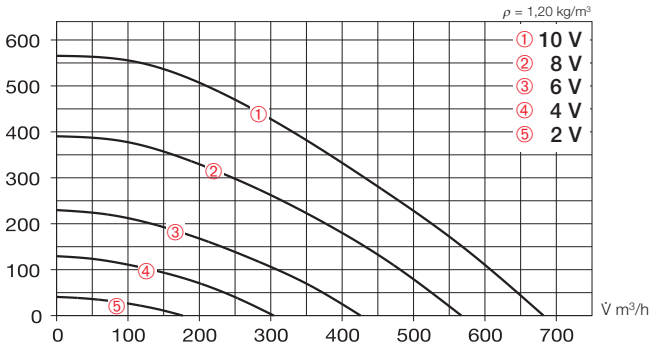

Free discharge						
Voltage V	n min ⁻¹	V̇ m³/h	P W	I A	Lp dB(A)	SFP kW/m³/s
10	3570	680	100	0,85	39	0,53
8	3000	570	60	0,50	36	0,38
6	2250	430	25	0,25	30	0,21
4	1630	300	10	0,11	23	0,12

SVR EC 160 A

Frequency	Hz	Total	125	250	500	1k	2k	4k	8k
L _{WA} Case breakout	dB(A)	65	50	52	64	53	51	45	38
L _{WA} Intake	dB(A)	78	67	70	74	70	63	64	56
L _{WA} Exhaust	dB(A)	80	66	71	77	71	70	69	60

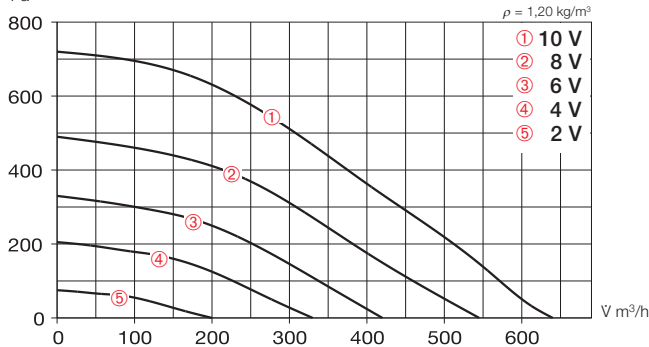

Free discharge						
Voltage V	n min ⁻¹	V̇ m³/h	P W	I A	Lp dB(A)	SFP kW/m³/s
10	3640	640	115	0,88	57	0,65
8	3130	540	70	0,61	55	0,47
6	2550	420	40	0,33	51	0,34
4	2000	330	20	0,18	46	0,22

SVR EC 160 B

Frequency	Hz	Total	125	250	500	1k	2k	4k	8k
L _{WA} Case breakout	dB(A)	65	49	57	62	54	53	48	38
L _{WA} Intake	dB(A)	79	66	73	77	69	65	65	55
L _{WA} Exhaust	dB(A)	82	67	74	78	72	73	71	60

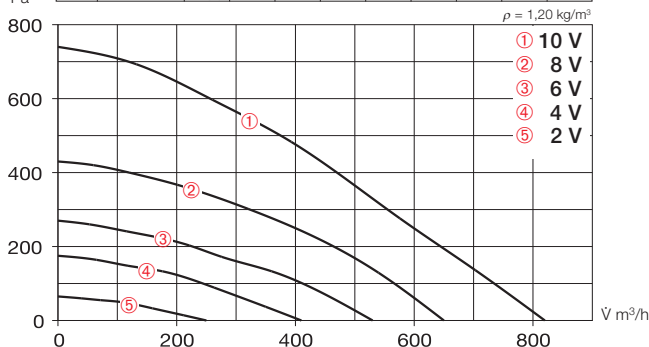

Free discharge						
Voltage V	n min ⁻¹	V̇ m³/h	P W	I A	Lp dB(A)	SFP kW/m³/s
10	3220	820	130	1,1	57	0,58
8	2600	650	70	0,55	42	0,37
6	2050	530	40	0,32	37	0,27
4	1650	410	20	0,19	32	0,19

Accessories

Pipe clamp connectors

Type BM 160 Ref. no. 5077
A quick-fix method for connecting fans to ducting, reducing vibration transmission (1 kit = 2 pieces). When installing leave a little gap between fan and ducting.

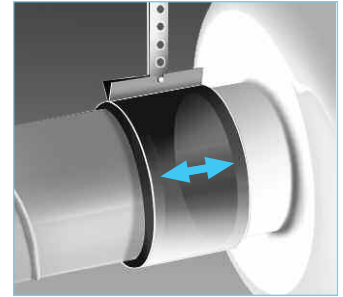

Mounting feet for RR EC

Type MK 4 Ref. no. 5824



Gravity shutter

Type VK 160 Ref. no. 0892
Automatic made from white polymer.



Rain repellent grille

Type G 160 Ref. no. 0893
Made from white polymer.

Guard

Type SGR 160 Ref. no. 5069
For intake and exhaust installation on fan, made from galvanised steel.



Backdraught shutter

Type RSK 160 Ref. no. 5669
Automatic, made from metal.



Flexible attenuator

Type FSD 160 Ref. no. 0678
Spigotted aluminium attenuator with 50 mm insulation. Length 1 m.



Air filter box

LFBR 160 G4 Ref. no. 8578
LFBR 160 F7 Ref. no. 8532
Air filter with large surface area to be installed in-line with ducting.

Electric heater batteries

EHR-R 1,2/160 1,2 kW No. 9434
EHR-R 2,4/160 2,4 kW No. 9435
EHR-R 5/160 5,0 kW No. 8710
- with integrated temp. control
EHR-R 2,4/160 TR 2,4 kW No. 5294
Room or duct sensor required (TFK/TFR, accessory).



Temperature control system for electric heater batteries EHR-R
Type EHS Ref. no. 5002



Warm water heater battery

Type WHR 160 Ref. no. 9481
Compact heat exchanger for in-line installation.

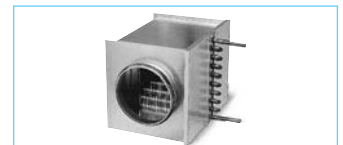

Temperature control system for warm water heater battery
Type WHST 300 T38 No. 8817



Energy-saving EC in-line fans for medium to smaller air flow volumes against high resistances.

Specifically made for in-duct installation. High pressure performance to overcome friction loss, flow deflection losses and aggregate resistances. Universal in application for domestic, commercial and industrial purposes.

Special features

- Highly efficient EC motor for lowest operating costs.
- Less space required and simple site installation of the compact in line design.
- Its simplicity reduces site costs.
- Supply and exhaust air spigots fit all standard circular duct sizes.
- Power adjustment by 100% variable speed control.
- Installation in any position.
- Wide range of accessories.
- Aerodynamically optimized casing design.

Common features RR EC and SVR EC

- Motor**
Energy saving, speed controllable EC-external rotor motors, protection to IP 44 (RR EC 200 A IP 54) with highest efficiency. Maintenance-free and interference-free, ball bearing mounted.
- Motor protection**
Integrated electronic temperature monitoring for EC-motor and electronics.
- Installation**
Can be mounted in any position – horizontal, vertical or diagonal – suitable for supply and extract ventilation by correct installation. To minimise the effective noise level it is recommended that the fan is installed as remote as possible from the ventilated space.

RR EC

EC series offering excellent value for money.

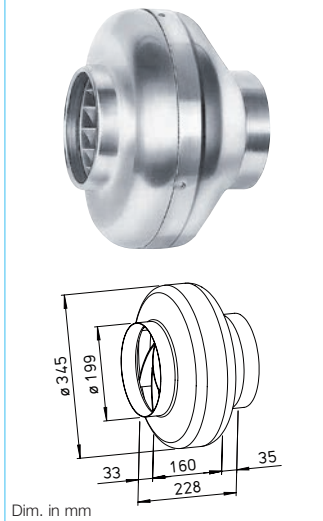

Specification RR EC

- Casing**
Robust casing from galvanised sheet steel for harsh operating conditions. Intake and exhaust Spigots on intake and exhaust fit standard ducts.
- Speed control**
Stepless speed control with potentiometer or stepless speed control with universal control system (see table). Duties at different speeds are exemplarily given in the performance curve.
- Electrical connection**
Terminal box (IP 54) located on outer casing.
- Impeller**
Backward curved centrifugal impeller made from polymers. Directly fitted on motor and dynamically balanced as a unit providing low noise levels and high efficiency.
- Protection class**
When installed in intake and exhaust ducting and rainwater penetration is prevented, the fan is rated IP 54 for RR EC 200 A IP 54.

SVR EC

SlimVent – Exceptionally flat space saving miracle with swing out motor and impeller unit.

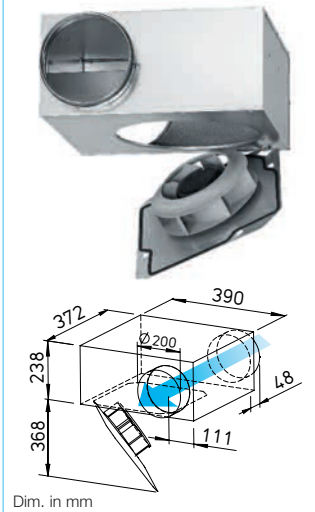

Specification SVR EC

- Casing**
Flat and robust casing from galvanised sheet steel. Spigots on intake and extract with twin-seal rubber gaskets fit into standard ducts. Particularly service-friendly (cleaning) through swing out motor and impeller unit without disassembly of system components. Space for the swing out facility must be considered.
- Speed control**
Stepless speed control with potentiometer or stepless speed control with universal control system (see table). Duties at different speeds are exemplarily given in the performance curve.
- Electrical connection**
Terminal box (IP 54) fitted to running cable.
- Impeller**
Energy-saving centrifugal impeller with forward curved blades. Dynamically balanced for low noise operation.
- Protection class**
When installed in ducting the fan is rated IP 44.

Sound levels

Total sound power levels and the spectrum figures in dB(A) are given for:
 – Sound level case breakout
 – Sound level intake
 – Sound level exhaust
 In the table below as well as underneath the performance curve you can find additionally the sound pressure level at 1 m (freefield conditions).

Type	Ref. no.	Connection Ø	Air flow volume (FID)	Nominal R.P.M.	Sound press. case breakout	Power consumption	Current	Wiring diagram	max. air flow temperature	Weight net approx.	Universal control system		Speed-potentiometer			
											Type	Ref. no.	Type	Ref. no.	Type	Ref. no.
Type RR EC, 1 Phase motor, 230 V, 50/60 Hz, EC motor, IP 54 (A), IP 44 (B)																
RR EC 200 A	6121	200	950	2900	45	0.12	0.97	979	60	4.0	EUR EC ¹⁾²⁾	1347	PU 10 ¹⁾	1734	PA 10 ¹⁾	1735
RR EC 200 B	5786	200	1130	3250	46	0.15	1.21	979	60	3.7	EUR EC ¹⁾²⁾	1347	PU 10 ¹⁾	1734	PA 10 ¹⁾	1735
Type SVR EC, 1 Phase motor, 230 V, 50/60 Hz, EC motor, IP 44																
SVR EC 200	2539	200	1030	2870	55	0.16	1.27	979	60	7.4	EUR EC ¹⁾²⁾	1347	PU 10 ¹⁾	1734	PA 10 ¹⁾	1735

1) Several EC fans can normally be connected 2) alternative electronic diff. pressure/Temp. controller (EDR/ETR, no. 1437/1438) or three-stage speed controller (SU/SA, no. 4266/4267), see accessories

RR EC 200 A

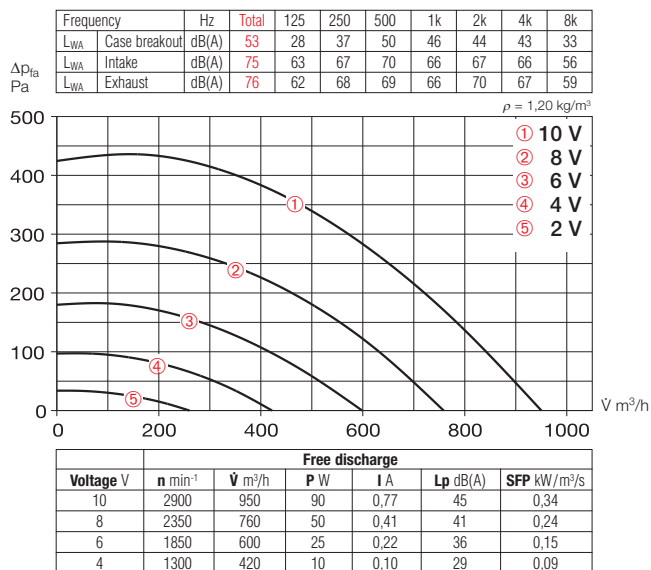

RR EC 200 B

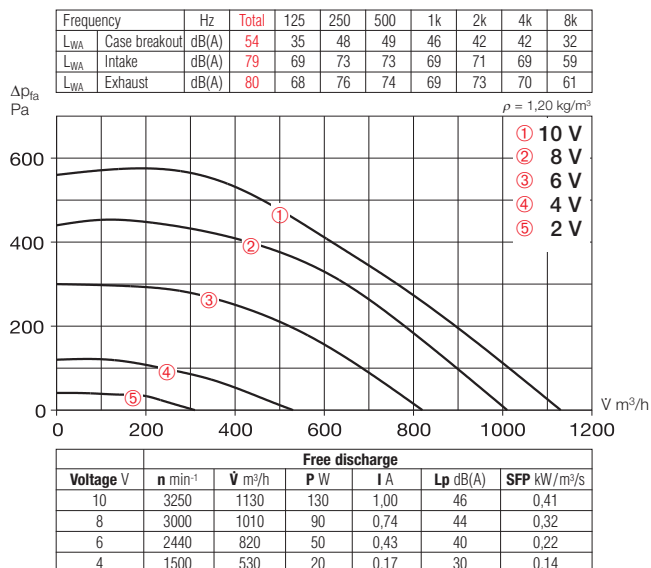

SVR EC 200

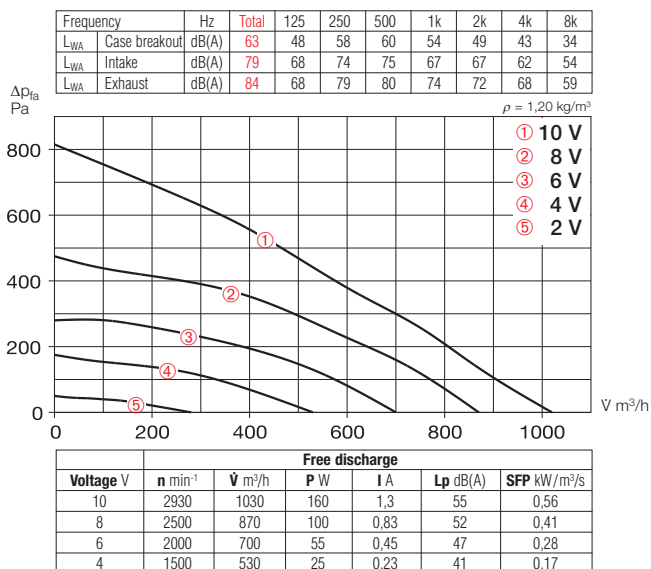

Accessories

Pipe clamp connectors

Type BM 200 Ref. no. 5078
A quick-fix method for connecting fans to ducting, reducing vibration transmission (1 kit = 2 pieces). When installing leave a little gap between fan and ducting.

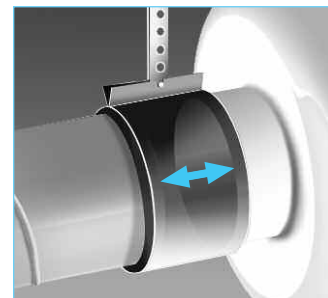

Mounting feet for RR EC

Type MK 4 Ref. no. 5824



Gravity shutter

Type VK 200 Ref. no. 0758
Made from polymer, light grey.

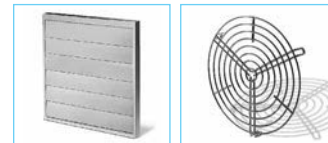

Rain repellent grille

Type RAG 200 Ref. no. 0750
Made from polymer, light grey.

Guard

Type SGR 200 Ref. no. 5066
For intake and exhaust installation on fan, made from galvanised steel.



Backdraught shutter

Type RSK 200 Ref. no. 5074
Automatic, made from metal.



Flexible attenuator

Type FSD 200 Ref. no. 0679
Spigotted aluminium attenuator with 50 mm insulation. Length 1 m.



Air filter box

LFBR 200 G4 Ref. no. 8579
LFBR 200 F7 Ref. no. 8533
Air filter with large surface area to be installed in-line with ducting.



Electric heater batteries

EHR-R 1,2/200 1,2 kW No. 9436
EHR-R 2/200 2,0 kW No. 9437
EHR-R 5/200 5,0 kW No. 8711
- with integrated temp. control
EHR-R 5/200 TR 5,0 kW No. 5295
Room or duct sensor required (TFK/TFR, accessory).



Temperature control system for electric heater batteries EHR-R
Type EHS Ref. no. 5002



Warm water heater battery

Type WHR 200 Ref. no. 9482
Compact heat exchanger for in-line installation.



Temperature control system for warm water heater battery
Type WHST 300 T38 No. 8817





Energy-saving EC in-line fans for medium to smaller air flow volumes against high resistances.

Specifically made for in-duct installation. High pressure performance to overcome friction loss, flow deflection losses and aggregate resistances. Universal in application for domestic, commercial and industrial purposes.

Special features

- Highly efficient EC motor for lowest operating costs.
- Less space required and simple site installation of the compact in line design.
- Its simplicity reduces site costs.
- Supply and exhaust air spigots fit all standard circular duct sizes.
- Power adjustment by 100% variable speed control.
- Installation in any position.
- Wide range of accessories.
- Aerodynamically optimized casing design.

RR EC 250

EC series offering excellent value for money.

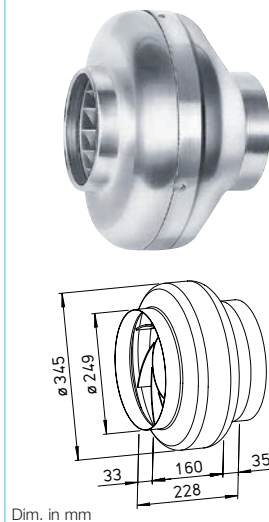

Dim. in mm

Specification

- Motor**
Energy saving, speed controllable EC-external rotor motors, protection to IP 44 (RR EC 200 A IP 54) with highest efficiency. Maintenance-free and interference-free, ball bearing mounted.
- Motor protection**
Integrated electronic temperature monitoring for EC-motor and electronics.
- Casing**
Robust casing from galvanised sheet steel for harsh operating conditions. Intake and exhaust Spigots on intake and exhaust fit standard ducts.

RR EC 315

EC series offering excellent value for money.

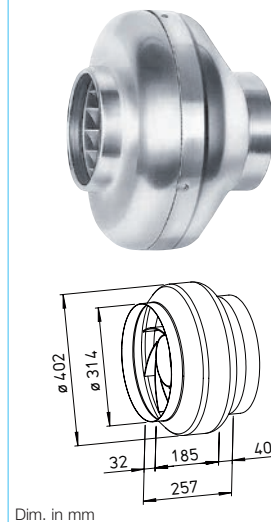

Dim. in mm

Speed control

Stepless speed control with potentiometer or stepless speed control with universal control system (see table). Duties at different speeds are exemplarily given in the performance curve.

Electrical connection

Terminal box (IP 54) on outside of casing.

Impeller

Centrifugal impeller with backward curved polymer blades, for RR EC 315 B impeller made from galvanised steel sheet. Dynamically balanced for low noise operation, highly efficient.

Protection class

When installed in intake and exhaust ducting and rainwater penetration is prevented, the fan is rated IP 54 for RR EC 200 A IP 54.

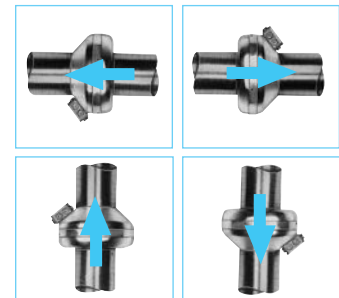
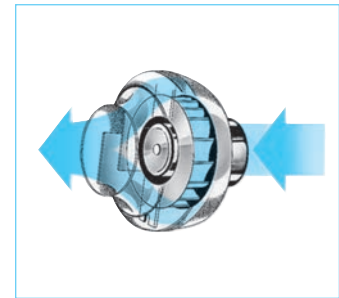

Installation

Can be mounted in any position – horizontal, vertical or diagonal – suitable for supply and extract ventilation by correct installation. To minimise the effective noise level it is recommended that the fan is installed as remote as possible from the ventilated space.

Sound levels

Total sound power levels and the spectrum figures in dB(A) are given for:
 – Sound level case breakout
 – Sound level intake
 – Sound level exhaust
 In the table below as well as underneath the performance curve you can find additionally the sound pressure level at 1 m (freefield conditions).

Type	Ref. no.	Connection Ø	Air flow volume (FID)	Nominal R.P.M.	Sound press. case breakout	Power consumption	Current	Wiring diagram	max. air flow temperature	Weight net approx.	Universal control system		Speed-potentiometer flush		Speed-potentiometer surface	
											Type	Ref. no.	Type	Ref. no.	Type	Ref. no.
Type RR EC, 1 phase motor, 230 V, 50/60 Hz, EC motor, IP 44 (250 A IP 54)																
RR EC 250 A	6122	250	970	2900	43	0.12	0.95	979	60	4.0	EUR EC ¹⁾²⁾	1347	PU 10 ¹⁾	1734	PA 10 ¹⁾	1735
RR EC 250 B	5787	250	1160	3330	45	0.16	1.30	979	60	3.9	EUR EC ¹⁾²⁾	1347	PU 10 ¹⁾	1734	PA 10 ¹⁾	1735
RR EC 315 A	5788	315	1300	3030	47	0.16	1.30	979	60	4.5	EUR EC ¹⁾²⁾	1347	PU 10 ¹⁾	1734	PA 10 ¹⁾	1735
RR EC 315 B ³⁾	6123	315	1850	2620	51	0.23	1.00	979	60	5.0	EUR EC ¹⁾²⁾	1347	PU 10 ¹⁾	1734	PA 10 ¹⁾	1735

1) Several EC fans can normally be connected 2) alternative electronic diff. pressure/Temp. controller (EDR/ETR, no. 1437/1438) or three-stage speed controller (SU/SA, no. 4266/4267), see accessories 3) Characteristic curve on www.HeliosSelect.de

RR EC 250 A

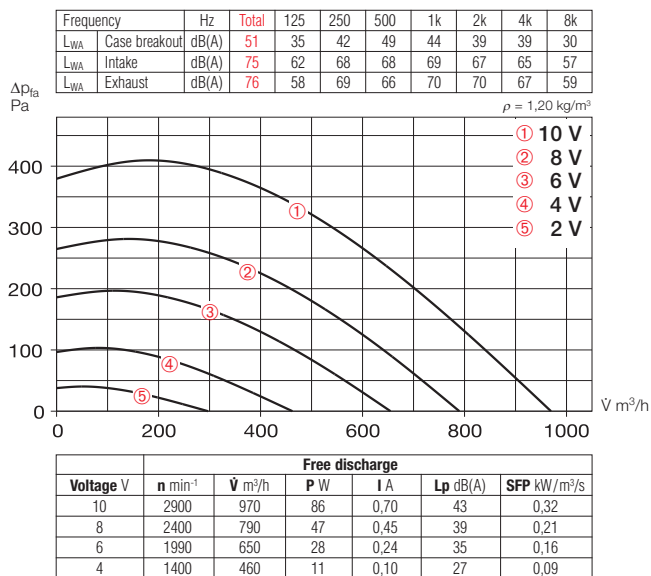

RR EC 250 B

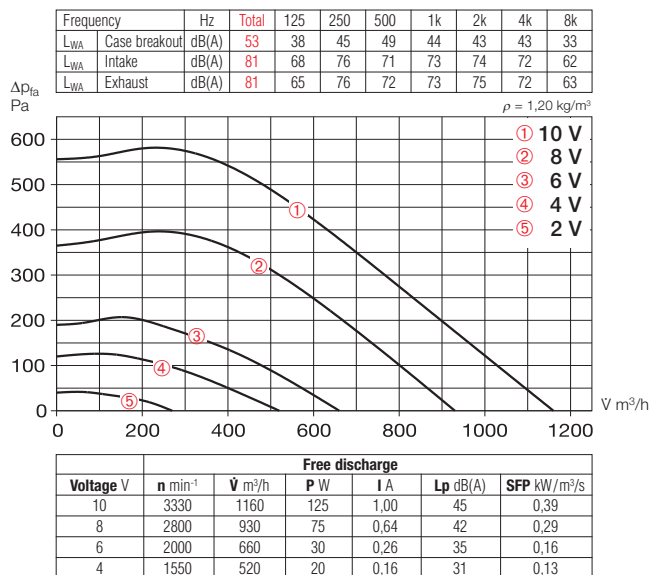

RR EC 315 A

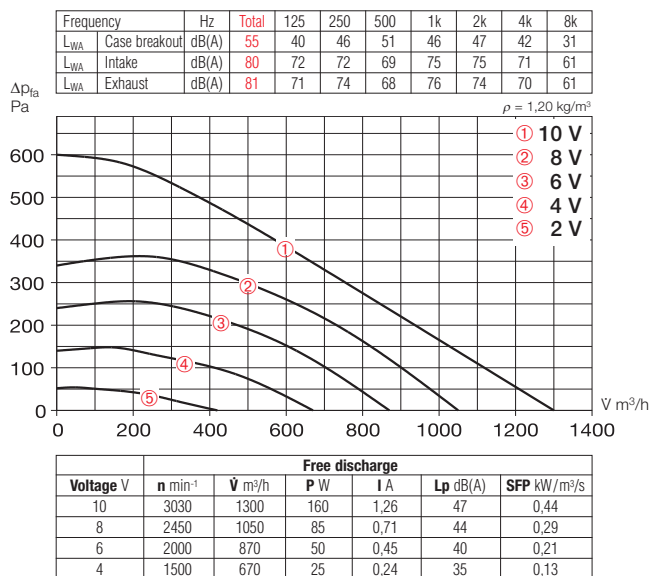

Accessories

Pipe clamp connectors

Type BM 250 Ref. no. 5079

Type BM 315 Ref. no. 5080

A quick-fix method for connecting fans to ducting, reducing vibration transmission (1 kit = 2 pieces). When installing leave a little gap between fan and ducting.

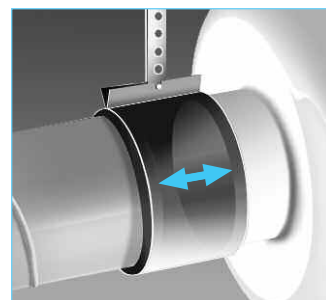

Mounting feet

Type MK 4 Ref. no. 5824

Made from galvanised steel sheet.



Gravity shutter

Type VK 250 Ref. no. 0759

Type VK 315 Ref. no. 0760

Automatic made from polymer, light grey.

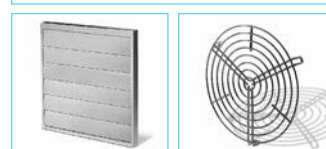

Rain repellent grille

Type RAG 250 Ref. no. 0751

Type RAG 315 Ref. no. 0752

Made from polymer, light grey.

Guard

Type SGR 250 Ref. no. 5067

Type SGR 315 Ref. no. 5068

For intake and exhaust installation on fan, made from galvanised steel.



Backdraught shutter

Type RSK 250 Ref. no. 5673

Type RSK 315 Ref. no. 5674

Automatic, made from metal.



Flexible attenuator

Type FSD 250 Ref. no. 0680

Type FSD 315 Ref. no. 0681

Spigotted aluminium attenuator with 50 mm insulation. Length 1 m.



Air filter box

LFBR 250 G4 Ref. no. 8580

LFBR 250 F7 Ref. no. 8534

LFBR 315 G4 Ref. no. 8581

LFBR 315 F7 Ref. no. 8535

Air filter with large surface area to be installed in-line with ducting.



Electric heater batteries

EHR-R 6/250 6,0 kW No. 8712

EHR-R 6/315 6,0 kW No. 8713

- with integrated temp. control

EHR-R 6/250 TR 6,0 kW No. 5296

EHR-R 6/315 TR 6,0 kW No. 5301

Room or duct sensor required (TFK/TFR, accessory).



Temperature control system for electric heater batteries EHR-R

Type EHS Ref. no. 5002

Warm water heater battery

Type WHR 250 Ref. no. 9483

Type WHR 315 Ref. no. 9484

Compact heat exchanger for in-line installation.

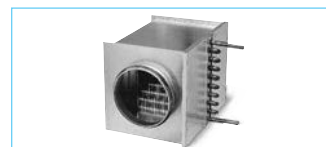

Temperature control system for warm water heater battery

Type WHS HE Ref. no. 8319



For medium to smaller air flow volumes against high resistances.

Specifically made for in-duct installation. High pressure characteristic to overcome resistances of bends, filters etc. Universal in application for domestic, commercial and industrial purposes.

Special features

- Less space required and simple site installation of the compact in line design.
- Its simplicity reduces site costs.
- Supply and exhaust air spigots fit all standard circular duct sizes.
- Power adjustment by 100% variable speed control.
- Installation in any position.
- Wide range of accessories.
- Aerodynamically optimized casing design.

Common features

- Motor**
Closed, ball bearing-mounted external rotor motor with humidity protection, insulation class F, for continuous operation, maintenance free and interference-free.
- Motor protection**
Automatically switches off and on again after cooling due to built-in thermal contacts with the winding wired in series.
- Installation**
Can be mounted in any position – horizontal, vertical or diagonal – suitable for supply and extract ventilation by correct installation. To minimise the effective noise level it is recommended that the fan is installed as remote as possible from the ventilated space.
- Sound levels**
See page 333.

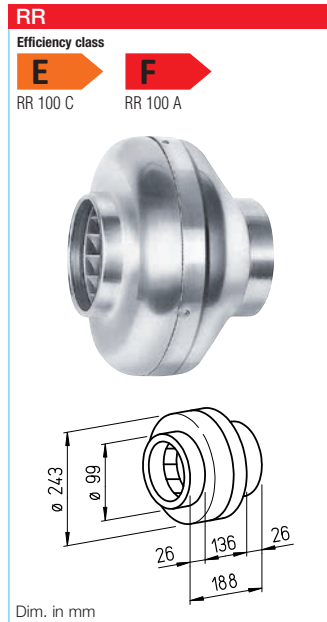

Specification RR

- Casing**
Robust casing from galvanised sheet steel for harsh operating conditions. Intake and exhaust Spigots on intake and exhaust fit standard ducts.
- Speed control**
Type RR 100 A from 0 – 100 % possible by means of electronic controller or step transformer (see table). For Type RR 100 C additional two-speed operation using Type DS 2/2 (accessories).
Type DS 2/2 Ref. no. 1267
- Electrical connection**
Terminal box (IP 54) located on outer casing.
- Impeller**
Centrifugal impeller with backward curved polymer blades. Directly mounted to motor and dynamically balanced as a unit. Low-noise, highly efficient.
- Protection class**
When installed in intake and exhaust ducting and rainwater penetration is prevented, the fan is rated IP 44.

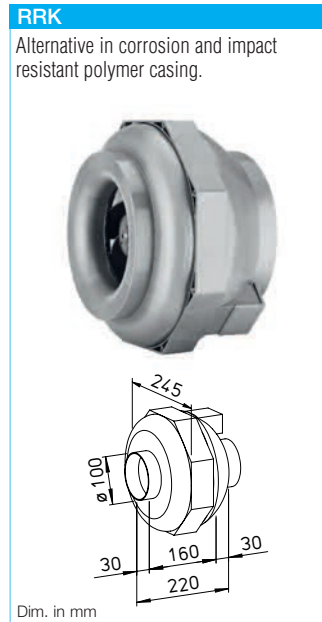

Specification RRK

- Casing**
All components made from corrosion and impact resistant polymer. Six built-in guide vanes also increase the level of efficiency. Colour: Silver-grey.
- Speed control**
From 0 – 100% by means of electronic controller or step transformer (see table).
- Electrical connection**
Terminal box (IP 54) located on outer casing.
- Impeller**
Centrifugal impeller with backward curved polymer blades. Directly mounted to motor and dynamically balanced as a unit. Low-noise, highly efficient.
- Protection class**
IP 44

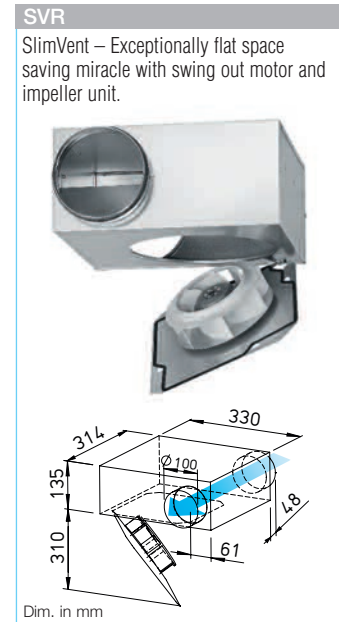

Specification SVR

- Casing**
Flat and robust casing from galvanised sheet steel. Spigots on intake and extract with twin-seal rubber gaskets fit into standard ducts. Particularly service-friendly (cleaning) through swing out motor and impeller unit without disassembly of system components. Space for the swing out facility must be considered.
- Speed control**
From 0 – 100% by means of electronic controller or step transformer (see table) or two-speed operation with Type DS 2/2 (accessories).
Type DS 2/2 Ref. no. 1267
- Electrical connection**
Terminal box (IP 54) fitted to running cable.
- Impeller**
Energy-saving centrifugal impeller with forward curved blades. Dynamically balanced for low noise operation.
- Protection class**
When installed in ducting IP 44.

Type	Ref. no.	Air flow volume (FID)	Nominal R.P.M.	Sound press. case breakout	Power consumption	Current		Wiring diagram	max. air flow temp.		Weight net approx.	Transformer-speed controller 5-step		Electronic* speed controller, stepless flush / surface	
						full load	control		full load	control		Type	Ref. no.	Type	Ref. no.
Type RR, 1 phase motor, 230 V, 50 Hz, capacitor motor, IP 44															
RR 100 A	5653	250	1730	36	41	0.18	0.18	508	60	60	2.9	TSW 0,3	3608	ESU 1 / ESA 1	0236 / 0238
RR 100 C ¹⁾	5654	330 ¹⁾ /220	2530 ¹⁾ /1655	42	62 ¹⁾ /40	0.27 ¹⁾ /0.18	0.27	934.1	60	60	2.9	TSW 0,3	3608	ESU 1 / ESA 1	0236 / 0238
Type RRK, 1 phase motor, 230 V, 50 Hz, capacitor motor, IP 44															
RRK 100	5973	260	2250	45	33	0.14	0.14	508	70	60	2.4	TSW 0,3	3608	ESU 1 / ESA 1	0236 / 0238
Type SVR, 1 phase motor, 230 V, 50 Hz, capacitor motor, IP 33															
SVR 100 C ²⁾	2658	310/245 ²⁾	2600/1940 ²⁾	45/40 ²⁾	58/40 ²⁾	0.25/0.18 ²⁾	0.23	934.1	60	60	4.8	TSW 1,5	1495	ESU 1 / ESA 1	0236 / 0238

¹⁾ Type with high speed; standard with additional energy-saving speed level (see performance diagram).

²⁾ Values are related to the 2 speeds (see performance diagram).

* In noise relevant cases transformer controller must be provided. An electronic controller can trigger a distracting magnetisation noise.

RR 100 A

Frequency	Hz	Total	125	250	500	1k	2k	4k	8k
L _{WA} Case breakout		dB(A)	43	21	33	35	39	37	31
L _{WA} Intake		dB(A)	66	56	64	60	58	52	45

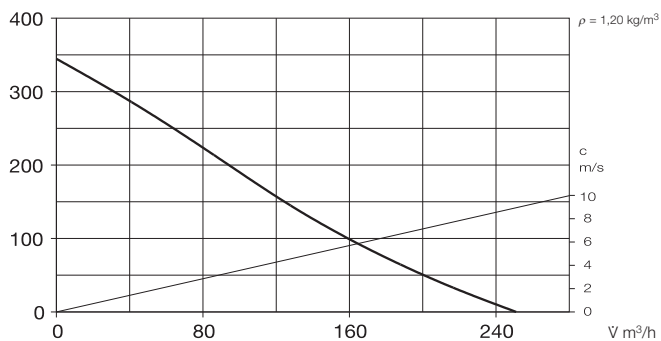

RR 100 C

Frequency	Hz	Total	125	250	500	1k	2k	4k	8k
L _{WA} Case breakout		dB(A)	49	23	40	40	44	42	38
L _{WA} Intake		dB(A)	70	61	66	65	65	59	52

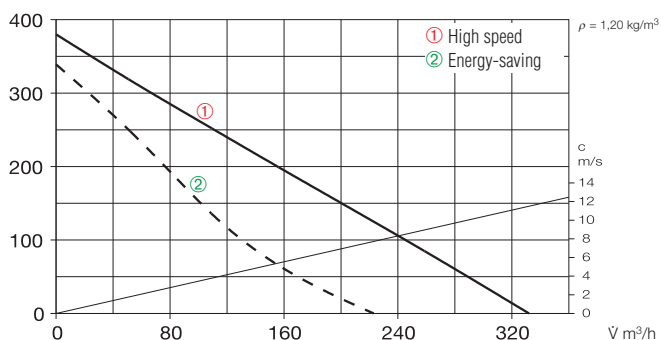

RRK 100

Frequency	Hz	Total	125	250	500	1k	2k	4k	8k
L _{WA} Case breakout		dB(A)	52	37	45	45	48	46	28
L _{WA} Intake		dB(A)	61	39	51	58	55	53	38

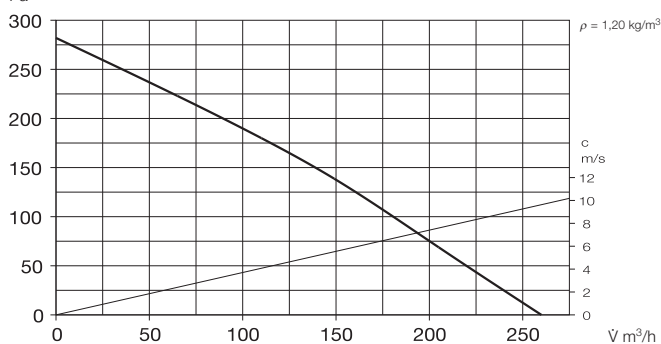

SVR 100 C

Frequency	Hz	Total	125	250	500	1k	2k	4k	8k
L _{WA} Case breakout		dB(A)	53	37	50	49	44	41	35
L _{WA} Intake		dB(A)	67	60	61	64	57	55	49
L _{WA} Exhaust		dB(A)	70	60	63	66	64	60	54

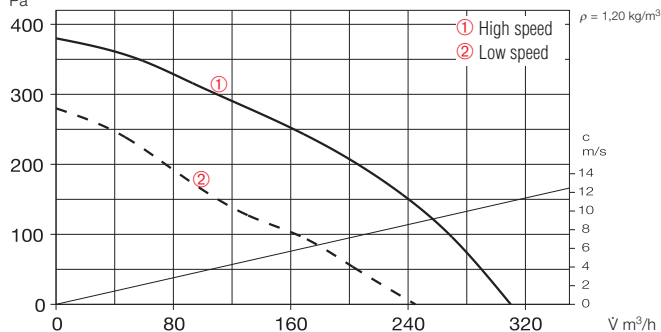

Accessories

Pipe clamp connectors

Type BM 100 Ref. no. 5075
A quick-fix method for connecting fans to ducting, reducing vibration transmission (1 kit = 2 pieces). When installing leave a little gap between fan and ducting.

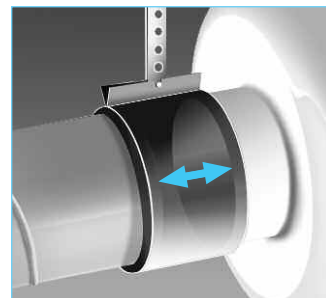

Mounting feet for RR

Type MK 4 Ref. no. 5824

Mounting feet for RRK

Type MK 1 Ref. no. 5821

Made from galvanised steel sheet.



Gravity shutter

Type VK 100 Ref. no. 0757

Automatic made from white polymer.

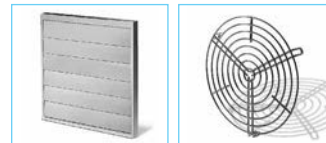

Rain repellent grille

Type G 100 Ref. no. 0796

Made from white polymer.



Guard

Type SGR 100 Ref. no. 5063

For intake and exhaust installation on fan, made from powder-coated steel wire.



Backdraught shutter

Type RSKK 100 Ref. no. 5106

Automatic, made from polymer.



Flexible attenuator

Type FSD 100 Ref. no. 0676

Spigotted aluminium attenuator with 50 mm insulation. Length 1 m.



Air filter box

LFBR 100 G4 Ref. no. 8576

LFBR 100 F7 Ref. no. 8530

Air filter with large surface area to be installed in-line with ducting.



Electric heater batteries

EHR-R 0,4/100 0,4 kW No. 8708

In galvanised steel sheet casing.



Temperature control system for electric heater batteries EHR-R

Type EHS Ref. no. 5002



Warm water heater battery

Type WHR 100 Ref. no. 9479

Compact heat exchanger for in-line installation.



Temperature control system for warm water heater battery

Type WHST 300 T38 No. 8817



For medium to smaller air flow volumes against high resistances.

Specifically made for in-duct installation. High pressure characteristic to overcome resistances of bends, filters etc. Universal in application for domestic, commercial and industrial purposes.

Special features

- Less space required and simple site installation of the compact in line design.
- Its simplicity reduces site costs.
- Supply and exhaust air spigots fit all standard circular duct sizes.
- Power adjustment by 100% variable speed control.
- Installation in any position.
- Wide range of accessories.
- Aerodynamically optimized casing design.

Common features

- Motor**
Closed, ball bearing-mounted external rotor motor with humidity protection, insulation class F, for continuous operation, maintenance free and interference-free.
- Motor protection**
Automatically switches off and on again after cooling due to built-in thermal contacts with the winding wired in series.
- Installation**
Can be mounted in any position – horizontal, vertical or diagonal – suitable for supply and extract ventilation by correct installation. To minimise the effective noise level it is recommended that the fan is installed as remote as possible from the ventilated space.

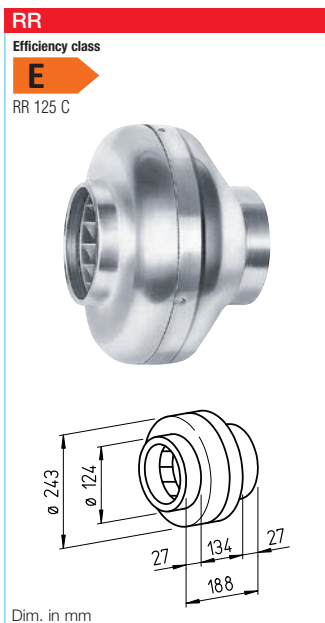

Dim. in mm

Specification RR

- Casing**
Robust casing from galvanised sheet steel for harsh operating conditions. Intake and exhaust Spigots on intake and exhaust fit standard ducts.
- Speed control**
From 0 – 100% by means of electronic controller or step transformer (see table) or two-speed operation with Type DS 2/2 (accessories).
Type DS 2/2 Ref. no. 1267
- Electrical connection**
Terminal box (IP 54) located on outer casing.
- Impeller**
Centrifugal impeller with backward curved polymer blades. Directly mounted to motor and dynamically balanced as a unit. Low-noise, highly efficient.
- Protection class**
When installed in intake and exhaust ducting and rainwater penetration is prevented, the fan is rated IP 44.

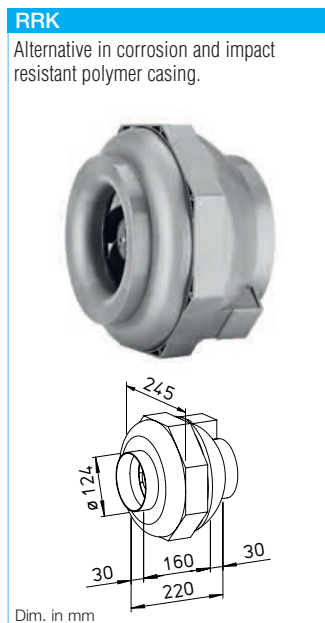

Dim. in mm

Specification RRK

- Casing**
All components made from corrosion and impact resistant polymer. Six built-in guide vanes also increase the level of efficiency. Colour: Silver-grey.
- Speed control**
From 0 – 100% by means of electronic controller or step transformer (see table).
- Electrical connection**
Terminal box (IP 54) located on outer casing.
- Impeller**
Centrifugal impeller with backward curved polymer blades. Directly mounted to motor and dynamically balanced as a unit. Low-noise, highly efficient.
- Protection class**
IP 44

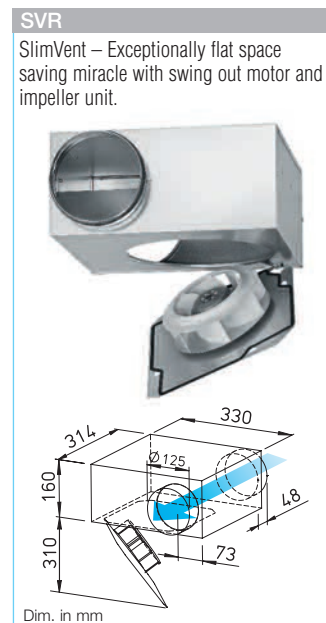

Dim. in mm

Specification SVR

- Casing**
Flat and robust casing from galvanised sheet steel. Spigots on intake and extract with twin-seal rubber gaskets fit into standard ducts. Particularly service-friendly (cleaning) through swing out motor and impeller unit without disassembly of system components. Space for the swing out facility must be considered.
- Speed control**
From 0 – 100% by means of electronic controller or step transformer (see table) or two-speed operation with Type DS 2/2 (accessories).
Type DS 2/2 Ref. no. 1267
- Electrical connection**
Terminal box (IP 54) fitted to running cable.
- Impeller**
Energy-saving centrifugal impeller with forward curved blades. Dynamically balanced for low noise operation.
- Protection class**
When installed in ducting IP 44.

Type	Ref. no.	Air flow volume (FID)	Nominal R.P.M.	Sound press. case breakout	Power consumption	Current full load	Current control	Wiring diagram	max. air flow temp. full load	max. air flow temp. control	Weight net approx.	Transformer-speed controller 5-step	Electronic* speed controller, stepless flush / surface		
		V m³/h	min⁻¹	db(A) in 1 m	W	A	A	No.	+°C	+°C	kg	Type	Ref. no.	Type	Ref. no.
Type RR, 1 phase motor, 230 V, 50 Hz, capacitor motor, IP 44															
RR 125 C ¹⁾	5655	480 ¹⁾ /310	2480 ¹⁾ /1655	42	62 ¹⁾ /40	0.27 ¹⁾ /0.18	0.27	934.1	70	70	2.9	TSW 0,3	3608	ESU 1 / ESA 1	0236 / 0238
Type RRK, 1 phase motor, 230 V, 50 Hz, capacitor motor, IP 44															
RRK 125	5974	330	2415	48	65	0,30	0.30	508	70	60	3.1	TSW 0,3	3608	ESU 1 / ESA 1	0236 / 0238
Type SVR, 1 phase motor, 230 V, 50 Hz, capacitor motor, IP 33															
SVR 125 B ²⁾	2671	400/290 ²⁾	2570/1810 ²⁾	46/38 ²⁾	59/41 ²⁾	0.26/0.18 ²⁾	0.24	934.1	60	60	5.1	TSW 1,5	1495	ESU 1 / ESA 1	0236 / 0238

¹⁾ Type with high speed; standard with additional energy-saving speed level (see performance diagram).

²⁾ Values are related to the 2 speeds (see performance diagram).

* In noise relevant cases transformer controller must be provided. An electronic controller can trigger a distracting magnetisation noise.

RR 125 C

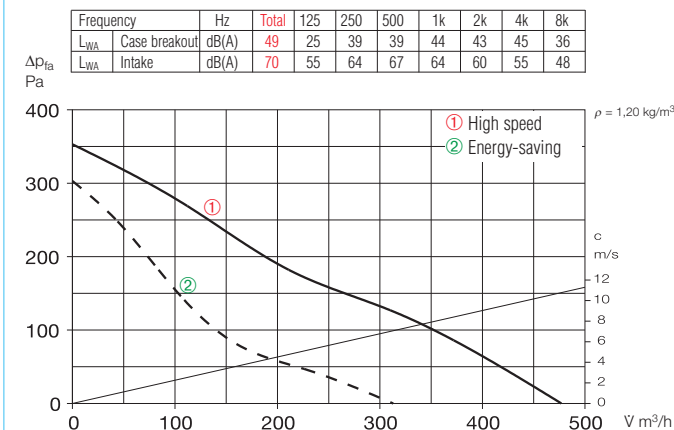

RRK 125

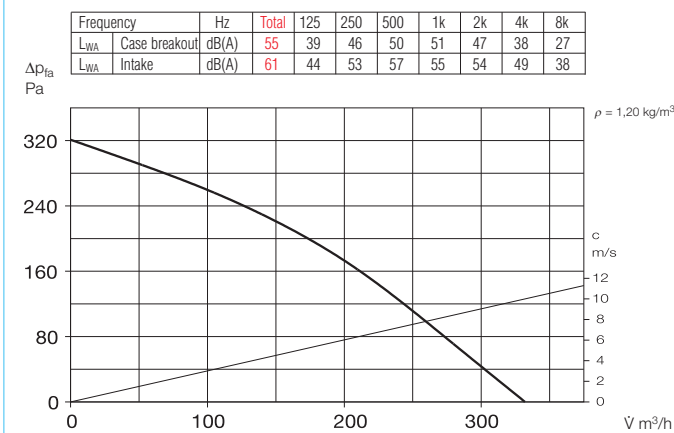

SVR 125 B

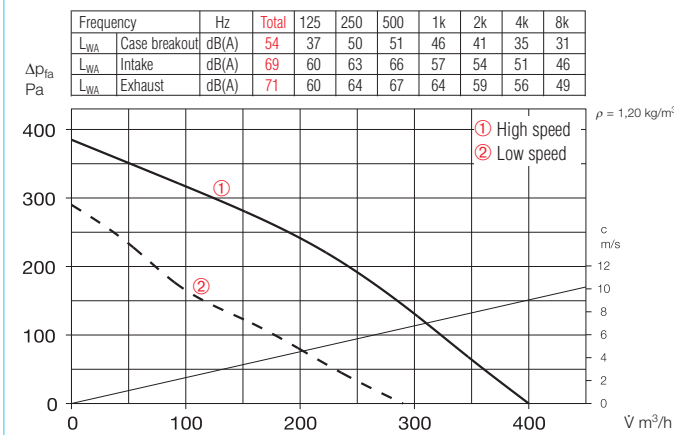

Sound levels

Total sound power levels and the spectrum figures in dB(A) are given for

- Sound level case breakout
- Sound level intake/exhaust

In addition, the case breakout and intake air noise figures are given as sound pressure levels at 1 metre (free field conditions) in the technical data table (see left page).

Note

Page
Techn. description
Selection chart
Information for planning
Modular system

Accessory details

Page
Filters, heater batteries and attenuators
Temperature control systems for heater batteries
Flexible ventilation ducting, grilles, adaptors, roof terminations
Poppet valves
Speed controllers and switches

Accessories

Pipe clamp connectors

Type BM 125 Ref. no. 5076
A quick-fix method for connecting fans to ducting, reducing vibration transmission (1 kit = 2 pieces). When installing leave a little gap between fan and ducting.

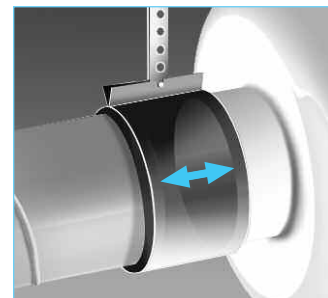

Mounting feet for RR

Type MK 4 Ref. no. 5824

Mounting feet for RRK

Type MK 1 Ref. no. 5821

Made from galvanised steel sheet.



Gravity shutter

Type VK 125 Ref. no. 0857

Automatic made from white polymer.

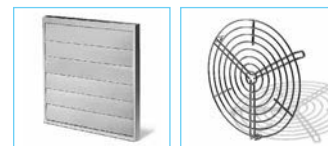

Rain repellent grille

Type G 160 Ref. no. 0893

Made from white polymer.



Guard

Type SGR 125 Ref. no. 5064

For intake and exhaust installation on fan, made from powder-coated steel wire.



Backdraught shutter

Type RSKK 125 Ref. no. 5107

Automatic, made from polymer.



Flexible attenuator

Type FSD 125 Ref. no. 0677

Spigotted aluminium attenuator with 50 mm insulation. Length 1 m.



Air filter box

LFBR 125 G4 Ref. no. 8577

LFBR 125 F7 Ref. no. 8531

Air filter with large surface area to be installed in-line with ducting.



Electric heater batteries

EHR-R 0,8/125 0,8 kW No. 8709

EHR-R 1,2/125 1,2 kW No. 9433

- with integrated temp. control

EHR-R 0,8/125 TR 0,8 kW No. 5293

Room or duct sensor required (TFK/TFR, accessory).



Temperature control system for electric heater batteries EHR-R

Type EHS Ref. no. 5002



Warm water heater battery

Type WHR 125 Ref. no. 9480

Compact heat exchanger for in-line installation.



Temperature control system for warm water heater battery

Type WHST 300 T38 No. 8817



For medium to smaller air flow volumes against high resistances.

Specifically made for in-duct installation. High pressure characteristic to overcome resistances of bends, filters etc. Universal in application for domestic, commercial and industrial purposes.

Special features

- Less space required and simple site installation of the compact in line design.
- Its simplicity reduces site costs.
- Supply and exhaust air spigots fit all standard circular duct sizes.
- Power adjustment by 100% variable speed control.
- Installation in any position.
- Wide range of accessories.
- Aerodynamically optimized casing design.

Common features

- Motor**
Closed, ball bearing-mounted external rotor motor with humidity protection, insulation class F, for continuous operation, maintenance free and interference-free.
- Motor protection**
Automatically switches off and on again after cooling due to built-in thermal contacts with the winding wired in series.
- Installation**
Can be mounted in any position – horizontal, vertical or diagonal – suitable for supply and extract ventilation by correct installation. To minimise the effective noise level it is recommended that the fan is installed as remote as possible from the ventilated space.
- Sound levels**
See page 333.

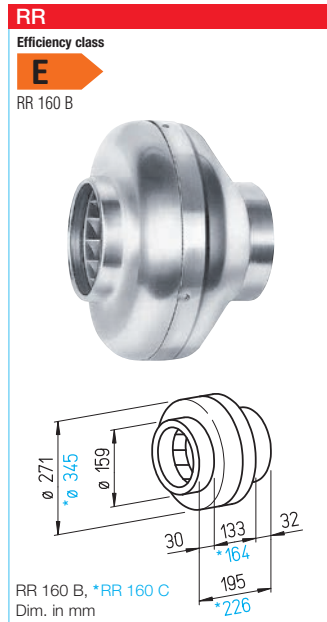

Specification RR

- Casing**
Robust casing from galvanised sheet steel for harsh operating conditions. Intake and exhaust Spigots on intake and exhaust fit standard ducts.
- Speed control**
From 0 – 100% by means of electronic controller or step transformer (see table) or two-speed operation with Type DS 2/2 (accessories).
Type DS 2/2 Ref. no. 1267
- Electrical connection**
Terminal box (IP 54) located on outer casing.
- Impeller**
Centrifugal impeller with backward curved polymer blades. Directly mounted to motor and dynamically balanced as a unit. Low-noise, highly efficient.
- Protection class**
When installed in intake and exhaust ducting and rainwater penetration is prevented, the fan is rated IP 44.

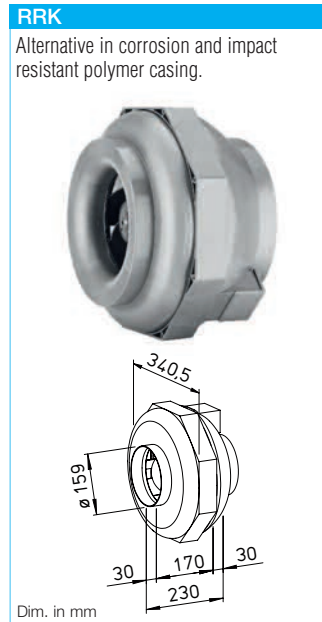

Specification RRK

- Casing**
All components made from corrosion and impact resistant polymer. Six built-in guide vanes also increase the level of efficiency. Colour: Silver-grey.
- Speed control**
From 0 – 100% by means of electronic controller or step transformer (see table).
- Electrical connection**
Terminal box (IP 54) located on outer casing.
- Impeller**
Centrifugal impeller with backward curved polymer blades. Directly mounted to motor and dynamically balanced as a unit. Low-noise, highly efficient.
- Protection class**
IP 44

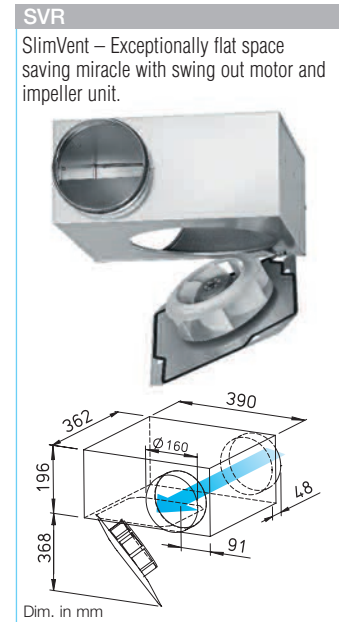

Specification SVR

- Casing**
Flat and robust casing from galvanised sheet steel. Spigots on intake and extract with twin-seal rubber gaskets fit into standard ducts. Particularly service-friendly (cleaning) through swing out motor and impeller unit without disassembly of system components. Space for the swing out facility must be considered.
- Speed control**
From 0 – 100% by means of electronic controller or step transformer (see table) or two-speed operation with Type DS 2/2 (accessories).
Type DS 2/2 Ref. no. 1267
- Electrical connection**
Terminal box (IP 54) fitted to running cable.
- Impeller**
Energy-saving centrifugal impeller with forward curved blades. Dynamically balanced for low noise operation.
- Protection class**
When installed in ducting IP 44.

Type	Ref. no.	Air flow volume (FID)	Nominal R.P.M.	Sound press. case breakout	Power consumption	Current		Wiring diagram	max. air flow temp.		Weight net approx.	Transformer-speed controller 5-step		Electronic* speed controller, stepless flush / surface	
						full load	control		full load	control		Type	Ref. no.	Type	Ref. no.
Type RR, 1 phase motor, 230 V, 50 Hz, capacitor motor, IP 44															
RR 160 B ¹⁾	5656	530 ¹⁾ /370	2540 ¹⁾ /1695	42	62 ¹⁾ /40	0.27 ¹⁾ /0.18	0.27	934.1	60	60	3.2	TSW 0,3	3608	ESU 1 / ESA 1	0236 / 0238
RR 160 C ¹⁾	5657	870 ¹⁾ /610	2480 ¹⁾ /1580	49	101 ¹⁾ /64	0.44 ¹⁾ /0.28	0.44	934.1	65	65	4.3	TSW 1,5	1495	ESU 1 / ESA 1	0236 / 0238
Type RRK, 1 phase motor, 230 V, 50 Hz, 1 phase motor, IP 44															
RRK 160	5976	430	2400	46	70	0.30	0.30	508	70	50	3.4	TSW 0,3	3608	ESU 1 / ESA 1	0236 / 0238
Type SVR, 1 phase motor, 230 V, 50 Hz, 1 phase motor, IP 33															
SVR 160 K ²⁾	2672	450/310 ²⁾	2550/1740 ²⁾	45/37 ²⁾	61/42 ²⁾	0.26/0.19 ²⁾	0.25	934.1	60	60	6.7	TSW 1,5	1495	ESU 1 / ESA 1	0236 / 0238

¹⁾ Type with high speed; standard with additional energy-saving speed level (see performance diagram).

²⁾ Values are related to the 2 speeds (see performance diagram).

* In noise relevant cases transformer controller must be provided. An electronic controller can trigger a distracting magnetisation noise.

RR 160 B

Frequency	Hz	Total	125	250	500	1k	2k	4k	8k
L _{WA} Case breakout		dB(A) 49	24	39	40	45	44	44	32
L _{WA} Intake		dB(A) 69	54	64	65	63	58	53	48

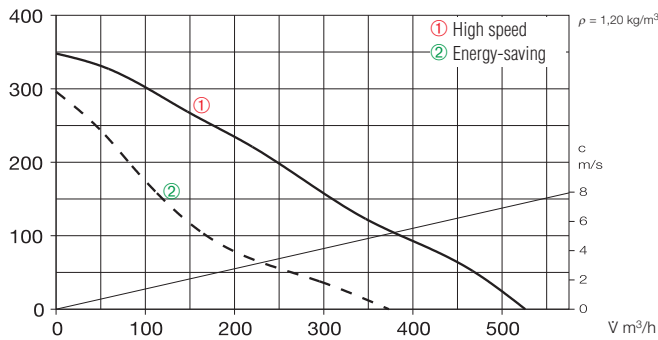

RR 160 C

Frequency	Hz	Total	125	250	500	1k	2k	4k	8k
L _{WA} Case breakout		dB(A) 56	34	42	49	54	47	48	35
L _{WA} Intake		dB(A) 73	60	64	68	69	64	64	54

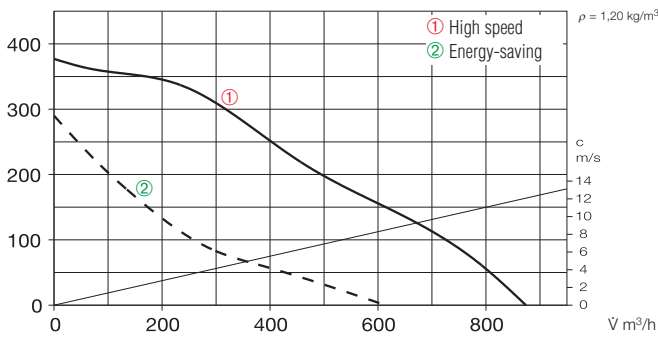

RRK 160

Frequency	Hz	Total	125	250	500	1k	2k	4k	8k
L _{WA} Case breakout		dB(A) 53	31	40	47	49	47	38	26
L _{WA} Intake		dB(A) 59	42	50	53	54	52	49	38

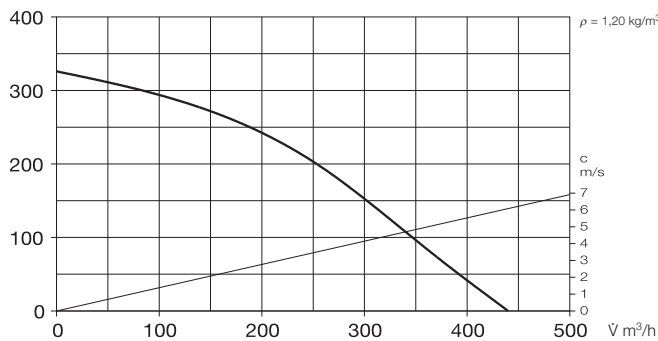

SVR 160 K

Frequency	Hz	Total	125	250	500	1k	2k	4k	8k
L _{WA} Case breakout		dB(A) 53	39	48	50	41	39	34	31
L _{WA} Intake		dB(A) 68	59	65	62	57	51	52	45
L _{WA} Exhaust		dB(A) 70	59	65	66	60	56	55	47

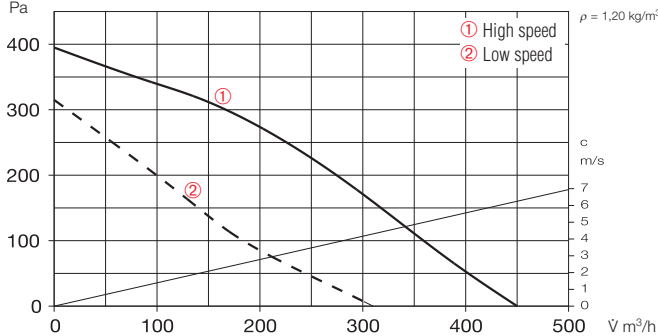

Accessories

Pipe clamp connectors

Type BM 160 Ref. no. 5077
A quick-fix method for connecting fans to ducting, reducing vibration transmission (1 kit = 2 pieces). When installing leave a little gap between fan and ducting.

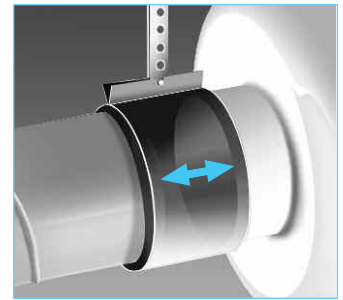

Mounting feet for RR

Type MK 4 Ref. no. 5824

Mounting feet for RRK

Type MK 2 Ref. no. 5822

Made from galvanised steel sheet.



Gravity shutter

Type VK 160 Ref. no. 0892

Automatic made from white polymer.

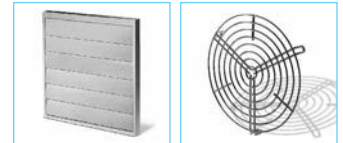

Rain repellent grille

Type G 160 Ref. no. 0893

Made from white polymer.

Guard

Type SGR 160 Ref. no. 5069

For intake and exhaust installation on fan, made from galvanised steel.



Backdraught shutter

Type RSK 160 Ref. no. 5669

Automatic, made from metal.



Flexible attenuator

Type FSD 160 Ref. no. 0678

Spigotted aluminium attenuator with 50 mm insulation. Length 1 m.



Air filter box

LFBR 160 G4 Ref. no. 8578

LFBR 160 F7 Ref. no. 8532

Air filter with large surface area to be installed in-line with ducting.



Electric heater batteries

EHR-R 1,2/160 1,2 kW No. 9434

EHR-R 2,4/160 2,4 kW No. 9435

EHR-R 5/160 5,0 kW No. 8710

– with integrated temp. control

EHR-R 2,4/160 TR 2,4 kW No. 5294

Room or duct sensor required (TFK/TFR, accessory).



Temperature control system for electric heater batteries EHR-R

Type EHS Ref. no. 5002

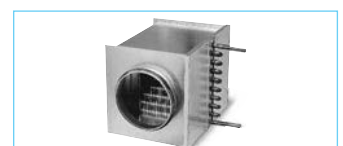

Warm water heater battery

Type WHR 160 Ref. no. 9481

Compact heat exchanger for in-line installation.



Temperature control system for warm water heater battery

Type WHST 300 T38 No. 8817

For medium to smaller air flow volumes against high resistances.

Specifically made for in-duct installation. High pressure characteristic to overcome resistances of bends, filters etc. Universal in application for domestic, commercial and industrial purposes.

Special features

- Less space required and simple site installation of the compact in line design.
- Its simplicity reduces site costs.
- Supply and exhaust air spigots fit all standard circular duct sizes.
- Power adjustment by 100% variable speed control.
- Installation in any position.
- Wide range of accessories.
- Aerodynamically optimized casing design.

Common features

- Motor**
Closed, ball bearing-mounted external rotor motor with humidity protection, insulation class F, for continuous operation, maintenance free and interference-free.
- Motor protection**
Automatically switches off and on again after cooling due to built-in thermal contacts with the winding wired in series.
- Installation**
Can be mounted in any position – horizontal, vertical or diagonal – suitable for supply and extract ventilation by correct installation. To minimise the effective noise level it is recommended that the fan is installed as remote as possible from the ventilated space.
- Sound levels**
See page 333.

RR

Market-leading series offering excellent value for money.
With energy saving mode as standard.

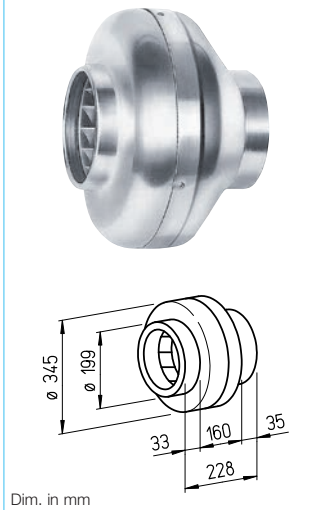

Specification RR

- Casing**
Robust casing from galvanised sheet steel for harsh operating conditions. Intake and exhaust Spigots on intake and exhaust fit standard ducts.
- Speed control**
From 0 – 100% by means of electronic controller or step transformer (see table).
Two-speed operation possible for Type RR 200 A using Type DS 2/2 (accessories).
Type DS 2/2 Ref. no. 1267
- Electrical connection**
Terminal box (IP 54) located on outer casing.
- Impeller**
Centrifugal impeller with backward curved polymer blades. Directly mounted to motor and dynamically balanced as a unit. Low-noise, highly efficient.
- Protection class**
When installed in intake and exhaust ducting and rainwater penetration is prevented, the fan is rated IP 44.

RRK

Alternative in corrosion and impact resistant polymer casing.

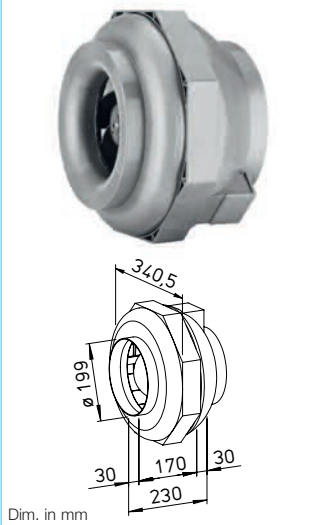

Specification RRK

- Casing**
All components made from corrosion and impact resistant polymer. Six built-in guide vanes also increase the level of efficiency. Colour: Silver-grey.
- Speed control**
From 0 – 100% by means of electronic controller or step transformer (see table).
- Electrical connection**
Terminal box (IP 54) located on outer casing.
- Impeller**
Centrifugal impeller with backward curved polymer blades. Directly mounted to motor and dynamically balanced as a unit. Low-noise, highly efficient.
- Protection class**
IP 44

SVR

SlimVent – Exceptionally flat space saving miracle with swing out motor and impeller unit.

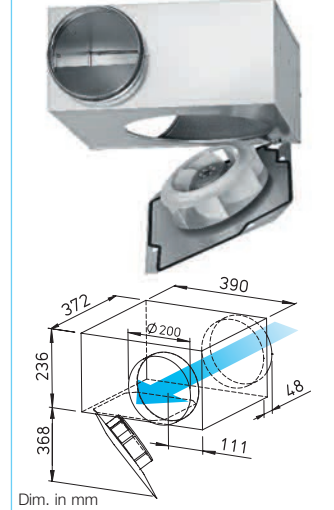

Specification SVR

- Casing**
Flat and robust casing from galvanised sheet steel. Spigots on intake and extract with twin-seal rubber gaskets fit into standard ducts. Particularly service-friendly (cleaning) through swing out motor and impeller unit without disassembly of system components. Space for the swing out facility must be considered.
- Speed control**
From 0 – 100% by means of electronic controller or step transformer (see table).
- Electrical connection**
Terminal box (IP 54) fitted to running cable.
- Impeller**
Energy-saving centrifugal impeller with forward curved blades. Dynamically balanced for low noise operation.
- Protection class**
When installed in ducting IP 44.

Type	Ref. no.	Air flow volume (FID)	Nominal R.P.M.	Sound press. case breakout	Power consumption	Current full load	Current control	Wiring diagram	max. air flow temp. full load	max. air flow temp. control	Weight net approx.	Transformer-speed controller 5-step	Electronic* speed controller, stepless flush / surface
		V m³/h	min⁻¹	db(A) in 1 m	W	A	A	No.	+°C	+°C	kg	Type Ref. no.	Type Ref. no.
Type RR, 1 phase motor, 230 V, 50 Hz, capacitor motor, IP 44 (Type RR 200 B, IP 33)													
RR 200 A ¹⁾	5658	930 ¹⁾ /760	2580 ¹⁾ /1830	47	115 ¹⁾ /85	0.51 ¹⁾ /0.39	0.51	934.1	60	60	4.6	TSW 1,5 1495	ESU 1 / ESA 1 0236 / 0238
RR 200 B	5659	980	2750	44	145	0.63	0.78	508	70	60	5.0	TSW 1,5 1495	ESU 1 / ESA 1 0236 / 0238
Type RRK, 1 phase motor, 230 V, 50 Hz, capacitor motor, IP 44													
RRK 200	5977	780	2395	56	115	0.50	0.50	508	60	50	3.6	TSW 1,5 1495	ESU 1 / ESA 1 0236 / 0238
Type SVR, 1 phase motor, 230 V, 50 Hz, capacitor motor, IP 33													
SVR 200 K	2673	980	2730	57	154	0.67	0.81	508	70	50	8.4	TSW 1,5 1495	ESU 1 / ESA 1 0236 / 0238

¹⁾ Type with high speed; standard with additional energy-saving speed level (see performance diagram).

* In noise relevant cases transformer controller must be provided. An electronic controller can trigger a distracting magnetisation noise.

RR 200 A

Frequency	Hz	Total	125	250	500	1k	2k	4k	8k
L _{WA} Case breakout		dB(A) 54	31	42	46	50	47	48	34
L _{WA} Intake		dB(A) 72	60	64	67	66	64	65	55

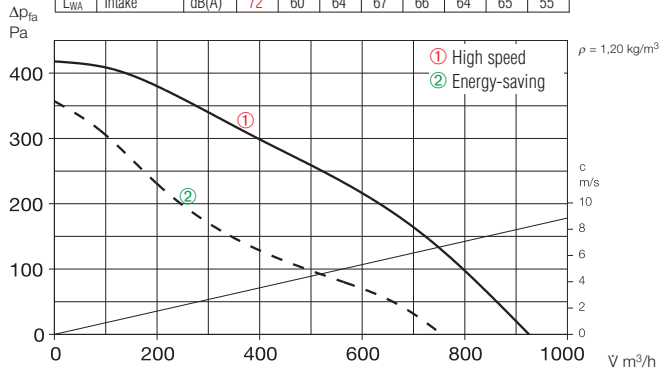

RR 200 B

Frequency	Hz	Total	125	250	500	1k	2k	4k	8k
L _{WA} Case breakout		dB(A) 52	34	41	46	48	44	44	35
L _{WA} Intake		dB(A) 74	62	67	69	66	63	62	57

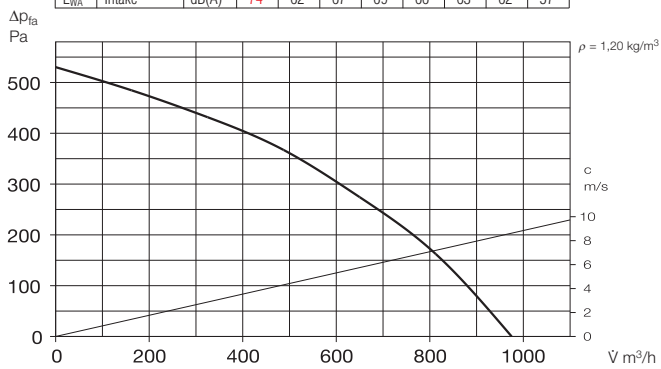

RRK 200

Frequency	Hz	Total	125	250	500	1k	2k	4k	8k
L _{WA} Case breakout		dB(A) 63	42	47	57	58	57	51	38
L _{WA} Intake		dB(A) 73	51	64	71	69	65	62	54

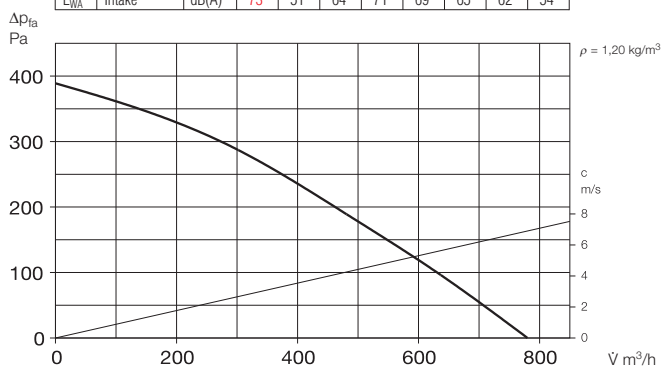

SVR 200 K

Frequency	Hz	Total	125	250	500	1k	2k	4k	8k
L _{WA} Case breakout		dB(A) 65	47	62	61	53	48	42	36
L _{WA} Intake		dB(A) 78	65	74	73	65	63	60	57
L _{WA} Exhaust		dB(A) 82	69	77	79	71	70	66	63

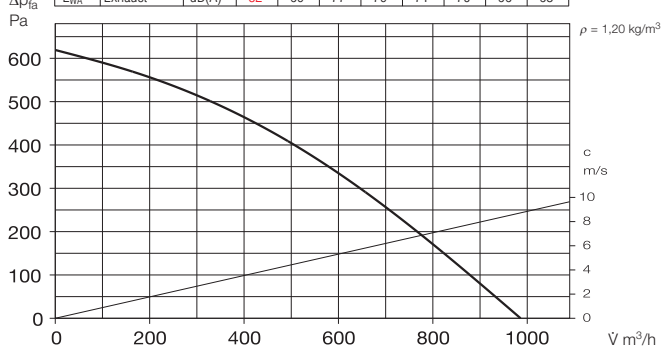

Accessories

Pipe clamp connectors

Type BM 200 Ref. no. 5078
A quick-fix method for connecting fans to ducting, reducing vibration transmission (1 kit = 2 pieces). When installing leave a little gap between fan and ducting.

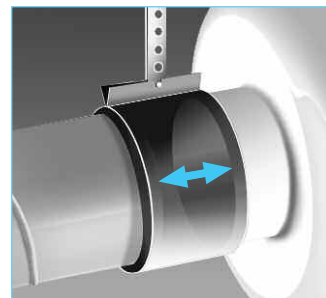

Mounting feet for RR

Type MK 4 Ref. no. 5824

Mounting feet for RRK

Type MK 2 Ref. no. 5822

Made from galvanised steel sheet.



Gravity shutter

Type VK 200 Ref. no. 0758

Made from polymer, light grey.

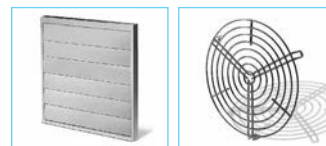

Rain repellent grille

Type RAG 200 Ref. no. 0750

Made from polymer, light grey.

Guard

Type SGR 200 Ref. no. 5066

For intake and exhaust installation on fan, made from galvanised steel.



Backdraught shutter

Type RSK 200 Ref. no. 5074

Automatic, made from metal.



Flexible attenuator

Type FSD 200 Ref. no. 0679

Spigotted aluminium attenuator with 50 mm insulation. Length 1 m.

Air filter box

LFBR 200 G4 Ref. no. 8579

LFBR 200 F7 Ref. no. 8533

Air filter with large surface area to be installed in-line with ducting.



Electric heater batteries

EHR-R 1,2/200 1,2 kW No. 9436

EHR-R 2/200 2,0 kW No. 9437

EHR-R 5/200 5,0 kW No. 8711

– with integrated temp. control

EHR-R 5/200 TR 5,0 kW No. 5295

Room or duct sensor required (TFK/TFR, accessory).



Temperature control system for electric heater batteries EHR-R

Type EHS Ref. no. 5002



Warm water heater battery

Type WHR 200 Ref. no. 9482

Compact heat exchanger for in-line installation.

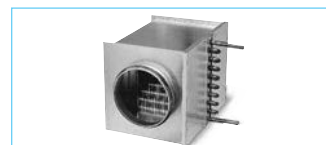

Temperature control system for warm water heater battery

Type WHST 300 T38 No. 8817



For medium to smaller air flow volumes against high resistances.

Specifically made for in-duct installation. High pressure characteristic to overcome resistances of bends, filters etc. Universal in application for domestic, commercial and industrial purposes.

Special features

- Less space required and simple site installation of the compact in line design.
- Its simplicity reduces site costs.
- Supply and exhaust air spigots fit all standard circular duct sizes.
- Power adjustment by 100% variable speed control.
- Installation in any position.
- Wide range of accessories.
- Aerodynamically optimized casing design.

Common features

- Motor**
Closed, ball bearing-mounted external rotor motor with humidity protection, insulation class F, for continuous operation, maintenance free and interference-free.
- Motor protection**
Automatically switches off and on again after cooling due to built-in thermal contacts with the winding wired in series.

RR

Market-leading series offering excellent value for money.
With energy saving mode as standard.

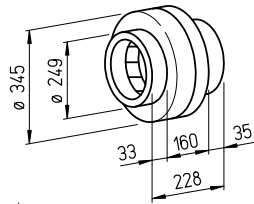

Dim. in mm

Specification RR

- Casing**
Robust casing from galvanised sheet steel for harsh operating conditions. Intake and exhaust Spigots on intake and exhaust fit standard ducts.
- Speed control**
From 0 – 100% by means of electronic controller or step transformer (see table).
Two-speed operation possible for Type RR 200 A using Type DS 2/2 (accessories).
Type DS 2/2 Ref. no. 1267
- Electrical connection**
Terminal box (IP 54) located on outer casing.
- Impeller**
Centrifugal impeller with backward curved polymer blades. Directly mounted to motor and dynamically balanced as a unit. Low-noise, highly efficient.
- Protection class**
When installed in intake and exhaust ducting and rainwater penetration is prevented, the fan is rated IP 44.

RRK

Alternative in corrosion and impact resistant polymer casing.

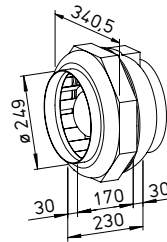

Dim. in mm

Specification RRK

- Casing**
All components made from corrosion and impact resistant polymer. Six built-in guide vanes also increase the level of efficiency. Colour: Silver-grey.
- Speed control**
From 0 – 100% by means of electronic controller or step transformer (see table).
- Electrical connection**
Terminal box (IP 54) located on outer casing.
- Impeller**
Centrifugal impeller with backward curved polymer blades. Directly mounted to motor and dynamically balanced as a unit. Low-noise, highly efficient.
- Protection class**
IP 44

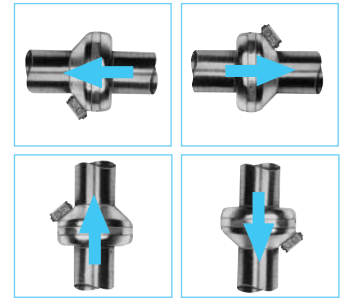
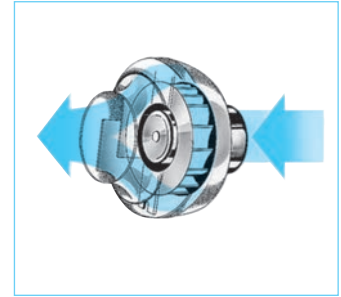

Installation

Can be mounted in any position – horizontal, vertical or diagonal – suitable for supply and extract ventilation by correct installation. To minimise the effective noise level it is recommended that the fan is installed as remote as possible from the ventilated space.

Type	Ref. no.	Air flow volume (FID)	Nominal R.P.M.	Sound press. case breakout	Power consumption	Current full load	Current control	Wiring diagram	max. air flow temp. full load	temp. control	Weight net approx.	Transformer-speed controller 5-step	Electronic* speed controller, stepless flush / surface		
		\dot{V} m ³ /h	min ⁻¹	db(A) in 1 m	W	A	A	No.	+°C	+°C	kg	Type	Ref. no.	Type	Ref. no.
Type RR, 1 phase motor, 230 V, 50 Hz, capacitor motor, IP 44 (Type RR 250 C, IP 33)															
RR 250 A ¹⁾	5652	886 ¹⁾ /740	2580 ¹⁾ /1910	46	115 ¹⁾ /83	0.50 ¹⁾ /0.38	0.50	934.1	60	60	4.6	TSW 1,5	1495	ESU 1 / ESA 1	0236 / 0238
RR 250 C	5660	970	2750	45	145	0.63	0.78	508	70	60	5.0	TSW 1,5	1495	ESU 1 / ESA 1	0236 / 0238
Type RRK, 1 phase motor, 230 V, 50 Hz, capacitor motor, IP 44															
RRK 250	5978	912	2450	53	115	0.50	0.50	508	50	40	3.9	TSW 1,5	1495	ESU 1 / ESA 1	0236 / 0238

¹⁾ Type with high speed; standard with additional energy-saving speed level (see performance diagram).

* In noise relevant cases transformer controller must be provided. An electronic controller can trigger a distracting magnetisation noise.

RR 250 A

Frequency	Hz	Total	125	250	500	1k	2k	4k	8k	
L _{WA} Case breakout		dB(A)	54	30	34	47	52	47	44	38
L _{WA} Intake		dB(A)	74	60	67	67	69	68	64	55

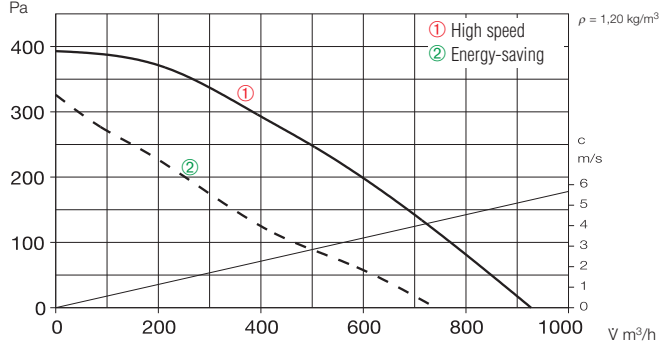

RR 250 C

Frequency	Hz	Total	125	250	500	1k	2k	4k	8k	
L _{WA} Case breakout		dB(A)	53	31	42	46	49	46	43	38
L _{WA} Intake		dB(A)	75	60	67	67	70	66	64	66

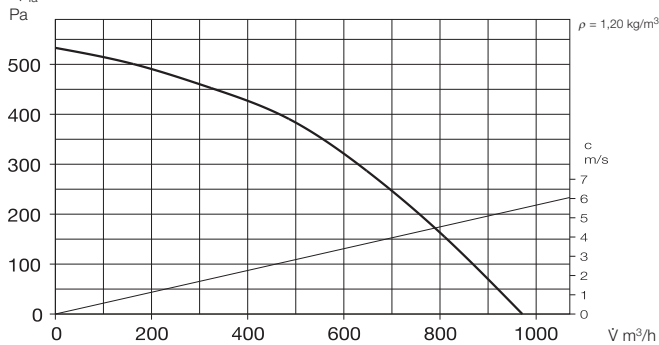

RRK 250

Frequency	Hz	Total	125	250	500	1k	2k	4k	8k	
L _{WA} Case breakout		dB(A)	60	46	49	52	56	55	51	41
L _{WA} Intake		dB(A)	68	53	56	64	61	60	57	47

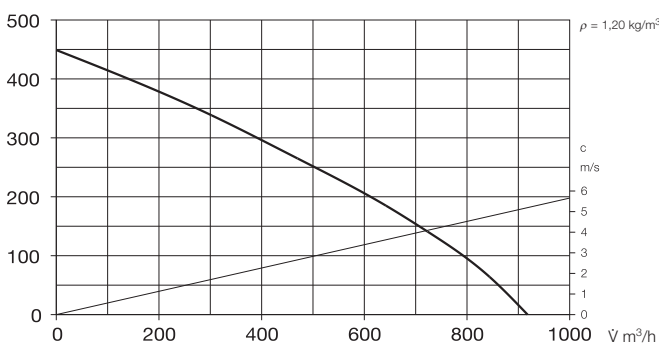

Sound levels

Total sound power levels and the spectrum figures in dB(A) are given for

- Sound level case breakout
- Sound level intake/exhaust

In addition, the case breakout and intake air noise figures are given as sound pressure levels at 1 metre (free field conditions) in the technical data table (see left page).

Note

	Page
Techn. description	296
Selection chart	297
Information for planning	10 on
Modular system	294

Accessory details

	Page
Filters, heater batteries and attenuators	421 on
Temperature control systems for heater batteries	427, 431 on
Flexible ventilation ducting, grilles, adaptors, roof terminations	487 on
Poppet valves	508 on
Speed controllers and switches	525 on

Accessories

Pipe clamp connectors

Type BM 250 Ref. no. 5079
A quick-fix method for connecting fans to ducting, reducing vibration transmission (1 kit = 2 pieces). When installing leave a little gap between fan and ducting.

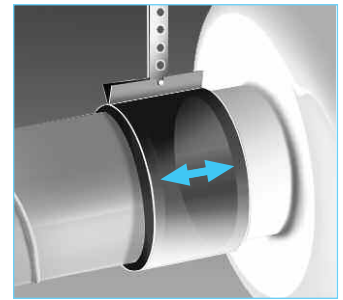

Mounting feet for RR

Type MK 4 Ref. no. 5824
Mounting feet for RRRK
Type MK 2 Ref. no. 5822
Made from galvanised steel sheet.



Gravity shutter

Type VK 250 Ref. no. 0759
Automatic made from polymer, light grey.

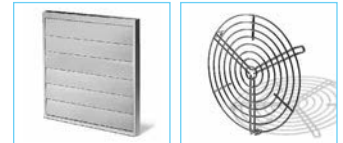

Rain repellent grille

Type RAG 250 Ref. no. 0751
Made from polymer, light grey.



Guard

Type SGR 250 Ref. no. 5067
For intake and exhaust installation on fan, made from galvanised steel.



Backdraught shutter

Type RSK 250 Ref. no. 5673
Automatic, made from metal.



Flexible attenuator

Type FSD 250 Ref. no. 0680
Spigotted aluminium attenuator with 50 mm insulation. Length 1 m.



Air filter box

LFBR 250 G4 Ref. no. 8580
LFBR 250 F7 Ref. no. 8534
Air filter with large surface area to be installed in-line with ducting.



Electric heater batteries

EHR-R 6/250 6,0 kW No. 8712
– with integrated temp. control
EHR-R 6/250 TR 6,0 kW No. 5296
Room or duct sensor required (TFK/TFR, accessory).



Temperature control system for electric heater batteries EHR-R

Type EHS Ref. no. 5002



Warm water heater battery

Type WHR 250 Ref. no. 9483
Compact heat exchanger for in-line installation.

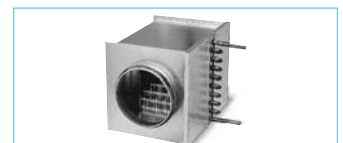

Temperature control system for warm water heater battery

Type WHS HE Ref. no. 8319



For medium to smaller air flow volumes against high resistances.

Specifically made for in-duct installation. High pressure characteristic to overcome resistances of bends, filters etc. Universal in application for domestic, commercial and industrial purposes.

Special features

- Less space required and simple site installation of the compact in line design.
- Its simplicity reduces site costs.
- Supply and exhaust air spigots fit all standard circular duct sizes.
- Power adjustment by 100% variable speed control.
- Installation in any position.
- Wide range of accessories.
- Aerodynamically optimized casing design.

Common features

- Motor**
Closed, ball bearing-mounted external rotor motor with humidity protection, insulation class F, for continuous operation, maintenance free and interference-free.
- Motor protection**
Automatically switches off and on again after cooling due to built-in thermal contacts with the winding wired in series.

RR

Market-leading series offering excellent value for money.

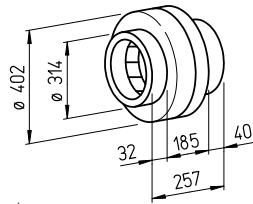

Dim. in mm

Specification RR

- Casing**
Robust casing from galvanised sheet steel for harsh operating conditions. Intake and exhaust Spigots on intake and exhaust fit standard ducts.
- Speed control**
From 0 – 100% by means of electronic controller or step transformer (see table).
- Electrical connection**
Terminal box (IP 54) located on outer casing.
- Impeller**
Centrifugal impeller with backward curved polymer blades. Directly mounted to motor and dynamically balanced as a unit. Low-noise, highly efficient.
- Protection class**
When installed in intake and exhaust ducting and rainwater penetration is prevented, the fan is rated IP 44.

RRK

Alternative in corrosion and impact resistant polymer casing.

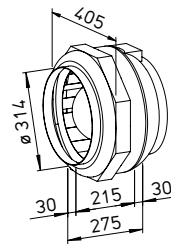

Dim. in mm

Specification RRK

- Casing**
All components made from corrosion and impact resistant polymer. Six built-in guide vanes also increase the level of efficiency. Colour: Silver-grey.
- Electrical connection**
Terminal box (IP 54) located on outer casing.
- Speed control**
From 0 – 100% by means of electronic controller or step transformer (see table).
- Impeller**
Centrifugal impeller with backward curved polymer blades. Directly mounted to motor and dynamically balanced as a unit. Low-noise, highly efficient.
- Protection class**
IP 44

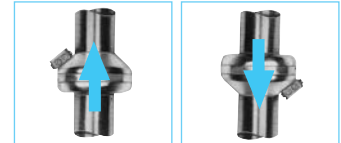
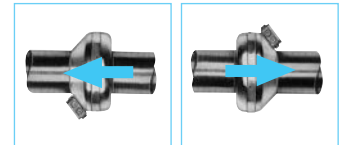
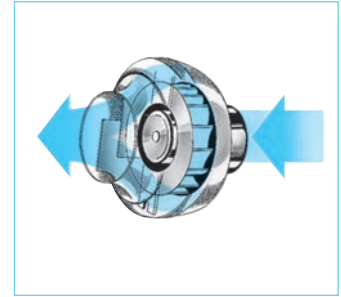

Installation

Can be mounted in any position – horizontal, vertical or diagonal – suitable for supply and extract ventilation by correct installation. To minimise the effective noise level it is recommended that the fan is installed as remote as possible from the ventilated space.

Type	Ref. no.	Air flow volume (FID)	Nominal R.P.M.	Sound press. case breakout	Power consumption	Current control		Wiring diagram	max. air flow temp. control		Weight net approx.	Transformer-speed controller 5-step		Electronic* speed controller, stepless flush / surface	
						full load	control		full load	control		Type	Ref. no.	Type	Ref. no.
		\dot{V} m ³ /h	min ⁻¹	db(A) in 1 m	W	A	A	No.	+°C	+°C	kg	Type	Ref. no.	Type	Ref. no.
Type RR, 1 phase motor, 230 V, 50 Hz, capacitor motor, IP 44															
RR 315	5920	1260	2660	46	200	0.87	0.97	508	70	60	6.1	TSW 1,5	1495	ESU 3 / ESA 3	0237 / 0239
Type RRK, 1 phase motor, 230 V, 50 Hz, capacitor motor, IP 44															
RRK 315	5979	1060	2690	48	170	0.75	0.97	508	70	60	5.7	TSW 1,5	1495	ESU 3 / ESA 3	0237 / 0239

* In noise relevant cases transformer controller must be provided. An electronic controller can trigger a distracting magnetisation noise.

RR 315

Frequency	Hz	Total	125	250	500	1k	2k	4k	8k	
L _{WA} Case breakout		dB(A)	54	40	45	46	48	49	46	37
L _{WA} Intake		dB(A)	76	58	65	66	67	70	70	64

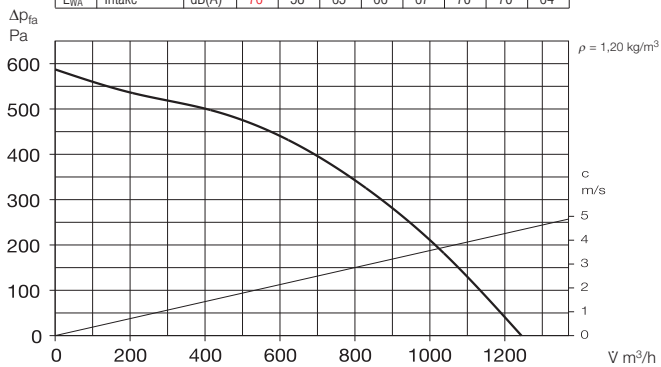

RRK 315

Frequency	Hz	Total	125	250	500	1k	2k	4k	8k	
L _{WA} Case breakout		dB(A)	55	40	45	50	50	47	43	34
L _{WA} Intake		dB(A)	72	45	63	64	68	64	63	57

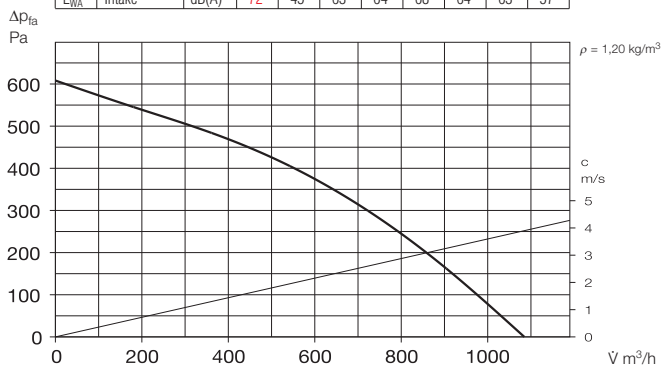

Sound levels

Total sound power levels and the spectrum figures in dB(A) are given for

- Sound level case breakout
- Sound level intake/exhaust

In addition, the case breakout and intake air noise figures are given as sound pressure levels at 1 metre (free field conditions) in the technical data table (see left page).

Note

Page
Techn. description
Selection chart
Information for planning
Modular system

Accessory details

Page
Filters, heater batteries and attenuators
Temperature control systems for heater batteries
Flexible ventilation ducting, grilles, adaptors, roof terminations
Poppet valves
Speed controllers and switches

Accessories

Pipe clamp connectors

Type BM 315 Ref. no. 5080
A quick-fix method for connecting fans to ducting, reducing vibration transmission (1 kit = 2 pieces). When installing leave a little gap between fan and ducting.

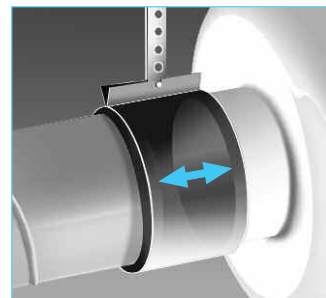

Mounting feet for RR

Type MK 4 Ref. no. 5824

Mounting feet for RRK

Type MK 3 Ref. no. 5823
Made from galvanised steel sheet.



Gravity shutter

Type VK 315 Ref. no. 0760

Automatic made from polymer, light grey.

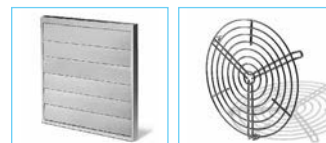

Rain repellent grille

Type RAG 315 Ref. no. 0752

Made from polymer, light grey.



Guard

Type SGR 315 Ref. no. 5068

For intake and exhaust installation on fan, made from galvanised steel.



Backdraught shutter

Type RSK 315 Ref. no. 5674

Automatic, made from metal.



Flexible attenuator

Type FSD 315 Ref. no. 0681

Spigotted aluminium attenuator with 50 mm insulation. Length 1 m.



Air filter box

LFBR 315 G4 Ref. no. 8581

LFBR 315 F7 Ref. no. 8535

Air filter with large surface area to be installed in-line with ducting.



Electric heater batteries

EHR-R 6/315 6,0 kW No. 8713

– with integrated temp. control

EHR-R 6/315 TR 6,0 kW No. 5301

Room or duct sensor required (TFK/TFR, accessory).



Temperature control system for electric heater batteries EHR-R

Type EHS Ref. no. 5002



Warm water heater battery

Type WHR 315 Ref. no. 9484

Compact heat exchanger for in-line installation.



Temperature control system for warm water heater battery

Type WHS HE Ref. no. 8319



Acoustic Line from Helios. Ventilation doesn't get any quieter.

LOW-NOISE



Acoustic Line in-line fans guarantee the lowest possible sound level for the intake side and casing-borne noise. They are suitable for use in the residential, commercial and industrial sectors and equipped with impellers capable of high-performance that are simultaneously energy-efficient and quiet impellers. Casing designed for sound insulation with 50 mm thick mineral wool lining also ensure particularly quiet operation.

HELIOS SILENTBOX®



Ø 125 to 400 mm
V̇ = 230 – 4760 m³/h

The Helios SilentBox® is the clever solution for exhaust air and outdoor air ventilation systems with specific requirements on the noise level. With a sound-insulated casing for almost silent operation. The removable casing cover and the removable fan unit are ideal when it comes to maintenance and cleaning.

HELIOS SLIMVENT



Ø 125 to 315 mm
V̇ = 400 – 1630 m³/h

The flat SlimVent models are only slightly larger than the duct diameter and allow for simple, space-saving installation in any chosen location. The high pressure allows for longer stretches of ducting and overcomes further system resistance. Minimal noise levels are achieved thanks to the complete mineral wool lining.



In-line fans

Acoustic Line

Energy-efficient
EC version

344^{on}

Acoustic Line

Standard AC types

358^{on}

SilentBox® SB EC



Virtually noise-free with high air flow volumes against high resistances. Ideal for maintenance and cleaning.

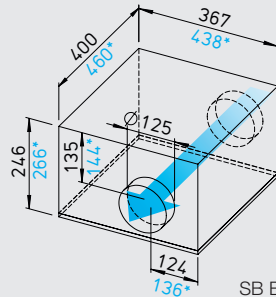

Dim. in mm SB EC 125 A, *SB EC 125 B

SlimVent SVS EC



Ultra low profile. Ideal for applications with limited installation space. With sound-insulating mineral wool lining for particularly noise-free operation.

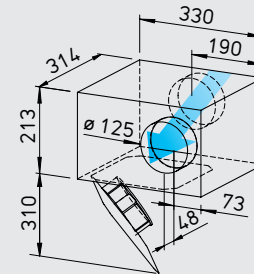

Dim. in mm

Similarities SilentBox® SB EC and SlimVent SVS EC

Installation

Installation in any position without restriction – horizontally, vertically or pitched – suitable for intake or extract. Mounting bracket included in delivery.

Motor

Energy saving, speed controllable EC-external rotor motors with highest efficiency, protection to IP 44 (SB EC 125 A IP 54). With ball bearings, maintenance-free and interference-free. Dynamically balanced for low noise operation.

Speed control

Stepless speed control with potentiometer or stepless speed control with universal control system (see table). Duties at different speeds are exemplarily given in the performance curve.

Motor protection

Integrated electronic temperature monitoring for EC-motor and electronics.

Sound levels

See page 351.

Specification SilentBox® EC

Casing

Like an internal attenuator. Acoustically lined with abrasive resistant 50 mm thick mineral fibreboard. Four quick release clamps permit easy access to the impeller set. Motor-impeller unit can be pulled out, the pull-out range must be considered. Spigots on intake and exhaust fit twin-seal rubber gaskets fit standard ducts. All parts manufactured from galvanised sheet steel.

Impeller

With backward curved impeller. Inflow via inlet cone. SB EC 125 A forward curved

impeller in aerodynamically optimised volute casing, galvanised sheet steel.

Electrical connection

Terminal box (IP 54) mounted on running cable.

Protection class

With a connected pipe system IP 44 (SB EC 125 A IP 54).

Specification SlimVent SVS EC

Casing

Extremely flat casing in longer design with more than 50 mm thick sound-absorbing mineral wool lining and glass fibre surface. The acoustic box which is placed in front of the fan reduces the sound level for the intake significantly. The sound level of the case breakout is reduced to a smaller extent (see sound levels in the tables above the performance curves).

The swing out motor and impeller unit permits maintenance

and cleaning without disassembly of system components. The swing-out range of the motor-impeller unit must be considered.

Impeller

Energy-saving centrifugal impeller with backward curved blades from high quality polymer.

Electrical connection

Terminal box (IP 54) mounted on running cable.

Protection class

With a connected pipe system IP 44.

Type	Ref. no.	Connection Ø	Air flow volume (FID)	R.P.M.	Sound press. case breakout	Motor power	Current	Wiring diagram	max. air flow temperature	Weight net approx.	Universal control system		Speed-potentiometer flush		Speed-potentiometer surface	
											Type	Ref. no.	Type	Ref. no.	Type	Ref. no.
Type SilentBox® SB EC, 1 ph. motor, 230 V, 50/60 Hz, EC motor, IP 54 (A), IP 44 (B)																
SB EC 125 A	6132	125	530	2790	43	0.12	1.00	979	60	10.0	EUR EC ¹⁾²⁾	1347	PU 10 ¹⁾	1734	PA 10 ¹⁾	1735
SB EC 125 B	9624	125	600	3680	45	0.12	0.93	979	60	12.0	EUR EC ¹⁾²⁾	1347	PU 10 ¹⁾	1734	PA 10 ¹⁾	1735
Type SVS EC, 1 ph. motor, 230 V, 50/60 Hz, EC motor, IP 44																
SVS EC 125	0016	125	590	3670	54	0.12	0.93	979	60	5.8	EUR EC ¹⁾²⁾	1347	PU 10 ¹⁾	1734	PA 10 ¹⁾	1735

1) Several EC fans can normally be connected. 2) alternative electronic differential pressure/temp. controller (EDR/ETR, No. 1437/1438) or three step speed controller (SU/SA, No. 4266/4267), see accessories.

SB EC 125 A

Frequency	Hz	Total	125	250	500	1k	2k	4k	8k
L _{WA} Case breakout	dB(A)	51	47	43	45	35	36	35	31
L _{WA} Intake	dB(A)	66	63	58	50	47	54	53	49
L _{WA} Exhaust	dB(A)	79	68	69	71	71	74	70	69

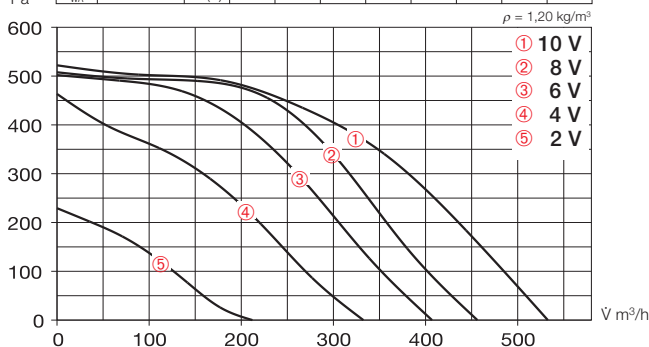

Free discharge						
Voltage V	n min ⁻¹	V̇ m³/h	P W	I A	Lp dB(A)	SFP kW/m²/s
10	2380	530	110	0,95	43	0,75
8	2070	460	75	0,66	41	0,59
6	1890	410	55	0,48	39	0,48
4	1560	330	35	0,31	35	0,38

SB EC 125 B

Frequency	Hz	Total	125	250	500	1k	2k	4k	8k
L _{WA} Case breakout	dB(A)	53	44	47	49	44	37	33	30
L _{WA} Intake	dB(A)	61	58	55	53	47	48	44	36
L _{WA} Exhaust	dB(A)	81	67	71	77	74	74	69	63

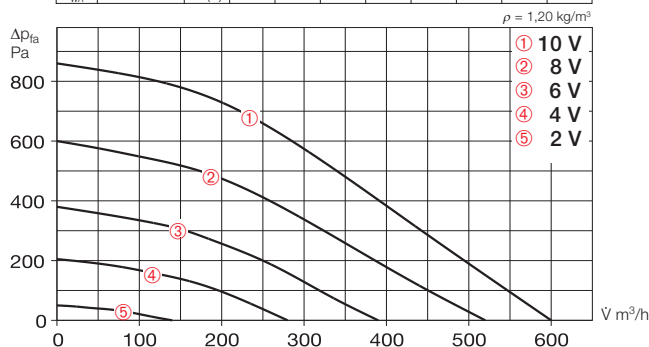

Free discharge						
Voltage V	n min ⁻¹	V̇ m³/h	P W	I A	Lp dB(A)	SFP kW/m²/s
10	3720	600	115	0,91	45	0,68
8	3140	520	70	0,57	42	0,48
6	2500	390	40	0,32	38	0,37
4	1850	280	20	0,15	32	0,26

SVS EC 125

Frequency	Hz	Total	125	250	500	1k	2k	4k	8k
L _{WA} Case breakout	dB(A)	62	47	51	60	54	52	46	39
L _{WA} Intake	dB(A)	69	64	65	62	55	55	55	45
L _{WA} Exhaust	dB(A)	81	68	70	76	75	73	71	61

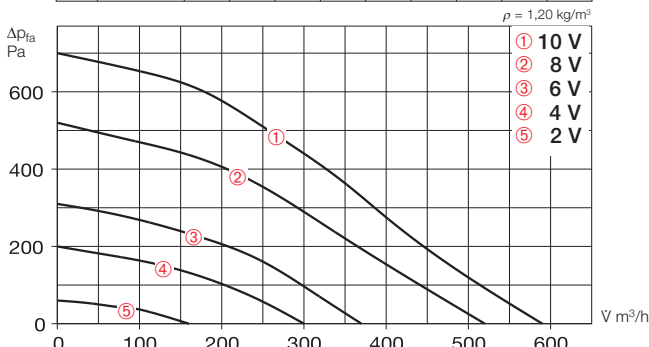

Free discharge						
Voltage V	n min ⁻¹	V̇ m³/h	P W	I A	Lp dB(A)	SFP kW/m²/s
10	3680	590	115	0,92	54	0,71
8	3250	520	80	0,61	51	0,55
6	2500	370	40	0,31	46	0,39
4	2000	300	22	0,19	41	0,25

Accessories

Flexible sleeve

Type FM 125 Ref. no. 1682

Supplied with two hose clips as standard; for installation between fan and duct system. Prevents sound and vibration transmission to ducting and corrects small site misalignments. For intake or extract two sleeves are needed for complete isolation.

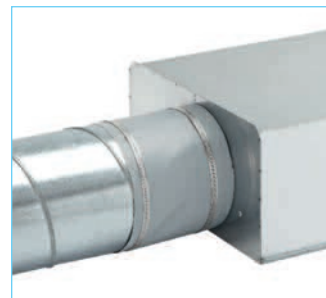

Gravity shutter

Type VK 125 Ref. no. 0857

Automatic made from polymer, white.



Fixed grille

Type G 160 Ref. no. 0893

Made from polymer, white.



Guard

Type SGR 125 Ref. no. 5064

For intake and extract installation. Made from powder-coated steel wire.



Backdraught shutter

Type RSKK 125 Ref. no. 5107

Automatic, made from polymer.



Flexible circular attenuator

Type FSD 125 Ref. no. 0677

Spigotted aluminium attenuator with 50 mm insulation. Length 1 m.



Air filter box

LFBR 125 G4 Ref. no. 8577

LFBR 125 F7 Ref. no. 8531

Air filter with large surface area, for installation in ducting.

Electric heater battery

EHR-R 0,8/125 0,8 kW No. 8709

EHR-R 1,2/125 1,2 kW No. 9433

- with integrated temp. control

EHR-R 0,8/125 TR 0,8 kW No. 5293

Room or duct sensor (TFK/TFR, accessories) required.



Temperature control system for electric heater battery EHR-R

Type EHS Ref. no. 5002



Warm water heater battery

Type WHR 125 Ref. no. 9480

Compact heat exchanger for in-line installation.

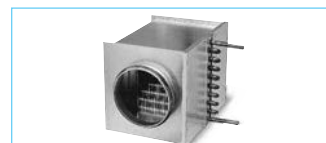

Temperature control system for warm water heater battery

Type WHST 300 T38 No. 8817



SilentBox® SB EC



Virtually noise-free with high air flow volumes against high resistances. Ideal for maintenance and cleaning.

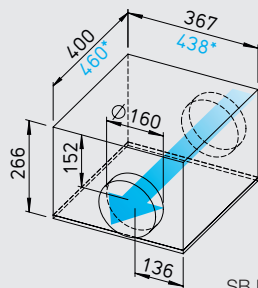

Dim. in mm

SB EC 160 A, *SB EC 160 B

SlimVent SVS EC



Ultra low profile. Ideal for applications with limited installation space. With sound-insulating mineral wool lining for particularly noise-free operation.

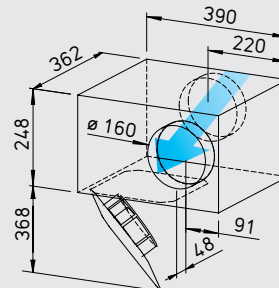

Dim. in mm

■ Similarities
SilentBox® SB EC and SlimVent SVS EC

□ Installation

Installation in any position without restriction – horizontally, vertically or pitched – suitable for intake or extract. Mounting bracket included in delivery.

□ Motor

Energy saving, speed controllable EC-external rotor motors with highest efficiency, protection to IP 44 (SB EC 160 A IP 54). With ball bearings, maintenance-free and interference-free. Dynamically balanced for low noise operation.

□ Speed control

Stepless speed control with potentiometer or stepless speed control with universal control system (see table). Duties at different speeds are exemplarily given in the performance curve.

□ Motor protection

Integrated electronic temperature monitoring for EC-motor and electronics.

□ Sound levels

See page 351.

■ Specification SilentBox® EC

□ Casing

Like an internal attenuator. Acoustically lined with abrasive resistant 50 mm thick mineral fibreboard. Four quick release clamps permit easy access to the impeller set. Motor-impeller unit can be pulled out, the pull-out range must be considered. Spigots on intake and exhaust fit twin-seal rubber gaskets fit standard ducts. All parts manufactured from galvanised sheet steel.

□ Impeller

With backward curved impeller. Inflow via inlet cone. SB EC 160 A forward curved

impeller in aerodynamically optimised volute casing, galvanised sheet steel.

□ Electrical connection

Terminal box (IP 54) mounted on running cable.

□ Protection class

With a connected pipe system IP 44 (SB EC 160 A IP 54).

■ Specification SlimVent SVS EC

□ Casing

Extremely flat casing in longer design with more than 50 mm thick sound-absorbing mineral wool lining and glass fibre surface. The acoustic box which is placed in front of the fan reduces the sound level for the intake significantly. The sound level of the case breakout is reduced to a smaller extent (see sound levels in the tables above the performance curves).

□ The swing out motor and impeller unit permits maintenance

and cleaning without disassembly of system components. The swing-out range of the motor-impeller unit must be considered.

□ Impeller

Energy-saving centrifugal impeller with backward curved blades from high quality polymer.

□ Electrical connection

Terminal box (IP 54) mounted on running cable.

□ Protection class

With a connected pipe system IP 44.

Type	Ref. no.	Connection Ø	Air flow volume (FID)	R.P.M.	Sound press. case breakout	Motor power	Current	Wiring diagram	max. air flow temperature	Weight net approx.	Universal control system		Speed-potentiometer flush		Speed-potentiometer surface	
											Type	Ref. no.	Type	Ref. no.	Type	Ref. no.
Type SilentBox® SB EC, 1 ph. motor, 230 V, 50/60 Hz, EC motor, IP 54 (A), IP 44 (B)																
SB EC 160 A	6136	160	540	2640	41	0.12	0.98	979	60	10.0	EUR EC ¹⁾²⁾	1347	PU 10 ¹⁾	1734	PA 10 ¹⁾	1735
SB EC 160 B	9625	160	670	3630	45	0.11	0.89	979	60	12.0	EUR EC ¹⁾²⁾	1347	PU 10 ¹⁾	1734	PA 10 ¹⁾	1735
Type SVS EC, 1 ph. motor, 230 V, 50/60 Hz, EC motor, IP 44																
SVS EC 160 A ³⁾	0017	160	620	3650	55	0.12	0.93	979	60	8.0	EUR EC ¹⁾²⁾	1347	PU 10 ¹⁾	1734	PA 10 ¹⁾	1735
SVS EC 160 B	0018	160	800	3100	55	0.13	1.04	979	60	7.6	EUR EC ¹⁾²⁾	1347	PU 10 ¹⁾	1734	PA 10 ¹⁾	1735

1) Several EC fans can normally be connected. 2) alternative electronic differential pressure/temp. controller (EDR/ETR, No. 1437/1438) or three step speed controller (SU/SA, No. 4266/4267), see accessories.

3) Characteristic curve on www.HeliosSelect.de

SB EC 160 A

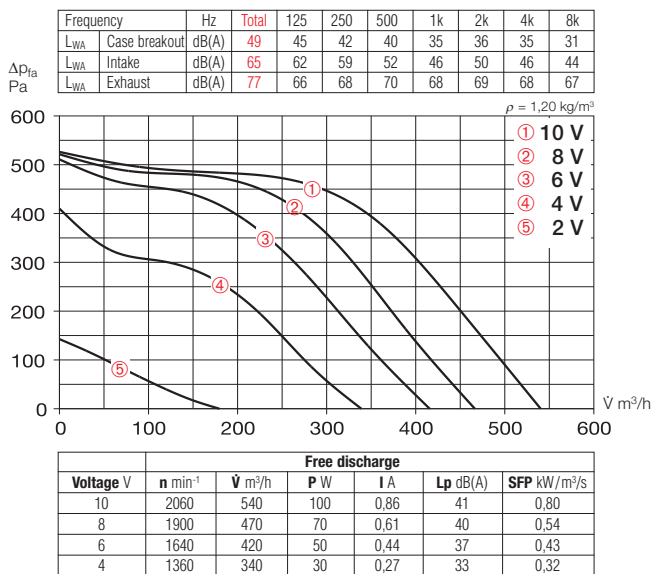

SB EC 160 B

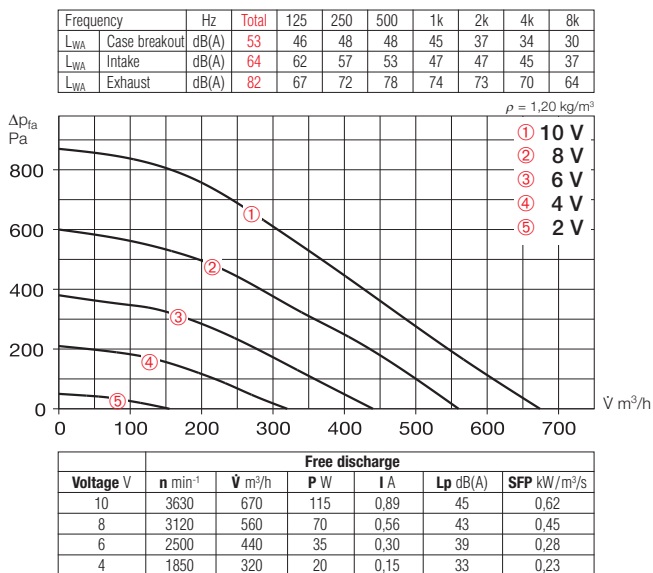

SVS EC 160 B

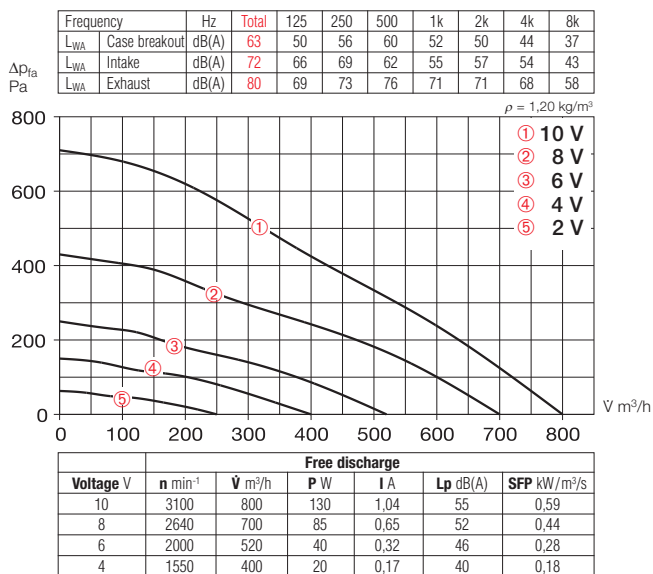

Accessories

Flexible sleeve

Type FM 160 Ref. no. 1684

Supplied with two hose clips as standard; for installation between fan and duct system. Prevents sound and vibration transmission to ducting and corrects small site misalignments. For intake or extract two sleeves are needed for complete isolation.

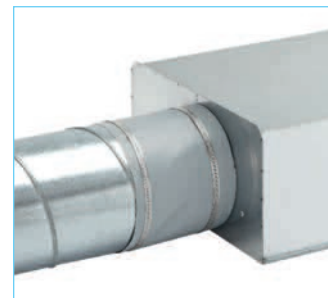

Gravity shutter

Type VK 160 Ref. no. 0892

Automatic made from polymer, white.



Fixed grille

Type G 160 Ref. no. 0893

Made from polymer, white.



Guard

Type SGR 160 Ref. no. 5069

For intake and extract installation. Made from galvanised steel.



Backdraught shutter

Type RSK 160 Ref. no. 5669

Automatic, made from metal.

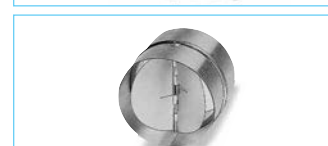

Flexible circular attenuator

Type FSD 160 Ref. no. 0678

Spigotted aluminium attenuator with 50 mm insulation. Length 1 m.



Air filter box

LFBR 160 G4 Ref. no. 8578

LFBR 160 F7 Ref. no. 8532

Air filter with large surface area, for installation in ducting.



Electric heater battery

EHR-R 1,2/160 1,2 kW No. 9434

EHR-R 2,4/160 2,4 kW No. 9435

EHR-R 5/160 5,0 kW No. 8710

– with integrated temp. control

EHR-R 2,4/160 TR 2,4 kW No. 5294

Room or duct sensor (TFK/TFR, accessories) required.



Temperature control system for electric heater battery EHR-R

Type EHS Ref. no. 5002



Warm water heater battery

Type WHR 160 Ref. no. 9481

Compact heat exchanger for in-line installation.

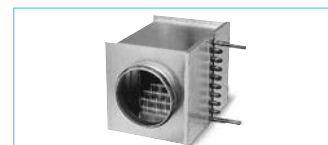

Temperature control system for warm water heater battery

Type WHST 300 T38 No. 8817



SilentBox® SB EC



acousticline

Virtually noise-free with high air flow volumes against high resistances. Ideal for maintenance and cleaning.

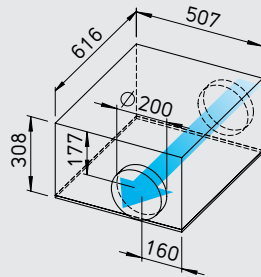

Dim. in mm

SlimVent SVS EC



acousticline

Ultra low profile. Ideal for applications with limited installation space. With sound-insulating mineral wool lining for particularly noise-free operation.

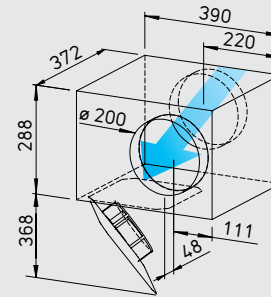

Dim. in mm

■ **Similarities**
SilentBox® SB EC
and SlimVent SVS EC

□ **Installation**

Installation in any position without restriction – horizontally, vertically or pitched – suitable for intake or extract. Mounting bracket included in delivery.

□ **Motor**

Energy saving, speed controllable EC-external rotor motors with highest efficiency, protection to IP 44 (SB EC 200 A IP 54). With ball bearings, maintenance-free and interference-free. Dynamically balanced for low noise operation.

□ **Speed control**

Stepless speed control with potentiometer or stepless speed control with universal control system (see table). Duties at different speeds are exemplarily given in the performance curve.

□ **Motor protection**

Integrated electronic temperature monitoring for EC-motor and electronics.

□ **Sound levels**

See page 351.

■ **Specification SilentBox® EC**

□ **Casing**

Like an internal attenuator. Acoustically lined with abrasive resistant 50 mm thick mineral fibreboard. Four quick release clamps permit easy access to the impeller set. Motor-impeller unit can swing-out, the swing-out range of the motor-impeller unit must be considered. Spigots on intake and exhaust twin-seal rubber gaskets fit standard ducts. All parts manufactured from galvanised sheet steel.

□ **Impeller**

With backward curved impeller. Inflow via inlet cone.

□ **Electrical connection**

Terminal box (IP 54) mounted on running cable.

□ **Protection class**

With a connected pipe system IP 44 (SB EC 200 A IP 54).

■ **Specification SlimVent SVS EC**

□ **Casing**

Extremely flat casing in longer design with more than 50 mm thick sound-absorbing mineral wool lining and glass fibre surface. The acoustic box which is placed in front of the fan reduces the sound level for the intake significantly. The sound level of the case breakout is reduced to a smaller extent (see sound levels in the tables above the performance curves).

□ The swing out motor and impeller unit permits maintenance and cleaning without disassembly of system components. The swing-out range of the

motor-impeller unit must be considered.

□ **Impeller**

Energy-saving centrifugal impeller with backward curved blades from high quality polymer.

□ **Electrical connection**

Terminal box (IP 54) mounted on running cable.

□ **Protection class**

With a connected pipe system IP 44.

65% Saving*
* with speed control

Type	Ref. no.	Connection Ø	Air flow volume (FID)	R.P.M.	Sound press. case breakout	Motor power	Current	Wiring diagram	max. air flow temperature	Weight net approx.	Universal control system		Speed-potentiometer flush		Speed-potentiometer surface	
											Type	Ref. no.	Type	Ref. no.	Type	Ref. no.
Type SilentBox® SB EC, 1 ph. motor, 230 V, 50/60 Hz, EC motor, IP 54 (A), IP 44 (B)																
SB EC 200 A	6138	200	910	2900	45	0.12	0.99	979	60	19.0	EUR EC ¹⁾²⁾	1347	PU 10 ¹⁾	1734	PA 10 ¹⁾	1735
SB EC 200 B	9626	200	1160	2890	50	0.16	1.24	979	60	19.0	EUR EC ¹⁾²⁾	1347	PU 10 ¹⁾	1734	PA 10 ¹⁾	1735
Type SVS EC, 1 ph. motor, 230 V, 50/60 Hz, EC motor, IP 44																
SVS EC 200	0019	200	1030	2820	55	0.16	1.25	979	60	8.3	EUR EC ¹⁾²⁾	1347	PU 10 ¹⁾	1734	PA 10 ¹⁾	1735

1) Several EC fans can normally be connected. 2) alternative electronic differential pressure/temp. controller (EDR/ETR, No. 1437/1438) or three step speed controller (SU/SA, No. 4266/4267), see accessories.

SB EC 200 A

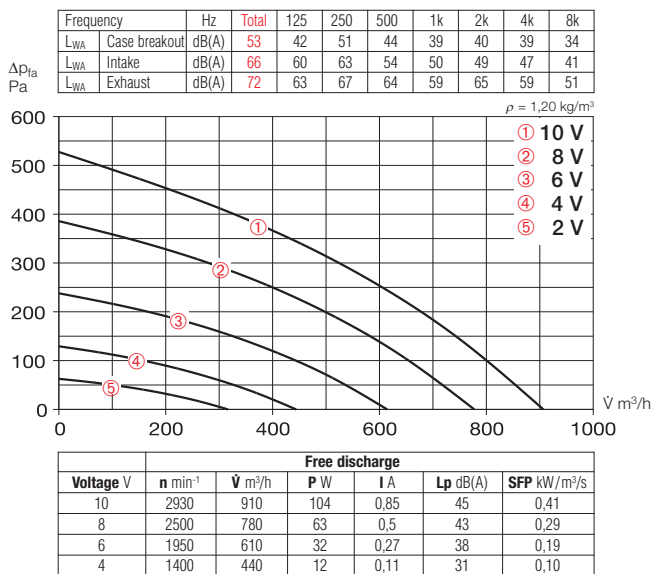

SB EC 200 B

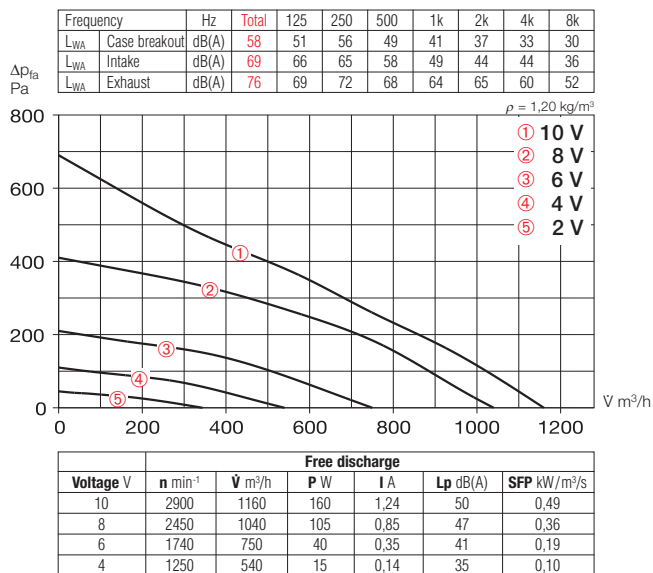

SVS EC 200

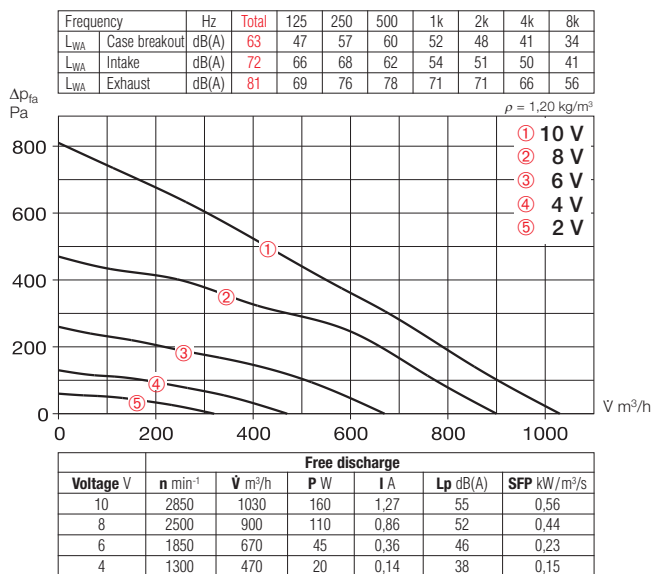

Accessories

Flexible sleeve

Type FM 200 Ref. no. 1670
Supplied with two hose clips as standard; for installation between fan and duct system. Prevents sound and vibration transmission to ducting and corrects small site misalignments. For intake or extract two sleeves are needed for complete isolation.

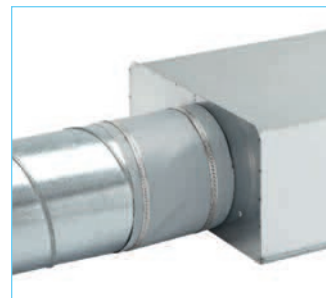

Gravity shutter

Type VK 200 Ref. no. 0758
Made from polymer, light grey.



Fixed grille

Type RAG 200 Ref. no. 0750
For covering air inlets and outlets on facades. Made from polymer, light grey.



Guard

Type SGR 200 Ref. no. 5066
For intake and extract installation. Made from galvanised steel.



Backdraught shutter

Type RSK 200 Ref. no. 5074
Automatic, made from metal.



Flexible circular attenuator

Type FSD 200 Ref. no. 0679
Spigotted aluminium attenuator with 50 mm insulation. Length 1 m.



Air filter box

LFBR 200 G4 Ref. no. 8579
LFBR 200 F7 Ref. no. 8533
Air filter with large surface area, for installation in ducting.



Electric heater battery

EHR-R 1,2/200 1,2 kW No. 9436
EHR-R 2/200 2,0 kW No. 9437
EHR-R 5/200 5,0 kW No. 8711
- with integrated temp. control
EHR-R 5/200 TR 5,0 kW No. 5295
Room or duct sensor (TFK/TFR, accessories) required.



Temperature control system for electric heater battery EHR-R
Type EHS Ref. no. 5002



Warm water heater battery

Type WHR 200 Ref. no. 9482
Compact heat exchanger for in-line installation.

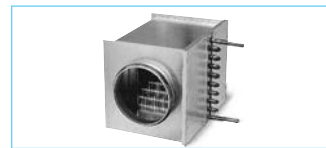

Temperature control system for warm water heater battery
Type WHST 300 T38 No. 8817



SilentBox® SB EC



Virtually noise-free with high air flow volumes against high resistances. Ideal for maintenance and cleaning.

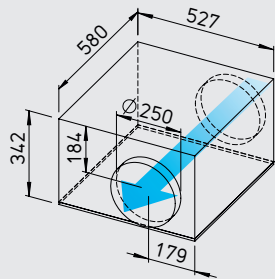

Dim. in mm

SlimVent SVS EC



Ultra low profile. Ideal for applications with limited installation space. With sound-insulating mineral wool lining for particularly noise-free operation.

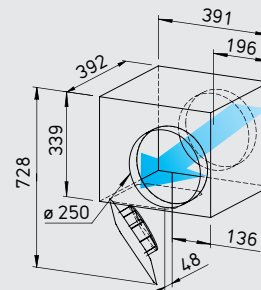

Dim. in mm

■ **Similarities SilentBox® SB EC and SlimVent SVS EC**

□ **Installation**

Installation in any position without restriction – horizontally, vertically or pitched – suitable for intake or extract. Mounting bracket included in delivery.

□ **Motor**

Energy saving, speed controllable EC-external rotor motors with highest efficiency, protection to IP 44. With ball bearings, maintenance-free and interference-free. Dynamically balanced for low noise operation.

□ **Speed control**

Stepless speed control with potentiometer or stepless speed control with universal control system (see table). Duties at different speeds are exemplarily given in the performance curve.

□ **Motor protection**

Integrated electronic temperature monitoring for EC-motor and electronics.

■ **Specification SilentBox® EC**

□ **Casing**

Like an internal attenuator. Acoustically lined with abrasive resistant 50 mm thick mineral fibreboard. Four quick release clamps permit easy access to the impeller set. Motor-impeller unit can swing-out, the swing-out range of the motor-impeller unit must be considered. Spigots on intake and exhaust twin-seal rubber gaskets fit standard ducts. All parts manufactured from galvanised sheet steel.

□ **Impeller**

With backward curved impeller. Inflow via inlet cone.

□ **Electrical connection**

Terminal box (IP 54) mounted on running cable.

□ **Protection class**

With a connected pipe system IP 44.

■ **Specification SlimVent SVS EC**

□ **Casing**

Extremely flat casing in longer design with more than 50 mm thick sound-absorbing mineral wool lining and glass fibre surface. The acoustic box which is placed in front of the fan reduces the sound level for the intake significantly. The sound level of the case breakout is reduced to a smaller extent (see sound levels in the tables above the performance curves).

□ The swing out motor and impeller unit permits maintenance and cleaning without disassembly of system components. The swing-out range of the

motor-impeller unit must be considered.

□ **Impeller**

Energy-saving centrifugal impeller with backward curved blades from high quality polymer.

□ **Electrical connection**

Terminal box (IP 54) mounted on running cable.

□ **Protection class**

With a connected pipe system IP 44.

Type	Ref. no.	Connection Ø	Air flow volume (FID)	R.P.M.	Sound press. case breakout	Motor power	Current	Wiring diagram	max. air flow temperature	Weight net approx.	Universal control system		Speed-potentiometer flush		Speed-potentiometer surface	
											Type	Ref. no.	Type	Ref. no.	Type	Ref. no.
Type SilentBox® SB EC, 1 ph. motor, 230 V, 50/60 Hz, EC motor, IP 44																
SB EC 250	9627	250	1250	2760	50	0.16	1.27	979	60	17.5	EUR EC ¹⁾²⁾	1347	PU 10 ¹⁾	1734	PA 10 ¹⁾	1735
Type SVS EC, 1 ph. motor, 230 V, 50/60 Hz, EC motor, IP 44																
SVS EC 250	6125	250	1250	2700	51	0.15	1.27	979	50	9.1	EUR EC ¹⁾²⁾	1347	PU 10 ¹⁾	1734	PA 10 ¹⁾	1735

1) Several EC fans can normally be connected. 2) alternative electronic differential pressure/temp. controller (EDR/ETR, No. 1437/1438) or three step speed controller (SU/SA, No. 4266/4267), see accessories.

SB EC 250

Frequency	Hz	Total	125	250	500	1k	2k	4k	8k
L _{WA} Case breakout	dB(A)	58	49	57	48	41	37	33	30
L _{WA} Intake	dB(A)	69	63	66	55	50	50	47	38
L _{WA} Exhaust	dB(A)	77	67	72	67	67	69	63	52

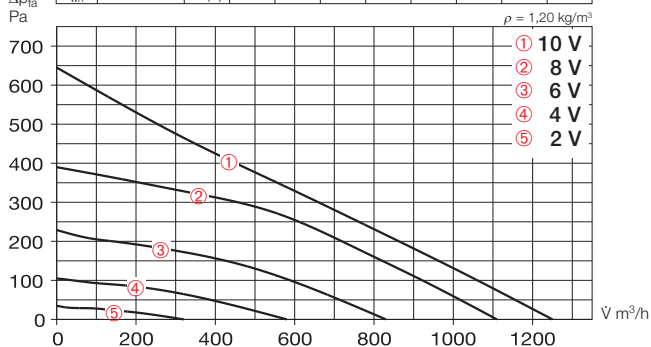

Free discharge						
Voltage V	n min ⁻¹	V̇ m³/h	P W	I A	Lp dB(A)	SFP kW/m²/s
10	2760	1250	163	1.27	50	0.47
8	2480	1110	110	0.90	49	0.36
6	1850	830	50	0.42	44	0.22
4	1250	580	15	0.14	37	0.09

SVS EC 250

Frequency	Hz	Total	125	250	500	1k	2k	4k	8k
L _{WA} Case breakout	dB(A)	59	47	56	56	48	44	37	32
L _{WA} Intake	dB(A)	72	65	70	57	55	56	54	45
L _{WA} Exhaust	dB(A)	82	68	78	77	72	73	69	61

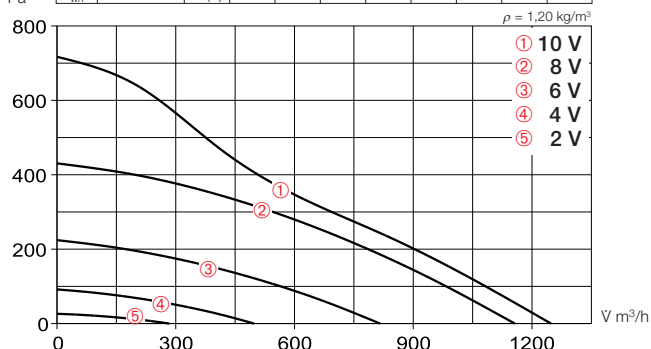

Free discharge						
Voltage V	n min ⁻¹	V̇ m³/h	P W	I A	Lp dB(A)	SFP kW/m²/s
10	2700	1250	150	1.2	51	0.43
8	2450	1160	120	0.98	49	0.37
6	1720	820	45	0.35	42	0.20
4	1050	500	12	0.10	32	0.09

Sound levels

Total sound power levels and the spectrum figures in dB(A) are given for:

- Sound level case breakout
- Sound level intake
- Sound level exhaust

In the table below as well as underneath the performance curve you can find additionally the sound pressure level at 1 m (free field conditions).

Accessory details Page

Filters, heater batteries and attenuators	421 on
Temperature control systems for heater batteries	427, 431 on
Flexible ventilation ducting, Grilles, adaptors, roof terminations	487 on
Valves	508 on
Universal control system, electronic controller, speed-potentiometer	539 on

Accessories

Flexible sleeve

Type FM 250 Ref. no. 1672

Supplied with two hose clips as standard; for installation between fan and duct system. Prevents sound and vibration transmission to ducting and corrects small site misalignments. For intake or extract two sleeves are needed for complete isolation.

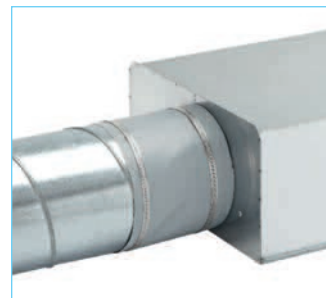

Gravity shutter

Type VK 250 Ref. no. 0759

Automatic made from polymer, light grey.



Fixed grille

Type RAG 250 Ref. no. 0751

For covering air inlets and outlets on facades. Made from polymer, light grey.



Guard

Type SGR 250 Ref. no. 5067

For intake and extract installation. Made from galvanised steel.



Backdraught shutter

Type RSK 250 Ref. no. 5673

Automatic, made from metal.



Flexible circular attenuator

Type FSD 250 Ref. no. 0680

Spigotted aluminium attenuator with 50 mm insulation. Length 1 m.



Air filter box

LFBR 250 G4 Ref. no. 8580

LFBR 250 F7 Ref. no. 8534

Air filter with large surface area, for installation in ducting.



Electric heater battery

EHR-R 6/250 6,0 kW No. 8712

– with integrated temp. control

EHR-R 6/250 TR 6,0 kW No. 5296

Room or duct sensor (TFK/TFR, accessories) required.



Temperature control system for electric heater battery EHR-R

Type EHS Ref. no. 5002



Warm water heater battery

Type WHR 250 Ref. no. 9483

Compact heat exchanger for in-line installation.

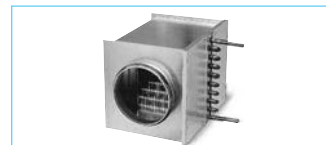

Temperature control system for warm water heater battery

Type WHS HE Ref. no. 8319



SilentBox® SB EC



Virtually noise-free with high air flow volumes against high resistances. Ideal for maintenance and cleaning.

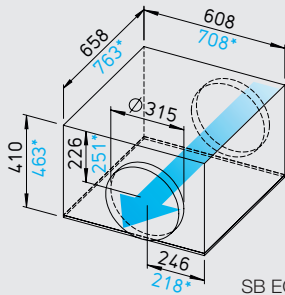

Dim. in mm

SB EC 315 A, *SB EC 315 B

SlimVent SVS EC



Ultra low profile. Ideal for applications with limited installation space. With sound-insulating mineral wool lining for particularly noise-free operation.

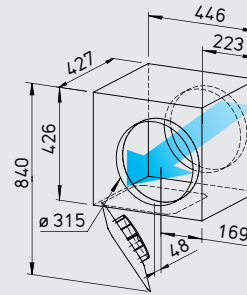

Dim. in mm

■ **Similarities SilentBox® SB EC and SlimVent SVS EC**

□ **Installation**

Installation in any position without restriction – horizontally, vertically or pitched – suitable for intake or extract. Mounting bracket included in delivery.

□ **Motor**

Energy saving, speed controllable EC-external rotor motors with highest efficiency, protection to IP 54 (SB EC) or IP 44 (SVS EC). With ball bearings, maintenance-free and interference-free. Dynamically balanced for low noise operation.

□ **Speed control**

Stepless speed control with potentiometer or stepless speed control with universal control system (see table). Duties at different speeds are exemplarily given in the performance curve.

□ **Motor protection**

Integrated electronic temperature monitoring for EC-motor and electronics.

□ **Sound levels**

See page 351.

■ **Specification SilentBox® EC**

□ **Casing**

Like an internal attenuator. Acoustically lined with abrasive resistant 50 mm thick mineral fibreboard. Four quick release clamps permit easy access to the impeller set. Motor-impeller unit can swing-out, the swing-out range of the motor-impeller unit must be considered. Spigots on intake and exhaust twin-seal rubber gaskets fit standard ducts. All parts manufactured from galvanised sheet steel.

□ **Impeller**

With backward curved impeller. Inflow via inlet cone.

□ **Electrical connection**

Terminal box (IP 54) mounted on running cable (approx. 60 cm long).

□ **Protection class**

With a connected pipe system IP 54.

■ **Specification SlimVent SVS EC**

□ **Casing**

Extremely flat casing in longer design with more than 50 mm thick sound-absorbing mineral wool lining and glass fibre surface. The acoustic box which is placed in front of the fan reduces the sound level for the intake significantly. The sound level of the case breakout is reduced to a smaller extent (see sound levels in the tables above the performance curves).

□ The swing out motor and impeller unit permits maintenance and cleaning without disassembly of system components.

The swing-out range of the motor-impeller unit must be considered.

□ **Impeller**

Energy-saving centrifugal impeller with backward curved blades from high quality polymer.

□ **Electrical connection**

Terminal box (IP 54) mounted on running cable.

□ **Protection class**

With a connected pipe system IP 44.

Type	Ref. no.	Connection Ø	Air flow volume (FID)	R.P.M.	Sound press. case breakout	Motor power	Current	Wiring diagram	max. air flow temperature	Weight net approx.	Universal control system		Speed-potentiometer flush		Speed-potentiometer surface	
											Type	Ref. no.	Type	Ref. no.	Type	Ref. no.
Type SilentBox® SB EC, 1 ph. motor, 230 V, 50/60 Hz, EC motor, IP 54																
SB EC 315 A	6157	315	2160	2020	55	0.33	1.50	1066	60	34.0	EUR EC ¹⁾²⁾	1347	PU 10 ¹⁾	1734	PA 10 ¹⁾	1735
SB EC 315 B	9628	315	2640	1650	51	0.31	1,36	1066	60	49.0	EUR EC ¹⁾²⁾	1347	PU 10 ¹⁾	1734	PA 10 ¹⁾	1735
Type SVS EC, 1 ph. motor, 230 V, 50/60 Hz, EC motor, IP 44																
SVS EC 315	6126	315	1630	2400	51	0.23	0.99	979	45	14.5	EUR EC ¹⁾²⁾	1347	PU 10 ¹⁾	1734	PA 10 ¹⁾	1735

1) Several EC fans can normally be connected. 2) alternative electronic differential pressure/temp. controller (EDR/ETR, No. 1437/1438) or three step speed controller (SU/SA, No. 4266/4267), see accessories.

SB EC 315 A

Frequency	Hz	Total	125	250	500	1k	2k	4k	8k
L _{WA} Case breakout	dB(A)	63	52	62	51	41	39	39	35
L _{WA} Intake	dB(A)	73	68	70	54	48	50	46	44
L _{WA} Exhaust	dB(A)	79	70	78	67	65	61	57	55

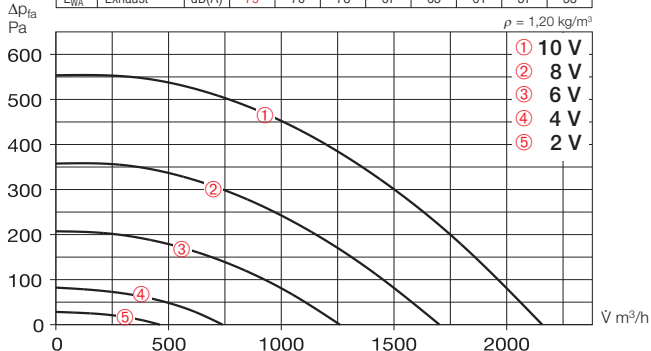

Free discharge						
Voltage V	n min ⁻¹	V̇ m³/h	P W	I A	Lp dB(A)	SFP kW/m²/s
10	2020	2160	330	1,44	55	0,55
8	1620	1700	170	0,76	51	0,36
6	1210	1260	75	0,34	45	0,21
4	770	740	25	0,15	36	0,12

SB EC 315 B

Frequency	Hz	Total	125	250	500	1k	2k	4k	8k
L _{WA} Case breakout	dB(A)	59	56	57	43	34	30	27	27
L _{WA} Intake	dB(A)	69	67	64	50	41	40	39	37
L _{WA} Exhaust	dB(A)	77	75	72	62	61	57	55	53

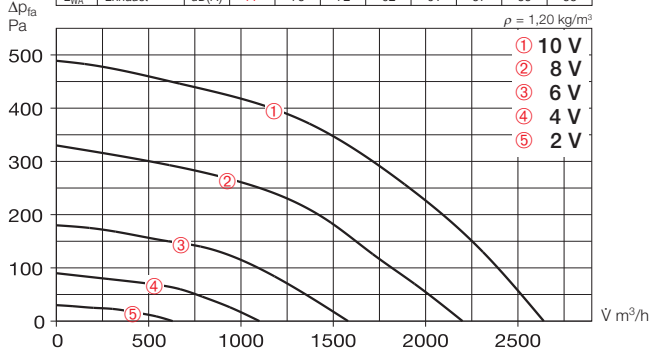

Free discharge						
Voltage V	n min ⁻¹	V̇ m³/h	P W	I A	Lp dB(A)	SFP kW/m²/s
10	1650	2640	280	1,23	51	0,38
8	1350	2200	155	0,68	47	0,25
6	1000	1580	70	0,31	42	0,16
4	700	1100	26	0,13	37	0,09

SVS EC 315

Frequency	Hz	Total	125	250	500	1k	2k	4k	8k
L _{WA} Case breakout	dB(A)	59	45	53	56	49	47	42	38
L _{WA} Intake	dB(A)	73	67	66	57	60	64	60	56
L _{WA} Exhaust	dB(A)	82	67	70	79	72	76	71	67

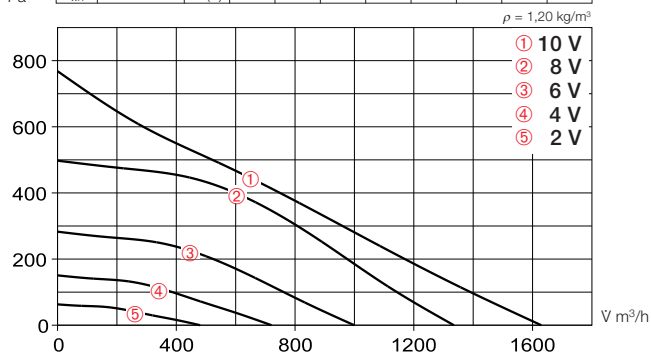

Free discharge						
Voltage V	n min ⁻¹	V̇ m³/h	P W	I A	Lp dB(A)	SFP kW/m²/s
10	2700	1630	220	0,96	51	0,49
8	2240	1330	130	0,57	47	0,35
6	1680	1000	60	0,25	41	0,22
4	1200	720	25	0,13	34	0,13

Accessories

Flexible sleeve

Type FM 315 Ref. no. 1674

Supplied with two hose clips as standard; for installation between fan and duct system. Prevents sound and vibration transmission to ducting and corrects small site misalignments. For intake or extract two sleeves are needed for complete isolation.

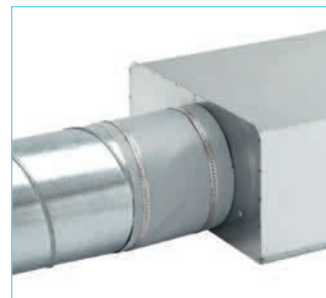

Gravity shutter

Type VK 315 Ref. no. 0760

Automatic made from polymer, light grey.



Fixed grille

Type RAG 315 Ref. no. 0752

For covering air inlets and outlets on facades. Made from polymer, light grey.



Guard

Type SGR 315 Ref. no. 5068

For intake and extract installation. Made from galvanised steel.



Backdraught shutter

Type RSK 315 Ref. no. 5674

Automatic, made from metal.



Flexible circular attenuator

Type FSD 315 Ref. no. 0681

Spigotted aluminium attenuator with 50 mm insulation. Length 1 m.



Air filter box

LFBR 315 G4 Ref. no. 8581

LFBR 315 F7 Ref. no. 8535

Air filter with large surface area, for installation in ducting.



Electric heater battery

EHR-R 6/315 6,0 kW No. 8713

– with integrated temp. control

EHR-R 6/315 TR 6,0 kW No. 5301

Room or duct sensor (TFK/TFR, accessories) required.



Temperature control system for electric heater battery EHR-R

Type EHS Ref. no. 5002



Warm water heater battery

Type WHR 315 Ref. no. 9484

Compact heat exchanger for in-line installation.

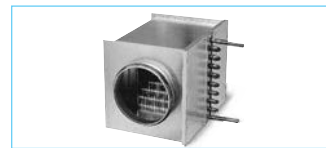

Temperature control system for warm water heater battery

Type WHS HE Ref. no. 8319



SilentBox® SB EC



Virtually noise-free with high air flow volumes against high resistances. Ideal for maintenance and cleaning.

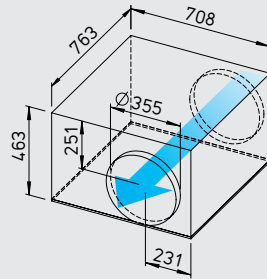

Dim. in mm

■ Specification

□ Casing

Like an internal attenuator. Acoustically lined with abrasive resistant 50 mm thick mineral fibreboard. Four quick release clamps permit easy access to the impeller set. Motor-impeller unit can swing-out, the swing-out range of the motor-impeller unit must be considered. Spigots on intake and exhaust twin-seal rubber gaskets fit standard ducts. All parts manufactured from galvanised sheet steel.

□ Impeller

With backward curved impeller. Inflow via inlet cone.

□ Motor

Energy saving, speed controllable EC-external rotor motors with highest efficiency, protection to IP 54. With ball bearings, maintenance-free and interference-free. Dynamically balanced for low noise operation.

□ Motor protection

Integrated electronic temperature monitoring for EC-motor and electronics.

□ Speed control

Stepless speed control with potentiometer or stepless speed control with universal control system (see table). Duties at different speeds are exemplarily given in the performance curve.

□ Electrical connection

Terminal box (IP 54) mounted on running cable (approx. 60 cm long).

□ Protection class

With a connected pipe system IP 54.

□ Installation

Installation in any position without restriction – horizontally, vertically or pitched – suitable for intake or extract. Mounting bracket included in delivery.

■ Sound levels

Total sound power levels and the spectrum figures in dB(A) are given for:

- Sound level case breakout
 - Sound level intake
 - Sound level exhaust
- In the table below as well as underneath the performance curve you can find additionally the sound pressure level at 1 m (free field conditions).

Type	Ref. no.	Connection Ø	Air flow volume (FID)	R.P.M.	Sound press. case breakout	Motor power	Current	Wiring diagram	max. air flow temperature	Weight net approx.	Universal control system		Speed-potentiometer flush		Speed-potentiometer surface	
											Type	Ref. no.	Type	Ref. no.	Type	Ref. no.
Type SilentBox® SB EC, 1 ph. motor 230 V, 50/60 Hz, EC motor, IP 54																
SB EC 355	6139	355	2670	1650	51	0.32	1.40	1066	60	37.0	EUR EC¹⁾²⁾	1347	PU 10¹⁾	1734	PA 10¹⁾	1735

1) Several EC fans can normally be connected. 2) alternative electronic differential pressure/temp. controller (EDR/ETR, No. 1437/1438) or three step speed controller (SU/SA, No. 4266/4267), see accessories.

SB EC 355

Frequency	Hz	Total	125	250	500	1k	2k	4k	8k
L _{WA} Case breakout	dB(A)	59	52	58	44	38	37	36	32
L _{WA} Intake	dB(A)	70	68	63	49	44	46	41	41
L _{WA} Exhaust	dB(A)	74	71	70	61	59	57	53	50

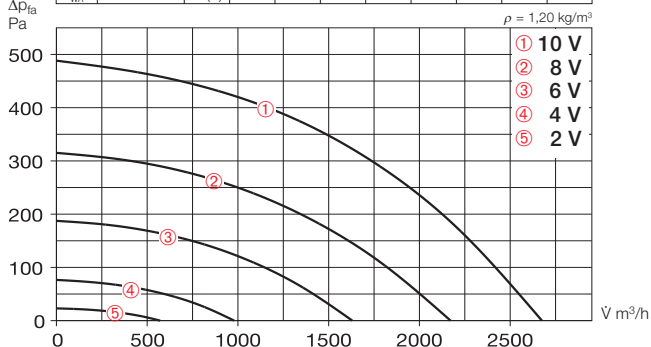

Free discharge						
Voltage V	n min ⁻¹	Ṡ m³/h	P W	I A	Lp dB(A)	SFP kW/m²/s
10	1650	2670	280	1,26	51	0,38
8	1320	2170	150	0,66	47	0,25
6	1000	1630	70	0,31	41	0,15
4	600	980	20	0,12	30	0,07

Accessory details Page

Filters, heater batteries and attenuators	421 on
Temperature control systems for heater batteries	427, 431 on
Flexible ventilation ducting, Grilles, adaptors, roof terminations	487 on
Valves	508 on
Universal control system, electronic controller, speed-potentiometer	539 on

Accessories

Flexible sleeve

Type FM 355 Ref. no. 1675

Supplied with two hose clips as standard; for installation between fan and duct system. Prevents sound and vibration transmission to ducting and corrects small site misalignments. For intake or extract two sleeves are needed for complete isolation.

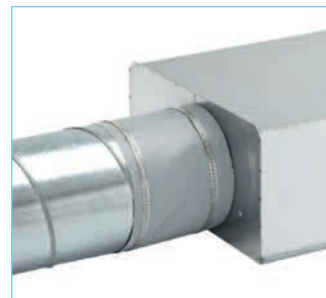

Gravity shutter

Type VK 355 Ref. no. 0761

Automatic made from polymer, light grey.



Fixed grille

Type RAG 355 Ref. no. 0753

For covering air inlets and outlets on facades. Made from polymer, light grey.



Backdraught shutter

Type RSK 355 Ref. no. 5650

Automatic, made from metal.



Flexible circular attenuator

Type FSD 355 Ref. no. 0682

Spigotted aluminium attenuator with 50 mm insulation. Length 1 m.



Air filter box

LFBR 355 G4 Ref. no. 8583

LFBR 355 F7 Ref. no. 8536

Air filter with large surface area and capacity for installation in ducting. Connections with double lip seals, adapted to standard Ø.



Electric heater battery

EHR-R 355 9,0 kW No. 8656

– with integrated temp. control

EHR-R 9/355 TR 9,0 kW No. 5297

Room or duct sensor (TFK/TFR, accessories) required.



Temperature control system for electric heater battery EHR-R

Type EHSD 16 Ref. no. 5003



Warm water heater battery

Type WHR 355 Ref. no. 8790

Compact heat exchanger for in-line installation.

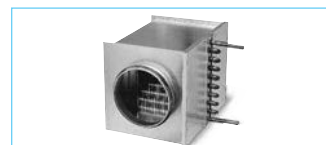

Temperature control system for warm water heater battery

Type WHS HE Ref. no. 8319



SilentBox® SB EC



Virtually noise-free with high air flow volumes against high resistances. Ideal for maintenance and cleaning.

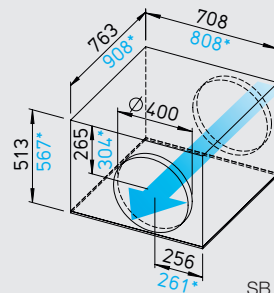

Dim. in mm

SB EC 400 A, *SB EC 400 B

■ Specification

□ Casing

Like an internal attenuator. Acoustically lined with abrasive resistant 50 mm thick mineral fibreboard. Four quick release clamps permit easy access to the impeller set. Motor-impeller unit can swing-out, the swing-out range of the motor-impeller unit must be considered. Spigots on intake and exhaust twin-seal rubber gaskets fit standard ducts. All parts manufactured from galvanised sheet steel.

□ Impeller

With backward curved impeller. Inflow via inlet cone.

□ Motor

Energy saving, speed controllable EC-external rotor motors with highest efficiency, protection to IP 54. With ball bearings, maintenance-free and interference-free. Dynamically balanced for low noise operation.

□ Motor protection

Integrated electronic temperature monitoring for EC-motor and electronics.

□ Speed control

Stepless speed control with potentiometer or stepless speed control with universal control system (see table). Duties at different speeds are exemplarily given in the performance curve.

□ Electrical connection

Terminal box (IP 54) mounted on running cable (approx. 60 cm long).

□ Protection class

With a connected pipe system IP 54.

□ Installation

Installation in any position without restriction – horizontally, vertically or pitched – suitable for intake or extract. Mounting bracket included in delivery.

■ Sound levels

Total sound power levels and the spectrum figures in dB(A) are given for:

- Sound level case breakout
 - Sound level intake
 - Sound level exhaust
- In the table below as well as underneath the performance curve you can find additionally the sound pressure level at 1 m (free field conditions).

Type	Ref. no.	Connection Ø	Air flow volume (FID)	R.P.M.	Sound press. case breakout	Motor power	Current	Wiring diagram	max. air flow temperature	Weight net approx.	Universal control system		Speed-potentiometer flush		Speed-potentiometer surface	
											Type	Ref. no.	Type	Ref. no.	Type	Ref. no.
Type SilentBox® SB EC, 1 ph. motor, 230 V, 50/60 Hz, EC motor, IP 54																
SB EC 400 A	6140	400	3000	1650	53	0.34	1.50	1066	60	45.0	EUR EC ¹⁾²⁾	1347	PU 10 ¹⁾	1734	PA 10 ¹⁾	1735
SB EC 400 B	9629	400	4760	1420	56	0.65	2.98	982	60	60.8	EUR EC ¹⁾²⁾	1347	PU 10 ¹⁾	1734	PA 10 ¹⁾	1735

1) Several EC fans can normally be connected. 2) alternative electronic differential pressure/temp. controller (EDR/ETR, No. 1437/1438) or three step speed controller (SU/SA, No. 4266/4267), see accessories.

SB EC 400 A

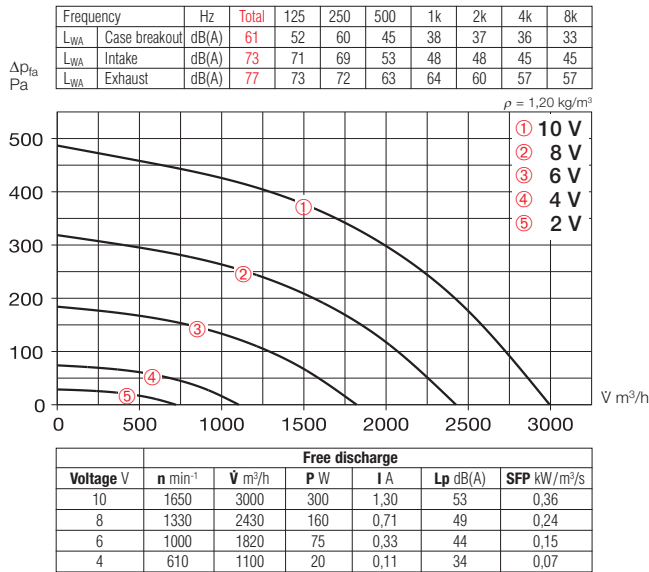

SB EC 400 B

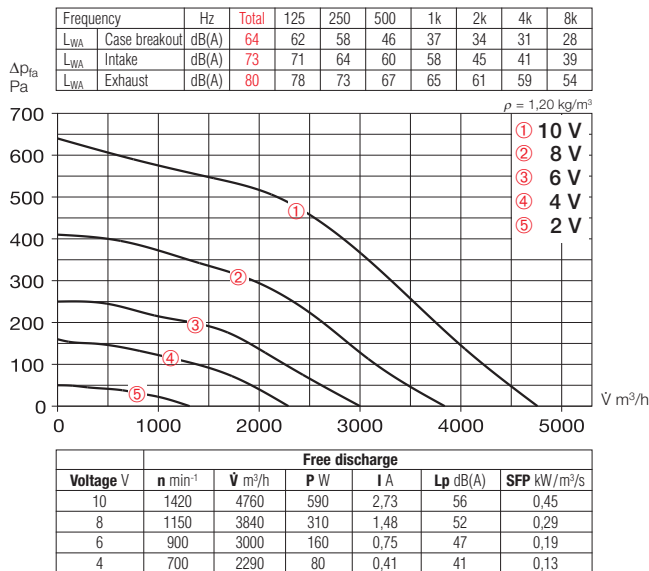

Accessory details	Page
Filters, heater batteries and attenuators	421 on
Temperature control systems for heater batteries	427, 431 on
Flexible ventilation ducting, Grilles, adaptors, roof terminations	487 on
Valves	508 on
Universal control system, electronic controller, speed-potentiometer	539 on

Accessories

Flexible sleeve

Type FM 400 Ref. no. 1676
Supplied with two hose clips as standard; for installation between fan and duct system. Prevents sound and vibration transmission to ducting and corrects small site misalignments. For intake or extract two sleeves are needed for complete isolation.

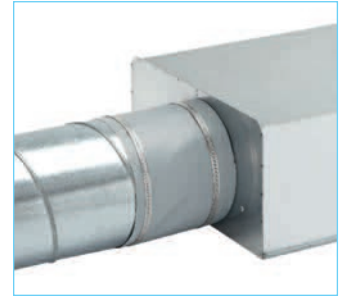

Gravity shutter

Type VK 400 Ref. no. 0762
Automatic made from polymer, light grey.



Fixed grille

Type RAG 400 Ref. no. 0754
For covering air inlets and outlets on facades. Made from polymer, light grey.



Backdraught shutter

Type RSK 400 Ref. no. 5651
Automatic, made from metal.



Flexible circular attenuator

Type FSD 400 Ref. no. 0683
Spigotted aluminium attenuator with 50 mm insulation. Length 1 m.



Air filter box

LFBR 400 G4 Ref. no. 8582
LFBR 400 F7 Ref. no. 8537
Air filter with large surface area and capacity for installation in ducting. Connections with double lip seals, adapted to standard Ø.



Electric heater battery

EHR-R 9/400 9,0 kW No. 8657
– with integrated temp. control
EHR-R 9/400 TR 9,0 kW No. 5299
Room or duct sensor (TFK/TFR, accessories) required.



Temperature control system for electric heater battery EHR-R
Type EHSD 16 Ref. no. 5003



Warm water heater battery

Type WHR 400 Ref. no. 9524
Compact heat exchanger for in-line installation.

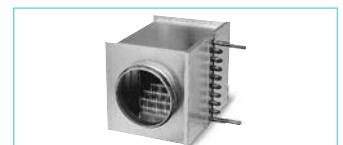

Temperature control system for warm water heater battery
Type WHS HE Ref. no. 8319



SilentBox® SB



Virtually noise-free with high air flow volumes against high resistances. Ideal for maintenance and cleaning.



Efficiency class

F

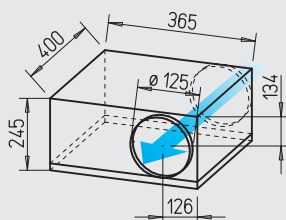

Dim. in mm

SlimVent SVS



Ultra low profile. Ideal for applications with limited installation space. With sound-insulating mineral wool lining for particularly noise-free operation.

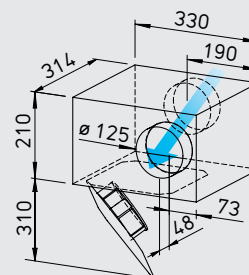

Dim. in mm

■ **Similarities SB and SVS**

□ **Installation**

Installation in any position without restriction – horizontally, vertically or pitched – suitable for intake or extract (Exception: SVS must not be installed with the swing-out motor-impeller unit facing upward).

□ **Motor**

Totally enclosed external rotor motor with ball bearings, impregnated windings insulation class F, designed for continuous operation, maintenance free and interference-free.

■ **Specification SilentBox®**

□ **Casing**

Like an internal attenuator. Acoustically lined with abrasive resistant 50 mm thick mineral fibreboard. Four quick release clamps permit easy access to motor scroll and impeller set.

Swing out motor and impeller. Spigots on intake and exhaust twin-seal rubber gaskets fit standard ducts. All parts manufactured from galvanised sheet steel.

□ **Impeller**

Low noise forward curved centrifugal impeller, housed within an aerodynamically shaped scroll from galvanised steel. Bell mouth shaped inlet ring to achieve optimum air flow.

□ **Electrical connection**

Terminal box (IP 54) is supplied with a 60 cm long electric cable.

□ **Motor protection**

With thermal contacts wired in series with the windings. To reset the thermal contacts the main supply must be switched off and on.

□ **Speed control**

Stepless 0 – 100 % using electronic controller or 5 step transformer controller (see table).

□ **Protection class**

IP 44

■ **Specification SlimVent SVS**

□ **Casing**

Extremely flat casing in longer design with more than 50 mm thick sound-absorbing mineral wool lining and glass fibre surface. The acoustic box which is placed in front of the fan reduces the sound level for the intake significantly. The sound pressure level is reduced to a smaller extent (see sound levels in the tables above the performance curves).

□ The swing out motor and impeller unit permits maintenance and cleaning without disassembly of system components. The swing-out range must be considered for the inspection flap.

□ **Impeller**

Energy-saving centrifugal impeller with backward curved blades from high quality polymer. Dynamically balanced for low noise operation.

□ **Electrical connection**

Terminal box (IP 54) mounted on running cable.

□ **Motor protection**

With thermal contacts wired in series with the windings which automatically reset after cooling.

□ **Speed control**

Stepless 0 – 100 % by use of electronic controller or 5 step transformer controller (see table) or 2 speed operation with DS 2/2 (accessories).

Type DS 2/2 Ref. no. 1267

□ **Protection class**

When installed in ducting the fan is rated IP 44.

Type	Ref. no.	Air flow volume (FID)	R.P.M.	Sound press. case breakout	Motor power	Current		Wiring diagram	max. air flow temp.		Weight net approx.	Transformer-speed controller 5-step		Electronic* speed controller, stepless flush / surface	
		\dot{V} m ³ /h				min ⁻¹	db(A) in 1 m		W	A		A	No.	+°C	+°C
Type SilentBox® SB, 1 ph. motor, 230 V, 50 Hz, capacitor motor, IP 44															
SB 125 A	9506	230	1130	28	61	0.27	0.27	508	80	80	12.0	TSW 0,3	3608	ESU 1 / ESA 1	0236 / 0238
SB 125 C	9562	440	1850	37	122	0.53	0.53	508	65	65	12.0	TSW 1,5	1495	ESU 1 / ESA 1	0236 / 0238
Type SVS, 1 ph. motor, 230 V, 50 Hz, capacitor motor, IP 33															
SVS 125 B	0130	400/270 ¹⁾	2570/1710 ¹⁾	45/36 ¹⁾	61/45 ¹⁾	0.27/0.20 ¹⁾	0.26 ¹⁾	934.1	60	60	5.9	TSW 1,5	1495	ESU 1 / ESA 1	0236 / 0238

¹⁾ Values refer to the two speed stages (see characteristic curve).

* In noise relevant cases, transformer controllers must be provided. An electronic controller can trigger a distracting magnetisation noise.

SB 125 A

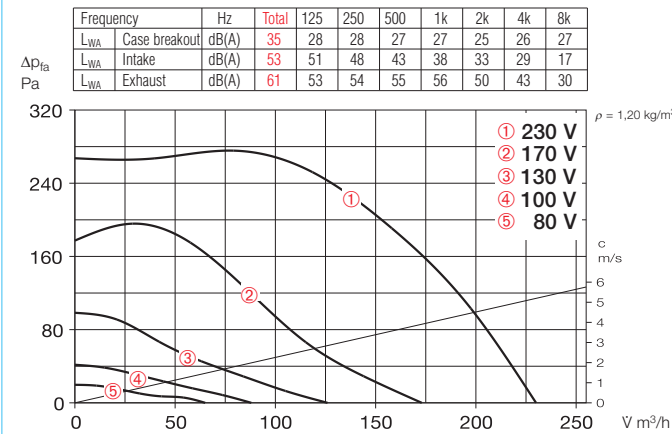

SB 125 C

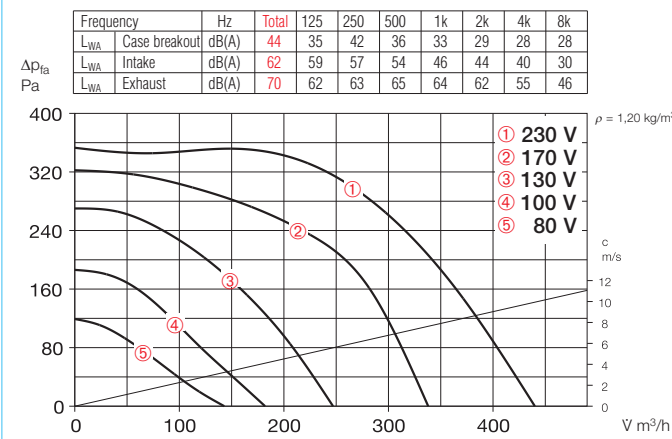

SVS 125 B

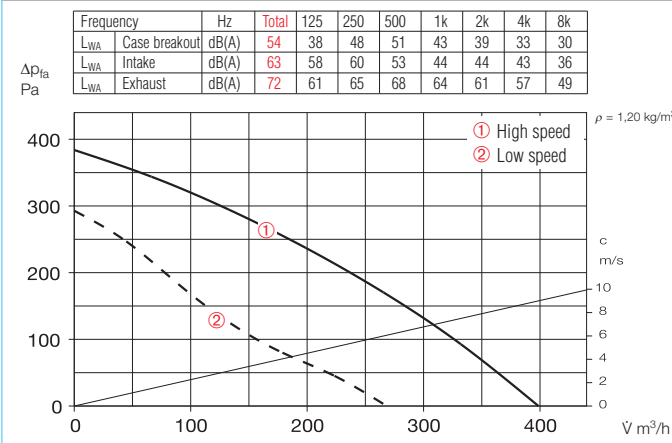

Sound levels

Total sound power levels and the spectrum figures in dB(A) are given for

- Sound level case breakout
- Sound level intake/exhaust

The type table also shows

- Sound pressure case breakout and intake air noise specified as sound pressure in 1 m (free field conditions).

For the SB types, it should be noted that the intake sound level is less than the exhaust sound level.

Accessory details Page

Filters, heater batteries and attenuators	421 on
Temperature control systems for heater batteries	427, 431 on
Flexible ventilation ducting, Grilles, adaptors, roof terminations	487 on
Valves	508 on
Speed controllers, switches	525 on

Accessories

Flexible sleeve

Type FM 125 Ref. no. 1682
Supplied with two hose clips as standard; for installation between fan and duct system. Prevents sound and vibration transmission to ducting and corrects small site misalignments. For intake or extract two sleeves are needed for complete isolation.

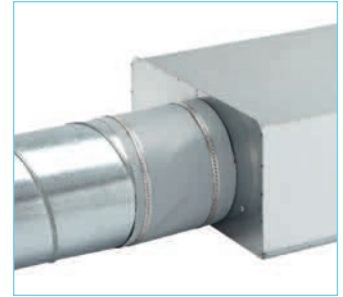

Gravity shutter

Type VK 125 Ref. no. 0857
Automatic made from polymer, white.



Fixed grille

Type G 160 Ref. no. 0893
Made from polymer, white.



Guard

Type SGR 125 Ref. no. 5064
For intake and extract installation. Made from powder-coated steel wire.



Backdraught shutter

Type RSKK 125 Ref. no. 5107
Automatic, made from polymer.



Flexible circular attenuator

Type FSD 125 Ref. no. 0677
Spigotted aluminium attenuator with 50 mm insulation. Length 1 m.



Air filter box

LFBR 125 G4 Ref. no. 8577
LFBR 125 F7 Ref. no. 8531
Air filter with large surface area for installation in ducting.



Electric heater battery

EHR-R 0,8/125 0,8 kW No. 8709
EHR-R 1,2/125 1,2 kW No. 9433
– with integrated temp. control
EHR-R 0,8/125 TR 0,8 kW No. 5293
Room or duct sensor (TFK/TFR, accessories) required.



Temperature control system for electric heater battery EHR-R
Type EHS Ref. no. 5002

Warm water heater battery

Type WHR 125 Ref. no. 9480
Compact heat exchanger for in-line installation.

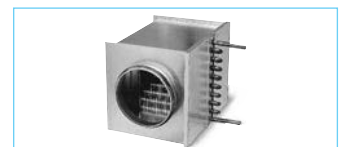

Temperature control system for warm water heater battery
Type WHST 300 T38 No. 8817



SilentBox® SB



Virtually noise-free with high air flow volumes against high resistances. Ideal for maintenance and cleaning.

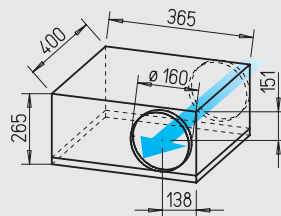

Dim. in mm

SlimVent SVS



Ultra low profile. Ideal for applications with limited installation space. With sound-insulating mineral wool lining for particularly noise-free operation.

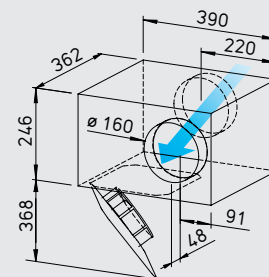

Dim. in mm

■ **Similarities SB and SVS**

□ **Installation**

Installation in any position without restriction – horizontally, vertically or pitched – suitable for intake or extract (Exception: SVS must not be installed with the swing-out motor-impeller unit facing upward).

□ **Motor**

Totally enclosed external rotor motor with ball bearings, impregnated windings insulation class F, designed for continuous operation, maintenance free and interference-free.

□ **Sound levels** See page 359.

■ **Specification SilentBox®**

□ **Casing**

Like an internal attenuator. Acoustically lined with abrasive resistant 50 mm thick mineral fibreboard. Four quick release clamps permit easy access to

motor scroll and impeller set. Swing out motor and impeller. Spigots on intake and exhaust twin-seal rubber gaskets fit standard ducts. All parts manufactured from galvanised sheet steel.

□ **Impeller**

Low noise forward curved centrifugal impeller, housed within an aerodynamically shaped scroll from galvanised steel. Bell mouth shaped inlet ring to achieve optimum air flow.

□ **Electrical connection**

Terminal box (IP 54) is supplied with a 60 cm long electric cable.

□ **Motor protection**

With thermal contacts wired in series with the windings. To reset the thermal contacts the main supply must be switched off and on.

□ **Speed control**

Stepless 0 – 100 % using electronic controller or 5 step transformer controller (see table).

□ **Protection class**

IP 44

■ **Specification SlimVent SVS**

□ **Casing**

Extremely flat casing in longer design with more than 50 mm thick sound-absorbing mineral wool lining and glass fibre surface. The acoustic box which is placed in front of the fan reduces the sound level for the intake significantly. The sound pressure level is reduced to a smaller extent (see sound levels in the tables above the performance curves).

□ The swing out motor and impeller unit permits maintenance and cleaning without disassembly of system components. The

swing-out range must be considered for the inspection flap.

□ **Impeller**

Energy-saving centrifugal impeller with backward curved blades from high quality polymer. Dynamically balanced for low noise operation.

□ **Electrical connection**

Terminal box (IP 54) mounted on running cable.

□ **Motor protection**

With thermal contacts wired in series with the windings which automatically reset after cooling.

□ **Speed control**

Stepless 0 – 100 % by use of electronic controller or 5 step transformer controller (see table) or 2 speed operation with DS 2/2 (accessories).

Type DS 2/2 Ref. no. 1267

□ **Protection class**

When installed in ducting the fan is rated IP 44.

Type	Ref. no.	Air flow volume (FID)	R.P.M.	Sound press. case breakout	Motor power	Current		Wiring diagram	max. air flow temp.		Weight net approx.	Transformer-speed controller 5-step		Electronic* speed controller, stepless flush / surface	
						full load	control		full load	control		Type	Ref. no.	Type	Ref. no.
		∇ m³/h	min⁻¹	db(A) in 1 m	W	A	A	No.	+°C	+°C	kg	Type	Ref. no.	Type	Ref. no.
Type SilentBox® SB, 1 ph. motor, 230 V, 50 Hz, capacitor motor, IP 44 (B), IP 33 (D)															
SB 160 B	9508	360	1650	36	105	0.46	0.46	508	65	65	13.0	TSW 1,5	1495	ESU 1 / ESA 1	0236 / 0238
SB 160 D	9563	580	2220	43	164	0.72	0.72	508	60	60	10.3	TSW 1,5	1495	ESU 1 / ESA 1	0236 / 0238
Type SVS, 1 ph. motor, 230 V, 50 Hz, capacitor motor, IP 33															
SVS 160 K	0131	440/300 ¹⁾	2560/1730 ¹⁾	44/35 ¹⁾	61/45 ¹⁾	0.26/0.20 ¹⁾	0.26 ¹⁾	934.1	60	60	7.6	TSW 1,5	1495	ESU 1 / ESA 1	0236 / 0238
SVS 160 L	2653	670/390 ¹⁾	2520/1530 ¹⁾	50/39 ¹⁾	108/69 ¹⁾	0.47/0.30 ¹⁾	0.45 ¹⁾	934.1	60	60	7.8	TSW 1,5	1495	ESU 1 / ESA 1	0236 / 0238

¹⁾ Values refer to the two speed stages (see characteristic curve).

* In noise relevant cases, transformer controllers must be provided. An electronic controller can trigger a distracting magnetisation noise.

SB 160 B

Frequency	Hz	Total	125	250	500	1k	2k	4k	8k
L _{WA} Case breakout		43	40	39	34	32	28	27	27
L _{WA} Intake		61	59	56	50	44	39	35	26
L _{WA} Exhaust		68	61	61	62	61	58	53	44

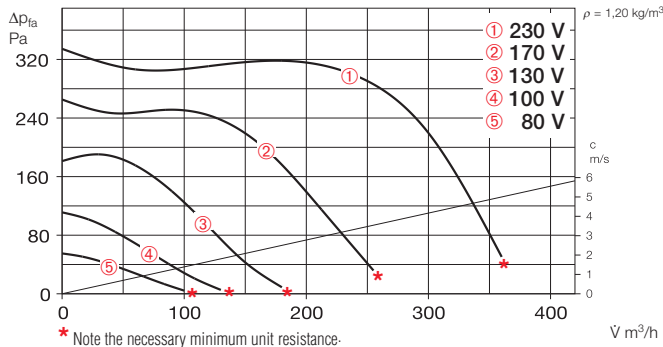

SB 160 D

Frequency	Hz	Total	125	250	500	1k	2k	4k	8k
L _{WA} Case breakout		50	47	44	41	34	32	30	28
L _{WA} Intake		67	65	60	53	44	48	46	45
L _{WA} Exhaust		79	68	71	72	69	71	69	69

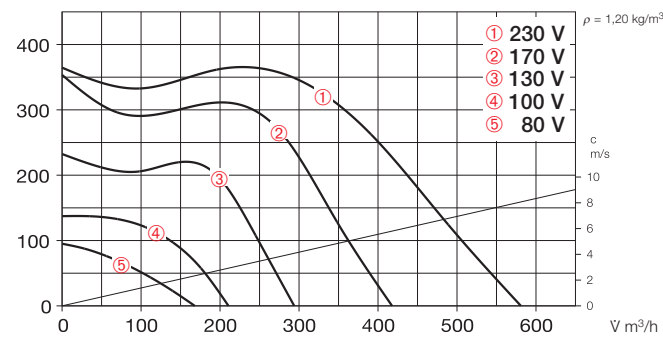

SVS 160 K

Frequency	Hz	Total	125	250	500	1k	2k	4k	8k
L _{WA} Case breakout		52	38	47	50	40	37	32	31
L _{WA} Intake		63	58	61	50	40	45	44	38
L _{WA} Exhaust		70	60	66	65	59	56	56	48

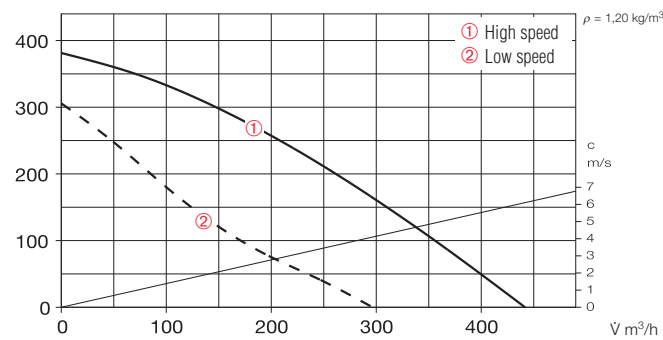

SVS 160 L

Frequency	Hz	Total	125	250	500	1k	2k	4k	8k
L _{WA} Case breakout		58	40	53	55	46	44	38	31
L _{WA} Intake		66	60	64	58	50	47	48	35
L _{WA} Exhaust		75	62	67	73	66	63	63	51

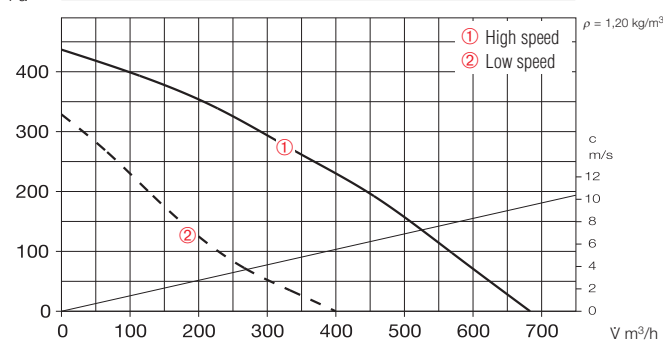

Accessories

Flexible sleeve

Type FM 160 Ref. no. 1684

Supplied with two hose clips as standard; for installation between fan and duct system. Prevents sound and vibration transmission to ducting and corrects small site misalignments. For intake or extract two sleeves are needed for complete isolation.

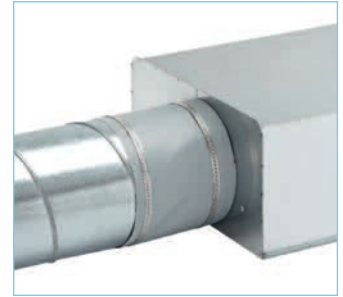

Gravity shutter

Type VK 160 Ref. no. 0892

Automatic made from polymer, white.



Fixed grille

Type G 160 Ref. no. 0893

Made from polymer, white.



Guard

Type SGR 160 Ref. no. 5069

For intake and extract installation. Made from galvanised steel.



Backdraught shutter

Type RSK 160 Ref. no. 5669

Automatic, made from metal.



Flexible circular attenuator

Type FSD 160 Ref. no. 0678

Spigotted aluminium attenuator with 50 mm insulation. Length 1 m.



Air filter box

LFBR 160 G4 Ref. no. 8578

LFBR 160 F7 Ref. no. 8532

Air filter with large surface area for installation in ducting.



Electric heater battery

EHR-R 1,2/160 1,2 kW No. 9434

EHR-R 2,4/160 2,4 kW No. 9435

EHR-R 5/160 5,0 kW No. 8710

- with integrated temp. control

EHR-R 2,4/160 TR 2,4 kW No. 5294

Room or duct sensor (TFK/TFR, accessories) required.



Temperature control system for electric heater battery EHR-R

Type EHS Ref. no. 5002

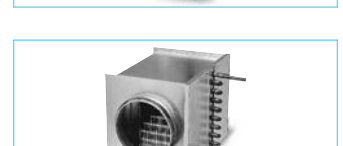

Warm water heater battery

Type WHR 160 Ref. no. 9481

Compact heat exchanger for in-line installation.



Temperature control system for warm water heater battery

Type WHST 300 T38 No. 8817

SilentBox® SB



Virtually noise-free with high air flow volumes against high resistances. Ideal for maintenance and cleaning.

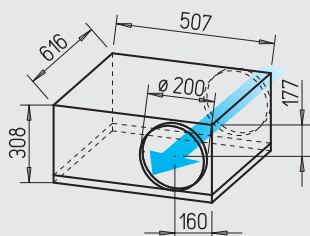

Dim. in mm

SlimVent SVS



Ultra low profile. Ideal for applications with limited installation space. With sound-insulating mineral wool lining for particularly noise-free operation.

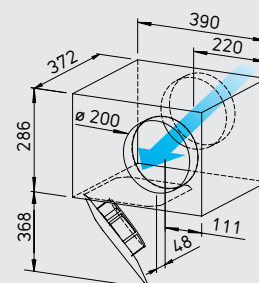

Dim. in mm

■ **Similarities SB and SVS**

□ **Installation**

Installation in any position without restriction – horizontally, vertically or pitched – suitable for intake or extract (Exception: SVS must not be installed with the swing-out motor-impeller unit facing upward).

□ **Motor**

Totally enclosed external rotor motor with ball bearings, impregnated windings insulation class F, designed for continuous operation, maintenance free and interference-free.

■ **Specification SilentBox®**

□ **Casing**

Like an internal attenuator. Acoustically lined with abrasive resistant 50 mm thick mineral fibreboard. Four quick release clamps permit easy access to motor scroll and impeller set. Swing out motor and impeller.

Spigots on intake and exhaust twin-seal rubber gaskets fit standard ducts. All parts manufactured from galvanised sheet steel.

□ **Impeller**

With backward curved high-quality polymer blades. Inflow via inlet cone.

□ **Electrical connection**

Terminal box (IP 54) is supplied with a 60 cm long electric cable.

□ **Motor protection**

With thermal contacts wired in series with the windings. To reset the thermal contacts the main supply must be switched off and on.

□ **Speed control**

Stepless 0 – 100 % using electronic controller or 5 step transformer controller (see table).

□ **Protection class**

IP 44

■ **Specification SlimVent SVS**

□ **Casing**

Extremely flat casing in longer design with more than 50 mm thick sound-absorbing mineral wool lining and glass fibre surface. The acoustic box which is placed in front of the fan reduces the sound level for the intake significantly. The sound pressure level is reduced to a smaller extent (see sound levels in the tables above the performance curves).

□ The swing out motor and impeller unit permits maintenance and cleaning without disassembly of system components. The swing-out range must be considered for the inspection flap.

□ **Impeller**

Energy-saving centrifugal impeller with backward curved blades from high quality polymer. Dynamically balanced for low noise operation.

□ **Electrical connection**

Terminal box (IP 54) mounted on running cable.

□ **Motor protection**

With thermal contacts wired in series with the windings which automatically reset after cooling.

□ **Speed control**

Stepless 0 – 100 % by use of electronic controller or 5 step transformer controller (see table).

□ **Protection class**

When installed in ducting the fan is rated IP 44.

Information	Page
Techn. description	296
Selection chart	297
Information for planning	10 on
Modular system	294

Type	Ref. no.	Air flow volume (FID)	R.P.M.	Sound press. case breakout	Motor power	Current		Wiring diagram	max. air flow temp.		Weight net approx.	Transformer-speed controller 5-step	Electronic* speed controller, stepless flush / surface		
						full load	control		full load	control			Type	Ref. no.	Type
Type SilentBox® SB, 1 ph. motor, 230 V, 50 Hz, capacitor motor, IP 33															
SB 200 C	9510	810	2520	44	105	0.46	0.46	508	70	70	19.0	TSW 1,5	1495	ESU 1 / ESA 1	0236 / 0238
SB 200 D	9564	1030	2700	48	160	0.69	0.83	508	70	50	19.7	TSW 1,5	1495	ESU 1 / ESA 1	0236 / 0238
Type SVS, 1 ph. motor, 230 V, 50 Hz, capacitor motor, IP 33															
SVS 200 K	0132	940	2710	55	163	0.71	0.83	508	70	50	9.2	TSW 1,5	1495	ESU 1 / ESA 1	0236 / 0238

* In noise relevant cases, transformer controllers must be provided. An electronic controller can trigger a distracting magnetisation noise.

SB 200 C

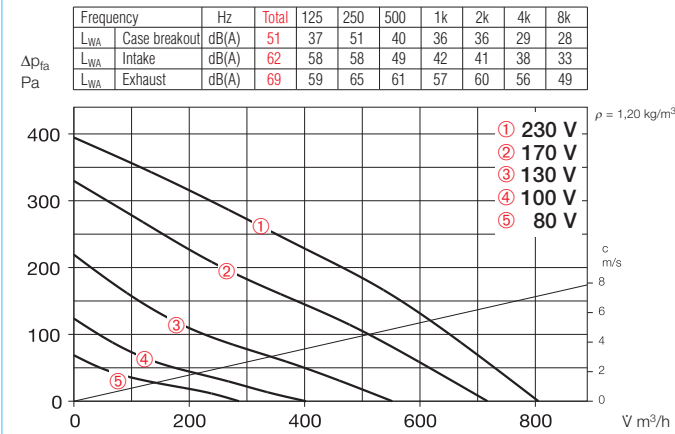

SB 200 D

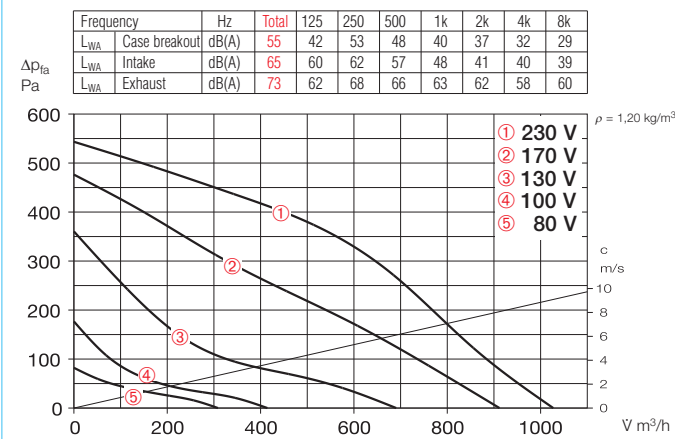

SVS 200 K

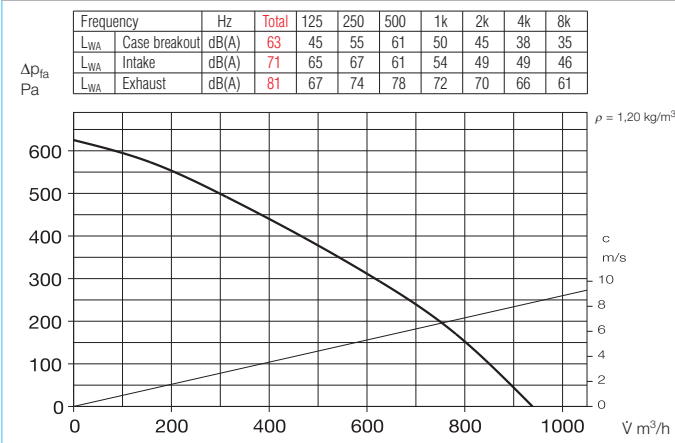

Sound levels

Total sound power levels and the spectrum figures in dB(A) are given for

- Sound level case breakout
- Sound level intake/exhaust

The type table also shows

- Sound pressure case breakout and intake air noise specified as sound pressure in 1 m (free field conditions).

For the SB types, it should be noted that the intake sound level is less than the exhaust sound level.

Accessory details Page

Filters, heater batteries and attenuators	421 on
Temperature control systems for heater batteries	427, 431 on
Flexible ventilation ducting, Grilles, adaptors, roof terminations	487 on
Valves	508 on
Speed controllers, switches	525 on

Accessories

Flexible sleeve

Type FM 200 Ref. no. 1670
Supplied with two hose clips as standard; for installation between fan and duct system. Prevents sound and vibration transmission to ducting and corrects small site misalignments. For intake or extract two sleeves are needed for complete isolation.

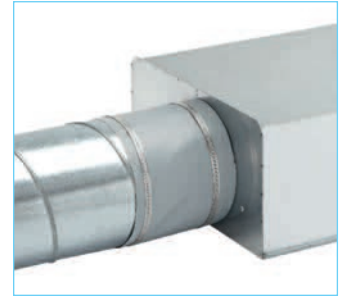

Gravity shutter

Type VK 200 Ref. no. 0758
Automatic made from polymer, light grey.



Fixed grille

Type RAG 200 Ref. no. 0750
For covering air inlets and outlets on facades. Made from polymer, light grey.



Guard

Type SGR 200 Ref. no. 5066
For intake and extract installation. Made from galvanised steel.



Backdraught shutter

Type RSK 200 Ref. no. 5074
Automatic, made from metal.



Flexible circular attenuator

Type FSD 200 Ref. no. 0679
Spigotted aluminium attenuator with 50 mm insulation. Length 1 m.



Air filter box

LFBR 200 G4 Ref. no. 8579
LFBR 200 F7 Ref. no. 8533
Air filter with large surface area for installation in ducting.



Electric heater battery

EHR-R 1,2/200 1,2 kW No. 9436
EHR-R 2/200 2,0 kW No. 9437
EHR-R 5/200 5,0 kW No. 8711
– with integrated temp. control
EHR-R 5/200 TR 5,0 kW No. 5295
Room or duct sensor (TFK/TFR, accessories) required.



Temperature control system for electric heater battery EHR-R
Type EHS Ref. no. 5002

Warm water heater battery

Type WHR 200 Ref. no. 9482
Compact heat exchanger for in-line installation.

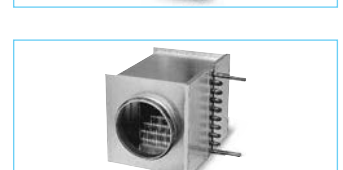

Temperature control system for warm water heater battery
Type WHST 300 T38 No. 8817



SilentBox® SB 250 C



Virtually noise-free with high air flow volumes against high resistances. Ideal for maintenance and cleaning.

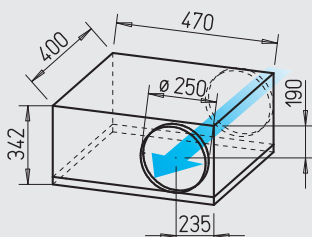

Dim. in mm

SilentBox® SB 250 E



Virtually noise-free with high air flow volumes against high resistances. Ideal for maintenance and cleaning.

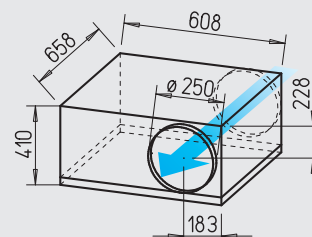

Dim. in mm

Similarities
SB 250 C and E

Installation

Installation in any position without restriction – horizontally, vertically or pitched – suitable for intake or extract.

Motor

Totally enclosed external rotor motor with ball bearings, impregnated windings insulation class F, designed for continuous operation, maintenance free and interference-free.

Motor protection

With thermal contacts wired in series with the windings. To reset the thermal contacts the main supply must be switched off and on.

Speed control

Stepless 0 – 100 % by use of electronic controller or 5 step transformer controller (see table).

Electrical connection

Terminal box (IP 54) is supplied with a 60 cm long electric cable.

Protection class

IP 44.

Specification SB 250 C

Casing

Like an internal attenuator. Acoustically lined with abrasive resistant 50 mm thick mineral fibreboard. For quick release clamps permit easy access to motor scroll and impeller set. Extractable motor and impeller unit. Spigots on intake and exhaust twin-seal rubber gaskets fit standard ducts. All parts manufactured from galvanised sheet steel.

Impeller

Low noise forward curved centrifugal impeller, housed within an aero dynamically shaped scroll from galvanised steel. Bell mouth shaped inlet ring to achieve optimum air flow.

Specification SB 250 E

Casing

Acoustically lined with abrasive resistant 50 mm thick mineral fibreboard. Four quick release clamps permit easy access to motor scroll and impeller set. Swing out motor and impeller unit. Spigots on intake and exhaust twin-seal rubber gaskets fit standard ducts. All parts manufactured from galvanised sheet steel.

Impeller

Low noise forward curved centrifugal impeller, housed within an aerodynamically shaped scroll from galvanised steel. Bell mouth shaped inlet ring to achieve optimum air flow.

Information	Page
Techn. description	296
Selection chart	297
Information for planning Modular system	10 on 294

Type	Ref. no.	Air flow volume (FID)	R.P.M.	Sound press. case breakout	Motor power	Current		Wiring diagram	max. air flow temp.		Weight net approx.	Transformer-speed controller 5-step		Electronic* speed controller, stepless flush / surface	
						full load	control		full load	control		Type	Ref. no.	Type	Ref. no.
Type SilentBox® SB, 1 ph. motor, 230 V, 50 Hz, capacitor motor, IP 44 (C), IP 33 (E)															
SB 250 C	9512	960	2120	43	255	1.13	1.13	508	50	50	18.0	TSW 1,5	1495	ESU 3 / ESA 3	0237 / 0239
SB 250 E	9565	1080	2690	45	165	0.71	0.86	508	70	50	33.4	TSW 1,5	1495	ESU 1 / ESA 1	0236 / 0238

* In noise relevant cases, transformer controllers must be provided. An electronic controller can trigger a distracting magnetisation noise.

SB 250 C

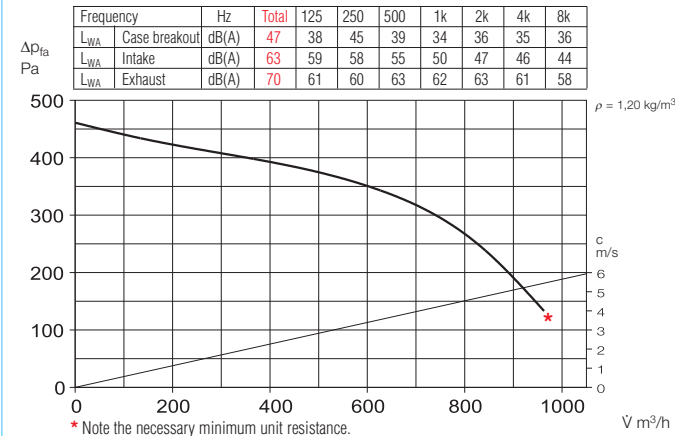

SB 250 E

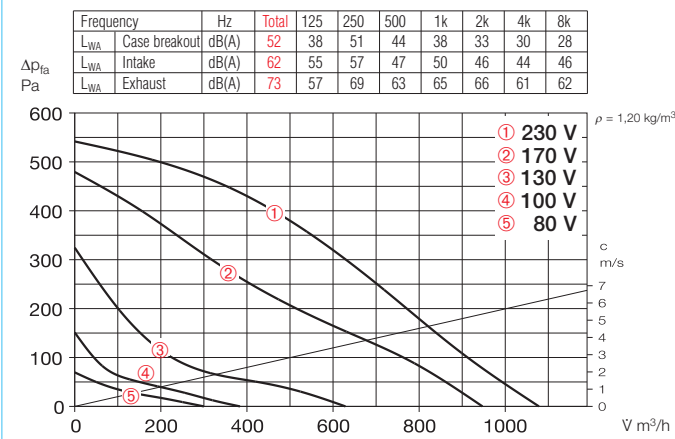

Sound levels

Total sound power levels and the spectrum figures in dB(A) are given for

- Sound level case breakout
- Sound level intake/exhaust

The type table also shows

- Sound pressure case breakout and intake air noise specified as sound pressure in 1 m (free field conditions).

It should be noted that the intake sound level is less than the exhaust sound level.

Accessory details Page

Filters, heater batteries and attenuators	421 on
Temperature control systems for heater batteries	427, 431 on
Flexible ventilation ducting, Grilles, adaptors, roof terminations	487 on
Valves	508 on
Speed controllers, switches	525 on

Accessories

Flexible sleeve

Type FM 250 Ref. no. 1672
Supplied with two hose clips as standard; for installation between fan and duct system. Prevents sound and vibration transmission to ducting and corrects small site misalignments. For intake or extract two sleeves are needed for complete isolation.

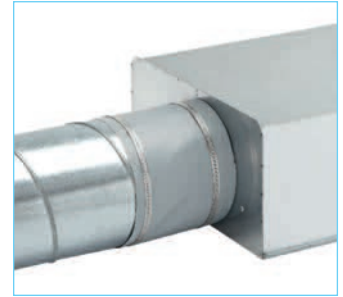

Gravity shutter

Type VK 250 Ref. no. 0759
Automatic made from polymer, light grey.



Fixed grille

Type RAG 250 Ref. no. 0751
For covering air inlets and outlets on facades. Made from polymer, light grey.



Guard

Type SGR 250 Ref. no. 5067
For intake and extract installation. Made from galvanised steel.



Backdraught shutter

Type RSK 250 Ref. no. 5673
Automatic, made from metal.



Flexible circular attenuator

Type FSD 250 Ref. no. 0680
Spigotted aluminium attenuator with 50 mm insulation. Length 1 m.



Air filter box

LFBR 250 G4 Ref. no. 8580
LFBR 250 F7 Ref. no. 8534
Air filter with large surface area for installation in ducting.

Electric heater battery

EHR-R 6/250 6,0 kW No. 8712
– with integrated temp. control
EHR-R 6/250 TR 6,0 kW No. 5296
Room or duct sensor (TFK/TFR, accessories) required.



Temperature control system for electric heater battery EHR-R
Type EHS Ref. no. 5002



Warm water heater battery

Type WHR 250 Ref. no. 9483
Compact heat exchanger for in-line installation.

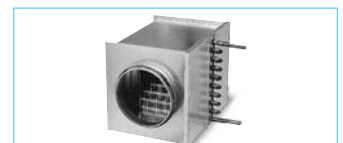

Temperature control system for warm water heater battery
Type WHS HE Ref. no. 8319



SilentBox® SB 315 and SBD 315 A



Virtually noise-free with high air flow volumes against high resistances. Ideal for maintenance and cleaning.

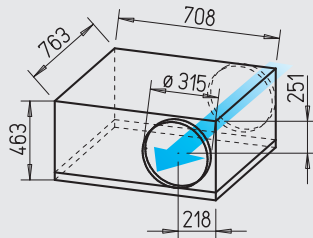

Dim. in mm

SilentBox® SBD 315 B



Virtually noise-free with high air flow volumes against high resistances. Ideal for maintenance and cleaning.

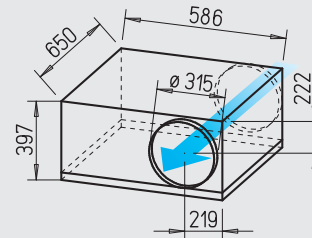

Dim. in mm

■ **Similarities**
SB 315, SBD 315 A and B

□ **Installation**

Installation in any position without restriction – horizontally, vertically or pitched – suitable for intake or extract.

□ **Impeller**

SB 315 and SBD 315 A with backward curved high-quality polymer blades. Inflow via inlet cone. SBD 315 B as described on the right.

□ **Motor**

Totally enclosed external rotor motor with ball bearings, impregnated windings insulation class F, designed for continuous operation, maintenance free and interference-free.

□ **Motor protection**

With thermal contacts wired to the terminal block and must be connected to a motor protection unit (see type table).

□ **Speed control**

Through voltage reduction by means of 5 step transformer or electronic controller (stepless).

□ **Electrical connection**

Terminal box (IP 54) is supplied with a 60 cm long electric cable.

□ **Protection class**

IP 54.

■ **Specification**
SB 315 and SBD 315 A

□ **Casing**

Like an internal attenuator. Acoustically lined with abrasive resistant 50 mm thick mineral fibreboard. Four quick release clamps permit easy access to motor scroll and impeller set. Swing out motor and impeller unit. Spigots on intake and exhaust twin-seal rubber gaskets fit standard ducts. All parts manufactured from galvanised sheet steel.

■ **Specification SBD 315 B**

□ **Casing**

Like an internal attenuator. Acoustically lined with abrasive resistant 50 mm thick mineral fibreboard. Four quick release clamps permit easy access to motor scroll and impeller set. Fan and spiral casing freely accessible. Swing out motor and impeller unit. Spigots on intake and exhaust twin-seal rubber gaskets fit standard ducts. All parts manufactured from galvanised sheet steel.

□ **Impeller**

Low noise forward curved centrifugal impeller, housed within an aerodynamically shaped scroll from galvanised steel. Bell mouth shaped inlet ring to achieve optimum air flow.

Type	Ref. no.	Air flow volume (FID)	R.P.M.	Sound press. case breakout	Motor power	Current		Wiring diagram	max. air flow temp.		Weight net approx.	Speed controller 5-step			
						full load	control		full load	control		Type	Ref. no.	Type	Ref. no.
		m³/h	min⁻¹	db(A) in 1 m	W	A	A	No.	+°C	+°C	kg	Type	Ref. no.	Type	Ref. no.
Type SilentBox® SB, 1 ph. motor, 230 V, 50 Hz, capacitor motor, IP 54															
SB 315	9515	2420	1420	51	310	1.70	1,80	536.1	60	60	45	TSW 3,0 ¹⁾	1496	—	—
Type SilentBox® SBD, 3 ph. motor, 230/400 V, 50 Hz, IP 54															
SBD 315 A	9718	2200	1350	47	215	0.73/0.42	0.44	860	60	60	46.0	TSD 0,8 ²⁾	1500	RDS 1	1314
SBD 315 B	9583	2250	1290	50	640	2.40/1.40	1.40	860	60	60	43.4	TSD 3,0 ²⁾	1502	RDS 2	1315

1) required full motor protection device, Type MW, No. 1579, see accessories.

2) required full motor protection device, Type MD, No. 5849, see accessories.

SB 315

Frequency	Hz	Total	125	250	500	1k	2k	4k	8k
L _{WA} Case breakout		dB(A) 58	52	56	42	38	33	31	27
L _{WA} Intake		dB(A) 66	63	62	47	40	40	36	33
L _{WA} Exhaust		dB(A) 74	69	69	60	64	58	53	45

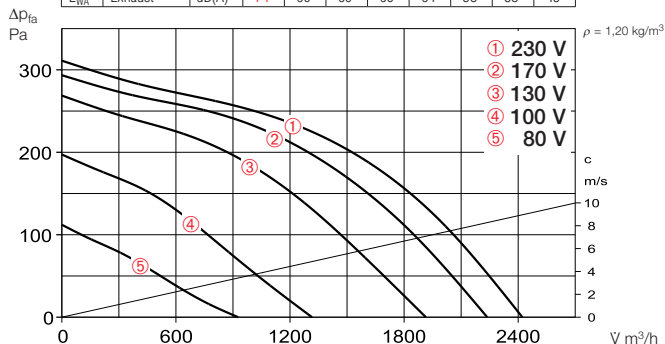

SBD 315 A

Frequency	Hz	Total	125	250	500	1k	2k	4k	8k
L _{WA} Case breakout		dB(A) 54	51	51	37	36	31	29	28
L _{WA} Intake		dB(A) 64	62	57	41	35	35	32	29
L _{WA} Exhaust		dB(A) 70	68	64	53	53	51	50	38

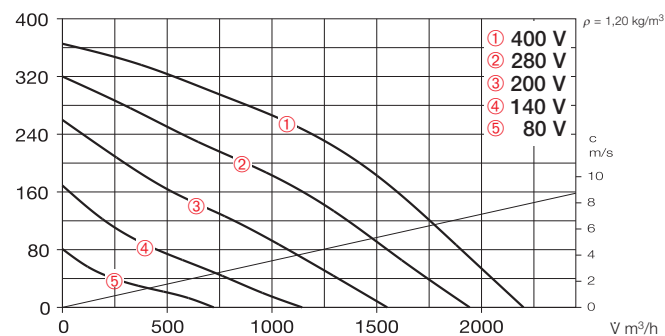

SBD 315 B

Frequency	Hz	Total	125	250	500	1k	2k	4k	8k
L _{WA} Case breakout		dB(A) 57	54	52	46	44	41	38	31
L _{WA} Intake		dB(A) 69	66	63	50	53	54	50	46
L _{WA} Exhaust		dB(A) 85	70	73	77	79	79	77	71

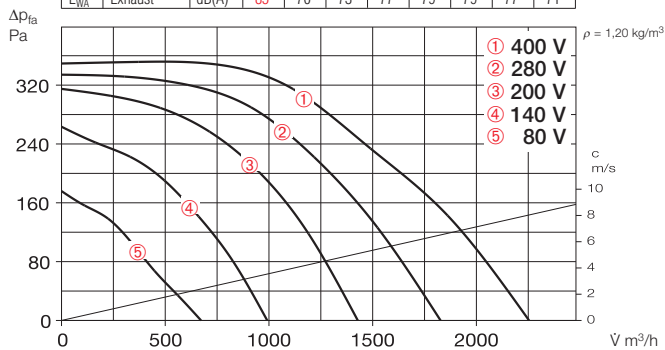

Sound levels

Total sound power levels and the spectrum figures in dB(A) are given for

- Sound level case breakout
- Sound level intake/exhaust

The type table also shows

- Sound pressure case breakout and intake air noise specified as sound pressure in 1 m (free field conditions).

It should be noted that the intake sound level is less than the exhaust sound level.

Accessory details Page

Filters, heater batteries and attenuators	421 on
Temperature control systems for heater batteries	427, 431 on
Flexible ventilation ducting, Grilles, adaptors, roof terminations	487 on
Valves	508 on
Speed controllers, switches	525 on

Accessories

Flexible sleeve

Type FM 315 Ref. no. 1674
 Supplied with two hose clips as standard; for installation between fan and duct system. Prevents sound and vibration transmission to ducting and corrects small site misalignments. For intake or extract two sleeves are needed for complete isolation.

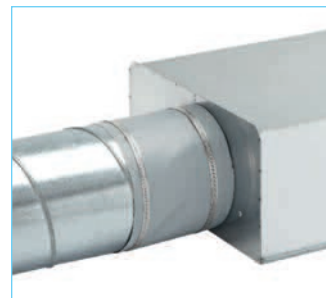

Gravity shutter

Type VK 315 Ref. no. 0760
 Automatic made from polymer, light grey.



Fixed grille

Type RAG 315 Ref. no. 0752
 For covering air inlets and outlets on facades. Made from polymer, light grey.



Guard

Type SGR 315 Ref. no. 5068
 For intake and extract installation. Made from galvanised steel.



Backdraught shutter

Type RSK 315 Ref. no. 5674
 Automatic, made from metal.



Flexible circular attenuator

Type FSD 315 Ref. no. 0681
 Spigotted aluminium attenuator with 50 mm insulation. Length 1 m.



Air filter box

LFBR 315 G4 Ref. no. 8581
LFBR 315 F7 Ref. no. 8535
 Air filter with large surface area for installation in ducting.



Electric heater battery

EHR-R 6/315 6,0 kW No. 8713
 – with integrated temp. control
EHR-R 6/315 TR 6,0 kW No. 5301
 Room or duct sensor (TFK/TFR, accessories) required.



Temperature control system for electric heater battery EHR-R
Type EHS Ref. no. 5002

Warm water heater battery

Type WHR 315 Ref. no. 9484
 Compact heat exchanger for in-line installation.

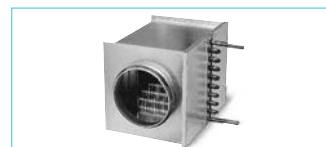

Temperature control system for warm water heater battery
Type WHS HE Ref. no. 8319



SilentBox® SB 355 and SB 400



Virtually noise-free with high air flow volumes against high resistances. Ideal for maintenance and cleaning.

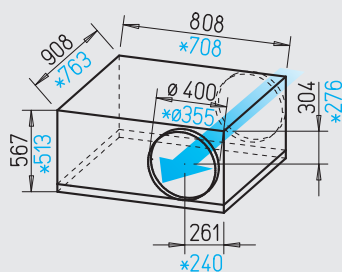

Dim. in mm

*SB 355, SB 400

SilentBox® SBD 355 and SBD 400



Virtually noise-free with high air flow volumes against high resistances. Ideal for maintenance and cleaning.

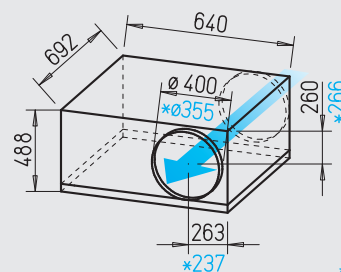

Dim. in mm

*SBD 355, SBD 400

■ **Similarities**
SB 355 and SB 400,
SBD 355 and SBD 400

□ **Installation**

Installation in any position without restriction – horizontally, vertically or pitched – suitable for intake or extract. Make sure that there is free accessibility to the cover. To keep sound levels inside the ventilated rooms as low as possible we recommend the fan is installed as remote as possible.

□ **Motor**

Totally enclosed external rotor motor with ball bearings, impregnated windings insulation class F, designed for continuous operation, maintenance free and interference-free.

□ **Motor protection**

With thermal contacts wired to the terminal block and must be connected to a motor protection unit (see type table).

□ **Speed control**

Through voltage reduction by means of 5 step transformer or electronic controller (stepless).

□ **Electrical connection**

Terminal box (IP 54) is supplied with a 60 cm long electric cable.

□ **Protection class**

IP 54.

□ **Sound levels**

See page 367.

■ **Specification**
SB 355 and SB 400

□ **Casing**

Like an internal attenuator. Acoustically lined with abrasive resistant 50 mm thick mineral fibreboard. Four quick release clamps permit easy access to motor scroll and impeller set. Swing out motor and impeller unit. Spigots on intake and exhaust twin-seal rubber gaskets fit standard ducts. All parts manufactured from galvanised sheet steel.

□ **Impeller**

Backward curved high-quality polymer impeller. Inflow via inlet cone.

■ **Specification**
SBD 355 and SBD 400

□ **Casing**

Like an internal attenuator. Acoustically lined with abrasive resistant 50 mm thick mineral fibreboard. Four quick release clamps permit easy access to motor scroll and impeller set. Fan and spiral casing freely accessible. Swing out motor and impeller unit. Spigots on intake and exhaust twin-seal rubber gaskets fit standard ducts. All parts manufactured from galvanised sheet steel.

□ **Impeller**

Low noise forward curved centrifugal impeller, housed within an aerodynamically shaped scroll from galvanised steel. Bell mouth shaped inlet ring to achieve optimum air flow.

Type	Ref. no.	Air flow volume (FID)	R.P.M.	Sound press. case breakout	Motor power	Current		Wiring diagram	max. air flow temp.		Weight net approx.	Speed controller 5-step			
						full load	control		full load	control		Type	Ref. no.	Type	Ref. no.
		V m ³ /h	min ⁻¹	db(A) in 1 m	W	A	A	No.	+°C	+°C	kg	Type	Ref. no.	Type	Ref. no.
Type SilentBox® SB, 1 ph. motor, 230 V, 50 Hz, capacitor motor, IP 54															
SB 355	6158	2960	1400	52	345	1.8	1.9	536.1	60	60	47.0	TSW 3,0 ¹⁾	1496	—	—
SB 400	6159	3930	1320	51	500	2.3	2.5	536.1	60	60	61.0	TSW 3,0 ¹⁾	1496	—	—
Type SilentBox® SBD, 3 ph. motor, 230/400 V, 50 Hz, IP 54															
SBD 355	9969	3330	1310	51	1470	4.6/2.6	2.8	860	45	45	47.0	TSD 5,5 ²⁾	1503	RDS 7	1578
SBD 400	9623	3450	1310	50	1470	4.6/2.6	2.7	860	45	45	47.0	TSD 5,5 ²⁾	1503	RDS 7	1578

1) required full motor protection device, Type MW, No. 1579, see accessories.

2) required full motor protection device, Type MD, No. 5849, see accessories.

SB 355

Frequency	Hz	Total	125	250	500	1k	2k	4k	8k
L _{WA} Case breakout		dB(A) 59	53	58	44	38	33	30	27
L _{WA} Intake		dB(A) 70	69	63	48	43	42	38	34
L _{WA} Exhaust		dB(A) 75	71	71	62	65	61	55	48

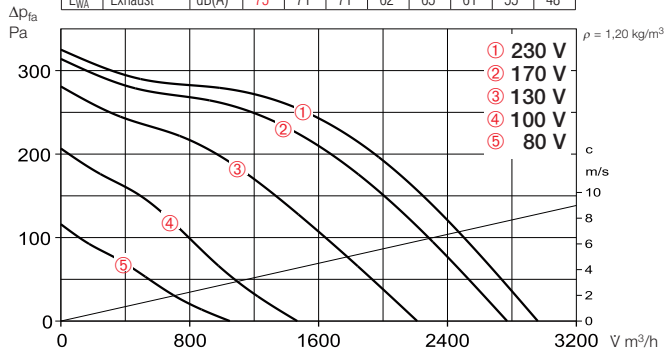

SB 400

Frequency	Hz	Total	125	250	500	1k	2k	4k	8k
L _{WA} Case breakout		dB(A) 58	54	55	45	39	36	33	29
L _{WA} Intake		dB(A) 69	66	62	54	47	44	39	37
L _{WA} Exhaust		dB(A) 75	70	70	62	67	61	57	49

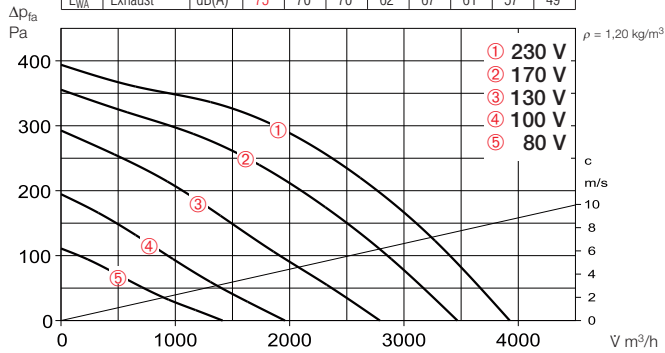

SBD 355

Frequency	Hz	Total	125	250	500	1k	2k	4k	8k
L _{WA} Case breakout		dB(A) 58	51	55	46	46	44	42	35
L _{WA} Intake		dB(A) 72	68	64	53	58	61	59	57
L _{WA} Exhaust		dB(A) 87	71	75	77	80	82	80	74

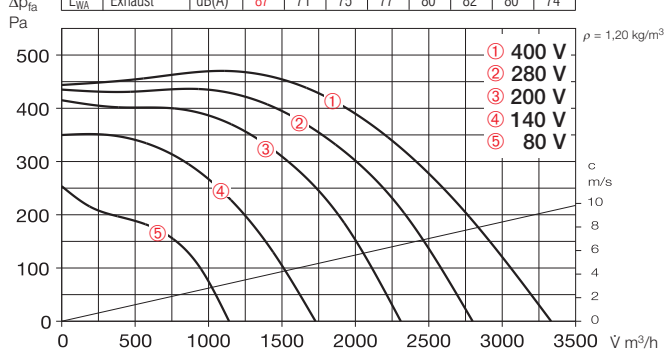

SBD 400

Frequency	Hz	Total	125	250	500	1k	2k	4k	8k
L _{WA} Case breakout		dB(A) 57	50	54	48	47	44	41	34
L _{WA} Intake		dB(A) 72	68	65	53	58	59	55	50
L _{WA} Exhaust		dB(A) 91	77	80	79	86	86	84	77

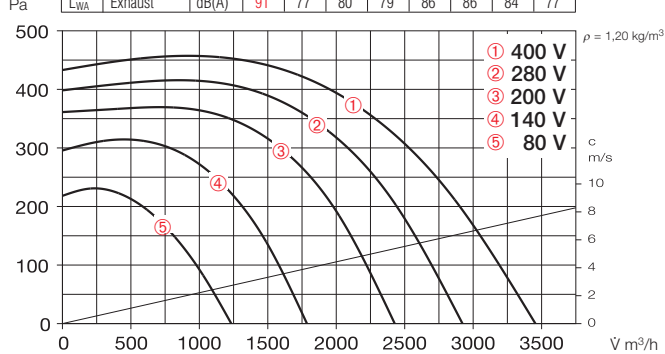

Accessories

Flexible sleeve

- Type FM 355 Ref. no. 1675
- Type FM 400 Ref. no. 1676

Supplied with two hose clips as standard; for installation between fan and duct system. Prevents sound and vibration transmission to ducting and corrects small site misalignments. For intake or extract two sleeves are needed for complete isolation.

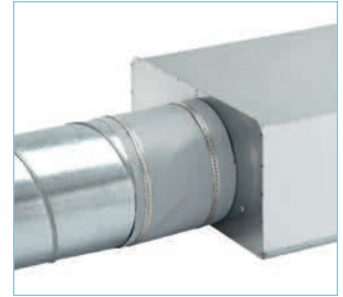

Gravity shutter

- Type VK 355 Ref. no. 0761
- Type VK 400 Ref. no. 0762

Automatic made from polymer, light grey.



Fixed grille

- Type RAG 355 Ref. no. 0753
- Type RAG 400 Ref. no. 0754

For covering air inlets and outlets on facades. Made from polymer, light grey.



Backdraught shutter

- Type RSK 355 Ref. no. 5650
 - Type RSK 400 Ref. no. 5651
- Automatic, made from metal.



Flexible circular attenuator

- Type FSD 355 Ref. no. 0682
- Type FSD 400 Ref. no. 0683

Spigotted aluminium attenuator with 50 mm insulation. Length 1 m.



Air filter box

- LFBR 355 G4 Ref. no. 8583
- LFBR 355 F7 Ref. no. 8536
- LFBR 400 G4 Ref. no. 8582
- LFBR 400 F7 Ref. no. 8537

Air filter with large surface area and capacity for installation in ducting. Connections with double lip seals, adapted to standard Ø.



Electric heater battery

- EHR-R 9/355 9,0 kW No. 8656
- EHR-R 9/400 9,0 kW No. 8657
- with integrated temp. control
- EHR-R 9/355 TR 9,0 kW No. 5297
- EHR-R 9/400 TR 9,0 kW No. 5299

Room or duct sensor (TFK/TFR, accessories) required.



- Temperature control system for electric heater battery EHR-R
- Type EHSD 16 Ref. no. 5003



Warm water heater battery

- Type WHR 355 Ref. no. 8790
- Type WHR 400 Ref. no. 9524

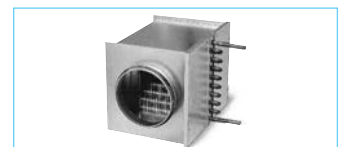

- Temperature control system for warm water heater battery
- Type WHS HE Ref. no. 8319



Perfectly coordinated system solutions from the leading supplier.

- The components are available in every size and every performance level.
- All the components are compatible with each other and fit exactly together.
- Short installation time, simple design and rational procurement.

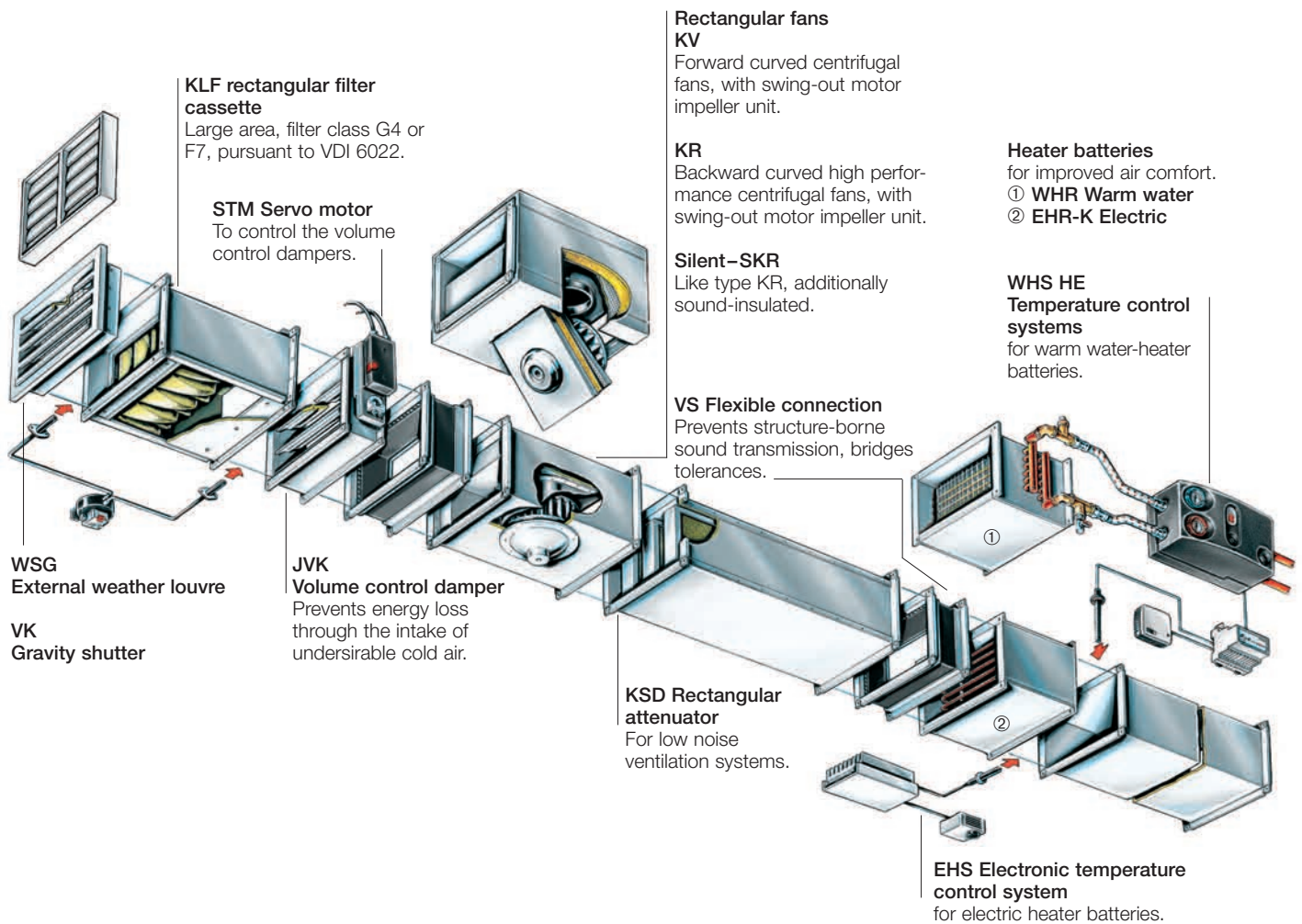

RECTANGULAR CENTRIFUGAL FANS
Selection table
Product-specific information

372

FORWARD CURVED InlineVent® rectangular fans KV



Ø 200 – 450 mm
40 x 20 cm – 100 x 50 cm
V̇ = 920 – 8500 m³/h

374^{on}

BACKWARD CURVED InlineVent® rectangular fans KR



Energy-efficient
EC version KR EC

Ø 180 – 560 mm
30 x 15 cm – 100 x 50 cm
V̇ = 660 – 14 410 m³/h

390^{on}

Standard AC types KR

Ø 180 – 630 mm
30 x 15 cm – 100 x 50 cm
V̇ = 540 – 12 100 m³/h

406^{on}

SOUND-INSULATED rectangular fans Backward curved Acoustic Line SKR



Energy-efficient
EC version SKR EC

Ø 315 – 560 mm
50 x 25 cm – 100 x 50 cm
V̇ = 2600 – 13 700 m³/h

394^{on}

Standard AC types SKR

Ø 315 – 630 mm
50 x 25 cm – 100 x 50 cm
V̇ = 1770 – 9540 m³/h

410^{on}

ACCESSORIES for InlineVent® rectangular fans

420

For complete information see the “general technical information” and descriptions on the product pages.

Position, installation and drainage holes

Models can be installed in any position, however types KR must be installed with the inspection flap facing downwards or to the side. The swing-out areas need to be cleared and accessed easily for service and maintenance.

If condensation occurs (e.g. intermittent operation, high humidity or varying temperatures) the fan must be installed in a way that the condensation can drain off unhindered. Additional holes may have to be drilled into the casing at the appropriate positions. Alternatively, the duct system may have to be insulated to avoid condensation.

Noise/vibration transmission

To be prevented from ducting and building. Therefore, the fan should be secured with sound insulation and connected flexibly to the ducting. For this, see VS accessories.

Explosion proof models

With regards to operating conditions and norms please refer to chapter “Information for planning – explosion proof”. The explosion-protected types correspond to unit group II, category 2G for operation in zone 1 and 2 pursuant to Directive 2014/34/EU (ATEX). The motors of the KVD Ex range are equipped with positive temperature coefficient (PTC) thermistors (to monitor the temperature of windings) as standard. They are prewired to the terminal board and must be connected to the motor protection tripping unit MSA.

This makes the KVD Ex fans suitable for speed control that can be carried out via TSD or TSSD transformer controllers. The minimum voltage should not drop below 100 V. Electronic speed control or regulation by means of a frequency inverter are not permitted.

Motor - Impeller

All AC types incorporate a motor with external rotor motor protected to IP 44 or IP 54 within the air flow. They conform to DIN EN 60034/VDE 0530 and DIN EN 60335-1/VDE 0700-1 with an insulation class F, plus moisture protection.

The EC types are equipped with energy-saving, speed-controllable EC external rotor motors protected to IP 44 or IP 54 for the lowest operating costs.

All motors are maintenance free, interference-free, speed controllable and suitable for continuous operation.

The ball bearings are greased for life.

The centrifugal impellers are pressed onto the rotating part of the motor body and dynamically balanced to DIN ISO 1940 T.1 – class 6.3 as one unit.

Speed control

All InlineVent® AC rectangular fans are speed controllable via voltage reduction of 0 – 100%. Thereby the operating level can be adapted to the required air flow volume. Our speed controllers are suitable to control various fans (one or more) up to their maximum nominal output. When selecting a controller not shown on the chart, allow for a 10% safety margin.

It is possible to control 3 ph.-fans through frequency inverter by on-site installation of sine filters between inverter and motor.

All EC types are steplessly controllable via speed-potentiometer. Regulation is also possible via three-step switch or steplessly via universal control system or electronic differential pressure/temperature controller. For example, the performance levels are shown on the characteristic curve.

Air flow direction

The air flow direction of centrifugal fans is fixed and cannot be reversed; but it can be specified in all units through the installation method. The rotational direction and the direction of air flow are marked with arrows on the units and must be checked when installing.

Incorrect direction of rotation

If the fan is operated in the incorrect direction of rotation the AC motor will be overloaded and the thermal contacts will trip. Typical indication of this is a virtually low fan efficiency combined with high noise levels and vibration.

Air flow temperature

All models are applicable in the range of –40 °C to at least +60 °C, types KV Ex from –20 °C to +40 °C.

The upper temp. threshold value varies between the models and can be found at the related charts on the individual product page.

The models and their specifications

KV

Centrifugal rectangular fans with forward curved impeller paddles and swing-out motor impeller unit. Low-noise centrifugal impellers in volute casing for high pressure levels.

$V = 920 - 8500 \text{ m}^3/\text{h}$.

Compact and flat design for versatile usage in exhaust and fresh air systems in commercial and industrial applications.



KR and KR EC

Rectangular fans with backward curved impeller paddles, with optional energy-saving EC motor technology. High performance centrifugal impellers with high efficiency. Swing-out motor impeller unit.

$V = 540 - 14410 \text{ m}^3/\text{h}$.

For conveying higher volume flow rates in extract and fresh air systems.

Uncritical in extraction of polluted air.



SKR and SKR EC

High performance centrifugal impellers (backward curved) in sound insulated casing with good damping characteristics for noise-critical applications, with optional energy-saving EC motor technology. Performance figures similar to KR.

$V = 1770 - 13700 \text{ m}^3/\text{h}$.

For further reduction of intake and exhaust air noise levels, rectangular attenuators (KLF, accessory) are recommended. Exhaust and fresh air fans for applications with specific noise level requirements.

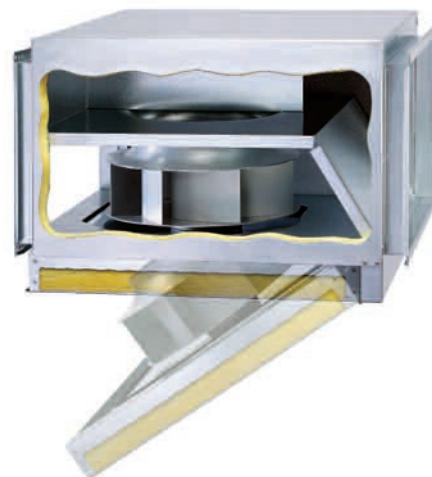

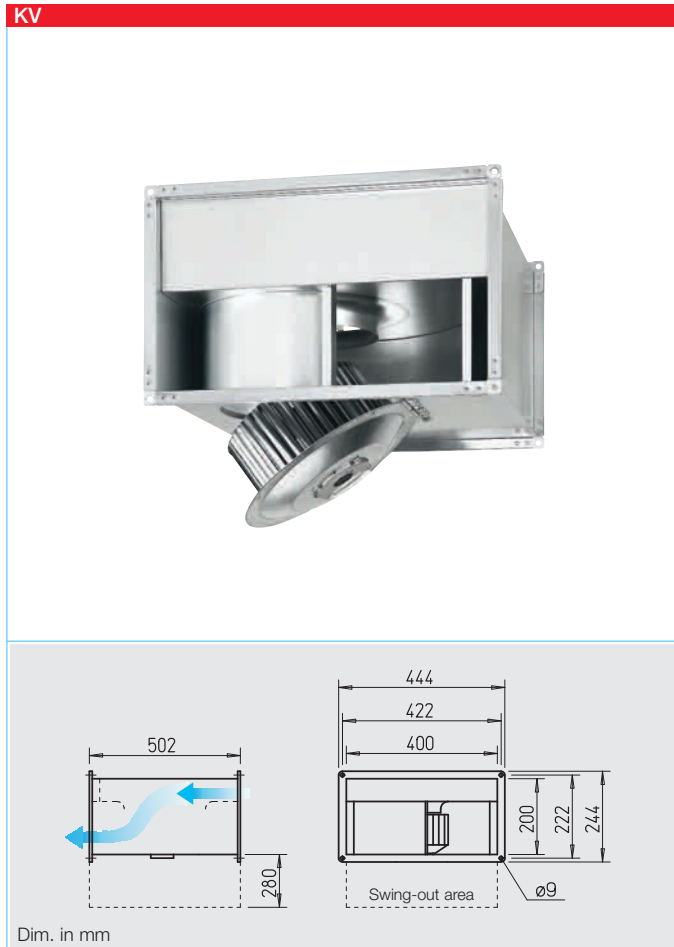

Rectangular centrifugal fan with forward curved impeller blades and swing-out motor impeller unit.

- Low-noise centrifugal impellers in aerodynamic galvanised steel casing for high pressure levels.
- Compact and flat design for use in extract and fresh air systems in commercial and industrial applications.

■ **Specification**

□ **Casing**

Made of galvanised steel and flanged on both ends. Space saving, compact design.

- Easy to clean and service thanks to the swing-out motor impeller unit.

□ **Impeller**

Forward curved centrifugal impeller made of galvanised steel, highly efficient with low noise levels. Aerodynamically optimised casing; intake air flow by means of an inlet nozzle.

□ **Motor**

Totally enclosed, maintenance-free external rotor motor with directly fitted impeller, protected to IP 44. Windings with protection against moisture. Ball bearing mounted and interference-free. Dynamically balanced with

resilient motor mounting bracket for low vibration and low noise operation.

□ **Electrical connection**

Terminal box (IP 55 for 3 ph.- or IP 44 for 1 ph.-types) is mounted with a permanently attached cable.

□ **Motor protection**

Model KVV through thermal contacts which are connected in series with winding and automatically resets. Model KVD through built-in thermal contacts which must be connected to a motor full protection device.

□ **Speed control**

By voltage reduction using a 5 speed transformer controller (recommended) or an electronic controller (stepless). The performance figures at corresponding voltages are given in the performance curve.

□ **Sound Levels**

Above the performance curve, total values and spectrum are given for:

- Sound level case breakout
 - Sound level intake
 - Sound level exhaust
- The sound power level (on intake) is additionally shown within the performance curve for corresponding control voltages. In the table below you can also find:
- Case breakout sound level at 4 m (free field conditions).

□ **Installation**

Possible in any position. Attention should be paid to accessibility/swing out.

Note	Page
Selection chart	372
Technical description	373
Design guidelines	10 on
Modul. system components	370

Type	Ref. no.	Air flow volume, free discharge V m³/h	Nominal R.P.M. min⁻¹	Sound press. case breakout dB(A) in 4 m	Power consumption		Wiring diagram No.	Max. air flow temperature at Nom. vol. Control		Weight net approx. kg	Speed controller 5-step				Motor full protection device to connect built-in thermal contacts	
					kW	A		+°C	+°C		Type	Ref. no.	Type	Ref. no.	Type	Ref. no.
1-phase motor, 230 V, 50 Hz, capacitor motor, protection to IP 44																
KVV 200/4/40/20	5675	925	810	37	0.21	0,95	508	60	50	11	TSW 1,5	1495	—	—	—	—
3-phase motor, 230/400 V, 50 Hz, protected to IP 44																
KVD 200/4/40/20	5676	1130	1260	36	0.25	0,82/0,47	860	70	70	8,6	TSD 0,8	1500	RDS 1	1314	MD	5849

KVV 200/4/40/20

Frequency	Hz	Total	125	250	500	1k	2k	4k	8k
L _{WA} Case breakout		dB(A) 57	46	52	50	52	45	40	32
L _{WA} Intake		dB(A) 69	64	64	61	55	56	54	47
L _{WA} Exhaust		dB(A) 72	63	65	65	64	63	62	55

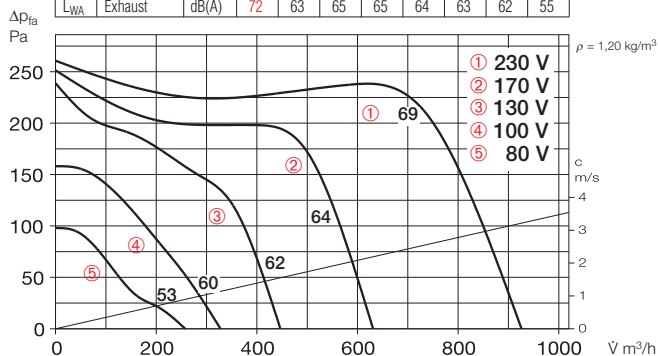

KVD 200/4/40/20

Frequency	Hz	Total	125	250	500	1k	2k	4k	8k
L _{WA} Case breakout		dB(A) 56	45	52	51	48	45	43	37
L _{WA} Intake		dB(A) 70	65	65	62	58	58	59	54
L _{WA} Exhaust		dB(A) 77	68	70	68	68	70	68	64

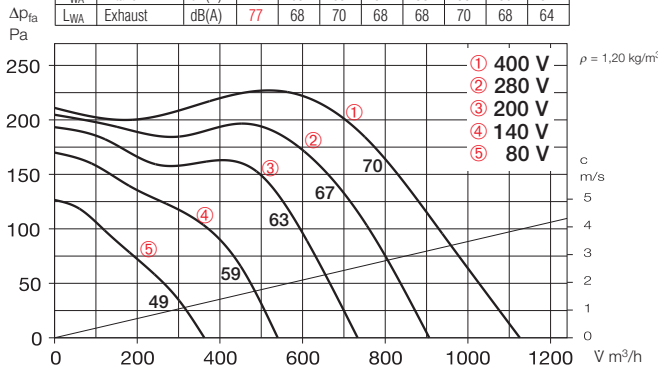

Accessory details Page

Shutters, grilles and louvres	420, 487
Filters, heaters and attenuators	421
Temperature control systems for heaters	427, 432
Speed controllers and motor full protection devices	525

Accessories

Gravity shutter

Type VK 40/20 Ref. no. 0874

External airflow operated gravity shutter made of polymer, light grey.



External louvres

Type WSG 40/20 Ref. no. 0109

Robust construction made of aluminium extrusion profile, natural colour anodised.



Volume control damper for ducting

Type JVK 40/20 Ref. no. 6910

Casing made with flanges on both sides. The control mechanism is outside the airstream. For electrical drive, see STM, accessory.



Circular spigot

Type FSK 40/20 Ref. no. 0832

For cost effective adaption of rectangular fans into circular ducting systems with \varnothing 200 mm.



Flexible connectors

Type VS 40/20 Ref. no. 5694

Flexible in-duct connector with flanges on both sides.



Counterflange

Type GF 40/20 Ref. no. 6919

Flange frames made of galvanised steel for connection to ducting.



Rectangular attenuator

Type KSD 40/20 Ref. no. 8728

For in-duct installation on intake or exhaust side.



Air-duct filter

Type KLF 40/20 G4 No. 8720

Type KLF 40/20 F7 No. 8644

Bag filter with a large cross section area. Galvanised steel casing with flanges on both sides.



Electric heater battery

Type EHR-K 6/40/20 No. 8702

Type EHR-K 15/40/20 No. 8703

Heating elements enclosed in a galvanised steel casing with connecting flanges on both sides.



Temperature control system for electric heater battery

Type EHSD 16 Ref. no. 5003



Warm water heater battery

Type WHR 2/40/20 No. 8782

Type WHR 4/40/20 No. 8783

For in-duct installation.

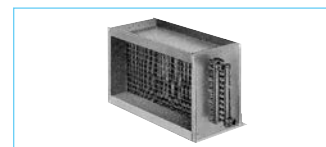

Temperature control system for warm water heater battery

Type WHS HE Ref. no. 8319



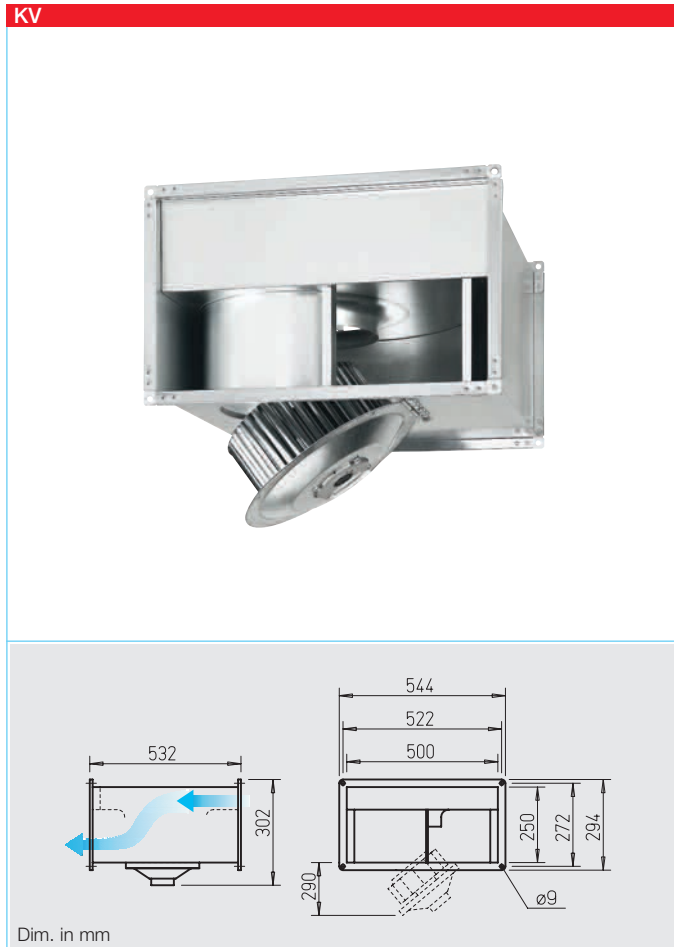

Rectangular centrifugal fan with forward curved impeller blades and swing-out motor impeller unit.

- Low-noise centrifugal impellers in aerodynamic galvanised steel casing for high pressure levels.
- Compact and flat design for use in extract and fresh air systems in commercial and industrial applications.

■ **Specification**

□ **Casing**

Made of galvanised steel and flanged on both ends. Space saving, compact design.

- Easy to clean and service thanks to the swing-out motor impeller unit.

□ **Impeller**

Forward curved centrifugal impeller made of galvanised steel, highly efficient with low noise levels. Aerodynamically optimised casing; intake air flow by means of an inlet nozzle.

□ **Motor**

Totally enclosed, maintenance-free external rotor motor with directly fitted impeller, protected to IP 44. Windings with protection against moisture. Ball bearing mounted and interference-free.

Dynamically balanced with resilient motor mounting bracket for low vibration and low noise operation.

□ **Electrical connection**

Terminal box (IP 55 for 3 ph., IP 65 for explosion-proof types) is mounted with permanently attached cable.

□ **Motor protection**

Through built-in thermal contacts which must be connected to a motor full protection device.

□ **Speed control**

By voltage reduction using a 5 speed transformer controller (recommended) or an electronic controller (stepless). The performance figures at corresponding voltages are given in the performance curve.

□ **Sound Levels**

Above the performance curve, total values and spectrum are given for:

- Sound level case breakout
 - Sound level intake
 - Sound level exhaust
- The sound power level (on intake) is additionally shown within the performance curve for corresponding control voltages. In the table below you can also find:
- Case breakout sound level at 4 m (free field conditions).

□ **Installation**

Possible in any position. Attention should be paid to accessibility/swing out.

Note	Page
Selection chart	372
Technical description	373
Design guidelines	10 on
Modul. system components	370

□ **Explosion-proof models**

Thermal motor protection through built-in PTC (positive temperature coefficient) thermistors which must be connected to a tripping unit MSA. Using this motor protection enables the speed control where a minimum voltage of 100 V must be maintained.

Type	Ref. no.	Air flow volume, free discharge	Nominal R.P.M.	Sound press. case breakout	Power consumption		Wiring diagram	Max. air flow temperature at		Weight net approx.	Speed controller 5-step				Motor full protection device to connect built-in thermal contacts	
					kW	A		Nom. vol.	Control		kg	Type	Ref. no.	Type	Ref. no.	Type
3 ph. motor, 230/400 V, 50 Hz, protection to IP 44																
KVD 225/4/50/25	5679	1950	1270	43	0.54	1.6/0.93	860	65	60	17	TSD 1,5	1501	RDS 2	1315	MD	5849
Explosion-proof Ex e II, temperature class T1 – T3, 3-phase 400 V, 50 Hz, protection to IP 44																
KVD 225/4/50/25 Ex	6810	1900	1280	43	0.53	0.92	899	40	40	17	TSD 1,5	1501	—	—	MSA	1289

KVD 225/4/50/25

Frequency	Hz	Total	125	250	500	1k	2k	4k	8k	
L _{WA} Case breakout		dB(A)	63	47	56	56	57	55	51	44
L _{WA} Intake		dB(A)	72	64	66	62	63	65	64	58
L _{WA} Exhaust		dB(A)	78	63	66	69	73	72	71	65

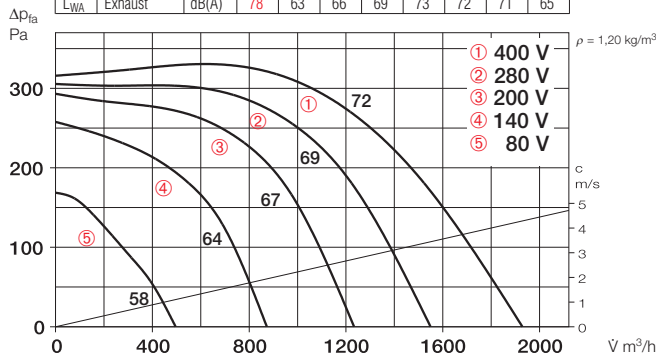

KVD 225/4/50/25 Ex

Frequency	Hz	Total	125	250	500	1k	2k	4k	8k	
L _{WA} Case breakout		dB(A)	63	43	56	57	58	54	49	43
L _{WA} Intake		dB(A)	73	65	66	62	63	65	65	60
L _{WA} Exhaust		dB(A)	79	63	67	70	73	73	72	67

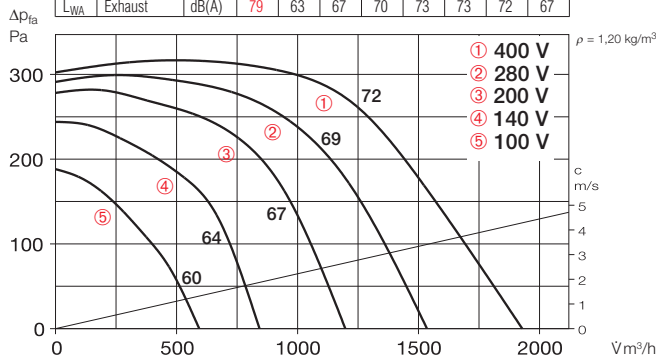

Accessory details Page

Shutters, grilles and louvres	420, 487	on
Filters, heaters and attenuators	421	on
Temperature control systems for heaters	427, 432	on
Speed controllers and motor full protection devices	525	on

Accessories

Gravity shutter

Type VK 50/25 Ref. no. 0875
External airflow operated gravity shutter made of polymer, light grey.



External louvres

Type WSG 50/25 Ref. no. 0110
Robust construction made of aluminium extrusion profile, natural colour anodised.



Volume control damper for ducting

Type JVK 50/25 Ref. no. 6911
Casing made with flanges on both sides. The control mechanism is outside the airstream. For electrical drive, see STM, accessory.



Circular spigot

Type FSK 50/25 Ref. no. 0833
For cost effective adaption of rectangular fans into circular ducting systems with Ø 250 mm.



Flexible connectors

Type VS 50/25 Ref. no. 5695
Flexible in-duct connector with flanges on both sides.

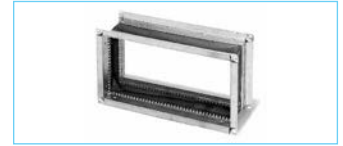

– for Ex-fans

Type VS 50/25 Ex Ref. no. 0265



Counterflange

Type GF 50/25 Ref. no. 6920
Flange frames made of galvanised steel for connection to ducting.



Rectangular attenuator

Type KSD 50/25-30 No. 8729
For in-duct installation on intake or exhaust side.



Air-duct filter

Type KLF 50/25-30 G4 No. 8721
Type KLF 50/25-30 F7 No. 8645
Bag filter with a large cross section area. Galvanised steel casing with flanges on both sides.



Electric heater battery

Type EHR-K 8/50/25-30 No. 8704
Type EHR-K 24/50/25-30 No. 8705
Heating elements enclosed in a galvanised steel casing with connecting flanges on both sides.



Temperature control system for electric heater battery

Type EHSD 16 Ref. no. 5003

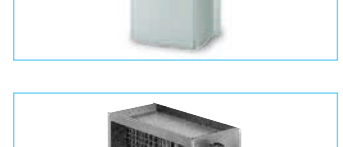

Warm water heater battery

Type WHR 2/50/25-30 No. 8784
Type WHR 4/50/25-30 No. 8785
For in-duct installation.

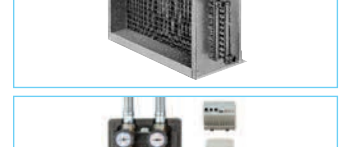

Temperature control system for warm water heater battery

Type WHS HE Ref. no. 8319



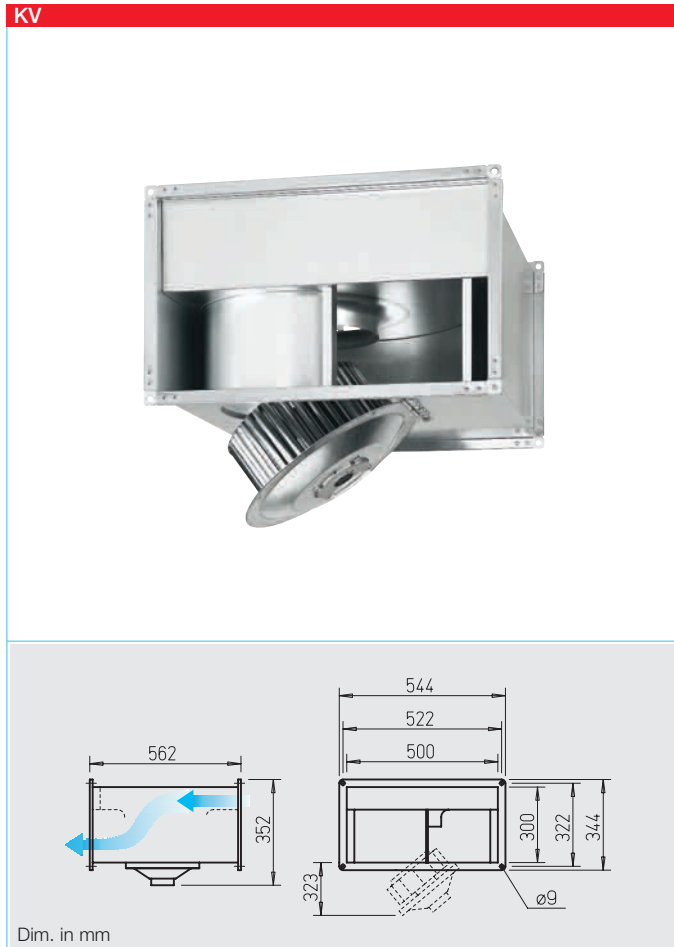

Rectangular centrifugal fan with forward curved impeller blades and swing-out motor impeller unit.

- Low-noise centrifugal impellers in aerodynamic galvanised steel casing for high pressure levels.
- Compact and flat design for use in extract and fresh air systems in commercial and industrial applications.

■ **Specification**

□ **Casing**

Made of galvanised steel and flanged on both ends. Space saving, compact design.

- Easy to clean and service thanks to the swing-out motor impeller unit.

□ **Impeller**

Forward curved centrifugal impeller made of galvanised steel, highly efficient with low noise levels. Aerodynamically optimised casing; intake air flow by means of an inlet nozzle.

□ **Motor**

Totally enclosed, maintenance-free external rotor motor with directly fitted impeller, protected to IP 44. Windings with protection against moisture. Ball bearing mounted and interference-free.

Dynamically balanced with resilient motor mounting bracket for low vibration and low noise operation.

□ **Electrical connection**

Terminal box (IP 55 for 3 ph., IP 65 for explosion-proof types) is mounted with permanently attached cable.

□ **Motor protection**

Through built-in thermal contacts which must be connected to a motor full protection device.

□ **Speed control**

By voltage reduction using a 5 speed transformer controller (recommended) or an electronic controller (stepless). The performance figures at corresponding voltages are given in the performance curve.

□ **Sound Levels**

Above the performance curve, total values and spectrum are given for:

- Sound level case breakout
 - Sound level intake
 - Sound level exhaust
- The sound power level (on intake) is additionally shown within the performance curve for corresponding control voltages. In the table below you can also find:
- Case breakout sound level at 4 m (free field conditions).

□ **Installation**

Possible in any position. Attention should be paid to accessibility/swing out.

Note	Page
Selection chart	372
Technical description	373
Design guidelines	10 on
Modul. system components	370

Type	Ref. no.	Air flow volume, free discharge	Nominal R.P.M.	Sound press. case breakout	Power consumption		Wiring diagram	Max. air flow temperature at		Weight net approx.	Speed controller 5-step				Motor full protection device to connect built-in thermal contacts	
					Control	Control		without motor protect. unit	with motor protect. unit		Type	Ref. no.	Type	Ref. no.	Type	Ref. no.
3-phase motor, 230/400 V, 50 Hz, protected to IP 44																
KVD 250/4/50/30	5682	2200	1260	42	0.72	2.5/1.5	860	60	60	21	TSD 1,5	1501	RDS 2	1315	MD	5849
Explosion-proof Ex e II, temperature class T1 – T3, 3-phase 400 V, 50 Hz, protection to IP 44																
KVD 250/4/50/30 Ex	6811	2300	1240	42	0.74	1.5	899	40	40	21	TSD 1,5	1501	—	—	MSA	1289

KVD 250/4/50/30

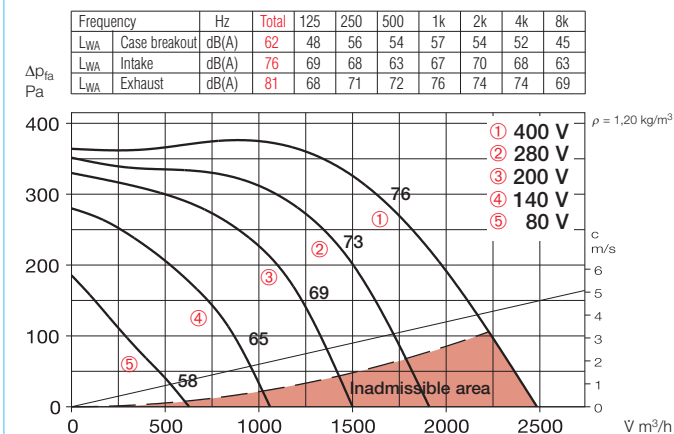

KVD 250/4/50/30 Ex

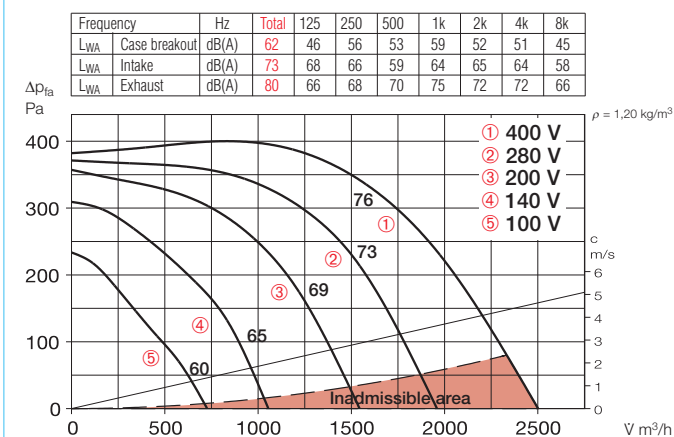

Accessory details Page

Shutters, grilles and louvres	420, 487 on
Filters, heaters and attenuators	421 on
Temperature control systems for heaters	427, 432 on
Speed controllers and motor full protection devices	525 on

Accessories

Gravity shutter

Type VK 50/30 Ref. no. 0876

External airflow operated gravity shutter made of polymer, light grey.



External louvres

Type WSG 50/30 Ref. no. 0111

Robust construction made of aluminium extrusion profile, natural colour anodised.



Volume control damper for ducting

Type JVK 50/30 Ref. no. 6912

Casing made with flanges on both sides. The control mechanism is outside the airstream. For electrical drive, see STM, accessory.



Circular spigot

Type FSK 50/30 Ref. no. 0837

For cost effective adaption of rectangular fans into circular ducting systems with $\varnothing 315 \text{ mm}$.



Flexible connectors

Type VS 50/30 Ref. no. 5696

Flexible in-duct connector with flanges on both sides.



– for Ex-fans

Type VS 50/30 Ex Ref. no. 0266



Counterflange

Type GF 50/30 Ref. no. 6921

Flange frames made of galvanised steel for connection to ducting.



Rectangular attenuator

Type KSD 50/25-30 No. 8729

For in-duct installation on intake or exhaust side.



Air-duct filter

Type KLF 50/25-30 G4 No. 8721

Type KLF 50/25-30 F7 No. 8645

Bag filter with a large cross section area. Galvanised steel casing with flanges on both sides.



Electric heater battery

Type EHR-K 8/50/25-30 No. 8704

Type EHR-K 24/50/25-30 No. 8705

Heating elements enclosed in a galvanised steel casing with connecting flanges on both sides.



Temperature control system for electric heater battery

Type EHSD 16 Ref. no. 5003

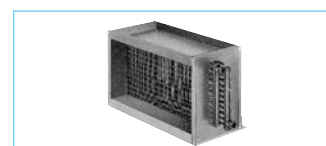

Warm water heater battery

Type WHR 2/50/25-30 No. 8784

Type WHR 4/50/25-30 No. 8785

For in-duct installation.



Temperature control system for warm water heater battery

Type WHS HE Ref. no. 8319

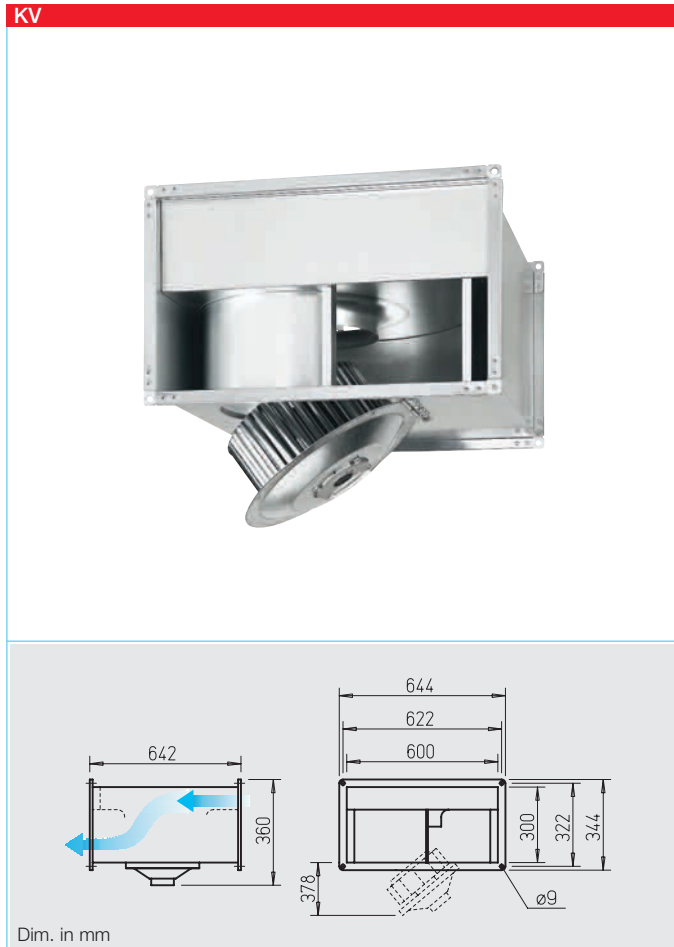

Rectangular centrifugal fan with forward curved impeller blades and swing-out motor impeller unit.

- Low-noise centrifugal impellers in aerodynamic galvanised steel casing for high pressure levels.
- Compact and flat design for use in extract and fresh air systems in commercial and industrial applications.

■ **Specification**

□ **Casing**

Made of galvanised steel and flanged on both ends. Space saving, compact design.

- Easy to clean and service thanks to the swing-out motor impeller unit.

□ **Impeller**

Forward curved centrifugal impeller made of galvanised steel, highly efficient with low noise levels. Aerodynamically optimised casing; intake air flow by means of an inlet nozzle.

□ **Motor**

Totally enclosed, maintenance-free external rotor motor with directly fitted impeller, protected to IP 44. Windings with protection against moisture. Ball bearing mounted and interference-free.

Dynamically balanced with resilient motor mounting bracket for low vibration and low noise operation.

□ **Electrical connection**

Terminal box (IP 55 for 3 ph., IP 65 for explosion-proof types) is mounted with permanently attached cable.

□ **Motor protection**

Through built-in thermal contacts which must be connected to a motor full protection device.

□ **Speed control**

By voltage reduction using a 5 speed transformer controller (recommended) or an electronic controller (stepless). The performance figures at corresponding voltages are given in the performance curve.

□ **Sound Levels**

Above the performance curve, total values and spectrum are given for:

- Sound level case breakout
 - Sound level intake
 - Sound level exhaust
- The sound power level (on intake) is additionally shown within the performance curve for corresponding control voltages. In the table below you can also find:
- Case breakout sound level at 4 m (free field conditions).

□ **Installation**

Possible in any position. Attention should be paid to accessibility/swing out.

Note	Page
Selection chart	372
Technical description	373
Design guidelines	10 on
Modul. system components	370

□ **Explosion-proof models**

Thermal motor protection through built-in PTC (positive temperature coefficient) thermistors which must be connected to a tripping unit MSA. Using this motor protection enables the speed control where a minimum voltage of 100 V must be maintained.

Type	Ref. no.	Air flow volume, free discharge	Nominal R.P.M.	Sound press. case breakout	Power consumption		Wiring diagram	Max. air flow temperature at		Weight net approx.	Speed controller 5-step				Motor full protection device to connect built-in thermal contacts	
					kW	A		Nom. vol.	Control		kg	Type	Ref. no.	Type	Ref. no.	Type
3-phase motor, 230/400 V, 50 Hz, protected to IP 44																
KVD 280/4/60/30	5684	3950	1300	45	1.67	5.4/3.1	860	65	60	35	TSD 5,5	1503	RDS 7	1578	MD	5849
Explosion-proof Ex e II, temperature class T1 – T3, 3-phase 230/400 V, 50 Hz, protection to IP 44																
KVD 280/4/60/30 Ex	6812	3450	1340	47	1.45	2.9	899	40	40	34	TSD 5,5	1503	—	—	MSA	1289

KVD 280/4/60/30

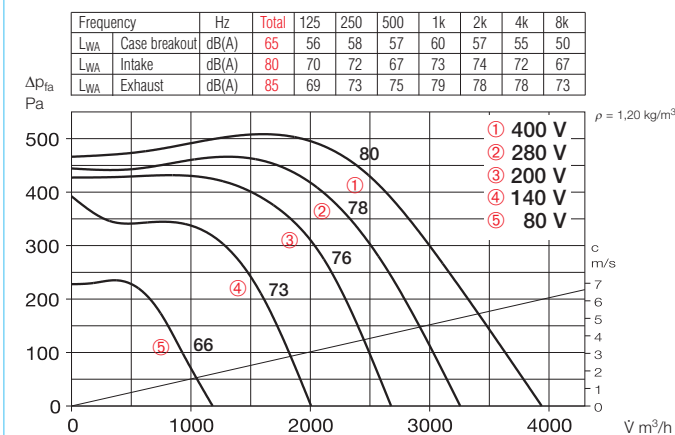

KVD 280/4/60/30 Ex

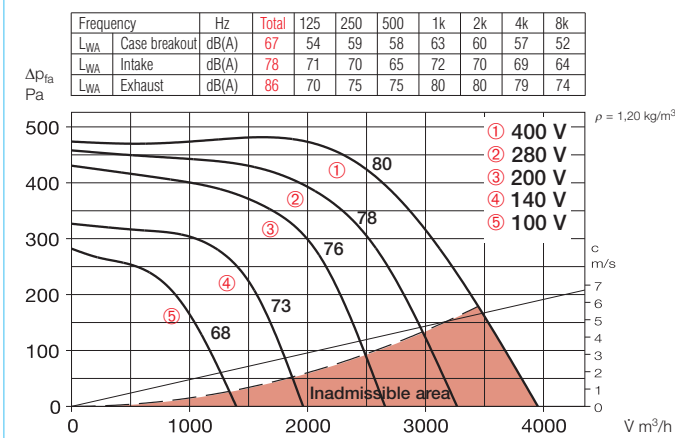

Accessory details Page

Shutters, grilles and louvres	420, 487
Filters, heaters and attenuators	421
Temperature control systems for heaters	427, 432
Speed controllers and motor full protection devices	525

Accessories

Gravity shutter

Type VK 60/30 Ref. no. 0877

External airflow operated gravity shutter made of polymer, light grey.



External louvres

Type WSG 60/30 Ref. no. 0112

Robust construction made of aluminium extrusion profile, natural colour anodised.



Volume control damper for ducting

Type JVK 60/30 Ref. no. 6913

Casing made with flanges on both sides. The control mechanism is outside the airstream. For electrical drive, see STM, accessory.



Circular spigot

Type FSK 60/30 Ref. no. 0834

For cost effective adaption of rectangular fans into circular ducting systems with Ø 315 mm.



Flexible connectors

Type VS 60/30 Ref. no. 5697

Flexible in-duct connector with flanges on both sides.



– for Ex-fans

Type VS 60/30 Ex Ref. no. 0267



Counterflange

Type GF 60/30 Ref. no. 6922

Flange frames made of galvanised steel for connection to ducting.



Rectangular attenuator

Type KSD 60/30-35 No. 8730

For in-duct installation on intake or exhaust side.



Air-duct filter

Type KLF 60/30-35 G4 No. 8722

Type KLF 60/30-35 F7 No. 8646

Bag filter with a large cross section area. Galvanised steel casing with flanges on both sides.



Electric heater battery

Type EHR-K 15/60/30-35 No. 8706

Type EHR-K 30/60/30-35 No. 8707

Heating elements enclosed in a galvanised steel casing with connecting flanges on both sides.



Temperature control system for electric heater battery

Type EHSD 16 Ref. no. 5003



Warm water heater battery

Type WHR 2/60/30-35 No. 8786

Type WHR 4/60/30-35 No. 8787

For in-duct installation.

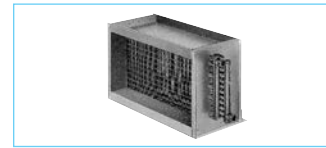

Temperature control system for warm water heater battery

Type WHS HE¹⁾ Ref. no. 8319

¹⁾ In model WHR 4/60/30-35 the heat output is reduced to 2200 l/h.



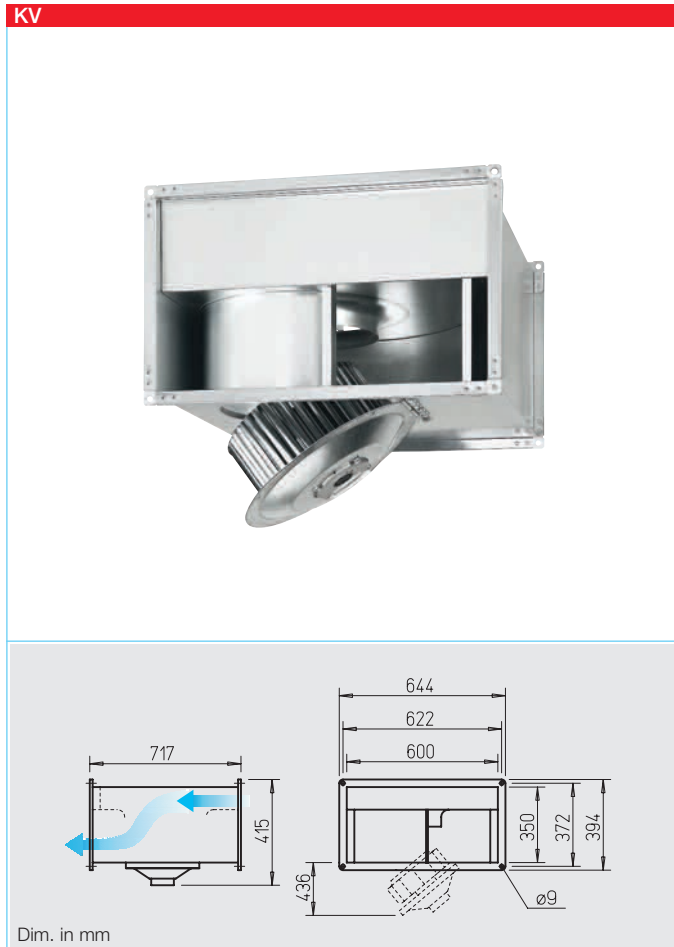

Rectangular centrifugal fan with forward curved impeller blades and swing-out motor impeller unit.

- Low-noise centrifugal impellers in aerodynamic galvanised steel casing for high pressure levels.
- Compact and flat design for use in extract and fresh air systems in commercial and industrial applications.

■ **Specification**

□ **Casing**

Made of galvanised steel and flanged on both ends. Space saving, compact design.

- Easy to clean and service thanks to the swing-out motor impeller unit.

□ **Impeller**

Forward curved centrifugal impeller made of galvanised steel, highly efficient with low noise levels. Aerodynamically optimised casing; intake air flow by means of an inlet nozzle.

□ **Motor**

Totally enclosed, maintenance-free external rotor motor with directly fitted impeller, protected to IP 44. Windings with protection against moisture. Ball bearing mounted and interference-free.

Dynamically balanced with resilient motor mounting bracket for low vibration and low noise operation.

□ **Electrical connection**

Terminal box (IP 55 for 3 ph., IP 65 for explosion-proof types) is mounted with permanently attached cable.

□ **Motor protection**

Through built-in thermal contacts which must be connected to a motor full protection device.

□ **Speed control**

By voltage reduction using a 5 speed transformer controller (recommended) or an electronic controller (stepless). The performance figures at corresponding voltages are given in the performance curve.

□ **Sound Levels**

Above the performance curve, total values and spectrum are given for:

- Sound level case breakout
 - Sound level intake
 - Sound level exhaust
- The sound power level (on intake) is additionally shown within the performance curve for corresponding control voltages. In the table below you can also find:
- Case breakout sound level at 4 m (free field conditions).

□ **Installation**

Possible in any position. Attention should be paid to accessibility/swing out.

Note	Page
Selection chart	372
Technical description	373
Design guidelines	10 on
Modul. system components	370

□ **Explosion-proof models**

Thermal motor protection through built-in PTC (positive temperature coefficient) thermistors which must be connected to a tripping unit MSA. Using this motor protection enables the speed control where a minimum voltage of 100 V must be maintained.

Type	Ref. no.	Air flow volume, free discharge V m³/h	Nominal R.P.M. min⁻¹	Sound press. case breakout dB(A) in 4 m	Power consumption		Wiring diagram No.	Max. air flow temperature at Nom. vol. Control		Weight net approx. kg	Speed controller 5-step				Motor full protection device to connect built-in thermal contacts	
					kW	A		+°C	+°C		Type	Ref. no.	Type	Ref. no.	Type	Ref. no.
3-phase motor, 230/400 V, 50 Hz, protected to IP 44																
KVD 315/4/60/35	5686	4500	1350	48	2.06	6.8/3.9	860	60	55	42	TSD 5,5	1503	RDS 7	1578	MD	5849
Explosion-proof Ex e II, temperature class T1 – T3, 3-phase 230/400 V, 50 Hz, protection to IP 44																
KVD 315/4/60/35 Ex	6813	4200	1370	48	2.0	4.0	899	40	40	42	TSD 5,5	1503	—	—	MSA	1289

KVD 315/4/60/35

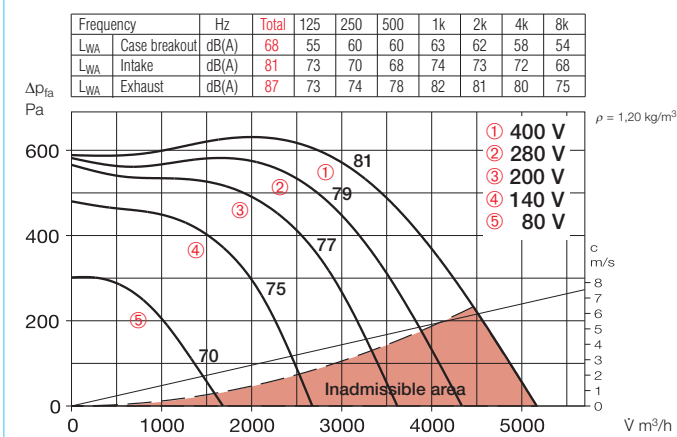

KVD 315/4/60/35 Ex

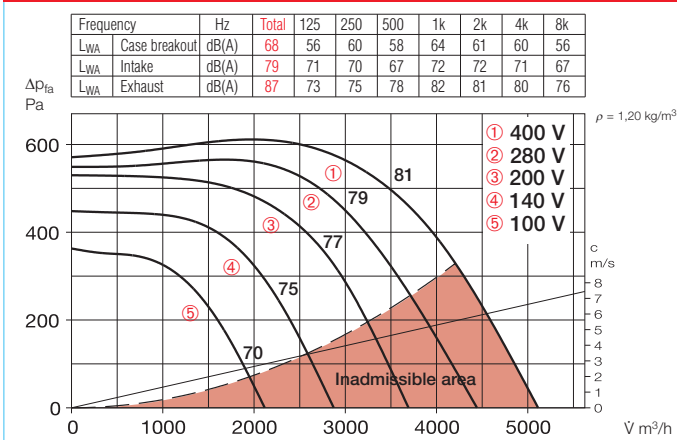

Accessory details Page

Shutters, grilles and louvres	420, 487
Filters, heaters and attenuators	421
Temperature control systems for heaters	427, 432
Speed controllers and motor full protection devices	525

Accessories

Gravity shutter

Type VK 60/35 Ref. no. 0878

External airflow operated gravity shutter made of polymer, light grey.



External louvres

Type WSG 60/35 Ref. no. 0113

Robust construction made of aluminium extrusion profile, natural colour anodised.



Volume control damper for ducting

Type JVK 60/35 Ref. no. 6914

Casing made with flanges on both sides. The control mechanism is outside the airstream. For electrical drive, see STM, accessory.



Circular spigot

Type FSK 60/35 Ref. no. 0835

For cost effective adaption of rectangular fans into circular ducting systems with Ø 355 mm.



Flexible connectors

Type VS 60/35 Ref. no. 5698

Flexible in-duct connector with flanges on both sides.



– for Ex-fans

Type VS 60/35 Ex Ref. no. 0268



Counterflange

Type GF 60/35 Ref. no. 6923

Flange frames made of galvanised steel for connection to ducting.



Rectangular attenuator

Type KSD 60/30-35 No. 8730

For in-duct installation on intake or exhaust side.



Air-duct filter

Type KLF 60/30-35 G4 No. 8722

Type KLF 60/30-35 F7 No. 8646

Bag filter with a large cross section area. Galvanised steel casing with flanges on both sides.



Electric heater battery

Type EHR-K 15/60/30-35 No. 8706

Type EHR-K 30/60/30-35 No. 8707

Heating elements enclosed in a galvanised steel casing with connecting flanges on both sides.



Temperature control system for electric heater battery

Type EHSD 16 Ref. no. 5003



Warm water heater battery

Type WHR 2/60/30-35 No. 8786

Type WHR 4/60/30-35 No. 8787

For in-duct installation.

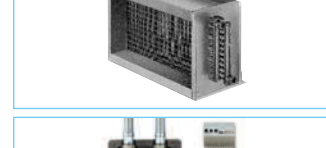

Temperature control system for warm water heater battery

Type WHS HE¹⁾ Ref. no. 8319

¹⁾ In model WHR 4/60/30-35 the heat output is reduced to 2200 l/h.



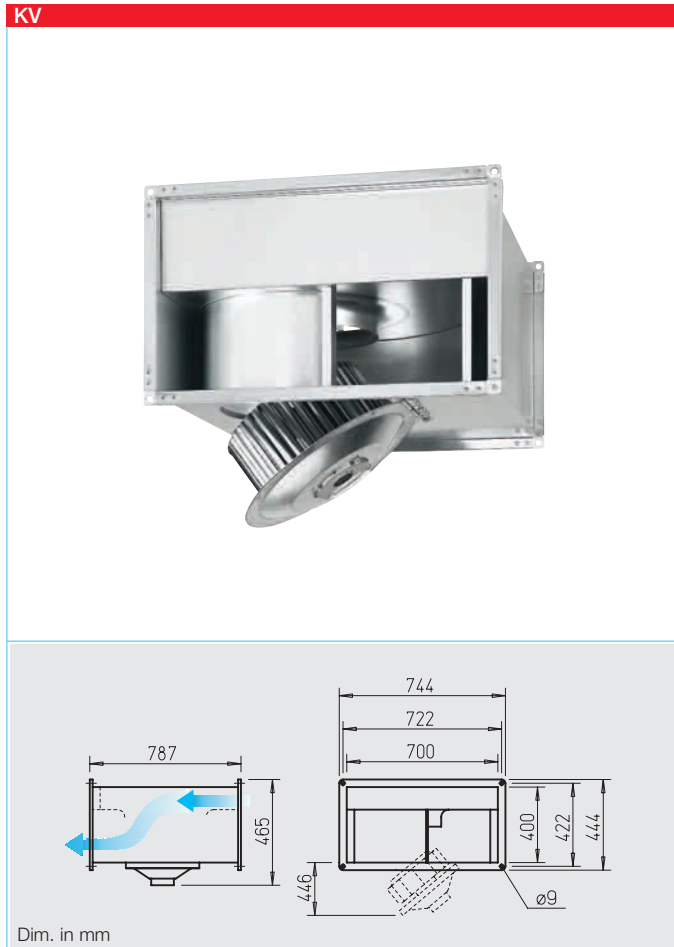

Rectangular centrifugal fan with forward curved impeller blades and swing-out motor impeller unit.

- Low-noise centrifugal impellers in aerodynamic galvanised steel casing for high pressure levels.
- Compact and flat design for use in extract and fresh air systems in commercial and industrial applications.

■ **Specification**

□ **Casing**

Made of galvanised steel and flanged on both ends. Space saving, compact design.

- Easy to clean and service thanks to the swing-out motor impeller unit.

□ **Impeller**

Forward curved centrifugal impeller made of galvanised steel, highly efficient with low noise levels. Aerodynamically optimised casing; intake air flow by means of an inlet nozzle.

□ **Motor**

Totally enclosed, maintenance-free external rotor motor with directly fitted impeller, protected to IP 44. Windings with protection against moisture. Ball bearing mounted

and interference-free. Dynamically balanced with resilient motor mounting bracket for low vibration and low noise operation.

□ **Electrical connection**

Terminal box (IP 55 for 3 ph., IP 65 for explosion-proof types) is mounted with permanently attached cable.

□ **Motor protection**

Through built-in thermal contacts which must be connected to a motor full protection device.

□ **Speed control**

By voltage reduction using a 5 speed transformer controller (recommended) or an electronic controller (stepless). The performance figures at corresponding voltages are given in the performance curve.

□ **Sound Levels**

Above the performance curve, total values and spectrum are given for:

- Sound level case breakout
 - Sound level intake
 - Sound level exhaust
- The sound power level (on intake) is additionally shown within the performance curve for corresponding control voltages. In the table below you can also find:
- Case breakout sound level at 4 m (free field conditions).

□ **Installation**

Possible in any position. Attention should be paid to accessibility/swing out.

Note	Page
Selection chart	372
Technical description	373
Design guidelines	10 on
Modul. system components	370

Type	Ref. no.	Air flow volume, free discharge	Nominal R.P.M.	Sound press. case breakout	Power consumption		Wiring diagram	Max. air flow temperature at		Weight net approx.	Speed controller 5-step				Motor full protection device to connect built-in thermal contacts	
					V m³/h	min ⁻¹		dB(A) in 4 m	kW		A	Nom. vol.	Control	kg	Type	Ref. no.
3-phase motor, 230/400 V, 50 Hz, protected to IP 44																
KVD 355/8/70/40	5687	4850	680	35	1.02	3.9/2.3	860	70	70	49	TSD 5,5	1503	RDS 4	1316	MD	5849
KVD 355/6/70/40	5688	5000	830	42	1.53	5.5/3.2	860	60	60	54	TSD 5,5	1503	RDS 4	1316	MD	5849
KVD 355/4/70/40	5689	5800	1400	54	3.48	10.4/6.0	860	70	50	60	TSD 11	1513	RDS 11	1332	MD	5849
Explosion-proof Ex e II, temperature class T1 – T3, 3-phase 230/400 V, 50 Hz, protection to IP 44																
KVD 355/6/70/40 Ex	6814	4800	800	48	1.40	2.4	899	40	40	49	TSD 3,0	1502	—	—	MSA	1289

KVD 355/8/70/40

Frequency	Hz	Total	125	250	500	1k	2k	4k	8k
L _{WA} Case breakout		dB(A) 55	46	50	50	48	45	40	32
L _{WA} Intake		dB(A) 67	58	59	57	62	60	57	48
L _{WA} Exhaust		dB(A) 77	64	69	69	69	69	68	61

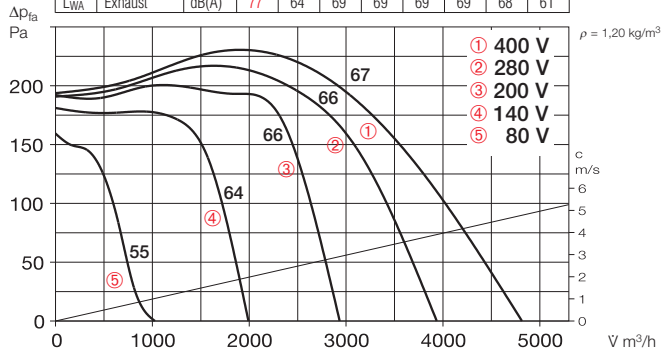

KVD 355/6/70/40

Frequency	Hz	Total	125	250	500	1k	2k	4k	8k
L _{WA} Case breakout		dB(A) 62	52	52	55	56	53	51	46
L _{WA} Intake		dB(A) 73	65	64	61	67	65	64	58
L _{WA} Exhaust		dB(A) 81	69	72	73	74	74	73	67

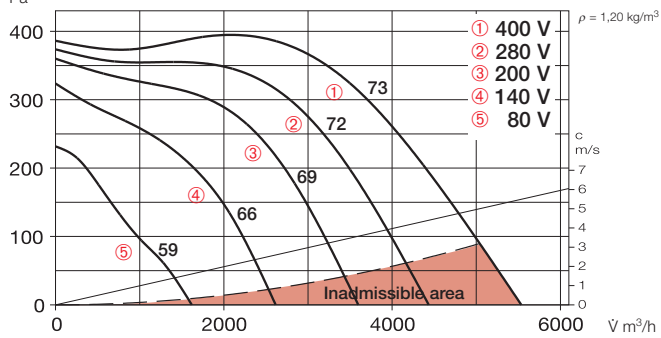

KVD 355/4/70/40

Frequency	Hz	Total	125	250	500	1k	2k	4k	8k
L _{WA} Case breakout		dB(A) 74	63	66	67	68	67	65	59
L _{WA} Intake		dB(A) 87	76	76	72	83	81	79	75
L _{WA} Exhaust		dB(A) 90	76	79	78	84	84	83	78

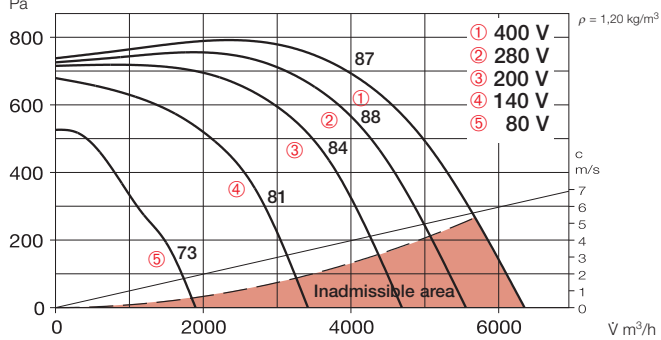

KVD 355/6/70/40 Ex

Frequency	Hz	Total	125	250	500	1k	2k	4k	8k
L _{WA} Case breakout		dB(A) 68	51	56	57	62	64	61	52
L _{WA} Intake		dB(A) 75	65	65	63	68	68	66	60
L _{WA} Exhaust		dB(A) 79	66	69	70	73	72	72	65

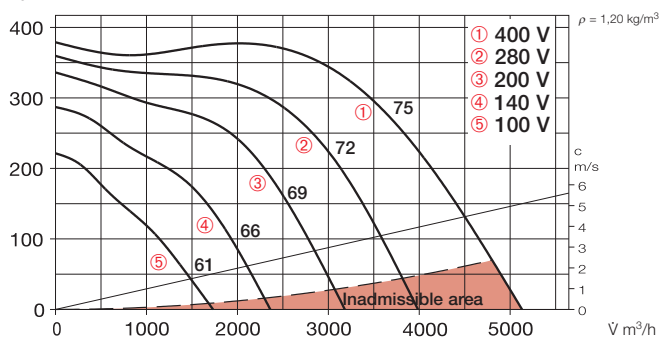

Accessories

Gravity shutter

Type VK 70/40 Ref. no. 0879
External airflow operated gravity shutter made of polymer, light grey.



External louvres

Type WSG 70/40 Ref. no. 0114
Robust construction made of aluminium extrusion profile, natural colour anodised.



Volume control damper for ducting

Type JVK 70/40 Ref. no. 6915
Casing made with flanges on both sides. The control mechanism is outside the airstream. For electrical drive, see STM, accessory.



Circular spigot

Type FSK 70/40 Ref. no. 0840
For cost effective adaption of rectangular fans into circular ducting systems with Ø 400 mm.



Flexible connectors

Type VS 70/40 Ref. no. 5699
Flexible in-duct connector with flanges on both sides.



– for Ex-fans

Type VS 70/40 Ex Ref. no. 0269



Counterflange

Type GF 70/40 Ref. no. 6924
Flange frames made of galvanised steel for connection to ducting.



Rectangular attenuator

Type KSD 70/40 Ref. no. 8731
For in-duct installation on intake or exhaust side.



Air-duct filter

Type KLF 70/40 G4 No. 8723
Type KLF 70/40 F7 No. 8647
Bag filter with a large cross section area. Galvanised steel casing with flanges on both sides.



Warm water heater battery

Type WHR 2/70/40 No. 8788
Type WHR 4/70/40 No. 8789
For in-duct installation.



Temperature control system for warm water heater battery

Type WHS HE¹⁾ Ref. no. 8319

¹⁾ In model WHR 4/70/40 the heat output is reduced to 2200 l/h.



Accessory details Page

Shutters, grilles and louvres	420, 487 on
Filters, heaters and attenuators	421 on
Temperature control systems for heaters	427, 432 on
Speed controllers and motor full protection devices	525 on

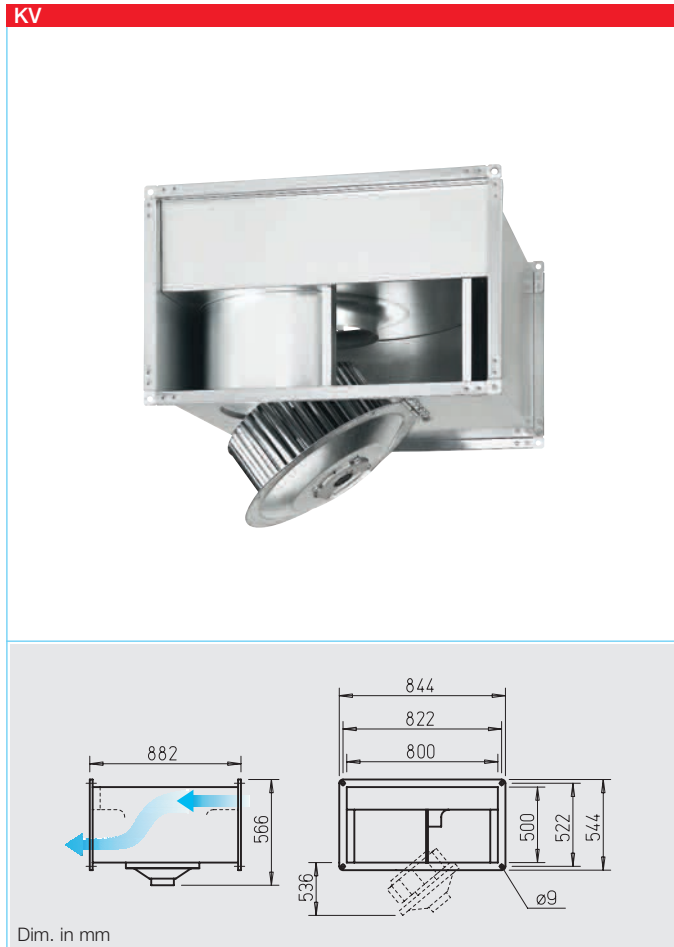

Rectangular centrifugal fan with forward curved impeller blades and swing-out motor impeller unit.

- Low-noise centrifugal impellers in aerodynamic galvanised steel casing for high pressure levels.
- Compact and flat design for use in extract and fresh air systems in commercial and industrial applications.

■ **Specification**

□ **Casing**

Made of galvanised steel and flanged on both ends. Space saving, compact design.

- Easy to clean and service thanks to the swing-out motor impeller unit.

□ **Impeller**

Forward curved centrifugal impeller made of galvanised steel, highly efficient with low noise levels. Aerodynamically optimised casing; intake air flow by means of an inlet nozzle.

□ **Motor**

Totally enclosed, maintenance-free external rotor motor with directly fitted impeller, protected to IP 44. Windings with protection against moisture. Ball bearing mounted

and interference-free. Dynamically balanced with resilient motor mounting bracket for low vibration and low noise operation.

□ **Electrical connection**

Terminal box (IP 55) is mounted with a permanently attached cable.

□ **Motor protection**

Through built-in thermal contacts which must be connected to a motor full protection device.

□ **Speed control**

By voltage reduction using a 5 speed transformer controller (recommended) or an electronic controller (stepless). The performance figures at corresponding voltages are given in the performance curve.

□ **Sound Levels**

Above the performance curve, total values and spectrum are given for:

- Sound level case breakout
 - Sound level intake
 - Sound level exhaust
- The sound power level (on intake) is additionally shown within the performance curve for corresponding control voltages. In the table below you can also find:
- Case breakout sound level at 4 m (free field conditions).

□ **Installation**

Possible in any position. Attention should be paid to accessibility/swing out.

Note	Page
Selection chart	372
Technical description	373
Design guidelines	10 on
Modul. system components	370

Type	Ref. no.	Air flow volume, free discharge	Nominal R.P.M.	Sound press. case breakout	Power consumption		Wiring diagram	Max. air flow temperature at		Weight net approx.	Speed controller 5-step				Motor full protection device to connect built-in thermal contacts	
					motor protect. unit	motor protect. unit		without motor protect. unit	with motor protect. unit		Type	Ref. no.	Type	Ref. no.	Type	Ref. no.
		V m³/h	min⁻¹	dB(A) in 4 m	kW	A	No.	+°C	+°C	kg	Type	Ref. no.	Type	Ref. no.	Type	Ref. no.
3-phase motor, 230/400 V, 50 Hz, protected to IP 44																
KVD 400/8/80/50	5690	5400	640	38	1.29	5.1/2.9	860	70	70	66	TSD 5,5	1503	RDS 4	1316	MD	5849
KVD 400/6/80/50	5691	7600	860	45	2.81	9.1/5.3	860	70	50	70	TSD 7,0	1504	RDS 7	1578	MD	5849

KVD 400/8/80/50

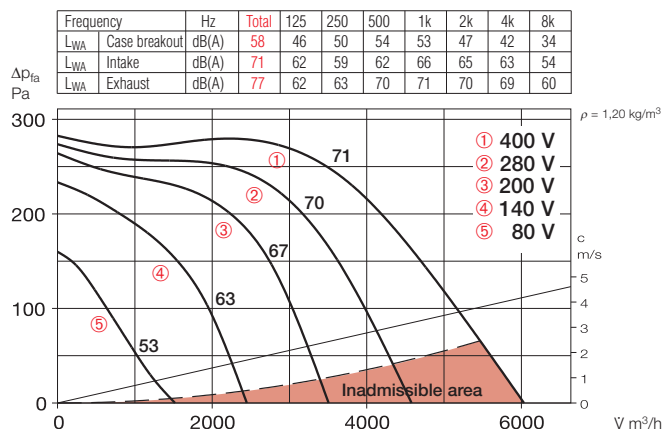

KVD 400/6/80/50

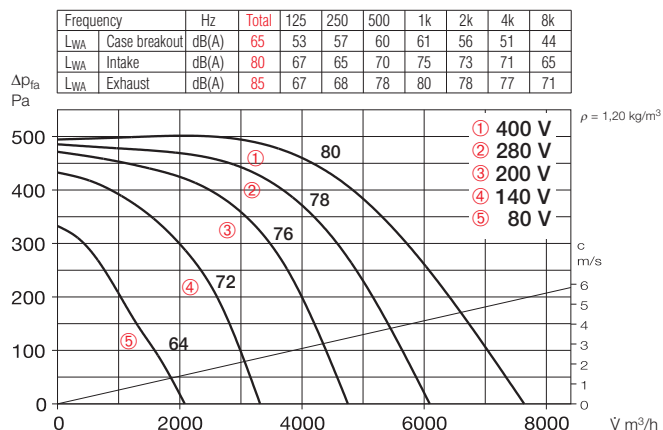

Accessories

Gravity shutter

Type VK 80/50 Ref. no. 0880

External airflow operated gravity shutter made of polymer, light grey.



External louvres

Type WSG 80/50 Ref. no. 0115

Robust construction made of aluminium extrusion profile, natural colour anodised.



Volume control damper for ducting

Type JVK 80/50 Ref. no. 6916

Casing made with flanges on both sides. The control mechanism is outside the airstream. For electrical drive, see STM, accessory.



Circular spigot

Type FSK 80/50 Ref. no. 0842

For cost effective adaption of rectangular fans into circular ducting systems with Ø 500 mm.



Flexible connectors

Type VS 80/50 Ref. no. 5700

Flexible in-duct connector with flanges on both sides.



Counterflange

Type GF 80/50 Ref. no. 6925

Flange frames made of galvanised steel for connection to ducting.



Rectangular attenuator

Type KSD 80/50 Ref. no. 8732

For in-duct installation on intake or exhaust side.



Air-duct filter

Type KLF 80/50 G4 No. 8670

Type KLF 80/50 F7 No. 8654

Bag filter with a large cross section area. Galvanised steel casing with flanges on both sides.



Warm water heater battery

Type WHR 2/80/50 No. 8795

Type WHR 4/80/50 No. 8796

For in-duct installation.

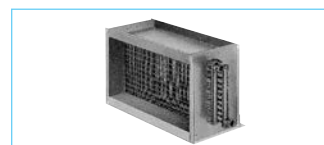

Accessory details Page

Shutters, grilles and louvres	420, 487 on
Filters, heaters and attenuators	421 on
Speed controllers and motor full protection devices	525 on

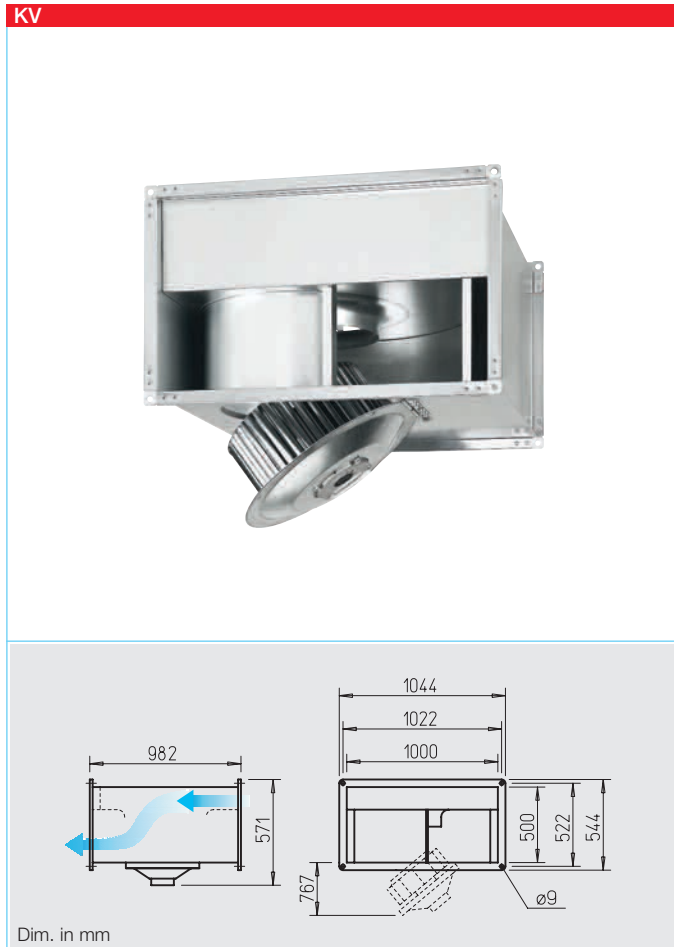

Rectangular centrifugal fan with forward curved impeller blades and swing-out motor impeller unit.

- Low-noise centrifugal impellers in aerodynamic galvanised steel casing for high pressure levels.
- Compact and flat design for use in extract and fresh air systems in commercial and industrial applications.

■ **Specification**

□ **Casing**

Made of galvanised steel and flanged on both ends. Space saving, compact design.

- Easy to clean and service thanks to the swing-out motor impeller unit.

□ **Impeller**

Forward curved centrifugal impeller made of galvanised steel, highly efficient with low noise levels. Aerodynamically optimised casing; intake air flow by means of an inlet nozzle.

□ **Motor**

Totally enclosed, maintenance-free external rotor motor with directly fitted impeller, protected to IP 44. Windings with protection against moisture. Ball bearing mounted and interference-free.

Dynamically balanced with resilient motor mounting bracket for low vibration and low noise operation.

□ **Electrical connection**

Terminal box (IP 55) is mounted with a permanently attached cable.

□ **Motor protection**

Through built-in thermal contacts which must be connected to a motor full protection device.

□ **Speed control**

By voltage reduction using a 5 speed transformer controller (recommended) or an electronic controller (stepless). The performance figures at corresponding voltages are given in the performance curve.

□ **Sound Levels**

Above the performance curve, total values and spectrum are given for:

- Sound level case breakout
 - Sound level intake
 - Sound level exhaust
- The sound power level (on intake) is additionally shown within the performance curve for corresponding control voltages. In the table below you can also find:
- Case breakout sound level at 4 m (free field conditions).

□ **Installation**

Possible in any position. Attention should be paid to accessibility/swing out.

Note	Page
Selection chart	372
Technical description	373
Design guidelines	10 on
Modul. system components	370

Type	Ref. no.	Air flow volume, free discharge	Nominal R.P.M.	Sound press. case breakout	Power consumption		Wiring diagram	Max. air flow temperature at		Weight net approx.	Speed controller 5-step				Motor full protection device to connect built-in thermal contacts	
					motor protect. unit	motor protect. unit		Type	Ref. no.		Type	Ref. no.	Type	Ref. no.		
		V m³/h	min⁻¹	dB(A) in 4 m	kW	A	No.	+°C	+°C	kg	Type	Ref. no.	Type	Ref. no.	Type	Ref. no.
3-phase motor, 230/400 V, 50 Hz, protected to IP 44																
KVD 450/8/100/50	5692	7600	690	46	2.26	8.6/5.0	860	60	50	90	TSD 7,0	1504	RDS 7	1578	MD	5849
KVD 450/6/100/50	5693	8500	870	50	3.65	11.6/6.7	860	70	50	90	TSD 11	1513	RDS 11	1332	MD	5849

KVD 450/8/100/50

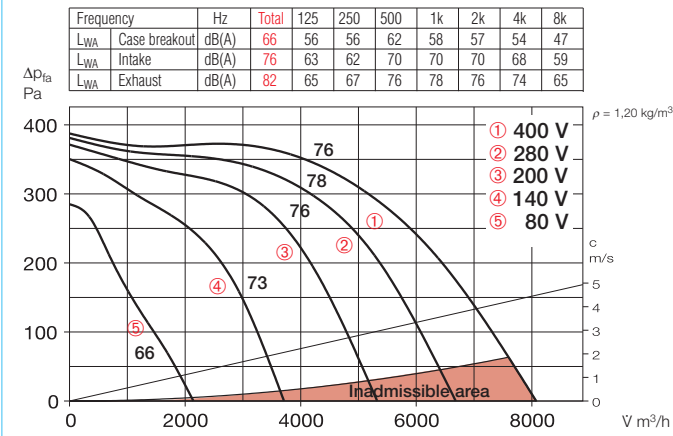

KVD 450/6/100/50

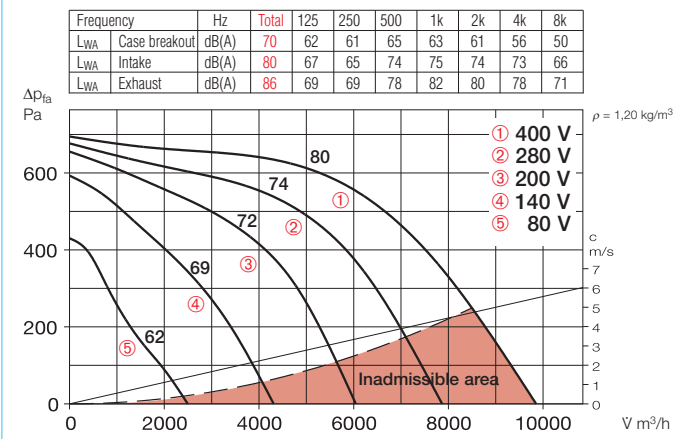

Accessories

Gravity shutter

Type VK 100/50 Ref. no. 0881
External airflow operated gravity shutter made of polymer, light grey.



External louvres

Type WSG 100/50 Ref. no. 0116
Robust construction made of aluminium extrusion profile, natural colour anodised.



Volume control damper for ducting

Type JVK 100/50 Ref. no. 6917
Casing made with flanges on both sides. The control mechanism is outside the airstream. For electrical drive, see STM, accessory.



Circular spigot

Type FSK 100/50 Ref. no. 0843
For cost effective adaption of rectangular fans into circular ducting systems with Ø 500 mm.



Flexible connectors

Type VS 100/50 Ref. no. 5701
Flexible in-duct connector with flanges on both sides.



Counterflange

Type GF 100/50 Ref. no. 6926
Flange frames made of galvanised steel for connection to ducting.



Rectangular attenuator

Type KSD 100/50 Ref. no. 8733
For in-duct installation on intake or exhaust side.



Air-duct filter

Type KLF 100/50 G4 No. 8671
Type KLF 100/50 F7 No. 8655
Bag filter with a large cross section area. Galvanised steel casing with flanges on both sides.



Warm water heater battery

Type WHR 2/100/50 No. 8797
Type WHR 4/100/50 No. 8798
For in-duct installation.

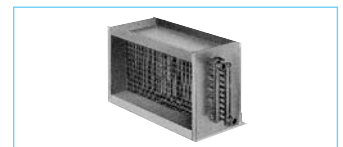

Accessory details Page

Shutters, grilles and louvres	420, 487 on
Filters, heaters and attenuators	421 on
Speed controllers and motor full protection devices	525 on



Rectangular EC centrifugal fan with backward curved impeller and swing-out motor impeller unit.

- Highly efficient EC-motor for lowest operating costs.
 - High performance with high efficiency impellers.
 - Use in extract and fresh air systems for conveying higher air flow volume.
 - Suitable for extraction of polluted air.
- Special features**
- High pressure and high volume specific centrifugal fan with high efficiency.
 - Particularly easy to service (cleaning) thanks to the swing-out motor impeller unit.
 - For cleaning, easy access and therefore suitable for extraction of polluted air.
 - Compact design, less space requirement and straight through-flow.

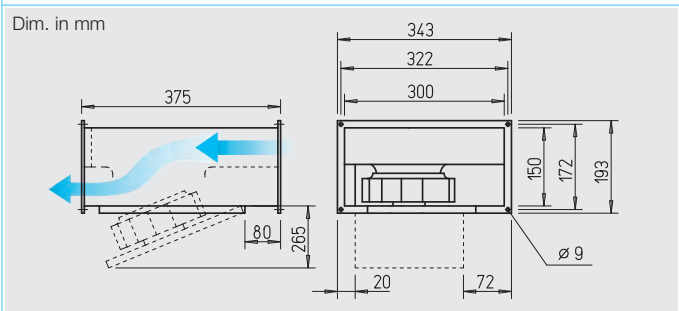

- Specification**
- **Casing**
Made of galvanised steel. Flanged (20 mm) on both ends for in-duct installation.
 - **Impeller**
Centrifugal, backward curved impeller made of polymer. Aerodynamically optimised, intake air flow by means of an inlet nozzle.
 - **Motor**
Energy saving, speed controllable EC-external rotor motors with highest efficiency, protection to IP 44. With ball bearings, maintenance-free and interference-free. Motor and impeller are dynamically balanced.

- **Motor protection**
Integrated electronic temperature monitoring for EC-motor and electronics.
- **Speed control**
Stepless speed control with potentiometer or stepless speed control with universal control system (see table). Duties at different speeds are exemplarily given in the performance curve.
- **Electrical connection**
Terminal box (IP 54) fitted to flying lead.
- **Installation**
Installation in any position. Allowance must be made for the motor swing out access.

Note	Page
Selection chart	372
Technical description	373
Design guidelines	10 on
Modul. system components	370

- Sound levels**
- Total sound power levels and the spectrum figures in dB(A) are given for:
- Sound level case breakout
 - Sound level intake
 - Sound level exhaust
- In the table below as well as underneath the performance curve you can find additionally the sound pressure level at 4 m (free field conditions).

Type	Ref. no.	Air flow volume (FID)	Nominal R.P.M.	Sound press. case breakout	Motor power	Current	Wiring diagram	max. air flow temperature	Weight net approx.	Universal control system		Speed-potentiometer flush		Speed-potentiometer surface	
										Type	Ref. no.	Type	Ref. no.	Type	Ref. no.
Single Phase, 230 V, 50/60 Hz, EC motor, protection to IP 44															
KRW EC 180/30/15	8168	660	3700	44	0.11	0.90	979	60	6.2	EUR EC¹⁾²⁾	1347	PU 10¹⁾	1734	PA 10¹⁾	1735

1) Multiple EC fans can normally be connected 2) alternative electronic differential pressure/temp. controller (EDR/ETR, No. 1437/1438) or three-step speed controller (SU/SA, No. 4266/4267), s. accessories

KRW EC 180/30/15

Frequency	Hz	Total	125	250	500	1k	2k	4k	8k
L _{WA} Case breakout	dB(A)	64	50	52	61	57	55	49	42
L _{WA} Intake	dB(A)	78	63	72	74	67	66	67	60
L _{WA} Exhaust	dB(A)	84	66	76	79	75	78	74	66

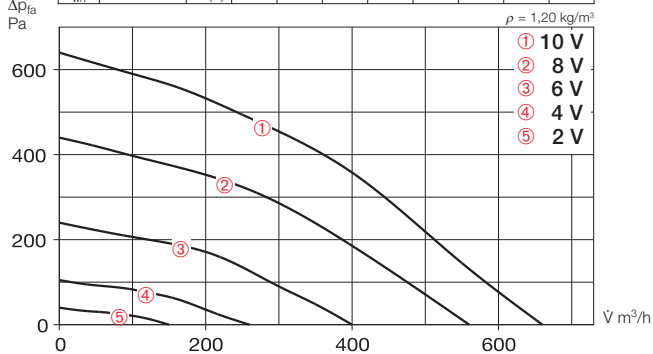

Free discharge						
Voltage V	n min ⁻¹	Ṃ m³/h	P W	I A	Lp dB(A)	SFP kW/m²/s
10	3700	660	113	0,89	44	0,62
8	3120	560	70	0,58	40	0,45
6	2300	400	30	0,25	34	0,27
4	1500	260	10	0,10	26	0,14

■ Accessories

Gravity shutter

Type VK 30/15 Ref. no. 0735

Air stream operated louvres, light grey polymer.



External louver

Type WSG 30/15 Ref. no. 0108

Heavy duty construction made from profile anodised aluminium extrusion.



Vol. control damper for ducting

Type JVK 30/15 Ref. no. 6927

Casing with flanges on both sides. The control mechanism is outside the airstream. For electrical drive, see STM, accessory.



Circular spigot

Type FSK 30/15 Ref. no. 0831

For cost effective adaption of rectangular fans into circular ducting systems with Ø 160 mm.



Flexible connectors

Type VS 30/15 Ref. no. 6928

Flexible in-duct connector with flanges on both sides.



Counterflange

Type GF 30/15 Ref. no. 6918

Flange frames made of galvanised steel for connection to ducting.



■ Accessory details Page

Shutters, grilles and louvres	420, 487 on
Filters, heater batteries and attenuators	421 on
Universal control system, electronic controller, speed-potentiometer	539 on



Rectangular EC centrifugal fan with backward curved impeller and swing-out motor impeller unit.

- Highly efficient EC-motor for lowest operating costs.
 - High performance with high efficiency impellers.
 - Use in extract and fresh air systems for conveying higher air flow volume.
 - Suitable for extraction of polluted air.
- Special features**
- High pressure and high volume specific centrifugal fan with high efficiency.
 - Particularly easy to service (cleaning) thanks to the swing-out motor impeller unit.
 - For cleaning, easy access and therefore suitable for extraction of polluted air.
 - Compact design, less space requirement and straight through-flow.

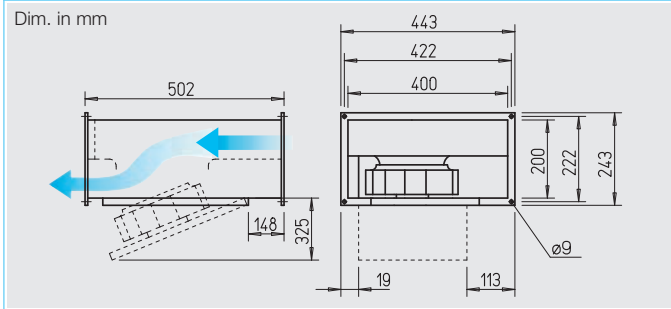

- Specification**
- **Casing**
Made of galvanised steel. Flanged (20 mm) on both ends for in-duct installation.
 - **Impeller**
Centrifugal, backward curved impeller made of polymer. Aerodynamically optimised, intake air flow by means of an inlet nozzle.
 - **Motor**
Energy saving, speed control-able EC-external rotor motors with highest efficiency, protection to IP 44. With ball bearings, maintenance-free and interference-free. Motor and impeller are dynamically balanced.
- **Motor protection**
Integrated electronic temperature monitoring for EC-motor and electronics.
- **Speed control**
Stepless speed control with potentiometer or stepless speed control with universal control system (see table). Duties at different speeds are exemplarily given in the performance curve.
- **Electrical connection**
Terminal box (IP 54) fitted to flying lead.
- **Installation**
Installation in any position. Allowance must be made for the motor swing out access.

Note	Page
Selection chart	372
Technical description	373
Design guidelines	10 on
Modul. system components	370

- Sound levels**
- Total sound power levels and the spectrum figures in dB(A) are given for:
- Sound level case breakout
 - Sound level intake
 - Sound level exhaust
- In the table below as well as underneath the performance curve you can find additionally the sound pressure level at 4 m (free field conditions).

Type	Ref. no.	Air flow volume (FID)	Nominal R.P.M.	Sound press. case breakout	Motor power	Current	Wiring diagram	max. air flow temperature	Weight net approx.	Universal control system		Speed-potentiometer flush		Speed-potentiometer surface	
										Type	Ref. no.	Type	Ref. no.	Type	Ref. no.
Single Phase, 230 V, 50/60 Hz, EC motor, protection to IP 44															
KRW EC 225/40/20	8169	1430	2650	46	0,16	1,26	979	60	9,8	EUR EC¹⁾²⁾	1347	PU 10¹⁾	1734	PA 10¹⁾	1735

1) Multiple EC fans can normally be connected 2) alternative electronic differential pressure/temp. controller (EDR/ETR, No. 1437/1438) or three-step speed controller (SU/SA, No. 4266/4267), s. accessories

KRW EC 225/40/20

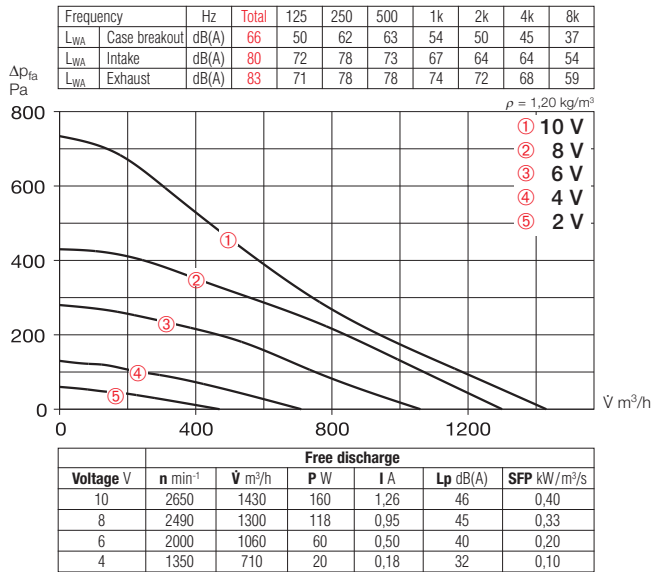

Accessory details Page

Shutters, grilles and louvres	420, 487 on
Filters, heater batteries and attenuators	421 on
Temperature control systems for heater batteries	427, 432 on
Universal control system, electronic controller, speed-potentiometer	539 on

Accessories

Gravity shutter

Type VK 40/20 Ref. no. 0874

Air stream operated louvres, light grey polymer.



External louver

Type WSG 40/20 Ref. no. 0109

Heavy duty construction made from profile anodised aluminium extrusion.



Vol. control damper for ducting

Type JVK 40/20 Ref. no. 6910

Casing with flanges on both sides. The control mechanism is outside the airstream. For electrical drive, see STM, accessory.

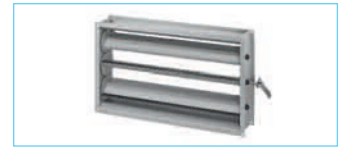

Circular spigot

Type FSK 40/20 Ref. no. 0832

For cost effective adaption of rectangular fans into circular ducting systems with Ø 200 mm.

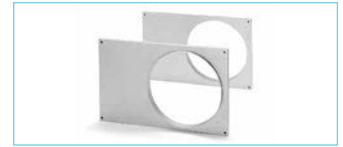

Flexible connectors

Type VS 40/20 Ref. no. 5694

Flexible in-duct connector with flanges on both sides.

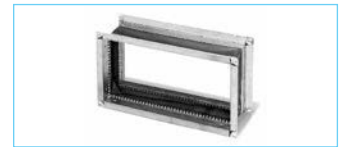

Counterflange

Type GF 40/20 Ref. no. 6919

Flange frames made of galvanised steel for connection to ducting.



Rectangular attenuator

Type KSD 40/20 Ref. no. 8728

For in-duct installation on intake or exhaust side.



Air-duct filter

Type KLF 40/20 G4 No. 8720

Type KLF 40/20 F7 No. 8644

Bag filter with a large cross section area. Galvanised steel casing with flanges on both sides.



Electric heater battery

Type EHR-K 6/40/20 No. 8702

Type EHR-K 15/40/20 No. 8703

Heating elements enclosed in a galvanised steel casing with connecting flanges on both sides.

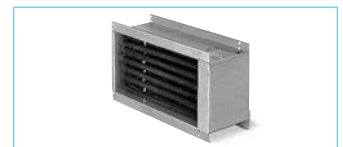

Temperature control system for electric heater battery

Type EHSD 16 Ref. no. 5003



Warm water heater battery

Type WHR 2/40/20 No. 8782

Type WHR 4/40/20 No. 8783

For in-duct installation.

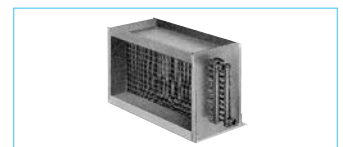

Temperature control system for warm water heater battery

Type WHS HE Ref. no. 8319



KR EC

Suitable for polluted air.



(Fig. similar)

Dim. in mm

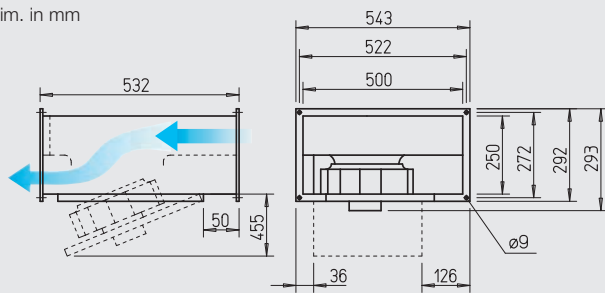

SKR EC – Sound insulated



Lowest sound levels for intake and case breakout at higher power density.

Use in extract and fresh air systems with specific requirements for low noise levels.



Dim. in mm

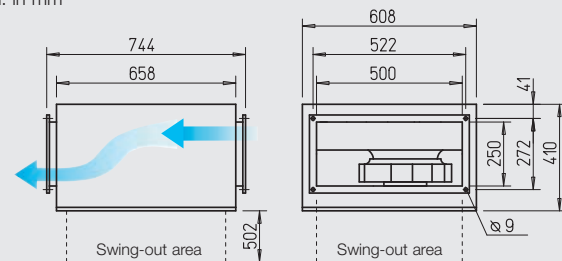

- **Features of KR EC and SKR EC**
 - Highly efficient EC-motor for lowest operating costs.
 - High pressure and high volume with high efficiency centrifugal fan.
 - Particularly easy to service (cleaning) thanks to the swing-out motor impeller unit.
 - For cleaning, easy access and therefore suitable for extraction of polluted air.
 - Straight through-flow.
 - Compact design, convenient installation.
- **Special features of SKR EC**
 - Lowest sound levels for intake and case breakout at higher power density.

- **Specification**
 - **Casing KR EC**
Made of galvanised steel. Flanged (20 mm) on both ends for in-duct installation.
 - **Casing SKR EC**
As above, but with additional sound insulation with 50 mm thick mineral fibre board, inside lined with a sound deadening perforated plate.
- **Common features of KR EC and SKR EC**
 - **Impeller**
Centrifugal, backward curved impeller made of polymer. Aerodynamically optimised, intake air flow by means of an inlet nozzle.

- **Motor**
Energy-saving, speed controllable EC-external rotor motors with highest efficiency, protection to IP 44 (SKR EC IP 54). With ball bearings, maintenance-free and interference-free. Motor and impeller are dynamically balanced.
- **Motor protection**
Integrated electronic temperature monitoring for EC-motor and electronics.
- **Speed control**
Stepless speed control with potentiometer or stepless speed control with universal control system (see table). Duties at different speeds are exemplarily given in the performance curve.

- **Electrical connection**
Terminal box (IP 54) fitted to flying lead.
- **Installation**
Installation in any position. Allowance must be made for the motor swing out access.
- **Sound levels**
Total sound power levels and the spectrum figures in dB(A) are given for:
 - Sound level case breakout
 - Sound level intake
 - Sound level exhaust
 In the table below as well as underneath the performance curve you can find additionally the sound pressure level at 4 m (free field conditions).

Type	Ref. no.	Air flow volume (FID)	Nominal R.P.M.	Sound press. case breakout	Motor power	Current	Wiring diagram	max. air flow temperature	Weight net approx.	Universal control system		Speed-potentiometer flush		Speed-potentiometer surface	
										Type	Ref. no.	Type	Ref. no.	Type	Ref. no.
Single Phase, 230 V, 50/60 Hz, EC motor, protection to IP 44															
KREW EC 315/50/25	8170	1410	3080	44	0.16	1.24	979	60	13.8	EUR EC ¹⁾²⁾	1347	PU 10 ¹⁾	1734	PA 10 ¹⁾	1735
Sound insulated model SKR EC – single phase, 230 V, 50/60 Hz, EC motor, protection to IP 54															
SKRW EC 315/50/25	8182	2600	2020	47	0.36	1.57	1066	60	34.0	EUR EC ¹⁾²⁾	1347	PU 10 ¹⁾	1734	PA 10 ¹⁾	1735

1) Multiple EC fans can normally be connected 2) alternative electronic differential pressure/temp. controller (EDR/ETR, No. 1437/1438) or three-step speed controller (SU/SA, No. 4266/4267), s. accessories

KRW EC 315/50/25

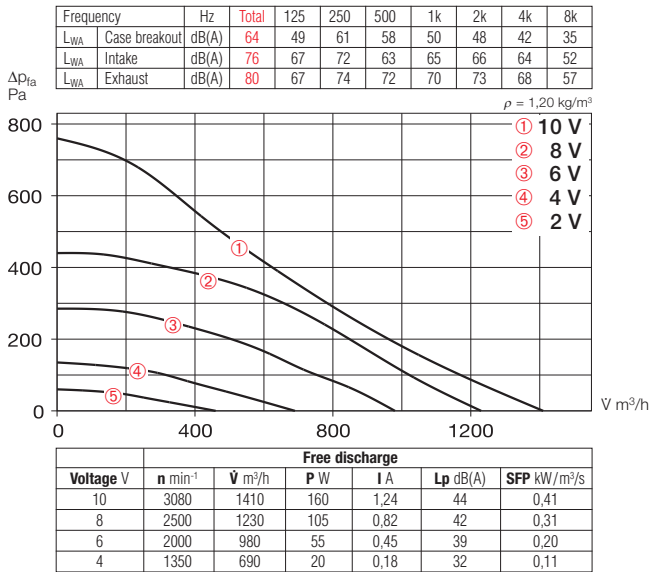

SKRW EC 315/50/25

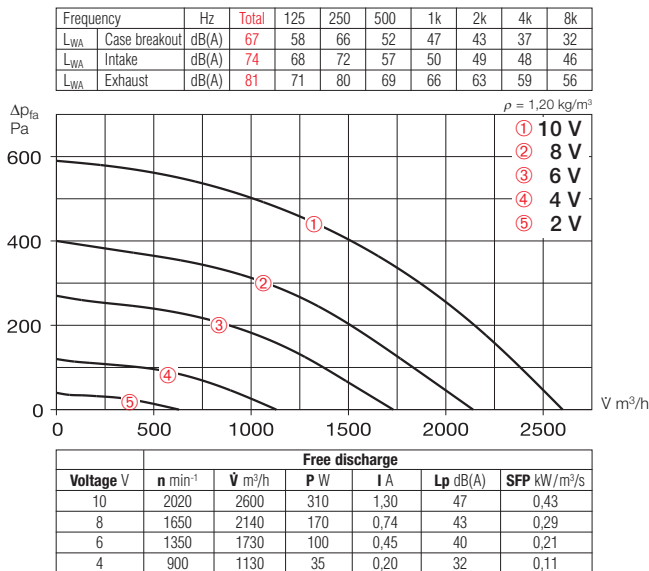

Accessories

Gravity shutter

Type VK 50/25 Ref. no. 0875

Air stream operated louvres, light grey polymer.



External louver

Type WSG 50/25 Ref. no. 0110

Heavy duty construction made from profile anodised aluminium extrusion.



Vol. control damper for ducting

Type JVK 50/25 Ref. no. 6911

Casing with flanges on both sides. The control mechanism is outside the airstream. For electrical drive, see STM, accessory.



Circular spigot

Type FSK 50/25 Ref. no. 0833

For cost effective adaption of rectangular fans into circular ducting systems with Ø 250 mm.



Flexible connectors

Type VS 50/25 Ref. no. 5695

Flexible in-duct connector with flanges on both sides.



Counterflange

Type GF 50/25 Ref. no. 6920

Flange frames made of galvanised steel for connection to ducting.



Rectangular attenuator

Type KSD 50/25-30 No. 8729

For in-duct installation on intake or exhaust side.



Air-duct filter

Type KLF 50/25-30 G4 No. 8721

Type KLF 50/25-30 F7 No. 8645

Bag filter with a large cross section area. Galvanised steel casing with flanges on both sides.



Electric heater battery

Type EHR-K 8/50/25-30 No. 8704

Type EHR-K 24/50/25-30 No. 8705

Heating elements enclosed in a galvanised steel casing with connecting flanges on both sides.

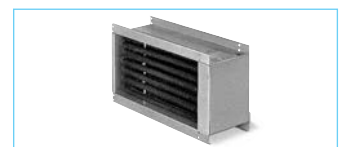

Temperature control system for electric heater battery

Type EHSD 16 Ref. no. 5003



Warm water heater battery

Type WHR 2/50/25-30 No. 8784

Type WHR 4/50/25-30 No. 8785

For in-duct installation.

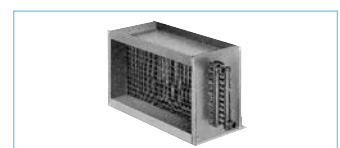

Temperature control system for warm water heater battery

Type WHS HE Ref. no. 8319



Accessory details Page

Shutters, grilles and louvres	420, 487 on
Filters, heater batteries and attenuators	421 on
Temperature control systems for heater batteries	427, 432 on
Universal control system, electronic controller, speed-potentiometer	539 on

KR EC

Suitable for polluted air.



(Fig. similar)

Dim. in mm

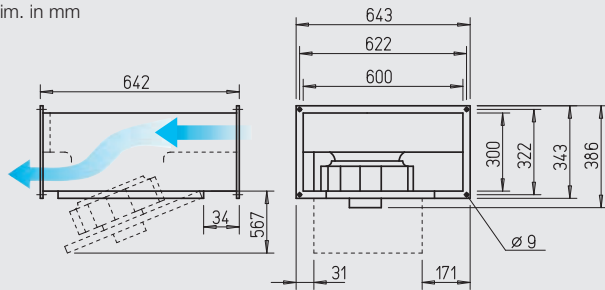

SKR EC – Sound insulated



Lowest sound levels for intake and case breakout at higher power density.

Use in extract and fresh air systems with specific requirements for low noise levels.



Dim. in mm

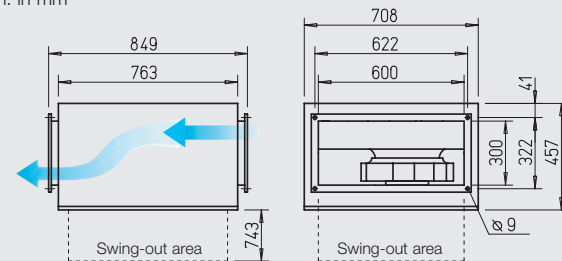

- **Features of KR EC and SKR EC**
 - Highly efficient EC-motor for lowest operating costs.
 - High pressure and high volume with high efficiency centrifugal fan.
 - Particularly easy to service (cleaning) thanks to the swing-out motor impeller unit.
 - For cleaning, easy access and therefore suitable for extraction of polluted air.
 - Straight through-flow.
 - Compact design, convenient installation.
- **Special features of SKR EC**
 - Lowest sound levels for intake and case breakout at higher power density.

- **Specification**
 - **Casing KR EC**
Made of galvanised steel. Flanged (20 mm) on both ends for in-duct installation.
 - **Casing SKR EC**
As above, but with additional sound insulation with 50 mm thick mineral fibre board, inside lined with a sound deadening perforated plate.
- **Common features of KR EC and SKR EC**
 - **Impeller**
Centrifugal, backward curved impeller made of polymer. Aerodynamically optimised, intake air flow by means of an inlet nozzle.

- **Motor**
Energy-saving, speed controllable EC-external rotor motors with highest efficiency, protection to IP 44. With ball bearings, maintenance-free and interference-free. Motor and impeller are dynamically balanced.
- **Motor protection**
Integrated electronic temperature monitoring for EC-motor and electronics.
- **Speed control**
Stepless speed control with potentiometer or stepless speed control with universal control system (see table). Duties at different speeds are exemplarily given in the performance curve.

- **Electrical connection**
Terminal box (IP 54) fitted to flying lead.
- **Installation**
Installation in any position. Allowance must be made for the motor swing out access.
- **Sound levels**
Total sound power levels and the spectrum figures in dB(A) are given for:
 - Sound level case breakout
 - Sound level intake
 - Sound level exhaust
 In the table below as well as underneath the performance curve you can find additionally the sound pressure level at 4 m (free field conditions).

Type	Ref. no.	Air flow volume (FID)	Nominal R.P.M.	Sound press. case breakout	Motor power	Current	Wiring diagram	max. air flow temperature	Weight net approx.	Universal control system		Speed-potentiometer flush		Speed-potentiometer surface	
										Type	Ref. no.	Type	Ref. no.	Type	Ref. no.
Single Phase, 230 V, 50/60 Hz, EC motor, protection to IP 54															
KRW EC 355/60/30	8171	3110	1650	46	0.37	1.59	1066	60	25.0	EUR EC ¹⁾²⁾	1347	PU 10 ¹⁾	1734	PA 10 ¹⁾	1735
Sound insulated model SKR EC – single phase, 230 V, 50/60 Hz, EC motor, protection to IP 54															
SKRW EC 355/60/30	8176	3950	2200	51	0.84	3.94	982	60	44.5	EUR EC ¹⁾²⁾	1347	PU 10 ¹⁾	1734	PA 10 ¹⁾	1735
Sound insulated model SKR EC – three phase, 400 V, 50/60 Hz, EC motor, protection to IP 54															
SKRD EC 355/60/30	8296	4550	2500	52	1.16	1.81	1005	60	44.5	EUR EC ¹⁾²⁾	1347	PU 10 ¹⁾	1734	PA 10 ¹⁾	1735

1) Multiple EC fans can normally be connected 2) alternative electronic differential pressure/temp. controller (EDR/ETR, No. 1437/1438) or three-step speed controller (SU/SA, No. 4266/4267), s. accessories

KRW EC 355/60/30

Frequency	Hz	Total	125	250	500	1k	2k	4k	8k
L _{WA} Case breakout		dB(A) 66	59	63	58	54	48	42	40
L _{WA} Intake		dB(A) 78	73	76	66	61	61	58	58
L _{WA} Exhaust		dB(A) 81	70	78	74	69	67	63	62

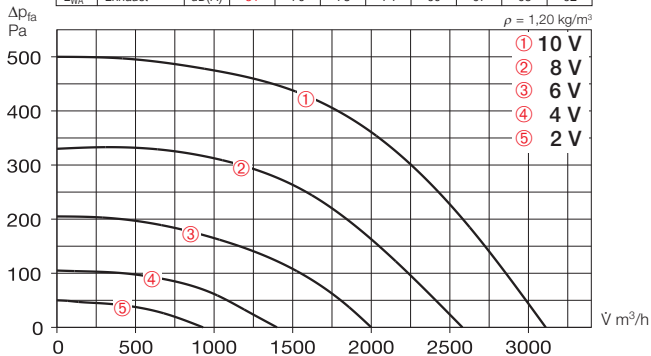

Free discharge						
Voltage V	n min ⁻¹	V̇ m ³ /h	P W	I A	Lp dB(A)	SFP kW/m ² /s
10	1650	3110	275	1,20	46	0,32
8	1350	2580	150	0,65	42	0,21
6	1050	2000	75	0,35	37	0,14
4	750	1400	35	0,20	28	0,09

SKRW EC 355/60/30

Frequency	Hz	Total	125	250	500	1k	2k	4k	8k
L _{WA} Case breakout		dB(A) 71	58	71	55	52	49	44	39
L _{WA} Intake		dB(A) 78	72	75	64	58	56	52	50
L _{WA} Exhaust		dB(A) 84	74	83	73	72	69	65	61

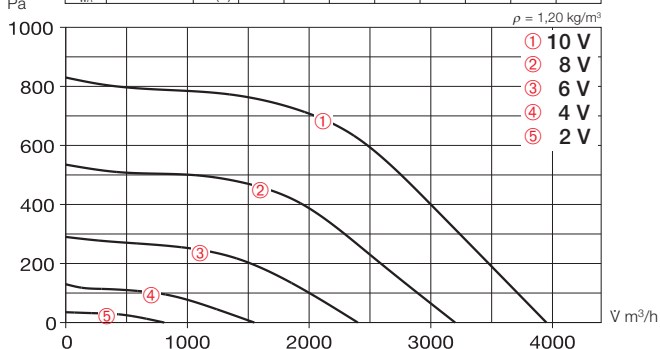

Free discharge						
Voltage V	n min ⁻¹	V̇ m ³ /h	P W	I A	Lp dB(A)	SFP kW/m ² /s
10	2200	3950	670	3,10	51	0,61
8	1750	3200	360	1,70	46	0,41
6	1300	2400	160	0,74	40	0,24
4	850	1550	60	0,36	32	0,14

SKRD EC 355/60/30

Frequency	Hz	Total	125	250	500	1k	2k	4k	8k
L _{WA} Case breakout		dB(A) 72	61	71	61	57	53	48	42
L _{WA} Intake		dB(A) 80	74	76	68	62	60	56	53
L _{WA} Exhaust		dB(A) 86	76	84	77	76	74	69	64

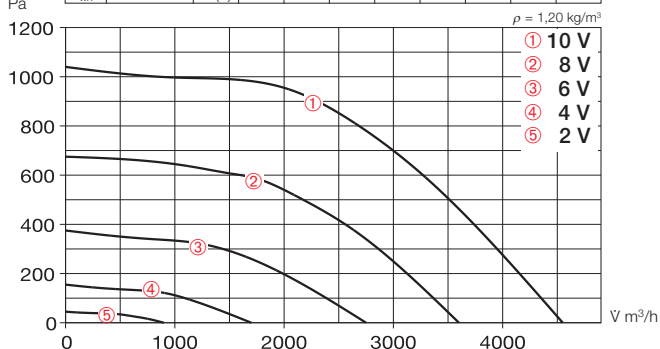

Free discharge						
Voltage V	n min ⁻¹	V̇ m ³ /h	P W	I A	Lp dB(A)	SFP kW/m ² /s
10	2500	4550	930	1,50	52	0,74
8	2000	3600	500	0,82	47	0,50
6	1450	2750	220	0,45	42	0,29
4	950	1700	80	0,26	33	0,17

Accessories

Gravity shutter

Type VK 60/30 Ref. no. 0877

Air stream operated louvres, light grey polymer.



External louver

Type WSG 60/30 Ref. no. 0112

Heavy duty construction made from profile anodised aluminium extrusion.



Vol. control damper for ducting

Type JVK 60/30 Ref. no. 6913

Casing with flanges on both sides. The control mechanism is outside the airstream. For electrical drive, see STM, accessory.



Circular spigot

Type FSK 60/30 Ref. no. 0834

For cost effective adaption of rectangular fans into circular ducting systems with Ø 315 mm.



Flexible connectors

Type VS 60/30 Ref. no. 5697

Flexible in-duct connector with flanges on both sides.



Counterflange

Type GF 60/30 Ref. no. 6922

Flange frames made of galvanised steel for connection to ducting.



Rectangular attenuator

Type KSD 60/30-35 No. 8730

For in-duct installation on intake or exhaust side.



Air-duct filter

Type KLF 60/30-35 G4 No. 8722

Type KLF 60/30-35 F7 No. 8646

Bag filter with a large cross section area. Galvanised steel casing with flanges on both sides.



Electric heater battery

Type EHR-K 15/60/30-35 No. 8706

Type EHR-K 30/60/30-35 No. 8707

Heating elements enclosed in a galvanised steel casing with connecting flanges on both sides.



Temperature control system for electric heater battery

Type EHSD 16 Ref. no. 5003



Warm water heater battery

Type WHR 2/60/30-35 No. 8786

Type WHR 4/60/30-35 No. 8787

For in-duct installation.

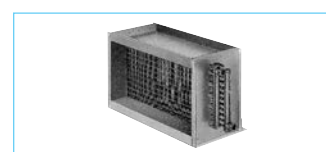

Temperature control system for warm water heater battery

Type WHS HE¹⁾ Ref. no. 8319

¹⁾ In model WHR 4/60/30-35 the heat output is reduced to 2200 l/h.

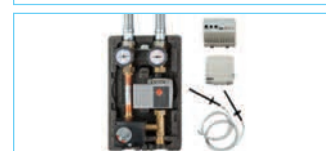

KR EC

Suitable for polluted air.



(Fig. similar)

Dim. in mm

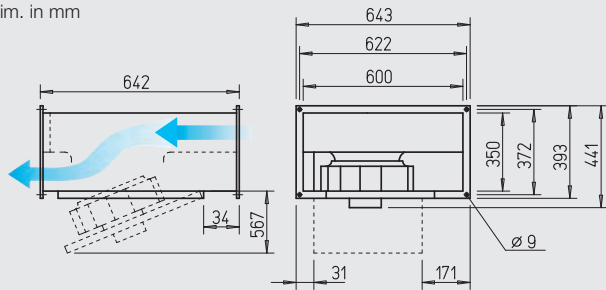

SKR EC – Sound insulated



Lowest sound levels for intake and case breakout at higher power density.

Use in extract and fresh air systems with specific requirements for low noise levels.



Dim. in mm

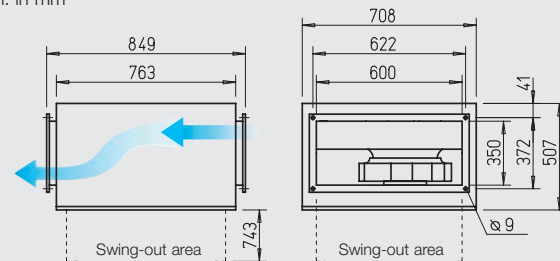

- **Features of KR EC and SKR EC**
 - Highly efficient EC-motor for lowest operating costs.
 - High pressure and high volume with high efficiency centrifugal fan.
 - Particularly easy to service (cleaning) thanks to the swing-out motor impeller unit.
 - For cleaning, easy access and therefore suitable for extraction of polluted air.
 - Straight through-flow.
 - Compact design, convenient installation.
- **Special features of SKR EC**
 - Lowest sound levels for intake and case breakout at higher power density.

- **Specification**
 - **Casing KR EC**
Made of galvanised steel. Flanged (20 mm) on both ends for in-duct installation.
 - **Casing SKR EC**
As above, but with additional sound insulation with 50 mm thick mineral fibre board, inside lined with a sound deadening perforated plate.
- **Common features of KR EC and SKR EC**
 - **Impeller**
Centrifugal, backward curved impeller made of polymer. Aerodynamically optimised, intake air flow by means of an inlet nozzle.

- **Motor**
Energy-saving, speed controllable EC-external rotor motors with highest efficiency, protection to IP 44 (SKR EC IP 54). With ball bearings, maintenance-free and interference-free. Motor and impeller are dynamically balanced.
- **Motor protection**
Integrated electronic temperature monitoring for EC-motor and electronics.
- **Speed control**
Stepless speed control with potentiometer or stepless speed control with universal control system (see table). Duties at different speeds are exemplarily given in the performance curve.

- **Electrical connection**
Terminal box (IP 54) fitted to flying lead.
- **Installation**
Installation in any position. Allowance must be made for the motor swing out access.
- **Sound levels**
Total sound power levels and the spectrum figures in dB(A) are given for:
 - Sound level case breakout
 - Sound level intake
 - Sound level exhaust
 In the table below as well as underneath the performance curve you can find additionally the sound pressure level at 4 m (free field conditions).

Type	Ref. no.	Air flow volume (FID)	Nominal R.P.M.	Sound press. case breakout	Motor power	Current	Wiring diagram	max. air flow temperature	Weight net approx.	Universal control system		Speed-potentiometer flush		Speed-potentiometer surface	
										Type	Ref. no.	Type	Ref. no.	Type	Ref. no.
Single Phase, 230 V, 50/60 Hz, EC motor, protection to IP 54															
KRW EC 400/60/35	8172	4460	2200	56	0.88	4.04	982	60	30.4	EUR EC ¹⁾²⁾	1347	PU 10 ¹⁾	1734	PA 10 ¹⁾	1735
Sound insulated model SKR EC – 1-phase, 1~, 230 V, 50/60 Hz, EC motor, protection to IP 54															
SKRW EC 400/60/35	8177	4200	2200	51	0.84	3.92	982	60	46.0	EUR EC ¹⁾²⁾	1347	PU 10 ¹⁾	1734	PA 10 ¹⁾	1735
Sound insulated model SKR EC – 3-phase, 3~, 400 V, 50/60 Hz, EC motor, protection to IP 54															
SKRD EC 400/60/35	8297	5000	2500	51	1.17	1.81	1005	60	46.0	EUR EC ¹⁾²⁾	1347	PU 10 ¹⁾	1734	PA 10 ¹⁾	1735

1) Multiple EC fans can normally be connected 2) alternative electronic differential pressure/temp. controller (EDR/ETR, No. 1437/1438) or three-step speed controller (SU/SA, No. 4266/4267), s. accessories

KRW EC 400/60/35

Frequency	Hz	Total	125	250	500	1k	2k	4k	8k
L _{WA} Case breakout		dB(A) 76	57	76	62	61	57	50	45
L _{WA} Intake		dB(A) 86	72	85	72	71	69	66	61
L _{WA} Exhaust		dB(A) 90	74	88	81	80	77	72	66

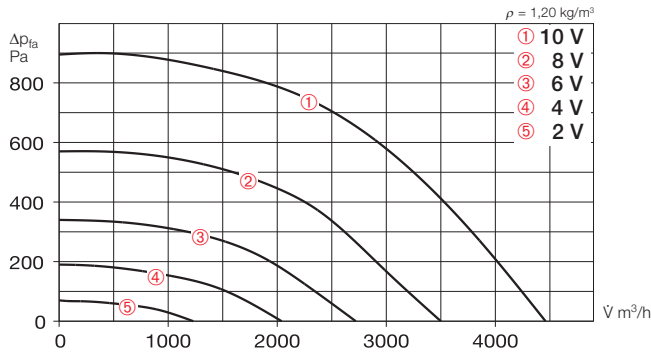

Free discharge						
Voltage V	n min ⁻¹	Ṃ m³/h	P W	I A	Lp dB(A)	SFP kW/m²/s
10	2200	4460	635	3,00	56	0,51
8	1750	3500	340	1,60	50	0,35
6	1350	2720	160	0,73	43	0,21
4	1000	2040	75	0,37	37	0,13

SKRW EC 400/60/35

Frequency	Hz	Total	125	250	500	1k	2k	4k	8k
L _{WA} Case breakout		dB(A) 71	55	70	53	49	49	46	44
L _{WA} Intake		dB(A) 76	69	74	63	56	53	50	48
L _{WA} Exhaust		dB(A) 83	71	82	70	71	69	63	60

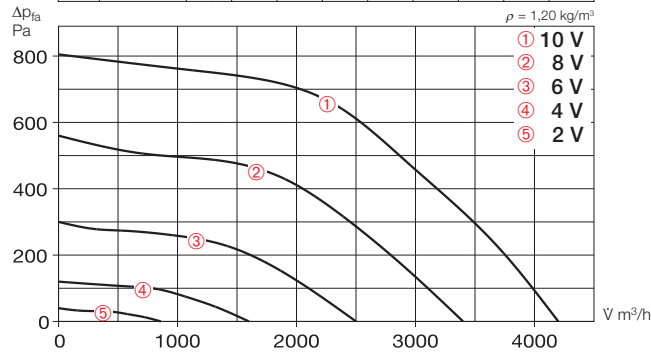

Free discharge						
Voltage V	n min ⁻¹	Ṃ m³/h	P W	I A	Lp dB(A)	SFP kW/m²/s
10	2200	4200	600	2,90	51	0,51
8	1800	3400	350	1,70	46	0,37
6	1300	2500	150	0,71	40	0,22
4	850	1600	60	0,34	33	0,14

SKRD EC 400/60/35

Frequency	Hz	Total	125	250	500	1k	2k	4k	8k
L _{WA} Case breakout		dB(A) 71	59	70	62	53	48	44	41
L _{WA} Intake		dB(A) 78	73	75	69	63	58	55	52
L _{WA} Exhaust		dB(A) 86	75	84	76	77	73	68	66

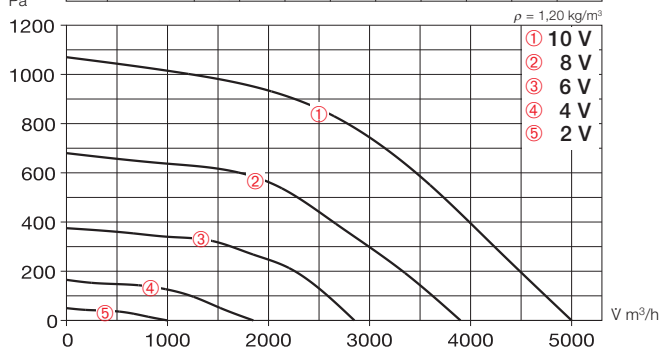

Free discharge						
Voltage V	n min ⁻¹	Ṃ m³/h	P W	I A	Lp dB(A)	SFP kW/m²/s
10	2500	5000	830	1,30	51	0,60
8	2000	3900	450	0,77	46	0,42
6	1450	2850	200	0,43	40	0,25
4	950	1850	70	0,25	33	0,14

Accessories

Gravity shutter

Type VK 60/35 Ref. no. 0878
Air stream operated louvres, light grey polymer.



External louver

Type WSG 60/35 Ref. no. 0113
Heavy duty construction made from profile anodised aluminium extrusion.



Vol. control damper for ducting

Type JVK 60/35 Ref. no. 6914
Casing with flanges on both sides. The control mechanism is outside the airstream. For electrical drive, see STM, accessory.



Circular spigot

Type FSK 60/35 Ref. no. 0835
For cost effective adaption of rectangular fans into circular ducting systems with Ø 355 mm.



Flexible connectors

Type VS 60/35 Ref. no. 5698
Flexible in-duct connector with flanges on both sides.



Counterflange

Type GF 60/35 Ref. no. 6923
Flange frames made of galvanised steel for connection to ducting.



Rectangular attenuator

Type KSD 60/30-35 No. 8730
For in-duct installation on intake or exhaust side.



Air-duct filter

Type KLF 60/30-35 G4 No. 8722
Type KLF 60/30-35 F7 No. 8646
Bag filter with a large cross section area. Galvanised steel casing with flanges on both sides.



Electric heater battery

Type EHR-K 15/60/30-35 No. 8706
Type EHR-K 30/60/30-35 No. 8707
Heating elements enclosed in a galvanised steel casing with connecting flanges on both sides.

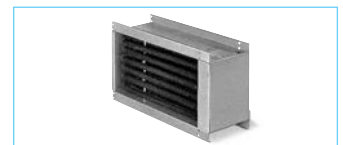

Temperature control system for electric heater battery

Type EHS 16 Ref. no. 5003



Warm water heater battery

Type WHR 2/60/30-35 No. 8786
Type WHR 4/60/30-35 No. 8787
For in-duct installation.

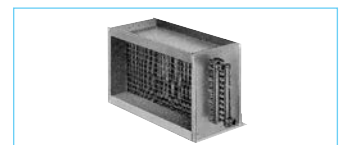

Temperature control system for warm water heater battery

Type WHS HE¹⁾ Ref. no. 8319

¹⁾ In model WHR 4/60/30-35 the heat output is reduced to 2200 l/h.



KR EC

Suitable for polluted air.



(Fig. similar)

Dim. in mm

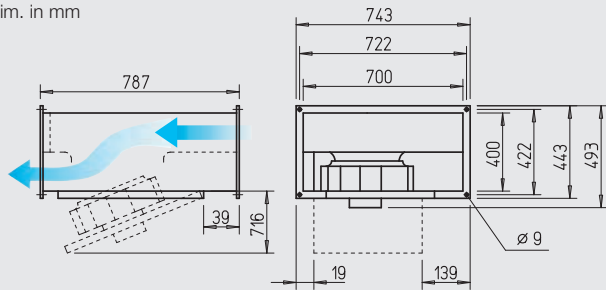

SKR EC – Sound insulated



Lowest sound levels for intake and case breakout at higher power density.

Use in extract and fresh air systems with specific requirements for low noise levels.



Dim. in mm

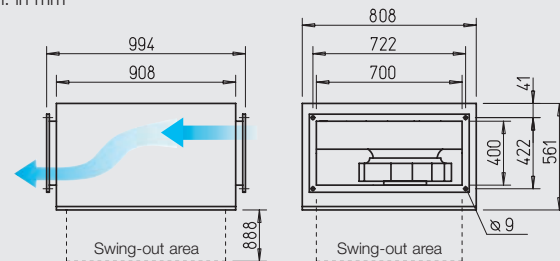

- **Features of KR EC and SKR EC**
 - Highly efficient EC-motor for lowest operating costs.
 - High pressure and high volume with high efficiency centrifugal fan.
 - Particularly easy to service (cleaning) thanks to the swing-out motor impeller unit.
 - For cleaning, easy access and therefore suitable for extraction of polluted air.
 - Straight through-flow.
 - Compact design, convenient installation.
- **Special features of SKR EC**
 - Lowest sound levels for intake and case breakout at higher power density.

- **Specification**
 - **Casing KR EC**
Made of galvanised steel. Flanged (20 mm) on both ends for in-duct installation.
 - **Casing SKR EC**
As above, but with additional sound insulation with 50 mm thick mineral fibre board, inside lined with a sound deadening perforated plate.
- **Common features of KR EC and SKR EC**
 - **Impeller**
Centrifugal, backward curved impeller made of polymer. Aerodynamically optimised, intake air flow by means of an inlet nozzle.

- **Motor**
Energy-saving, speed controllable EC-external rotor motors with highest efficiency, protection to IP 44 (SKR EC IP 54). With ball bearings, maintenance-free and interference-free. Motor and impeller are dynamically balanced.
- **Motor protection**
Integrated electronic temperature monitoring for EC-motor and electronics.
- **Speed control**
Stepless speed control with potentiometer or stepless speed control with universal control system (see table). Duties at different speeds are exemplarily given in the performance curve.

- **Electrical connection**
Terminal box (IP 54) fitted to flying lead.
- **Installation**
Installation in any position. Allowance must be made for the motor swing out access.
- **Sound levels**
Total sound power levels and the spectrum figures in dB(A) are given for:
 - Sound level case breakout
 - Sound level intake
 - Sound level exhaust
 In the table below as well as underneath the performance curve you can find additionally the sound pressure level at 4 m (free field conditions).

Type	Ref. no.	Air flow volume (FID)	Nominal R.P.M.	Sound press. case breakout	Motor power	Current	Wiring diagram	max. air flow temperature	Weight net approx.	Universal control system		Speed-potentiometer flush		Speed-potentiometer surface	
										Type	Ref. no.	Type	Ref. no.	Type	Ref. no.
Single Phase, 230 V, 50/60 Hz, EC motor, protection to IP 54															
KRW EC 450/70/40	6127	5450	1420	46	0.72	3.29	982	60	40.0	EUR EC ¹⁾²⁾	1347	PU 10 ¹⁾	1734	PA 10 ¹⁾	1735
Three Phase, 400 V, 50/60 Hz, EC motor, protection to IP 54															
KRD EC 450/70/40	8173	7480	2300	54	1.50	2.30	1005	60	40.0	EUR EC ¹⁾²⁾	1347	PU 10 ¹⁾	1734	PA 10 ¹⁾	1735
Sound insulated model SKR EC – 1-phase, 230 V, 50/60 Hz, EC motor, protection to IP 54															
SKRW EC 450/70/40 ³⁾	6129	5420	1410	45	0.71	3.24	982	60	60.0	EUR EC ¹⁾²⁾	1347	PU 10 ¹⁾	1734	PA 10 ¹⁾	1735
Sound insulated model SKR EC – 3-phase, 400 V, 50/60 Hz, EC motor, protection to IP 54															
SKRD EC 450/70/40 A	8178	7500	1800	51	1.44	2.24	1005	60	60.0	EUR EC ¹⁾²⁾	1347	PU 10 ¹⁾	1734	PA 10 ¹⁾	1735

1) Multiple EC fans can normally be connected 2) alternative electronic differential pressure/temp. controller (EDR/ETR, No. 1437/1438) or three-step speed controller (SU/SA, No. 4266/4267), s. accessories 3) Characteristic curve diagram on www.HeliosSelect.de

KRW EC 450/70/40

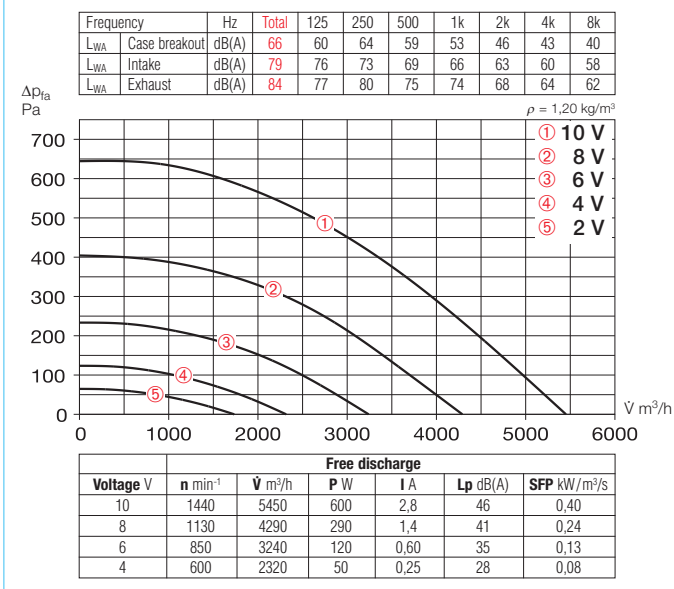

KRD EC 450/70/40

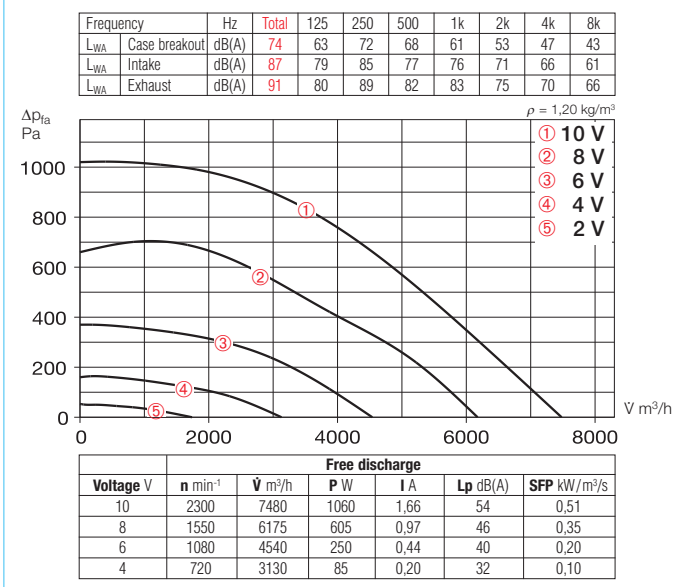

SKRD EC 450/70/40 A

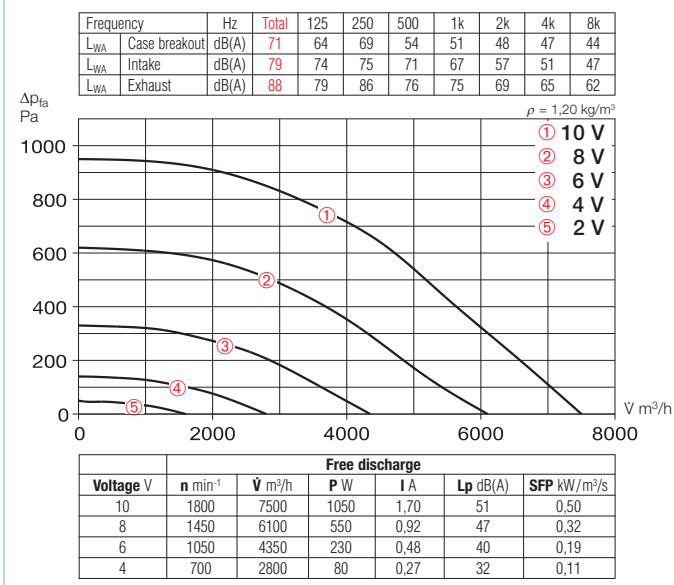

Accessories

Gravity shutter

Type VK 70/40 Ref. no. 0879

Air stream operated louvres, light grey polymer.



External louver

Type WSG 70/40 Ref. no. 0114

Heavy duty construction made from profile anodised aluminium extrusion.



Vol. control damper for ducting

Type JVK 70/40 Ref. no. 6915

Casing with flanges on both sides. The control mechanism is outside the airstream. For electrical drive, see STM, accessory.



Circular spigot

Type FSK 70/40 Ref. no. 0840

For cost effective adaption of rectangular fans into circular ducting systems with Ø 400 mm.



Flexible connectors

Type VS 70/40 Ref. no. 5699

Flexible in-duct connector with flanges on both sides.



Counterflange

Type GF 70/40 Ref. no. 6924

Flange frames made of galvanised steel for connection to ducting.



Rectangular attenuator

Type KSD 70/40 Ref. no. 8731

For in-duct installation on intake or exhaust side.



Air-duct filter

Type KLF 70/40 G4 No. 8723

Type KLF 70/40 F7 No. 8647

Bag filter with a large cross section area. Galvanised steel casing with flanges on both sides.



Warm water heater battery

Type WHR 2/70/40 No. 8788

Type WHR 4/70/40 No. 8789

For in-duct installation.

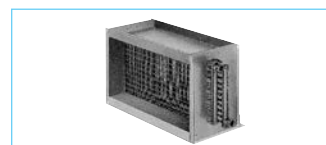

Temperature control system for warm water heater battery

Type WHS HE¹⁾ Ref. no. 8319

¹⁾ In model WHR 4/70/40 the heat output is reduced to 2200 l/h.



Accessory details Page

Shutters, grilles and louvres	420, 487 on
Filters, heater batteries and attenuators	421 on
Temperature control systems for heater batteries	427, 432 on
Universal control system, electronic controller, speed-potentiometer	539 on

KR EC

Suitable for polluted air.



(Fig. similar)

Dim. in mm

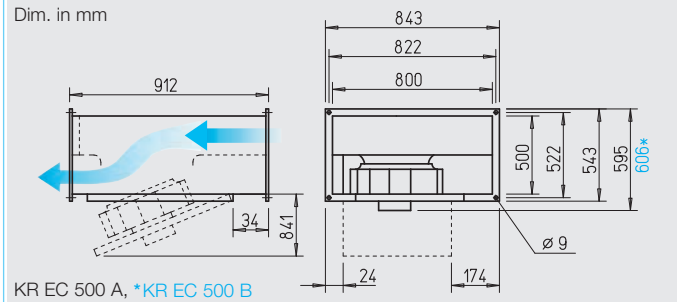

KR EC 500 A, *KR EC 500 B

SKR EC – Sound insulated



Lowest sound levels for intake and case breakout at higher power density.

Use in extract and fresh air systems with specific requirements for low noise levels.



Dim. in mm

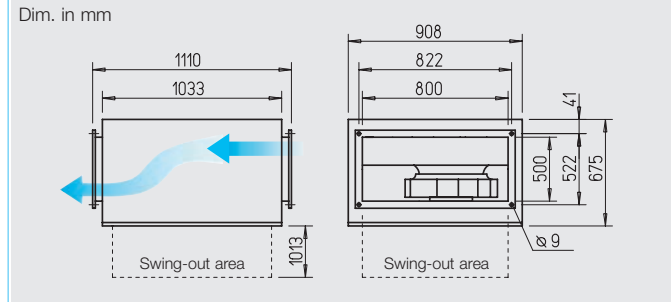

- **Features of KR EC and SKR EC**
 - Highly efficient EC-motor for lowest operating costs.
 - High pressure and high volume with high efficiency centrifugal fan.
 - Particularly easy to service (cleaning) thanks to the swing-out motor impeller unit.
 - For cleaning, easy access and therefore suitable for extraction of polluted air.
 - Straight through-flow.
 - Compact design, convenient installation.
- **Special features of SKR EC**
 - Lowest sound levels for intake and case breakout at higher power density.

- **Specification**
 - **Casing KR EC**
Made of galvanised steel. Flanged (20 mm) on both ends for in-duct installation.
 - **Casing SKR EC**
As above, but with additional sound insulation with 50 mm thick mineral fibre board, inside lined with a sound deadening perforated plate.
- **Common features of KR EC and SKR EC**
 - **Impeller**
Centrifugal, backward curved impeller made of polymer. Aerodynamically optimised, intake air flow by means of an inlet nozzle.

- **Motor**
Energy-saving, speed controllable EC-external rotor motors with highest efficiency, protection to IP 44 (SKR EC IP 54). With ball bearings, maintenance-free and interference-free. Motor and impeller are dynamically balanced.
- **Motor protection**
Integrated electronic temperature monitoring for EC-motor and electronics.
- **Speed control**
Stepless speed control with potentiometer or stepless speed control with universal control system (see table). Duties at different speeds are exemplarily given in the performance curve.

- **Electrical connection**
Terminal box (IP 54) fitted to flying lead.
- **Installation**
Installation in any position. Allowance must be made for the motor swing out access.
- **Sound levels**
Total sound power levels and the spectrum figures in dB(A) are given for:
 - Sound level case breakout
 - Sound level intake
 - Sound level exhaust
 In the table below as well as underneath the performance curve you can find additionally the sound pressure level at 4 m (free field conditions).

Type	Ref. no.	Air flow volume (FID)	Nominal R.P.M.	Sound press. case breakout	Motor power	Current	Wiring diagram	max. air flow temperature	Weight net approx.	Universal control system		Speed-potentiometer flush		Speed-potentiometer surface	
										Type	Ref. no.	Type	Ref. no.	Type	Ref. no.
Three phase, 400 V, 50/60 Hz, EC motor, protection to IP 54															
KRD EC 500/80/50 A	8174	8810	1400	51	1.26	1.96	1005	60	55.6	EUR EC ¹⁾²⁾	1347	PU 10 ¹⁾	1734	PA 10 ¹⁾	1735
KRD EC 500/80/50 B ³⁾	6128	10400	1800	60	2.57	3.92	1005	60	55.0	EUR EC ¹⁾²⁾	1347	PU 10 ¹⁾	1734	PA 10 ¹⁾	1735
Sound insulated model SKR EC – 3-phase, 400 V, 50/60 Hz, EC motor, protection to IP 54															
SKRD EC 500/80/50 A	8299	8600	1400	48	1.20	1.87	1005	60	67.5	EUR EC ¹⁾²⁾	1347	PU 10 ¹⁾	1734	PA 10 ¹⁾	1735
SKRD EC 500/80/50 B	8179	10650	1800	55	2.42	3.68	1005	60	79.5	EUR EC ¹⁾²⁾	1347	PU 10 ¹⁾	1734	PA 10 ¹⁾	1735

1) Multiple EC fans can normally be connected 2) alternative electronic differential pressure/temp. controller (EDR/ETR, No. 1437/1438) or three-step speed controller (SU/SA, No. 4266/4267), s. accessories
3) Characteristic curve diagram on www.HeliosSelect.de

KRD EC 500/80/50 A

Frequency	Hz	Total	125	250	500	1k	2k	4k	8k
L _{WA} Case breakout	dB(A)	71	68	66	62	56	48	42	45
L _{WA} Intake	dB(A)	82	79	73	70	72	70	67	67
L _{WA} Exhaust	dB(A)	86	81	81	78	78	74	71	70

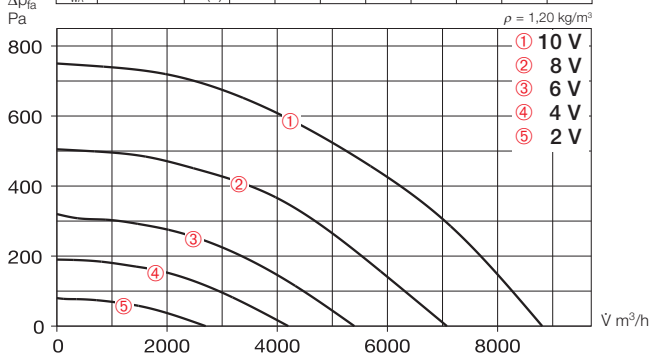

Free discharge						
Voltage V	n min ⁻¹	Ṃ m³/h	P W	I A	Lp dB(A)	SFP kW/m²/s
10	1400	8810	800	1,3	51	0,33
8	1150	7080	455	0,76	47	0,23
6	900	5400	230	0,44	41	0,15
4	700	4200	120	0,31	34	0,10

SKRD EC 500/80/50 A

Frequency	Hz	Total	125	250	500	1k	2k	4k	8k
L _{WA} Case breakout	dB(A)	68	67	60	52	52	48	43	38
L _{WA} Intake	dB(A)	76	76	64	58	56	54	50	51
L _{WA} Exhaust	dB(A)	83	79	76	72	73	67	66	66

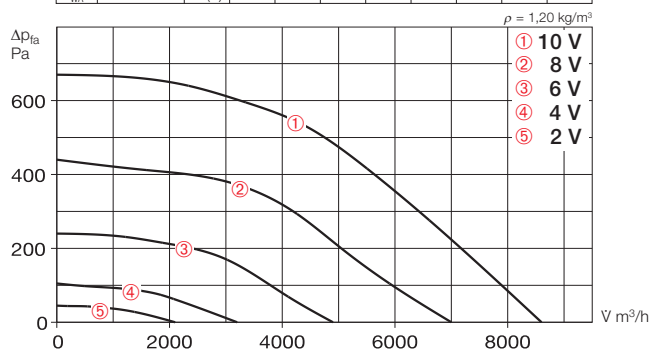

Free discharge						
Voltage V	n min ⁻¹	Ṃ m³/h	P W	I A	Lp dB(A)	SFP kW/m²/s
10	1400	8600	780	1,30	48	0,33
8	1150	7000	400	0,72	44	0,21
6	850	4900	180	0,41	38	0,13
4	530	3200	60	0,26	32	0,10

SKRD EC 500/80/50 B

Frequency	Hz	Total	125	250	500	1k	2k	4k	8k
L _{WA} Case breakout	dB(A)	75	69	73	59	58	57	54	51
L _{WA} Intake	dB(A)	81	75	78	68	65	62	57	59
L _{WA} Exhaust	dB(A)	90	82	87	81	82	75	73	73

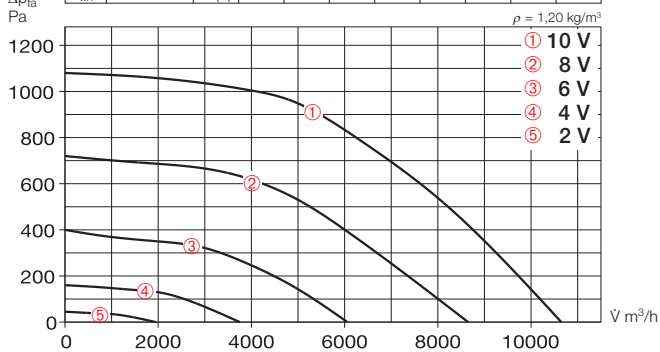

Free discharge						
Voltage V	n min ⁻¹	Ṃ m³/h	P W	I A	Lp dB(A)	SFP kW/m²/s
10	1800	10650	1750	2,70	55	0,59
8	1450	8650	950	1,50	50	0,40
6	1050	6060	400	0,68	43	0,24
4	700	3750	130	0,34	35	0,13

Accessories

Gravity shutter

Type VK 80/50 Ref. no. 0880

Air stream operated louvres, light grey polymer.



External louvre

Type WSG 80/50 Ref. no. 0115

Heavy duty construction made from profile anodised aluminium extrusion.



Vol. control damper for ducting

Type JVK 80/50 Ref. no. 6916

Casing with flanges on both sides. The control mechanism is outside the airstream. For electrical drive, see STM, accessory.



Circular spigot

Type FSK 80/50 Ref. no. 0842

For cost effective adaption of rectangular fans into circular ducting systems with Ø 500 mm.



Flexible connectors

Type VS 80/50 Ref. no. 5700

Flexible in-duct connector with flanges on both sides.



Counterflange

Type GF 80/50 Ref. no. 6925

Flange frames made of galvanised steel for connection to ducting.



Rectangular attenuator

Type KSD 80/50 Ref. no. 8732

For in-duct installation on intake or exhaust side.



Air-duct filter

Type KLF 80/50 G4 No. 8670

Type KLF 80/50 F7 No. 8654

Bag filter with a large cross section area. Galvanised steel casing with flanges on both sides.



Warm water heater battery

Type WHR 2/80/50 No. 8795

Type WHR 4/80/50 No. 8796

For in-duct installation.

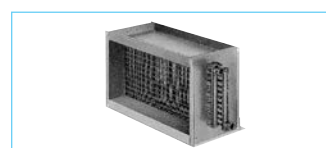

Accessory details Page

Accessory details	Page
Shutters, grilles and louvres	420, 487 on
Filters, heater batteries and attenuators	421 on
Universal control system, electronic controller, speed-potentiometer	539 on

KR EC

Suitable for polluted air.



(Fig. similar)

Dim. in mm

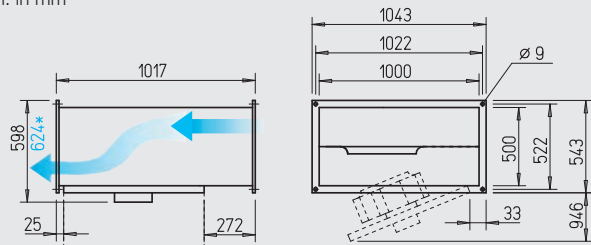

KR EC 560 A, *KR EC 560 B

SKR EC – Sound insulated



Lowest sound levels for intake and case breakout at higher power density.

Use in extract and fresh air systems with specific requirements for low noise levels.



Dim. in mm

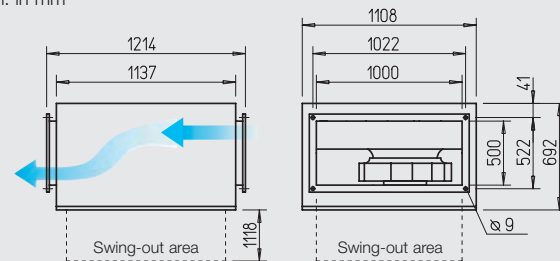

- **Features of KR EC and SKR EC**
 - Highly efficient EC-motor for lowest operating costs.
 - High pressure and high volume with high efficiency centrifugal fan.
 - Particularly easy to service (cleaning) thanks to the swing-out motor impeller unit.
 - For cleaning, easy access and therefore suitable for extraction of polluted air.
 - Straight through-flow.
 - Compact design, convenient installation.
- **Special features of SKR EC**
 - Lowest sound levels for intake and case breakout at higher power density.

- **Specification**
 - **Casing KR EC**
Made of galvanised steel. Flanged (20 mm) on both ends for in-duct installation.
 - **Casing SKR EC**
As above, but with additional sound insulation with 50 mm thick mineral fibre board, inside lined with a sound deadening perforated plate.
- **Common features of KR EC and SKR EC**
 - **Impeller**
Centrifugal, backward curved impeller made of polymer. Aerodynamically optimised, intake air flow by means of an inlet nozzle.

- **Motor**
Energy-saving, speed controllable EC-external rotor motors with highest efficiency, protection to IP 44 (SKR EC IP 54). With ball bearings, maintenance-free and interference-free. Motor and impeller are dynamically balanced.
- **Motor protection**
Integrated electronic temperature monitoring for EC-motor and electronics.
- **Speed control**
Stepless speed control with potentiometer or stepless speed control with universal control system (see table). Duties at different speeds are exemplarily given in the performance curve.

- **Electrical connection**
Terminal box (IP 54) fitted to flying lead.
- **Installation**
Installation in any position. Allowance must be made for the motor swing out access.
- **Sound levels**
Total sound power levels and the spectrum figures in dB(A) are given for:
 - Sound level case breakout
 - Sound level intake
 - Sound level exhaust
 In the table below as well as underneath the performance curve you can find additionally the sound pressure level at 4 m (free field conditions).

Type	Ref. no.	Air flow volume (FID)	Nominal R.P.M.	Sound press. case breakout	Motor power	Current	Wiring diagram	max. air flow temperature	Weight net approx.	Universal control system		Speed-potentiometer flush		Speed-potentiometer surface	
										Type	Ref. no.	Type	Ref. no.	Type	Ref. no.
Three phase, 400 V, 50/60 Hz, EC motor, protection to IP 54															
KRD EC 560/100/50 A	8167	11270	1230	54	1.57	2.45	1005	60	70.8	EUR EC ⁽¹⁾²⁾	1347	PU 10 ⁽¹⁾	1734	PA 10 ⁽¹⁾	1735
KRD EC 560/100/50 B	8175	14410	1630	60	3.45	5.20	1005	60	83.0	EUR EC ⁽¹⁾²⁾	1347	PU 10 ⁽¹⁾	1734	PA 10 ⁽¹⁾	1735
Sound insulated model SKR EC – 3-phase, 400 V, 50/60 Hz, EC motor, protection to IP 54															
SKRD EC 560/100/50 A ³⁾	6130	10070	1230	48	1.48	2.30	1005	60	98.0	EUR EC ⁽¹⁾²⁾	1347	PU 10 ⁽¹⁾	1734	PA 10 ⁽¹⁾	1735
SKRD EC 560/100/50 B	8180	13700	1630	56	3.26	4.98	1005	60	100.0	EUR EC ⁽¹⁾²⁾	1347	PU 10 ⁽¹⁾	1734	PA 10 ⁽¹⁾	1735

1) Multiple EC fans can normally be connected 2) alternative electronic differential pressure/temp. controller (EDR/ETR, No. 1437/1438) or three-step speed controller (SU/SA, No. 4266/4267), s. accessories
3) Characteristic curve diagram on www.HeliosSelect.de

KRD EC 560/100/50 A

Frequency	Hz	Total	125	250	500	1k	2k	4k	8k
L _{WA} Case breakout	dB(A)	74	71	69	63	57	51	47	48
L _{WA} Intake	dB(A)	82	79	73	71	73	70	66	66
L _{WA} Exhaust	dB(A)	88	82	82	79	79	75	71	72

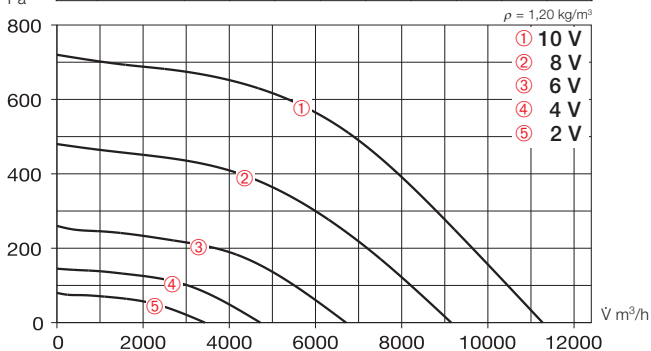

Free discharge						
Voltage V	n min ⁻¹	V̇ m³/h	P W	I A	Lp dB(A)	SFP kW/m²/s
10	1230	11270	950	1,50	54	0,30
8	1000	9150	500	0,85	50	0,20
6	730	6710	210	0,40	43	0,12
4	550	4720	100	0,24	37	0,08

KRD EC 560/100/50 B

Frequency	Hz	Total	125	250	500	1k	2k	4k	8k
L _{WA} Case breakout	dB(A)	80	74	77	73	68	60	56	50
L _{WA} Intake	dB(A)	89	84	82	81	81	78	74	69
L _{WA} Exhaust	dB(A)	96	89	91	87	88	84	80	74

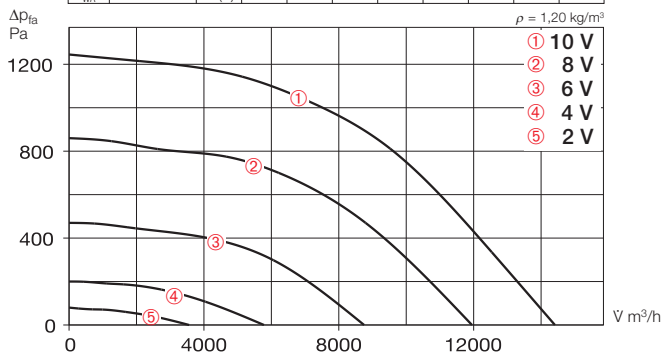

Free discharge						
Voltage V	n min ⁻¹	V̇ m³/h	P W	I A	Lp dB(A)	SFP kW/m²/s
10	1630	14410	2270	3,45	60	0,57
8	1350	11950	1300	2,00	56	0,39
6	1000	8750	580	0,91	50	0,24
4	650	5780	170	0,30	41	0,11

SKRD EC 560/100/50 B

Frequency	Hz	Total	125	250	500	1k	2k	4k	8k
L _{WA} Case breakout	dB(A)	76	73	71	62	57	56	54	48
L _{WA} Intake	dB(A)	80	77	73	70	67	63	60	56
L _{WA} Exhaust	dB(A)	90	85	84	81	82	75	72	68

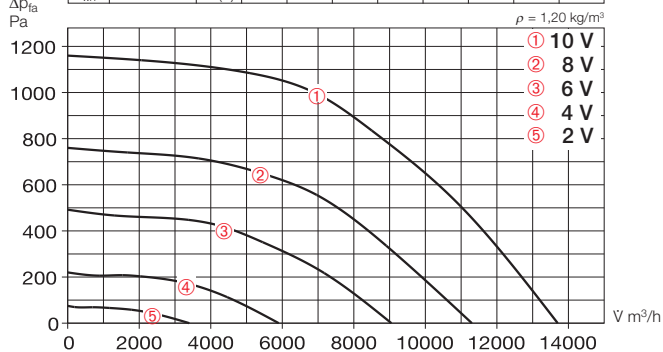

Free discharge						
Voltage V	n min ⁻¹	V̇ m³/h	P W	I A	Lp dB(A)	SFP kW/m²/s
10	1630	13700	2370	3,60	56	0,62
8	1300	11300	1250	1,90	51	0,40
6	1050	9050	680	1,10	47	0,27
4	700	5900	250	0,51	39	0,15

Accessories

Gravity shutter

Type VK 100/50 Ref. no. 0881

Air stream operated louvres, light grey polymer.



External louvre

Type WSG 100/50 Ref. no. 0116

Heavy duty construction made from profile anodised aluminium extrusion.



Vol. control damper for ducting

Type JVK 100/50 Ref. no. 6917

Casing with flanges on both sides. The control mechanism is outside the airstream. For electrical drive, see STM, accessory.



Circular spigot

Type FSK 100/50 Ref. no. 0843

For cost effective adaption of rectangular fans into circular ducting systems with Ø 500 mm.



Flexible connectors

Type VS 100/50 Ref. no. 5701

Flexible in-duct connector with flanges on both sides.

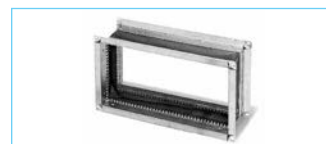

Counterflange

Type GF 100/50 Ref. no. 6926

Flange frames made of galvanised steel for connection to ducting.



Rectangular attenuator

Type KSD 100/50 Ref. no. 8733

For in-duct installation on intake or exhaust side.



Air-duct filter

Type KLF 100/50 G4 No. 8671

Type KLF 100/50 F7 No. 8655

Bag filter with a large cross section area. Galvanised steel casing with flanges on both sides.



Warm water heater battery

Type WHR 2/100/50 No. 8797

Type WHR 4/100/50 No. 8798

For in-duct installation.

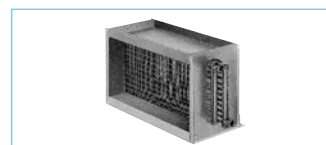

Accessory details Page

Shutters, grilles and louvres	420, 487 on
Filters, heater batteries and attenuators	421 on
Universal control system, electronic controller, speed-potentiometer	539 on

KR 180

Suitable for polluted air.



Dim. in mm

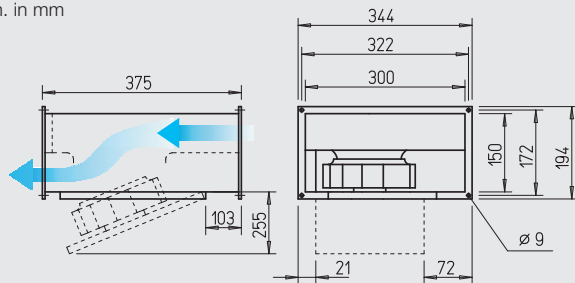

KR 225

Suitable for polluted air.



Dim. in mm

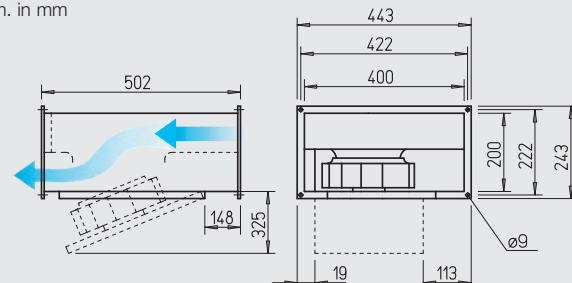

Rectangular EC centrifugal fan with backward curved impeller and swing-out motor impeller unit.

- Highly efficient high performance impellers.
- Use in extract and fresh air systems for conveying higher air flow volume.
- Suitable for extraction of polluted air.
- **Special features**
 - High pressure and high volume specific centrifugal fan with high efficiency.
 - Particularly easy to service (cleaning) thanks to the swing-out motor impeller unit.
 - For cleaning, easy access and therefore suitable for extraction of polluted air.
 - For cleaning, easy access and therefore suitable for extraction of polluted air.

■ **Specification**

- **Casing**
Made of galvanised steel. Flanged (20 mm) on both ends for in-duct installation.
- **Impeller**
Centrifugal, backward curved impeller made of polymer. Aerodynamically optimised, intake air flow by means of an inlet nozzle.
- **Motor**
Energy saving, speed controllable EC-external rotor motors with highest efficiency, protection to IP 44. With ball bearings, maintenance-free and interference-free. Motor and impeller are dynamically balanced.

□ **Motor protection**

Automatic resetting through built-in thermal contacts with winding connected in series.

□ **Speed control**

Stepless speed control with potentiometer or stepless speed control with universal control system (see table). Duties at different speeds are exemplarily given in the performance curve.

□ **Electrical connection**

Terminal box (IP 54) fitted to flying lead.

□ **Installation**

Installation in any position. Allowance must be made for the motor swing out access.

□ **Sound Levels**

Above the performance curve, total values and spectrum are given for:

- Sound level case breakout
- Sound level intake
- Sound level exhaust

The sound power level (on intake) is additionally shown within the performance curve for corresponding control voltages. In the table below you can also find:

- Case breakout sound level at 4 m (free field conditions).

Note	Page
Selection chart	372
Technical description	373
Design guidelines	10 on
Modul. system components	370

Type	Ref. no.	Air flow volume (FID) V m³/h	Nominal R.P.M. min⁻¹	Sound press. case breakout dB(A) in 4 m	Motor power		Wiring diagram No.	max. air flow temperature at full load		Weight net approx. kg	Speed controller					
					kW	A		+°C	+°C		5-step transformer		surface, electronic		flush, electronic	
											Type	Ref. no.	Type	Ref. no.	Type	Ref. no.
Single phase, capacitor motor, 230 V, 50 Hz, protection to IP 44																
KRW 180/2/30/15	8885	540	2460	37	0.06	0.35	508	70	70	5.5	TSW 1,5	1495	ESA 1	0238	ESU 1	0236
KRW 225/2/40/20	8886	1020	2530	40	0.12	0.46	508	70	70	9.8	TSW 1,5	1495	ESA 1	0238	ESU 1	0236

KRW 180/2/30/15

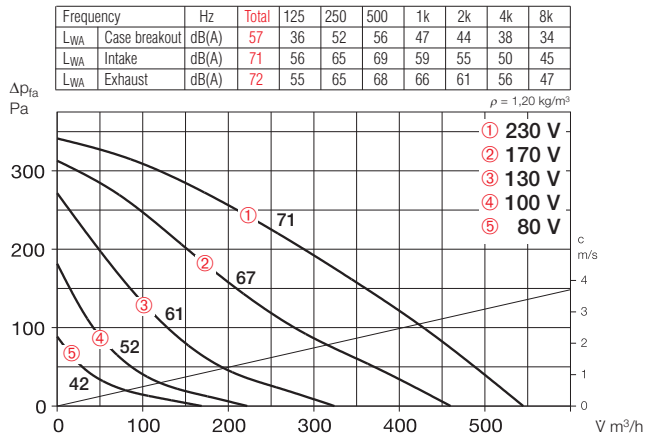

KRW 225/2/40/20

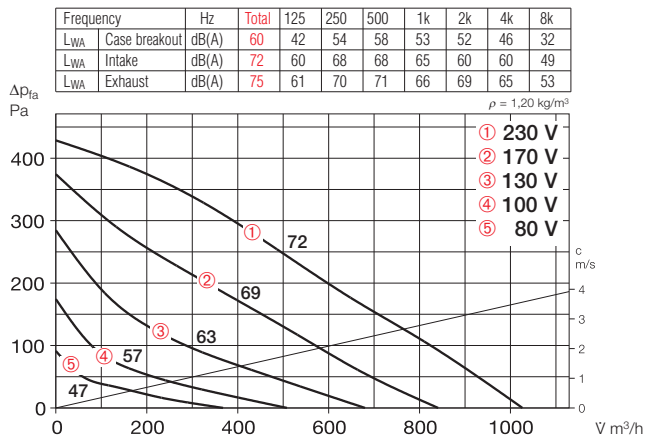

Accessory details Page

Shutters, grilles and louvres	420, 487
Filters, heater batteries and attenuators	421
Temperature control systems for heater batteries	427, 432
Speed controller and full motor protection devices	525

Accessories

Gravity shutter

Type VK 30/15 Ref. no. 0735

Type VK 40/20 Ref. no. 0874

Air stream operated louvres, light grey polymer.

External louvre

Type WSG 30/15 Ref. no. 0108

Type WSG 40/20 Ref. no. 0109

Heavy duty construction made from profile aluminium extrusion.

Vol. control damper for ducting

Type JVK 30/15 Ref. no. 6927

Type JVK 40/20 Ref. no. 6910

Casing with flanges on both sides. For electrical drive, see STM, accessory.

Circular spigot

Type FSK 30/15 Ref. no. 0831

Type FSK 40/20 Ref. no. 0832

For adaption of rectangular fans into circular ducting systems with Ø 160 or 200 mm.

Flexible connectors

Type VS 30/15 Ref. no. 6928

Type VS 40/20 Ref. no. 5694

Flexible in-duct connector with flanges on both sides.

Counterflange

Type GF 30/15 Ref. no. 6918

Type GF 40/20 Ref. no. 6919

Flange frames made of galvanised steel for connection to ducting.

Rectangular attenuator

Type KSD 40/20 Ref. no. 8728

For in-duct installation on intake or exhaust side.

Air-duct filter

Type KLF 40/20 G4 No. 8720

Type KLF 40/20 F7 No. 8644

Bag filter with a large cross section area. Galvanised steel casing with flanges on both sides.

Electric heater battery

Type EHR-K 6/40/20 No. 8702

Type EHR-K 15/40/20 No. 8703

Heating elements enclosed in a galvanised steel casing with connecting flanges on both sides.

Temperature control system for electric heater battery

Type EHSD 16 Ref. no. 5003

Warm water heater battery

Type WHR 2/40/20 No. 8782

Type WHR 4/40/20 No. 8783

For in-duct installation.

Temperature control system for warm water heater battery

Type WHS HE Ref. no. 8319

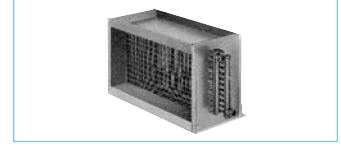
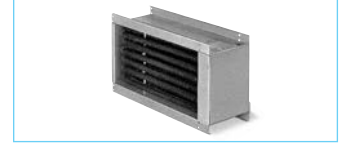
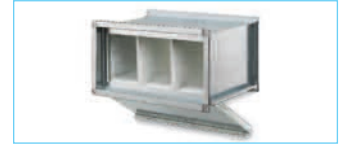
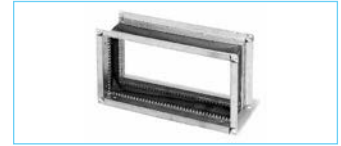

KR

Suitable for polluted air.



Dim. in mm

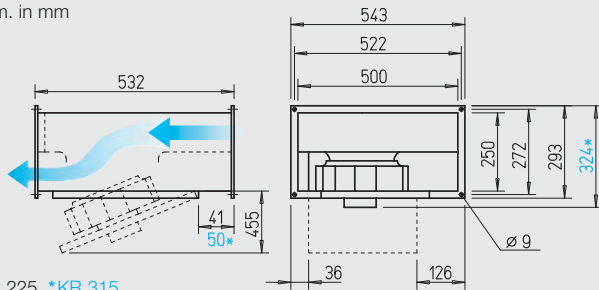

KR 225, *KR 315

■ **Features of KR and SKR**

- High pressure and high volume with high efficiency centrifugal fan.
- Particularly easy to service (cleaning) thanks to the swing-out motor impeller unit.
- For cleaning, easy access and therefore suitable for extraction of polluted air.
- Straight through-flow.
- Compact design, convenient installation.

■ **Special features of SKR**

- Lowest sound levels for intake and case breakout at higher power density.
- **Specification**
- Casing KR**
Made of galvanised steel. Flanged (20 mm) on both ends for in-duct installation.
- Casing SKR**
As above, but with additional sound insulation with 50 mm thick mineral fibre board, inside lined with a sound deadening perforated plate.

SKR – Sound insulated



Lowest sound levels for intake and case breakout at higher power density.

Use in extract and fresh air systems with specific requirements for low noise levels.



Dim. in mm

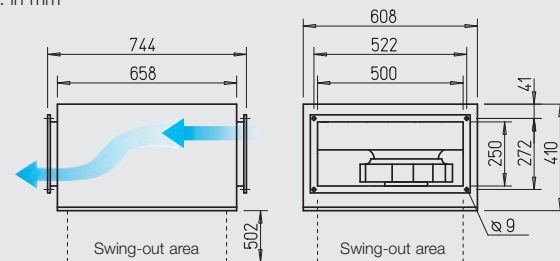

■ **Common features of KR and SKR**

- Impeller**
Centrifugal, backward curved impeller made of polymer. Aerodynamically optimised, intake air flow by means of an inlet nozzle.
- Motor**
Through maintenance-free external-rotor motor, on which the impeller is mounted. Closed design. Protection to IP 54 (KR 225 IP 33). Winding with moisture impregnation. Ball bearing mounted, interference-free. Motor and impeller are dynamically balanced.
- Motor protection**
Through built-in thermal contacts via a tripping unit (accessories). In case of KRW 225 through built-in therm. contacts, with winding connected in series, automatic resetting.

Speed control

possible through voltage reduction by means of 5-step transformer or electronic (stepless). Duties at different speeds are exemplarily given in the performance curve.

Electrical connection

Terminal box (IP 54) fitted to flying lead.

Installation

Installation in any position. Allowance must be made for the motor swing out access. (Exception: KRW 225 may only be installed with inspection flap facing downwards or to the side.)

Note	Page
Selection chart	372
Technical description	373
Design guidelines	10 on Modul. system components
	370

Type	Ref. no.	Air flow volume (FID) V m³/h	Nominal R.P.M. min⁻¹	Sound press. case breakout dB(A) in 4 m	Motor power		Wiring diagram No.	max. air flow temperature at full load		Weight net approx. kg	Speed controller					
					kW	A		+°C	+°C		5-step transformer		Full motor protection			
											Type	Ref. no.	Type	Ref. no.	Type	Ref. no.
Single phase, capacitor motor, 230 V, 50 Hz, protection to IP 33 (225), IP 54 (315)																
KRW 225/2/50/25	8873	1160	2680	45	0.17	0.73	508	70	60	15.0	TSW 1,5 ¹⁾	1495	ESA 1 ¹⁾	0238	ESU 1 ¹⁾	0236
KRW 315/4/50/25	6149	1760	1390	39	0.18	0.95	536.1	60	60	16.8	TSW 1,5 ¹⁾	1495	ESA 3 ¹⁾	0239	ESU 3 ¹⁾	0237
Sound insulated model SKR – Single phase, 230 V, 50 Hz, capacitor motor, protection to IP 54																
SKRW 315/4/50/25	6142	1770	1390	34	0.19	0.97	536.1	60	60	33.1	MWS 1,5	1947	MW		1579	

1) Full motor protection device required, Type MW, No. 1579, see accessories.

KRW 225/2/50/25

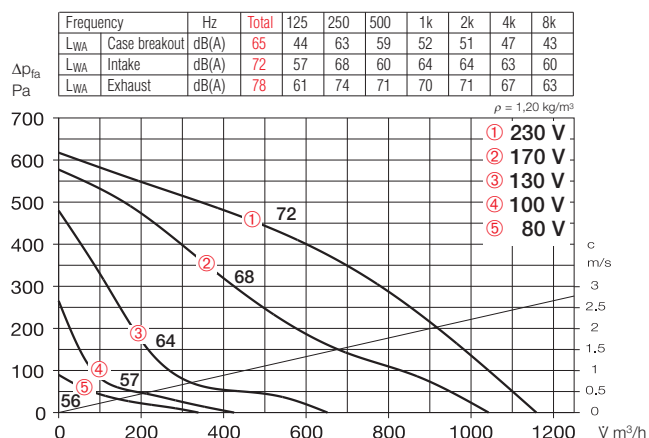

KRW 315/4/50/25

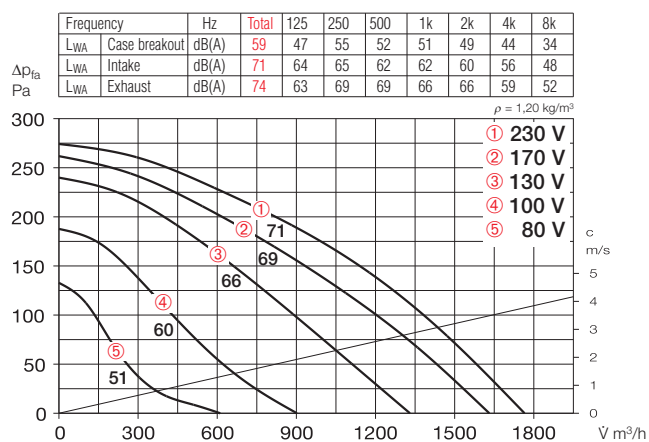

SKRW 315/4/50/25

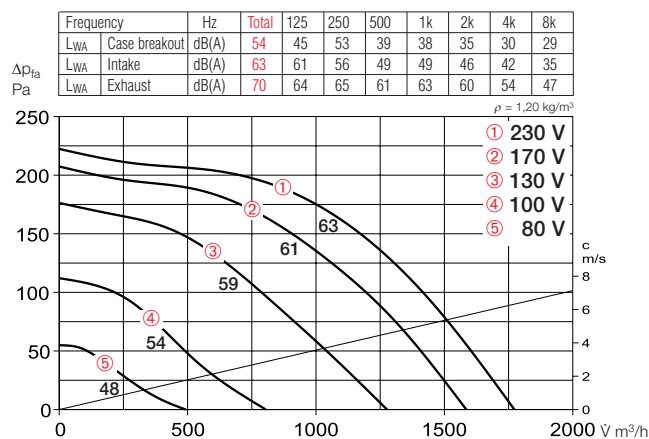

Sound Levels

Above the performance curve, total values and spectrum are given for:

- Sound level case breakout
- Sound level intake
- Sound level exhaust

The sound power level (on intake) is additionally shown within the performance curve for corresponding control voltages. In the table below you can also find:

- Case breakout sound level at 4 m (free field conditions).

Accessory details Page

Shutters, grilles and louvres	420, 487
Filters, heater batteries and attenuators	421
Temperature control systems for heater batteries	427, 432
Speed controller and full motor protection devices	525

Accessories

Gravity shutter

Type VK 50/25 Ref. no. 0875

Air stream operated louvres, light grey polymer.

External louver

Type WSG 50/25 Ref. no. 0110

Heavy duty construction made from profile anodised aluminium extrusion.

Vol. control damper for ducting

Type JVK 50/25 Ref. no. 6911

Casing with flanges on both sides. The control mechanism is outside the airstream. For electrical drive, see STM, accessory.

Circular spigot

Type FSK 50/25 Ref. no. 0833

For adaption of rectangular fans into circular ducting systems with Ø 250 mm.

Flexible connectors

Type VS 50/25 Ref. no. 5695

Flexible in-duct connector with flanges on both sides.

Counterflange

Type GF 50/25 Ref. no. 6920

Flange frames made of galvanised steel for connection to ducting.

Rectangular attenuator

Type KSD 50/25-30 No. 8729

For in-duct installation on intake or exhaust side.

Air-duct filter

Type KLF 50/25-30 G4 No. 8721

Type KLF 50/25-30 F7 No. 8645

Bag filter with a large cross section area. Galvanised steel casing with flanges on both sides.

Electric heater battery

Type EHR-K 8/50/25-30 No. 8704

Type EHR-K 24/50/25-30 No. 8705

Heating elements enclosed in a galvanised steel casing with connecting flanges on both sides.

Temperature control system for electric heater battery

Type EHSD 16 Ref. no. 5003

Warm water heater battery

Type WHR 2/50/25-30 No. 8784

Type WHR 4/50/25-30 No. 8785

For in-duct installation.

Temperature control system for warm water heater battery

Type WHS HE Ref. no. 8319

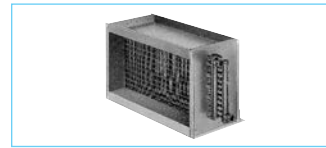
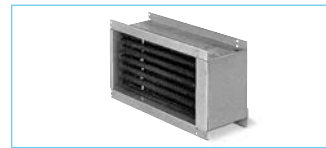

KR

Suitable for polluted air.



Dim. in mm

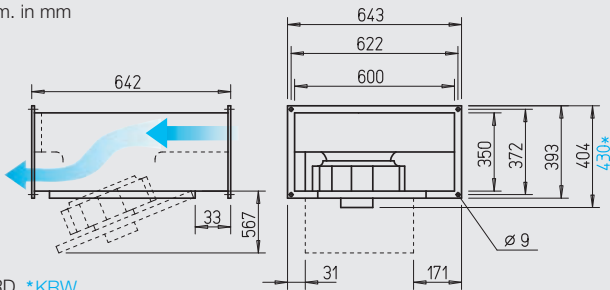

KRD, *KRW

■ **Features of KR and SKR**

- High pressure and high volume with high efficiency centrifugal fan.
- Particularly easy to service (cleaning) thanks to the swing-out motor impeller unit.
- For cleaning, easy access and therefore suitable for extraction of polluted air.
- Straight through-flow.
- Compact design, convenient installation.

■ **Special features of SKR**

- Lowest sound levels for intake and case breakout at higher power density.

■ **Specification**

- Casing KR**
Made of galvanised steel. Flanged (20 mm) on both ends for in-duct installation.

- Casing SKR**
As above, but with additional sound insulation with 50 mm thick mineral fibre board, inside lined with a sound deadening perforated plate.

■ **Common features of KR and SKR**

- Impeller**
Centrifugal, backward curved impeller made of polymer. Aerodynamically optimised, intake air flow by means of an inlet nozzle.

SKR – Sound insulated



Lowest sound levels for intake and case breakout at higher power density.

Use in extract and fresh air systems with specific requirements for low noise levels.



Dim. in mm

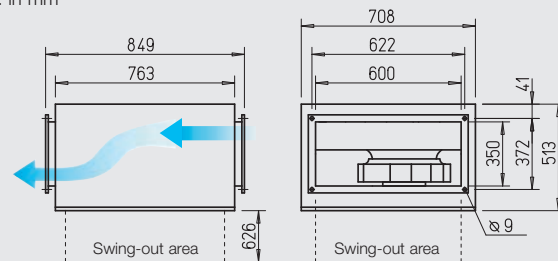

Motor

Through maintenance-free external-rotor motor, on which the impeller is mounted. Closed design. Protection to IP 54. Winding with moisture impregnation. Ball bearing mounted, interference-free. Motor and impeller are dynamically balanced.

Motor protection

Through built-in thermal contacts via a tripping unit (accessories).

Speed control

possible through voltage reduction by means of 5-step transformer or electronic (stepless). Duties at different speeds are exemplarily given in the performance curve.

Electrical connection

Terminal box (IP 54) fitted to flying lead.

Installation

Installation in any position. Allowance must be made for the motor swing out access.

Sound Levels

Above the performance curve, total values and spectrum are given for:

- Sound level case breakout
- Sound level intake
- Sound level exhaust

The sound power level (on intake) is additionally shown within the performance curve for corresponding control voltages. In the table below you can also find:

- Case breakout sound level at 4 m (free field conditions).

Type	Ref. no.	Air flow volume (FID)	Nominal R.P.M.	Sound press. case breakout	Motor power		Wiring diagram No.	max. air flow temperature at full load control		Weight net approx. kg	Speed controller 5-step with full motor protection		Full motor protection device for connection of built-in thermal contacts		
		V m³/h	min⁻¹	dB(A) in 4 m	kW	A		+°C	+°C		Type	Ref. no.	Type	Ref. no.	
Single phase, 230 V, 50 Hz, capacitor motor, protection to IP 54															
KRW 355/4/60/35	8692	3600	1390	42	0.37	1.90	536.1	60	60	28.4	MWS 3	1948	MW	1579	
Three phase, 230/400 V, 50 Hz, protection to IP 54															
KRD 355/4/60/35	8584	2840	1330	37	0.25	0.80/0.46	860	60	60	27.2	RDS 1	1314	MD	5849	
Sound insulated model SKR – Single phase motor, 230 V, 50 Hz, capacitor motor, protection to IP 54															
SKRW 355/4/60/35	8681	3580	1400	39	0.35	1.82	536.1	60	60	48.8	MWS 3	1948	MW	1579	
Sound insulated model SKR – Three phase motor, 230/400 V, 50 Hz, protection to IP 54															
SKRD 355/4/60/35	8181	2800	1330	34	0.24	0.78/0.45	860	60	60	49.0	RDS 1	1314	MD	5849	

KRW 355/4/60/35

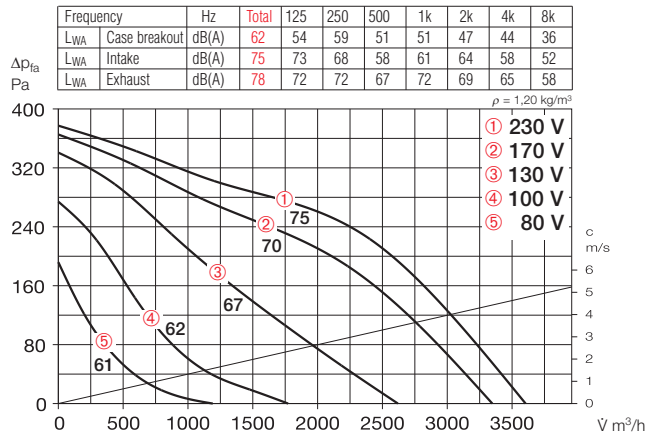

KRD 355/4/60/35

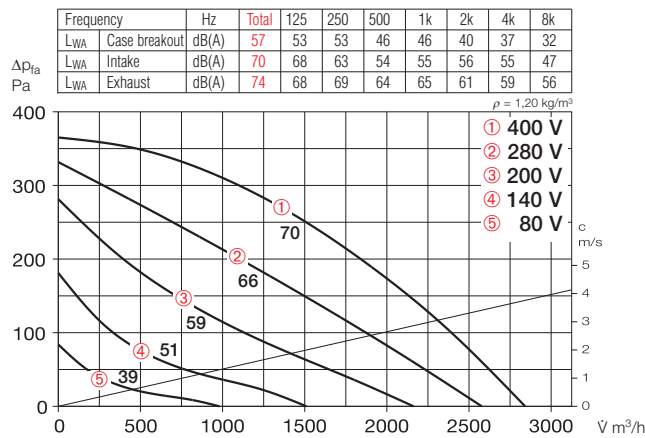

SKRW 355/4/60/35

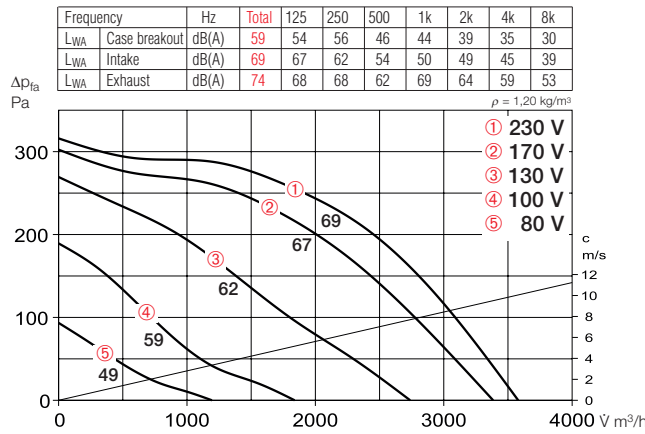

SKRD 355/4/60/35

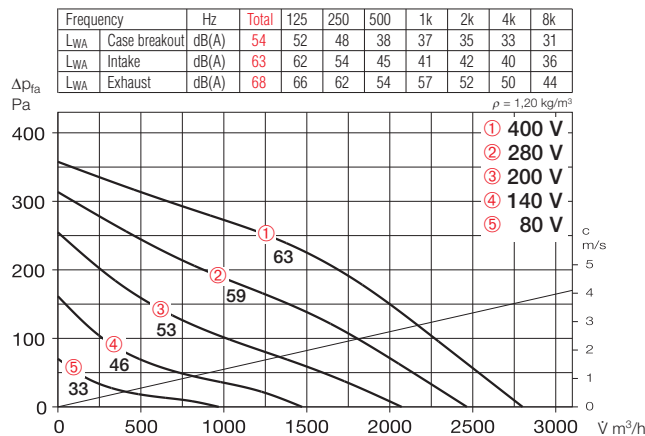

Accessories

Gravity shutter

Type VK 60/35 Ref. no. 0878

Air stream operated louvres, light grey polymer.



External louver

Type WSG 60/35 Ref. no. 0113

Heavy duty construction made from profile anodised aluminium extrusion.



Vol. control damper for ducting

Type JVK 60/35 Ref. no. 6914

Casing with flanges on both sides. The control mechanism is outside the airstream. For electrical drive, see STM, accessory.



Circular spigot

Type FSK 60/35 Ref. no. 0835

For cost effective adaption of rectangular fans into circular ducting systems with Ø 355 mm.



Flexible connectors

Type VS 60/35 Ref. no. 5698

Flexible in-duct connector with flanges on both sides.



Counterflange

Type GF 60/35 Ref. no. 6923

Flange frames made of galvanised steel for connection to ducting.



Rectangular attenuator

Type KSD 60/30-35 No. 8730

For in-duct installation on intake or exhaust side.



Air-duct filter

Type KLF 60/30-35 G4 No. 8722

Type KLF 60/30-35 F7 No. 8646

Bag filter with a large cross section area. Galvanised steel casing with flanges on both sides.



Electric heater battery

Type EHR-K 15/60/30-35 No. 8706

Type EHR-K 30/60/30-35 No. 8707

Heating elements enclosed in a galvanised steel casing with connecting flanges on both sides.

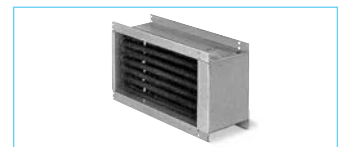

Temperature control system for electric heater battery

Type EHSD 16 Ref. no. 5003



Warm water heater battery

Type WHR 2/60/30-35 No. 8786

Type WHR 4/60/30-35 No. 8787

For in-duct installation.

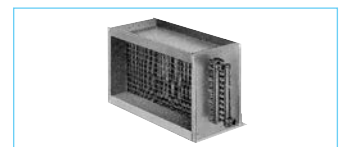

Temperature control system for warm water heater battery

Type WHS HE¹⁾ Ref. no. 8319

¹⁾ In model WHR 4/60/30-35 the heat output is reduced to 2200 l/h.



KR

Suitable for polluted air.



Dim. in mm

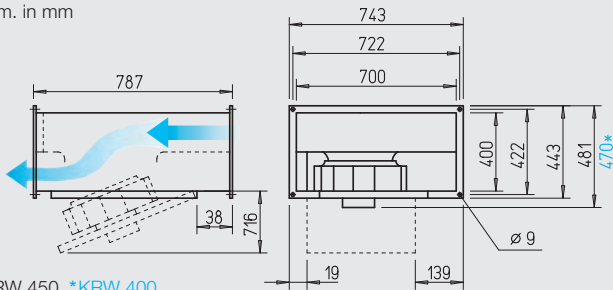

KRW 450, *KRW 400

Features of KR and SKR

- High pressure and high volume with high efficiency centrifugal fan.
- Particularly easy to service (cleaning) thanks to the swing-out motor impeller unit.
- For cleaning, easy access and therefore suitable for extraction of polluted air.
- Straight through-flow.
- Compact design, convenient installation.

Special features of SKR

- Lowest sound levels for intake and case breakout at higher power density.

Specification

Casing KR
Made of galvanised steel. Flanged (20 mm) on both ends for in-duct installation.

Casing SKR
As above, but with additional sound insulation with 50 mm thick mineral fibre board, inside lined with a sound deadening perforated plate.

Common features of KR and SKR

Impeller
Centrifugal, backward curved impeller made of polymer. Aerodynamically optimised, intake air flow by means of an inlet nozzle.

SKR – Sound insulated



Lowest sound levels for intake and case breakout at higher power density.

Use in extract and fresh air systems with specific requirements for low noise levels.



Dim. in mm

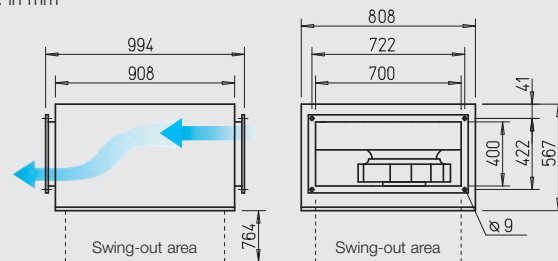

Motor

Through maintenance-free external-rotor motor, on which the impeller is mounted. Closed design. Protection to IP 54. Winding with moisture impregnation. Ball bearing mounted, interference-free. Motor and impeller are dynamically balanced.

Motor protection

Through built-in thermal contacts via a tripping unit (accessories).

Speed control

possible through voltage reduction by means of 5-step transformer or electronic (stepless). Duties at different speeds are exemplarily given in the performance curve.

Electrical connection

Terminal box (IP 54) fitted to flying lead.

Installation

Installation in any position. Allowance must be made for the motor swing out access.

Sound Levels

Above the performance curve, total values and spectrum are given for:

- Sound level case breakout
- Sound level intake
- Sound level exhaust
- The sound power level (on intake) is additionally shown within the performance curve for corresponding control voltages. In the table below you can also find:
 - Case breakout sound level at 4 m (free field conditions).

Type	Ref. no.	Air flow volume (FID)	Nominal R.P.M.	Sound press. case breakout	Motor power		Wiring diagram	max. air flow temperature at full load		Weight net approx.	Speed controller 5-step with full motor protection		Full motor protection device for connection of built-in thermal contacts	
		V m³/h			min⁻¹	kW		A	+°C		+°C	kg	Type	Ref. no.
Single phase, 230 V, 50 Hz, capacitor motor, protection to IP 54														
KRW 400/4/70/40	6150	4970	1320	44	0.57	2.60	536.1	60	60	39,0	MWS 5	1949	MW	1579
KRW 450/4/70/40	6151	6650	1390	51	1.04	4.80	536.1	60	60	38,7	MWS 7,5	1950	MW	1579
Three phase, 230/400 V, 50 Hz, protection to IP 54														
KRD 450/4/70/40 ^{1) 2)}	8694	5830	1430	47	0.82	2.80/1.60	860	60	40	48,5	RDS 4	1316	MD	5849
Sound insulated model SKR – Single phase motor, 230 V, 50 Hz, capacitor motor, protection to IP 54														
SKRW 400/4/70/40	6143	4940	1330	42	0.53	2.40	536.1	60	60	62,0	MWS 5	1949	MW	1579
Sound insulated model SKR – Three phase motor, 230/400 V, 50 Hz, protection to IP 54														
SKRD 450/4/70/40	8196	5430	1430	46	0.82	2.70/1.60	860	60	40	69,3	RDS 4	1316	MD	5849
SKRD 500/6/70/40 ¹⁾	8197	4620	920	36	0.40	1.40/0.82	860	60	60	64,1	RDS 2	1315	MD	5849

1) Characteristic curve diagram on www.HeliosSelect.de 2) Dimensional drawing on www.HeliosSelect.de

KRW 400/4/70/40

Frequency	Hz	Total	125	250	500	1k	2k	4k	8k
L _{WA} Case breakout		dB(A) 64	57	61	54	54	50	45	38
L _{WA} Intake		dB(A) 74	71	66	64	66	65	60	53
L _{WA} Exhaust		dB(A) 84	75	77	74	80	76	70	63

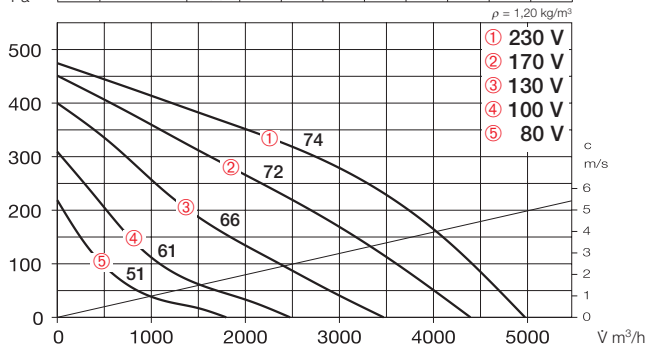

KRW 450/4/70/40

Frequency	Hz	Total	125	250	500	1k	2k	4k	8k
L _{WA} Case breakout		dB(A) 71	61	70	62	59	53	49	44
L _{WA} Intake		dB(A) 79	74	73	70	70	69	66	58
L _{WA} Exhaust		dB(A) 90	80	83	81	84	81	76	68

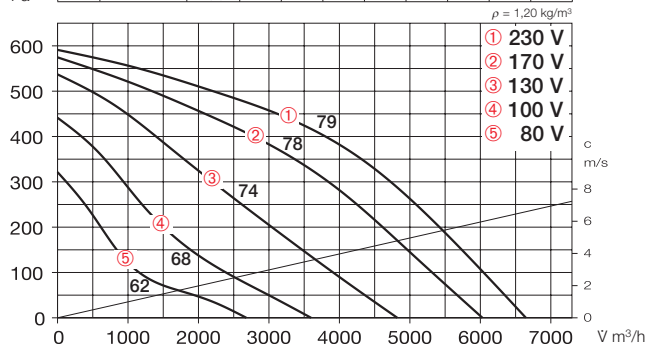

SKRW 400/4/70/40

Frequency	Hz	Total	125	250	500	1k	2k	4k	8k
L _{WA} Case breakout		dB(A) 62	58	59	47	44	40	36	34
L _{WA} Intake		dB(A) 69	68	61	58	53	51	46	42
L _{WA} Exhaust		dB(A) 79	73	71	67	73	70	65	58

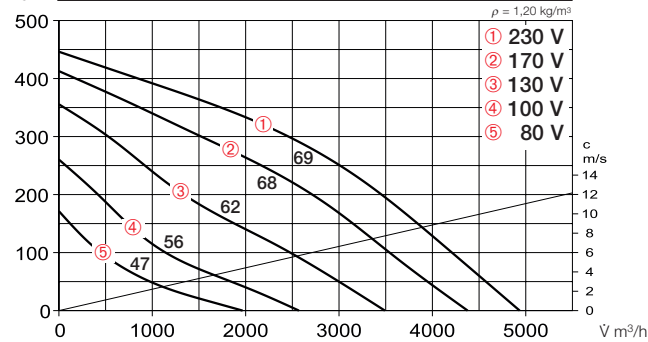

SKRD 450/4/70/40

Frequency	Hz	Total	125	250	500	1k	2k	4k	8k
L _{WA} Case breakout		dB(A) 66	64	61	49	46	40	37	36
L _{WA} Intake		dB(A) 72	70	65	62	56	51	49	44
L _{WA} Exhaust		dB(A) 80	76	74	69	68	61	60	56

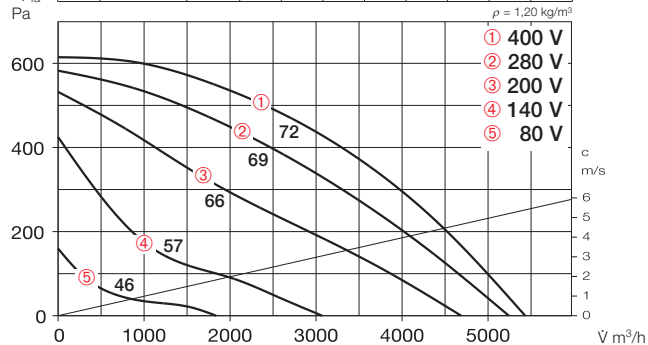

Accessories

Gravity shutter

Type VK 70/40 Ref. no. 0879

Air stream operated louvres, light grey polymer.



External louver

Type WSG 70/40 Ref. no. 0114

Heavy duty construction made from profile anodised aluminium extrusion.



Vol. control damper for ducting

Type JVK 70/40 Ref. no. 6915

Casing with flanges on both sides. The control mechanism is outside the airstream. For electrical drive, see STM, accessory.



Circular spigot

Type FSK 70/40 Ref. no. 0840

For cost effective adaption of rectangular fans into circular ducting systems with Ø 400 mm.



Flexible connectors

Type VS 70/40 Ref. no. 5699

Flexible in-duct connector with flanges on both sides.



Counterflange

Type GF 70/40 Ref. no. 6924

Flange frames made of galvanised steel for connection to ducting.



Rectangular attenuator

Type KSD 70/40 Ref. no. 8731

For in-duct installation on intake or exhaust side.



Air-duct filter

Type KLF 70/40 G4 No. 8723

Type KLF 70/40 F7 No. 8647

Bag filter with a large cross section area. Galvanised steel casing with flanges on both sides.



Warm water heater battery

Type WHR 2/70/40 No. 8788

Type WHR 4/70/40 No. 8789

For in-duct installation.

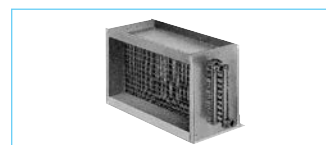

Temperature control system for warm water heater battery

Type WHS HE¹⁾ Ref. no. 8319

¹⁾ In model WHR 4/70/40 the heat output is reduced to 2200 l/h.

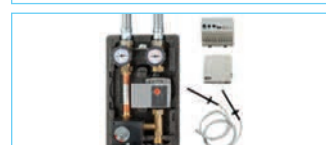

Accessory details Page

Shutters, grilles and louvres	420, 487 on
Filters, heater batteries and attenuators	421 on
Temperature control systems for heater batteries	427, 432 on
Speed controller and full motor protection devices	525 on

KR

Suitable for polluted air.



Dim. in mm

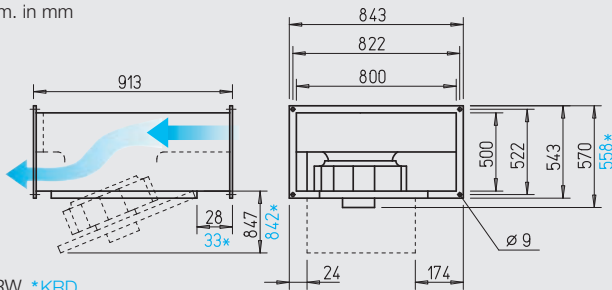

KRW, *KRD

Features of KR and SKR

- High pressure and high volume with high efficiency centrifugal fan.
- Particularly easy to service (cleaning) thanks to the swing-out motor impeller unit.
- For cleaning, easy access and therefore suitable for extraction of polluted air.
- Straight through-flow.
- Compact design, convenient installation.

Special features of SKR

- Lowest sound levels for intake and case breakout at higher power density.

Specification

- Casing KR**
Made of galvanised steel. Flanged (20 mm) on both ends for in-duct installation.

- Casing SKR**
As above, but with additional sound insulation with 50 mm thick mineral fibre board, inside lined with a sound deadening perforated plate.

Common features of KR and SKR

- Impeller**
Centrifugal, backward curved impeller made of polymer. Aerodynamically optimised, intake air flow by means of an inlet nozzle.

SKR – Sound insulated



Lowest sound levels for intake and case breakout at higher power density.

Use in extract and fresh air systems with specific requirements for low noise levels.



Dim. in mm

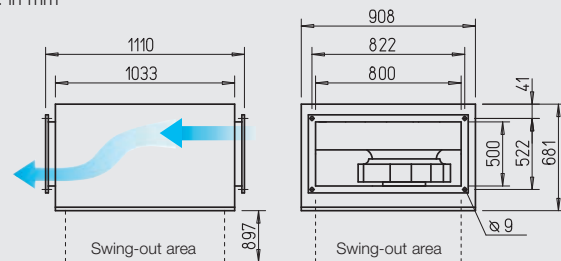

Motor

Through maintenance-free external-rotor motor, on which the impeller is mounted. Closed design. Protection to IP 54. Winding with moisture impregnation. Ball bearing mounted, interference-free. Motor and impeller are dynamically balanced.

Motor protection

Through built-in thermal contacts via a tripping unit (accessories).

Speed control

possible through voltage reduction by means of 5-step transformer or electronic (stepless). Duties at different speeds are exemplarily given in the performance curve.

Electrical connection

Terminal box (IP 54) fitted to flying lead.

Installation

Installation in any position. Allowance must be made for the motor swing out access.

Sound Levels

Above the performance curve, total values and spectrum are given for:

- Sound level case breakout
- Sound level intake
- Sound level exhaust
- The sound power level (on intake) is additionally shown within the performance curve for corresponding control voltages. In the table below you can also find:
 - Case breakout sound level at 4 m (free field conditions).

Type	Ref. no.	Air flow volume (FID)	Nominal R.P.M.	Sound press. case breakout	Motor power		Wiring diagram	max. air flow temperature at full load control		Weight net approx.	Speed controller 5-step with full motor protection		Full motor protection device for connection of built-in thermal contacts	
					kW	A		+°C	+°C		kg	Type	Ref. no.	Type
Single phase, 230 V, 50 Hz, capacitor motor, protection to IP 54														
KRW 500/4/80/50	6152	9700	1370	52	1.55	6.80	536.1	60	60	66.9	MWS 10	1946	MW	1579
Three phase, 230/400 V, 50 Hz, protection to IP 54														
KRD 500/4/80/50 A	8643	8430	1360	52	1.21	4.70/2.70	860	60	60	64.2	RDS 7	1578	MD	5849
Sound insulated model SKR – Single phase motor, 230 V, 50 Hz, capacitor motor, protection to IP 54														
SKRW 500/4/80/50	6144	9540	1360	48	1.49	6.60	536.1	60	60	93.3	MWS 10	1946	MW	1579
Sound insulated model SKR – Three phase motor, 230/400 V, 50 Hz, protection to IP 54														
SKRD 500/4/80/50	8198	8050	1360	48	1.19	4.60/2.70	860	60	60	89.2	RDS 7	1578	MD	5849

KRW 500/4/80/50

Frequency		Hz	Total	125	250	500	1k	2k	4k	8k
LWA	Case breakout	dB(A)	72	65	69	64	61	57	51	45
LWA	Intake	dB(A)	82	75	73	75	76	73	69	62
LWA	Exhaust	dB(A)	91	79	83	81	88	84	79	71

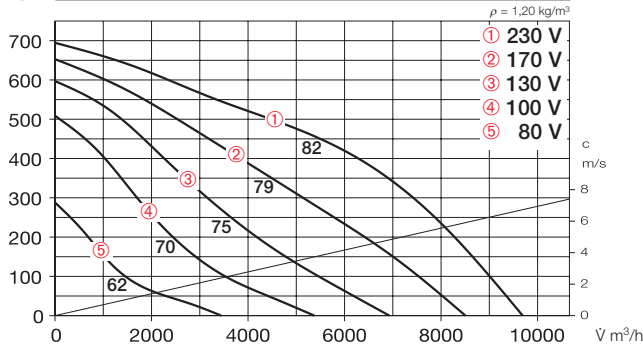

KRD 500/4/80/50 A

Frequency		Hz	Total	125	250	500	1k	2k	4k	8k
LWA	Case breakout	dB(A)	72	71	65	61	55	47	44	45
LWA	Intake	dB(A)	78	74	72	69	68	65	64	63
LWA	Exhaust	dB(A)	85	78	80	78	77	72	69	69

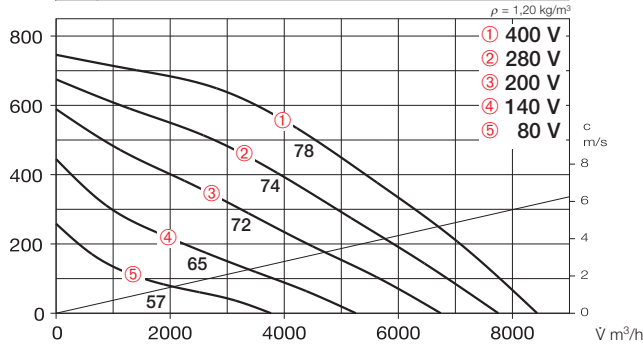

SKRW 500/4/80/50

Frequency		Hz	Total	125	250	500	1k	2k	4k	8k
LWA	Case breakout	dB(A)	68	65	63	54	53	46	43	36
LWA	Intake	dB(A)	72	69	65	60	62	60	55	51
LWA	Exhaust	dB(A)	84	74	76	74	80	74	69	61

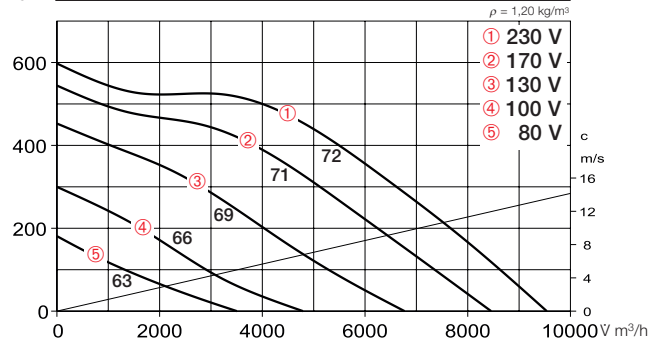

SKRD 500/4/80/50

Frequency		Hz	Total	125	250	500	1k	2k	4k	8k
LWA	Case breakout	dB(A)	68	68	60	52	45	40	40	35
LWA	Intake	dB(A)	74	74	62	58	53	51	51	49
LWA	Exhaust	dB(A)	80	76	73	70	69	64	62	60

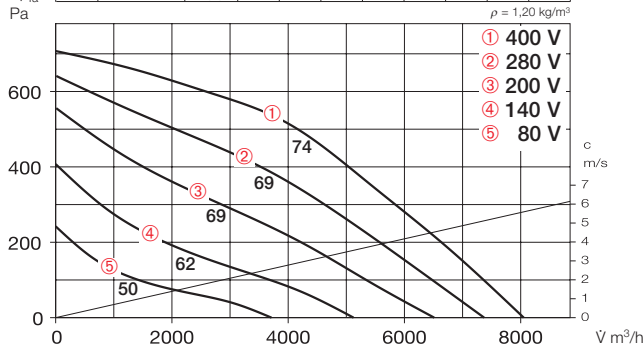

Accessories

Gravity shutter

Type VK 80/50 Ref. no. 0880

Air stream operated louvres, light grey polymer.



External louver

Type WSG 80/50 Ref. no. 0115

Heavy duty construction made from profile anodised aluminium extrusion.



Vol. control damper for ducting

Type JVK 80/50 Ref. no. 6916

Casing with flanges on both sides. The control mechanism is outside the airstream. For electrical drive, see STM, accessory.



Circular spigot

Type FSK 80/50 Ref. no. 0842

For cost effective adaption of rectangular fans into circular ducting systems with Ø 500 mm.



Flexible connectors

Type VS 80/50 Ref. no. 5700

Flexible in-duct connector with flanges on both sides.



Counterflange

Type GF 80/50 Ref. no. 6925

Flange frames made of galvanised steel for connection to ducting.



Rectangular attenuator

Type KSD 80/50 Ref. no. 8732

For in-duct installation on intake or exhaust side.



Air-duct filter

Type KLF 80/50 G4 No. 8670

Type KLF 80/50 F7 No. 8654

Bag filter with a large cross section area. Galvanised steel casing with flanges on both sides.



Warm water heater battery

Type WHR 2/80/50 No. 8795

Type WHR 4/80/50 No. 8796

For in-duct installation.

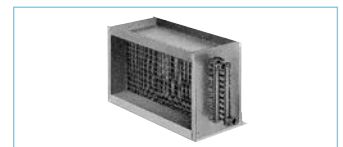

Accessory details Page

Shutters, grilles and louvres	420, 487 on
Filters, heater batteries and attenuators	421 on
Speed controller and full motor protection devices	525 on

KR

Suitable for polluted air.



Dim. in mm

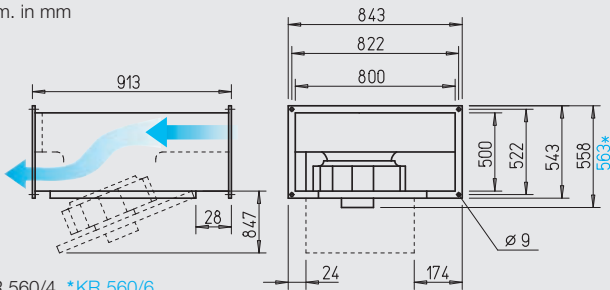

KR 560/4, *KR 560/6

■ **Features of KR and SKR**

- High pressure and high volume with high efficiency centrifugal fan.
- Particularly easy to service (cleaning) thanks to the swing-out motor impeller unit.
- For cleaning, easy access and therefore suitable for extraction of polluted air.
- Straight through-flow.
- Compact design, convenient installation.

■ **Special features of SKR**

- Lowest sound levels for intake and case breakout at higher power density.
- **Specification**
- Casing KR**
Made of galvanised steel. Flanged (20 mm) on both ends for in-duct installation.
- Casing SKR**
As above, but with additional sound insulation with 50 mm thick mineral fibre board, inside lined with a sound deadening perforated plate.

SKR – Sound insulated



Lowest sound levels for intake and case breakout at higher power density.

Use in extract and fresh air systems with specific requirements for low noise levels.



Dim. in mm

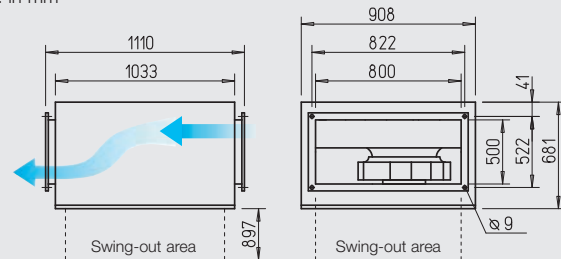

■ **Common features of KR and SKR**

- Impeller**
Centrifugal, backward curved impeller made of polymer. Aero-dynamically optimised, intake air flow by means of an inlet nozzle.
- Motor**
Through maintenance-free external-rotor motor, on which the impeller is mounted. Closed design. Protection to IP 54. Wind-ing with moisture impregnation. Ball bearing mounted, interference-free. Motor and impeller are dynamically balanced.
- Motor protection**
Through built-in thermal contacts via a tripping unit (accessories).

Speed control

possible through voltage reduction by means of 5-step transformer or electronic (stepless). Duties at different speeds are exemplarily given in the performance curve.

Electrical connection

Terminal box (IP 54) fitted to flying lead.

Installation

Installation in any position. Allowance must be made for the motor swing out access.

Note	Page
Selection chart	372
Technical description	373
Design guidelines	10 on
Modul. system components	370

Type	Ref. no.	Air flow volume (FID)	Nominal R.P.M.	Sound press. case breakout	Motor power		Wiring diagram	max. air flow temperature at full load		Weight net approx.	Speed controller 5-step with full motor protection		Full motor protection device for connection of built-in thermal contacts	
		V m³/h			min⁻¹	kW		A	+°C		+°C	kg	Type	Ref. no.
Three phase, 230/400 V, 50 Hz, protection to IP 54														
KRD 560/6/80/50	8842	7460	880	41	0.64	2.50/1.40	860	60	60	61.9	RDS 2	1315	MD	5849
KRD 560/4/80/50	6147	11970	1350	55	2.33	7.80/4.50	860	45	45	64.1	RDS 7	1578	MD	5849
Sound insulated model SKR – Three phase motor, 230/400 V, 50 Hz, protection to IP 54														
SKRD 560/6/80/50	8199	7600	880	36	0.66	2.50/1.50	860	60	60	86.9	RDS 2	1315	MD	5849

KRD 560/6/80/50

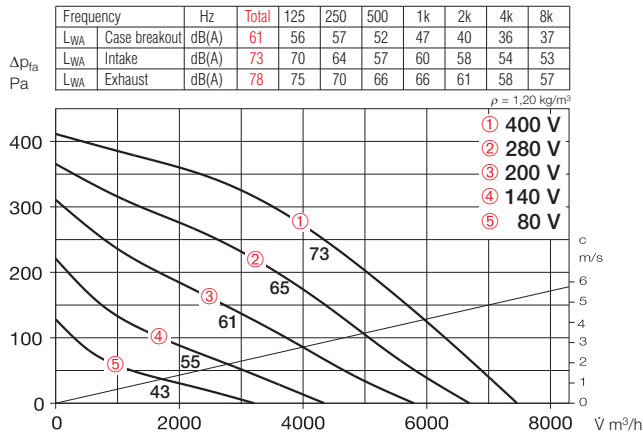

KRD 560/4/80/50

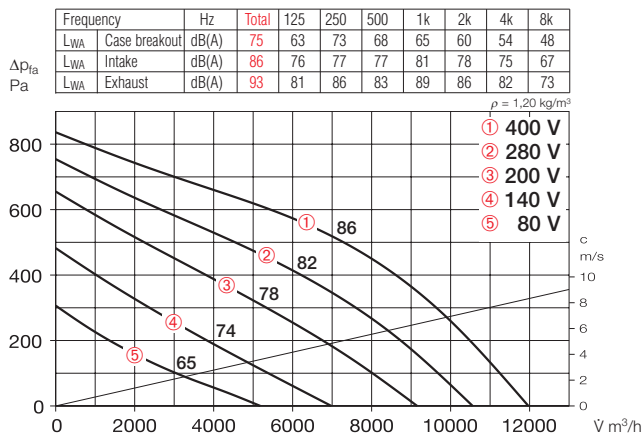

SKRD 560/6/80/50

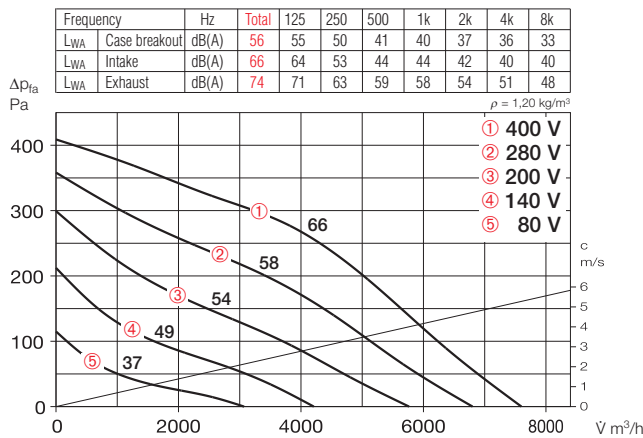

Sound Levels

- Above the performance curve, total values and spectrum are given for:
- Sound level case breakout
 - Sound level intake
 - Sound level exhaust
- The sound power level (on intake) is additionally shown within the performance curve for corresponding control voltages. In the table below you can also find:
- Case breakout sound level at 4 m (free field conditions).

Accessories

Gravity shutter

Type VK 80/50 Ref. no. 0880
Air stream operated louvres, light grey polymer.



External louver

Type WSG 80/50 Ref. no. 0115
Heavy duty construction made from profile anodised aluminium extrusion.



Vol. control damper for ducting

Type JVK 80/50 Ref. no. 6916
Casing with flanges on both sides. The control mechanism is outside the airstream. For electrical drive, see STM, accessory.



Circular spigot

Type FSK 80/50 Ref. no. 0842
For cost effective adaption of rectangular fans into circular ducting systems with Ø 500 mm.



Flexible connectors

Type VS 80/50 Ref. no. 5700
Flexible in-duct connector with flanges on both sides.



Counterflange

Type GF 80/50 Ref. no. 6925
Flange frames made of galvanised steel for connection to ducting.



Rectangular attenuator

Type KSD 80/50 Ref. no. 8732
For in-duct installation on intake or exhaust side.



Air-duct filter

Type KLF 80/50 G4 No. 8670
Type KLF 80/50 F7 No. 8654
Bag filter with a large cross section area. Galvanised steel casing with flanges on both sides.



Warm water heater battery

Type WHR 2/80/50 No. 8795
Type WHR 4/80/50 No. 8796
For in-duct installation.

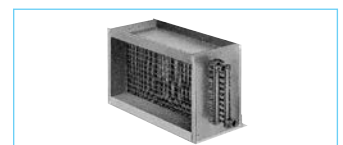

Accessory details Page

Shutters, grilles and louvres	420, 487 on
Filters, heater batteries and attenuators	421 on
Speed controller and full motor protection devices	525 on

KR

Suitable for polluted air.



Dim. in mm

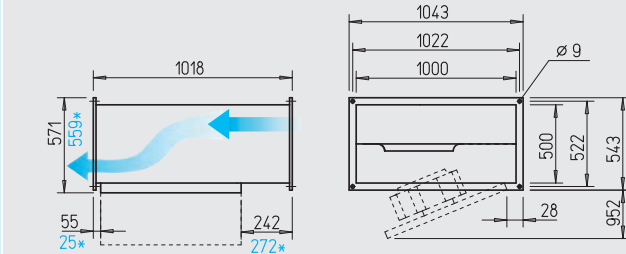

KR 630/4, *KR 630/6

SKR – Sound insulated



Lowest sound levels for intake and case breakout at higher power density.

Use in extract and fresh air systems with specific requirements for low noise levels.



Dim. in mm

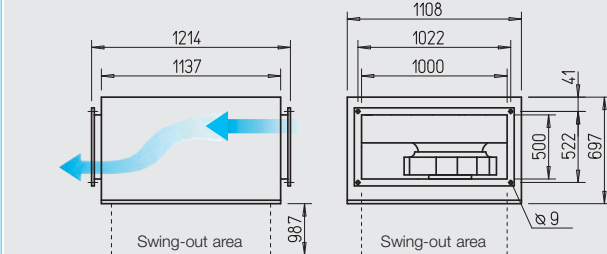

■ **Features of KR and SKR**

- High pressure and high volume with high efficiency centrifugal fan.
- Particularly easy to service (cleaning) thanks to the swing-out motor impeller unit.
- For cleaning, easy access and therefore suitable for extraction of polluted air.
- Straight through-flow.
- Compact design, convenient installation.

■ **Special features of SKR**

- Lowest sound levels for intake and case breakout at higher power density.
- **Specification**
- Casing KR**
Made of galvanised steel. Flanged (20 mm) on both ends for in-duct installation.
- Casing SKR**
As above, but with additional sound insulation with 50 mm thick mineral fibre board, inside lined with a sound deadening perforated plate.

■ **Common features of KR and SKR**

- Impeller**
Centrifugal, backward curved impeller made of polymer. Aero-dynamically optimised, intake air flow by means of an inlet nozzle.
- Motor**
Through maintenance-free external-rotor motor, on which the impeller is mounted. Closed design. Protection to IP 54. Wind-ing with moisture impregnation. Ball bearing mounted, interference-free. Motor and impeller are dynamically balanced.
- Motor protection**
Through built-in thermal contacts via a tripping unit (accessories).

Speed control

possible through voltage reduction by means of 5-step transformer or electronic (stepless). Duties at different speeds are exemplarily given in the performance curve.

Electrical connection

Terminal box (IP 54) fitted to flying lead.

Installation

Installation in any position. Allowance must be made for the motor swing out access.

Note	Page
Selection chart	372
Technical description	373
Design guidelines	10 on
Modul. system components	370

Type	Ref. no.	Air flow volume (FID)	Nominal R.P.M.	Sound press. case breakout	Motor power		Wiring diagram	max. air flow temperature at full load		Weight net approx.	Speed controller 5-step with full motor protection		Full motor protection device for connection of built-in thermal contacts	
					kW	A		+°C	+°C		Type	Ref. no.	Type	Ref. no.
Three phase, 230/400 V, 50 Hz, protection to IP 54														
KRD 630/6/100/50	8846	8740	910	44	1.10	4.90/2.90	860	60	60	84.0	RDS 7	1578	MD	5849
KRD 630/4/100/50	6148	12100	1320	55	3.31	9.90/5.70	860	55	55	95.6	RDS 11	1332	MD	5849
Sound insulated model SKR – Three phase motor, 230/400 V, 50 Hz, protection to IP 54														
SKRD 630/6/100/50	8295	8450	900	43	1.17	5.00/2.90	860	60	60	112.8	RDS 7	1578	MD	5849

KRD 630/6/100/50

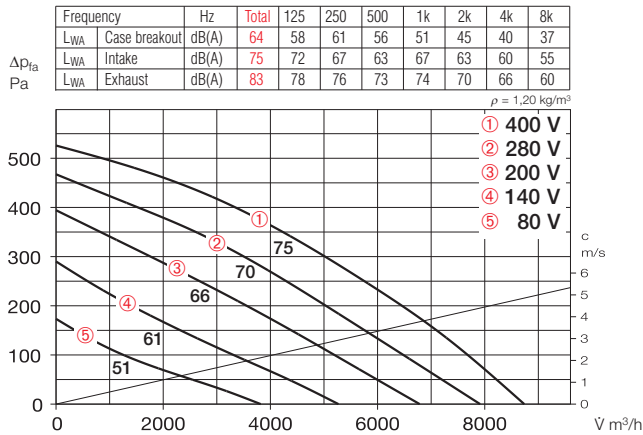

KRD 630/4/100/50

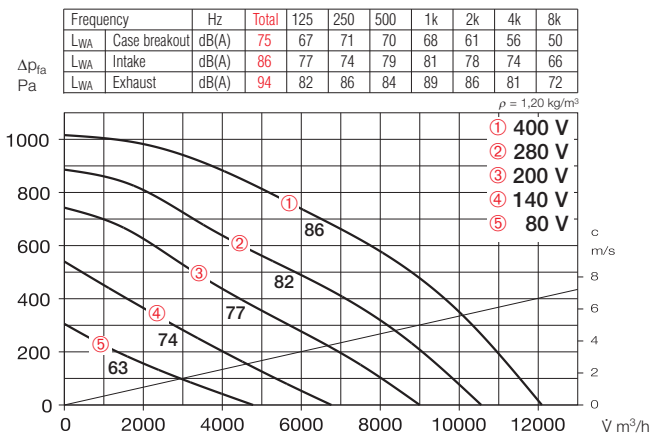

SKRD 630/6/100/50

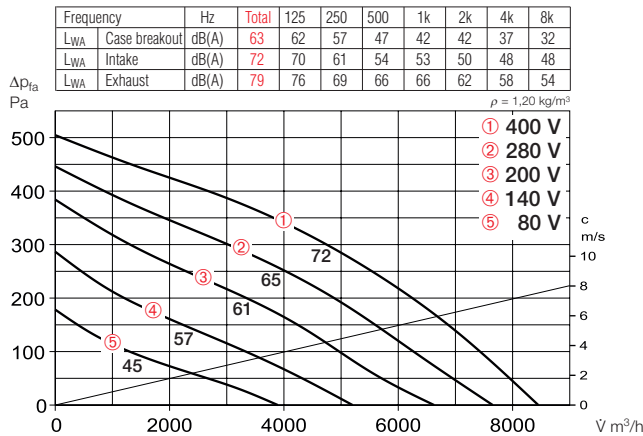

Sound Levels

- Above the performance curve, total values and spectrum are given for:
- Sound level case breakout
 - Sound level intake
 - Sound level exhaust
- The sound power level (on intake) is additionally shown within the performance curve for corresponding control voltages. In the table below you can also find:
- Case breakout sound level at 4 m (free field conditions).

Accessories

Gravity shutter

Type VK 100/50 Ref. no. 0881
Air stream operated louvres, light grey polymer.

External louver

Type WSG 100/50 Ref. no. 0116
Heavy duty construction made from profile anodised aluminium extrusion.

Vol. control damper for ducting

Type JVK 100/50 Ref. no. 6917
Casing with flanges on both sides. The control mechanism is outside the airstream. For electrical drive, see STM, accessory.

Circular spigot

Type FSK 100/50 Ref. no. 0843
For cost effective adaption of rectangular fans into circular ducting systems with $\varnothing 500 \text{ mm}$.

Flexible connectors

Type VS 100/50 Ref. no. 5701
Flexible in-duct connector with flanges on both sides.

Counterflange

Type GF 100/50 Ref. no. 6926
Flange frames made of galvanised steel for connection to ducting.

Rectangular attenuator

Type KSD 100/50 Ref. no. 8733
For in-duct installation on intake or exhaust side.

Air-duct filter

Type KLF 100/50 G4 No. 8671
Type KLF 100/50 F7 No. 8655
Bag filter with a large cross section area. Galvanised steel casing with flanges on both sides.

Warm water heater battery

Type WHR 2/100/50 No. 8797
Type WHR 4/100/50 No. 8798
For in-duct installation.

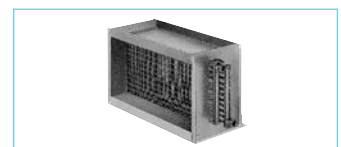
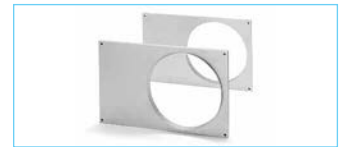

Accessory details Page

Shutters, grilles and louvres	420, 487 on
Filters, heater batteries and attenuators	421 on
Speed controller and full motor protection devices	525 on

■ Counterflange GF

Designed for connecting rectangular fans and accessories to ducting where the flange frames are made of galvanised sheet steel.

■ Connectors VS

Flexible ducting connector with flange frames on both ends, made of galvanised sheet steel, with sealing lip all around; leak proof to VDI 3803, temperature resistance from -10 °C to +80 °C. The elastic sleeve in the middle section is made of plastic fibre bonded material.

In order to prevent the vibration transmission and compensate small misalignments on site, the flexible connectors are fitted between the ducting and fan on intake and exhaust side.

For explosion proof rectangular fans use VS Ex (explosion-proof) types.

GF and VS

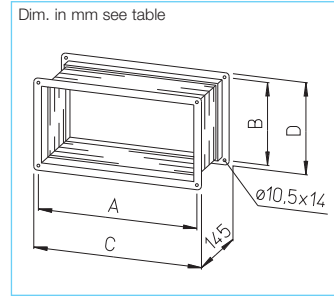
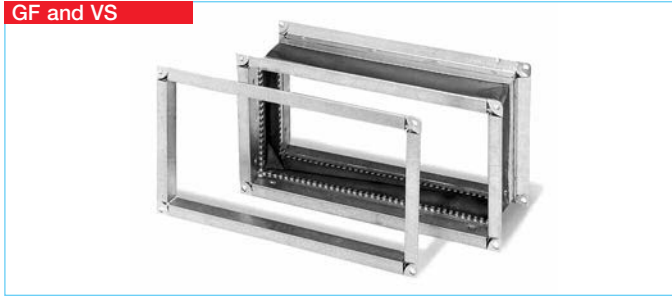

Counterflange GF		Connector VS		Connector for Ex-proof fans		Fits fan duct nominal size mm	Dimensions in mm				Weight approx. kg	
Type	Ref. no.	Type	Ref. no.	Type	Ref. no.		A	B	C	D	GF	VS
GF 30/15	6918	VS 30/15	6928	—	—	300 x 150	320	170	340	190	0.7	1.8
GF 40/20	6919	VS 40/20	5694	—	—	400 x 200	420	220	440	240	0.8	2.3
GF 50/25	6920	VS 50/25	5695	VS 50/25 Ex	0265	500 x 250	520	270	540	290	0.9	2.8
GF 50/30	6921	VS 50/30	5696	VS 50/30 Ex	0266	500 x 300	520	320	540	340	1.0	2.9
GF 60/30	6922	VS 60/30	5697	VS 60/30 Ex	0267	600 x 300	620	320	640	340	1.1	3.2
GF 60/35	6923	VS 60/35	5698	VS 60/35 Ex	0268	600 x 350	620	370	640	390	1.1	3.4
GF 70/40	6924	VS 70/40	5699	VS 70/40 Ex	0269	700 x 400	720	420	740	440	1.2	3.7
GF 80/50	6925	VS 80/50	5700	—	—	800 x 500	820	520	840	540	1.5	4.5
GF 100/50	6926	VS 100/50	5701	—	—	1000 x 500	1020	520	1040	540	1.7	5.0

■ Volume control dampers JVK

Flanged casing on both sides, made of galvanised sheet steel, designed to fit into rectangular fans. The blades are hollow and their shafts run embedded in polymer guides. The external control lever adjusts all blades equally.

The control mechanism is also outside the airstream and secured against operational interruptions therefore unaffected by airborne contamination.

The blades create an additional pressure loss (shown in the adjacent diagram) which must be considered when designing.

JVK

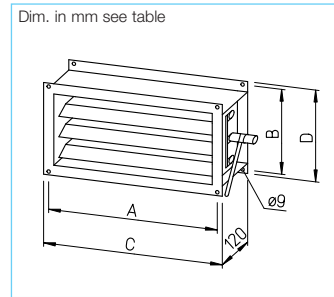

Type	Ref. no.	Fits fan duct nominal size mm	Duct-fan Ø mm	Dimensions in mm				Weight approx. kg
				A	B	C	D	
JVK 30/15	6927	300 x 150	180	320	170	340	190	3.5
JVK 40/20	6910	400 x 200	200–250	420	220	440	240	4.0
JVK 50/25	6911	500 x 250	315	520	270	540	290	5.0
JVK 50/30	6912	500 x 300	250	520	320	540	340	6.0
JVK 60/30	6913	600 x 300	285	620	320	640	340	7.0
JVK 60/35	6914	600 x 350	315–400	620	370	640	390	7.2
JVK 70/40	6915	700 x 400	355–450	720	420	740	440	9.0
JVK 80/50	6916	800 x 500	400–500	820	520	840	540	11.7
JVK 100/50	6917	1000 x 500	450–630	1020	520	1040	540	13.5

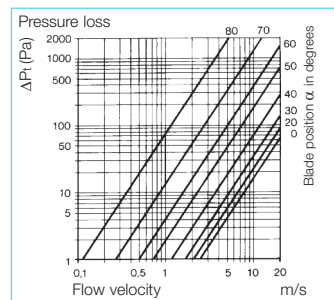

■ Accessories

Servo motor

STM 10 230 V Ref. no. 8791

Electric drive for opening and closing of volume control dampers JVK. Installation in any position by using fixing clamp (for Ø 8–26 or □ 8–26 mm) and fixing with the attached anti-rotation locking bracket.

Adjustment of shutter position by using the gear unlock button.

Output signal available to indicate “open” or “close”. Visible indication of shutter position (0 – 90°).

Auxiliary switch

STM 2P Ref. no. 8794

The servo motor STM 10 230 V can also be operated with an auxiliary switch component. Two adjustable micro-switches indicate the control position. The adjustable angle settings can be set. Position indication via adjustment ring (mechanical, snap-on).

STM 10 / STM 2P



■ Technical data

Supply voltage	100–240 VAC
Frequency	50/60 Hz
Torque	10 Nm
Rotation angle	0 to 95°
Operation	2.5 W
Running time (open/close)	150 s
Left/right motor rotation	reversible
Ambient temp.	-30 to +50 °C
Protection	IP 54
Protection class	II
Dim. mm	W 80 x H 124 x D 62
Weight approx.	0.75 kg
Wiring diagram no.	1087

Flexible in planning and installation.



Helios air treatment components ensure clean, warm and smooth air – regardless of whether they were located in ducting or duct ventilation systems. The extensive range includes all sizes and powers, perfectly coordinated to Helios fans. This allows the necessary flexibility in terms of planning and installation.

PURE

Air filters

For wall and ceiling installation in filter classes G4 and F7. For installation in ducts with connection flanges on both sides and air filter boxes with common standard duct diameters.

422^{on}

PREHEATED

Heater batteries and temperature control systems

For room air at a pleasant temperature, in finely graduated power ranges. Choose from electrical or warm water design.

425^{on}

LOW-NOISE

Attenuators

Available in all sizes and designs, for installation in ducts or pipelines. Made from galvanised sheet steel or flexible aluminium ducting.

434^{on}

■ **Simple to install components for effective solutions.**

The controlled intake of outside air is essential for creating a good ventilation system and meeting the regulations in most cases. The purification of supply air is a must nowadays. For this purpose, Helios offers simple and effective components for various installation conditions.

■ **Accessories for air filters**

Complete kit to monitor the pressure drop and thus the contamination of air filters. The gold coated connector makes it suitable for BMS applications. Pressure range 50 – 500 Pa, ambient temperature from –20 to +85 °C and air flow temperature from –20 to +85 °C.

Differential pressure switch

Type DDS Ref. no. 0445

■ **Series LF, for wall and ceiling installation**

Stylish design to cover ventilation openings. Air flow volumes from 200 to 4000 m³/h.

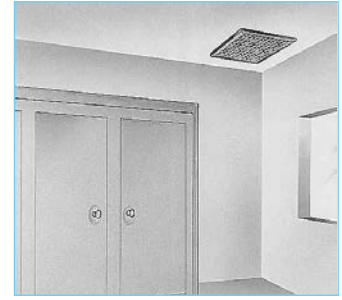
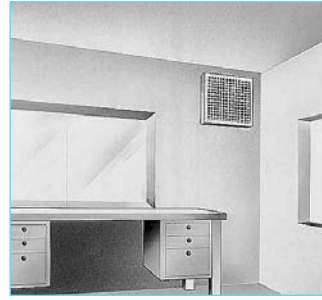

■ **LFBR, filter box for duct connection**

For in-line installation of circular ducting with dimensions from 100 to 400 mm Ø and air flow volumes from 100 to 4000 m³/h.

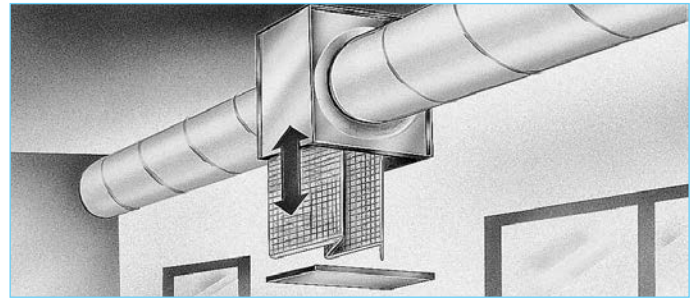

■ **KLF, rectangular air filter**

for direct installation into ducting. Dimensions fit rectangular fan range. Air flow volumes up to 5000 m³/h.

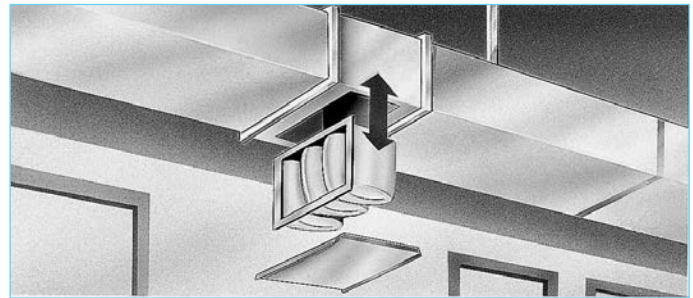

■ **Air filter LF for wall and ceiling installation**

Specifically designed to cover internal ventilation and duct openings on the wall and ceiling. Egg crate grilles superimposed on frames are made of high quality, light grey polymer. Complete flow through of filter mat. Large cross section area of filter reduces the pressure drop and increases the dust storing capacity.

□ **Filter mat** made of washable synthetic fibre, class G 2, thermally bonded, 100 g/m², fire resistant to DIN 53438: F1. 67% particle separation, dust storage capacity: 380 g/m².

□ **Installation** via four concealed holes in the frame, can be doweled in any position.

□ **Cleaning** Depending on the system a filter replacement is necessary if the pressure drop exceeds approximately 1,5 – 2 times of the original value. Remove the filter mat after loosening the egg crate grille and clean both parts in soapy water. Afterwards reinsert it and fix with the four plastic nuts.

□ **Spare filter mats** Due to decay, the mat may need to be replaced after several times of cleaning. See the chart for ordering information of spare filters. Contents: 5 pieces.

LF 200 – 250



LF 315 – 500

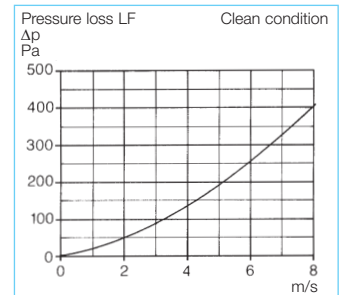
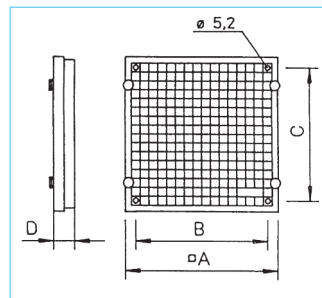
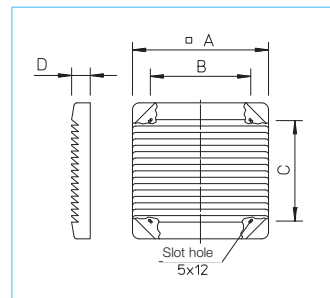
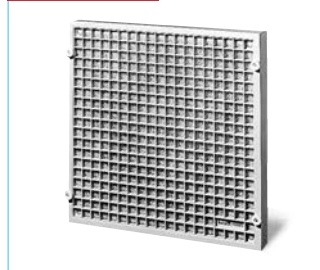

□ **Pressure loss**
Air filters generate a resistance, as shown on the curve above, which must be considered when designing the system.

Type	Ref. no.	fits nominal fan size	maximum dimensions of opening	Dimensions				Weight approx.	Spare filter mats (Contents = 5 pieces)	
				A	B	C	D		Type	Ref. no.
LF 200	0743	200	Ø 200	287	210	210	39.0	0.80	ELF 200	0737
LF 250	0744	250/280	Ø 300	337	240	240	39.0	1.00	ELF 250	0738
LF 315	0745	315	330 x 300	390	343	317	39.0	0.85	ELF 315	0739
LF 355	0746	355	380 x 350	440	393	367	39.0	0.95	ELF 355	0740
LF 400	0747	400	355 x 400	490	443	417	31.5	1.85	ELF 400	0741
LF 500	0748	450/500	475 x 450	540	493	467	31.5	2.25	ELF 500	0742

KLF G4, filter class G4



KLF F7, filter class F7

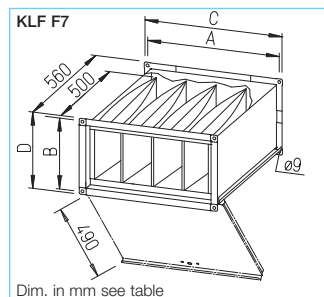
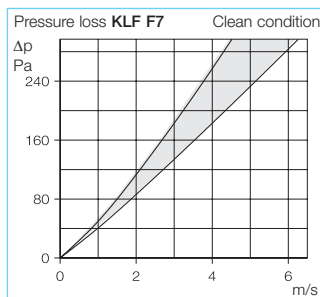
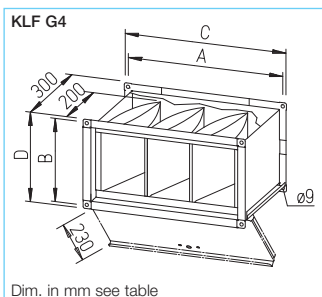
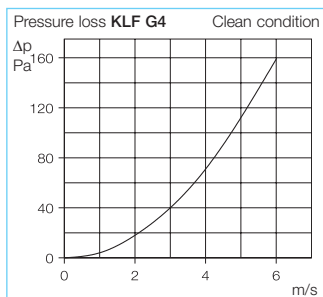

Rectangular air filter KLF

Air filter with flanges at both ends for in-duct installation.

Casing

Made of galvanised steel. The cover is detachable in order to remove filters by means of quick release fasteners.

Bag filter cassette

Held in a frame that is made of galvanised steel. Filter bags with a large cross section area for high dust storage capacity.

Types KLF G4 with filter class G4, made of washable synthetic fibre, highly strengthened, 190 g/m².
DIN 53438 F1, self extinguishing. 91.3% particle separation, dust storage capacity: 354 g/m².

Types KLF F7 with filter class F7, made of synthetic fibre, DIN 53438 F1, self extinguishing. Particle separation rate: approx. 98%. Dust storage capacity: 88.6 g/m².

Note

The integration of the filter with F7 filter class and differential pressure switch DDS (Ref. no. 0445) in external air systems comply with the requirements of VDI 6022.

Installation

Horizontal and vertical (topdown air flow direction) in-duct installation. A free space must be allowed for easy removal of the filter. For areas with restricted space the cover can be detached without tools by an opening angle of more than 45°.

Cleaning

Depending on the system a filter replacement is necessary if the pressure drop exceeds approximately 1.5 – 2 times of the original value.

The filter cassette can be easily removed through the opening on the casing cover. After cleaning or replacement, the filter cassette should be reinserted; by closing the cover the filter cassette is pinched automatically to the casing gaskets.

Spare filter cassettes

Due to decay, the filter cassette may need to be replaced after several times of cleaning. See the chart for ordering information.

Pressure loss

Air filters generate a resistance as shown on the curve above; the grey coloured area demonstrates the air filter resistance of different sizes that must be considered when designing the system.

Accessories

Differential pressure switch

Type DDS Ref. no. 0445
Complete kit to monitor air filters. Pressure range: 50 – 500 Pa.

Type	Ref. no.	fits rectangular fan nominal size cm	Dimensions in mm				Weight approx. kg	Spare filter cassettes (Contents = 2 pieces)	
			A	B	C	D		Type	Ref. no.
Rectangular air filter KLF G4, filter class G4									
KLF 40/20 G4	8720	40/20	420	220	440	240	4.5	EKLF 40/20 G4	8724
KLF 50/25-30 G4	8721	50/25-30	520	270/320	540	340	6.0	EKLF 50/25-30 G4	8725
KLF 60/30-35 G4	8722	60/30-35	620	320/370	640	390	7.0	EKLF 60/30-35 G4	8726
KLF 70/40 G4	8723	70/40	720	420	740	440	8.5	EKLF 70/40 G4	8727
KLF 80/50 G4	8670	80/50	820	520	840	540	13.0	EKLF 80/50 G4	8673
KLF 100/50 G4	8671	100/50	1020	520	1040	540	15.0	EKLF 100/50 G4	8674
Rectangular air filter KLF F7, filter class F7									
KLF 40/20 F7	8644	40/20	420	220	440	240	6.5	EKLF 40/20 F7	8635
KLF 50/25-30 F7	8645	50/25-30	520	270/320	540	340	8.5	EKLF 50/25-30 F7	8636
KLF 60/30-35 F7	8646	60/30-35	620	320/370	640	390	10.5	EKLF 60/30-35 F7	8637
KLF 70/40 F7	8647	70/40	720	420	740	440	13.5	EKLF 70/40 F7	8638
KLF 80/50 F7	8654	80/50	820	520	840	540	20.5	EKLF 80/50 F7	8639
KLF 100/50 F7	8655	100/50	1020	520	1040	540	24.0	EKLF 100/50 F7	8659

LFBR G4, filter class G4



LFBR F7, filter class F7

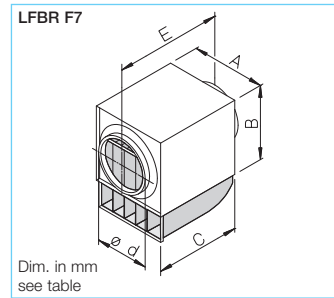
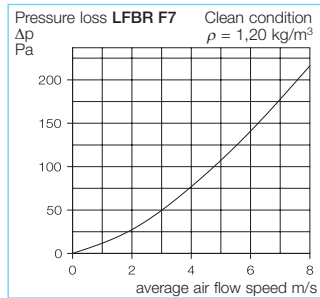
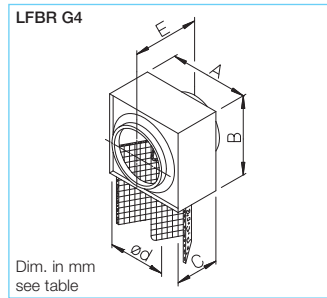
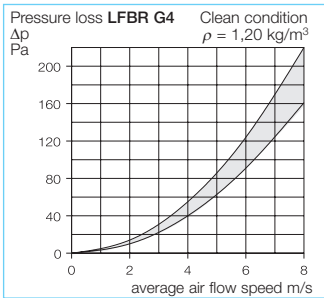

- **Air filter box LFBR**
For in-line installation with circular ducting. Spigots on both ends are fitted with double lip rubber seals, matching nominal size ducting.
- **Casing**
Made of galvanised sheet steel. Access panel fitted with clamp for easy filter change.
- **Filter**
For types LFBR G4 made of

washable plastic fibre, class G4. Temperature resistant up to +100 °C. Fire resistant to DIN 53438 F1, self extinguishing, can be regenerated 10–15 times. 93.8% particle separation, dust storage capacity: 122 g/m².

For types LFBR F7 bag filter, class F7, made of synthetic polymer, 64 g/m². 98% particle separation, dust storage capacity: 88.6 g/m².

- **Installation**
Suitable for installation in any position. A free space for a size of B must be allowed for easy removal of the filter.
- **Cleaning**
Depending on the system a filter replacement is necessary if the pressure drop exceeds approximately 1.5 – 2 times of the original value. After removing the casing-cover pull out the filter element.

- **Spare filter mats**
Due to decay, the mat may need to be replaced after cleaning several times.
- **Pressure loss**
Air filters generate a resistance as shown on the curve above; the grey coloured area demonstrates the air filter resistance of different sizes that must be considered when designing the system.

■ **Accessories**

Differential pressure switch
Type DDS Ref. no. 0445
Complete kit to monitor air filters. Pressure range: 50 – 500 Pa.

■ **Note**
The integration of the filter with F7 filter class and differential pressure switch DDS (Ref. no. 0445) in external air systems comply with the requirements of VDI 6022.

Type	Ref. no.	Connection Ø d	Dimensions in mm				Weight approx. kg	Spare filter (Contents = 5 pieces)	
			A	B	C	E		Type	Ref. no.
Air filter box LFBR G4, filter class G4									
LFBR 100 G4	8576	100	205	170	120	227	1.5	ELFBR 100 G4	8585
LFBR 125 G4	8577	125	215	205	140	252	1.8	ELFBR 125 G4	8586
LFBR 160 G4	8578	160	265	235	155	267	2.4	ELFBR 160 G4	8587
LFBR 200 G4	8579	200	315	275	180	302	3.0	ELFBR 200 G4	8588
LFBR 250 G4	8580	250	365	325	230	352	4.2	ELFBR 250 G4	8589
LFBR 315 G4	8581	315	425	390	330	452	7.5	ELFBR 315 G4	8590
LFBR 355 G4	8583	355	515	495	455	587	12.0	ELFBR 355 G4	8592
LFBR 400 G4	8582	400	515	495	455	587	12.0	ELFBR 400 G4	8591
Air filter box LFBR F7, filter class F7									
(Contents = 2 pieces)									
LFBR 100 F7	8530	100	204	204	400	480	3.5	ELFBR 100 F7	8300
LFBR 125 F7	8531	125	204	204	400	480	3.5	ELFBR 125 F7	8301
LFBR 160 F7	8532	160	294	295	400	480	4.3	ELFBR 160 F7	8302
LFBR 200 F7	8533	200	294	295	400	480	4.3	ELFBR 200 F7	8303
LFBR 250 F7	8534	250	424	385	480	600	5.2	ELFBR 250 F7	8304
LFBR 315 F7	8535	315	424	385	480	600	5.2	ELFBR 315 F7	8305
LFBR 355 F7	8536	355	504	505	600	720	6.6	ELFBR 355 F7	8306
LFBR 400 F7	8537	400	504	505	600	720	6.6	ELFBR 400 F7	8307

EHR-K



Dim. in mm see table

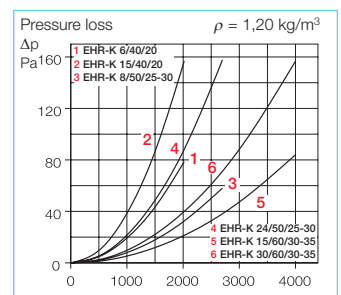
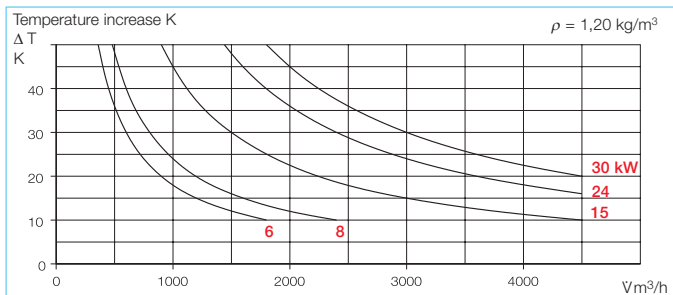
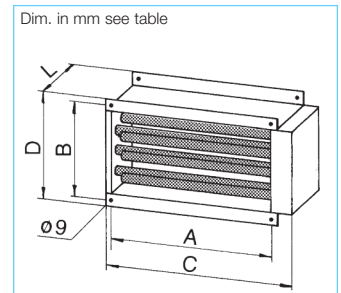

Electric heater battery EHR-K
 Heating elements enclosed in a galvanised casing with MEZ flanges on both sides for in-duct installation.

Heating elements with low surface temperature are individually wired to the outer terminal box and coils can be wired in several groups.

Equipped with a thermal switch which opens at 90 °C and re-sets itself after cooling down. The other thermal switch opens at 120 °C and must be reset manually.

Note

DIN VDE 0100-420 must be observed on site; a proper air flow monitoring and electrical interlocking shall be provided.

Installation

The heater must be installed downstream of the fan. If installing it before the fan, make sure that the air flow temperature at the fan does not exceed the fan's maximum temperature. A rectangular duct with a length of at least 1 metre must be installed between fan and heater. The heater should not be used below the minimum air flow volume of the heater battery. The electrical connection must be interlocked so that the heater cannot operate if the fan is not running. If the thermal switch releases, the heater battery must cut off automatically. The coils can be wired in groups so that the heat output can be reduced arbitrarily.

Selection and operation

The heater batteries generate an additional resistance that must be considered when designing the system. The temperature increase depends on air flow volume and heat output (see diagrams above). In order to prevent an unwanted thermal cut out, the air flow volume must be higher than the minimum figure shown in the chart.

Accessories

Accessories	Page
Electronic temperature control system EHS	427

Accessories

Electronic temperature control system

Type EHS see table below
 Controls the heat output of the heating element by monitoring difference between the supply air temperature and the required temperature.

Duct sensor (accessory for EHS)

Type TFK Ref. no. 5005
 Temperature sensor for detecting the air temperature in ducting.

Room sensor (accessory for EHS)

Type TFR Ref. no. 5006
 Temperature sensor with integrated "desired value encoder" for surface mounting. Can also be used as temperature sensor or as desired value encoder only.

Type	Ref. no.	Motor power kW	Switching groups no. x kW	Current A	Minimum air flow volume m³/h	fits rectangular fan nom. size cm	Wiring diagram ¹⁾ no.	Dimensions in mm					Weight approx. kg	Suitable temperature control system	
								A	B	C	D	L		Type	Ref. no.
3-, 400															
EHR-K	6/40/20	8702	6 2 x 3	8.7	430	40/20	361.4	423	223	550	250	200	7.3	EHS 16	5003
EHR-K	15/40/20	8703	15 5 x 3	21.7	430	40/20	366.4	423	223	550	250	320	13.3	EHS 16	5003
EHR-K	8/50/25-30	8704	8 2 x 4	11.3	680	50/25-30	362.4	523	273/323	650	350	200	9.2	EHS 16	5003
EHR-K	24/50/25-30	8705	24 6 x 4	33.9	680	50/25-30	364.4	523	273/323	650	350	250	17.2	EHS 30	5004
EHR-K	15/60/30-35	8706	15 3 x 5	20.9	980	60/30-35	365.4	623	323/373	750	400	200	12.9	EHS 16	5003
EHR-K	30/60/30-35	8707	30 6 x 5	41.7	980	60/30-35	363.4	623	323/373	750	400	200	19.3	EHS 30	5004

¹⁾ Principal wiring for all types no. 476.2

Electric heater battery EHR-R

Heating elements with low surface temperature made of stainless high-grade steel and are totally enclosed in a galvanised casing with terminal box for commercial in-duct installations.

Equipped with a thermal switch which opens at 50 °C and re-sets itself after cooling down. The other thermal switch opens at 120 °C and must be reset manually.

Installation

The heater must be installed downstream of the fan. If installing it before the fan, make sure that the air flow temperature at the fan does not exceed the fan's maximum temperature. A circular duct with a length of at least 1 metre must be installed between fan and heater. The heater should not be used below the minimum air flow volume of the heater battery. The electrical connection must be interlocked so that the heater cannot operate if the fan is not running. If the thermal switch releases, the heater battery must cut off automatically. The coils can be wired in groups so that the heat output can be reduced arbitrarily.

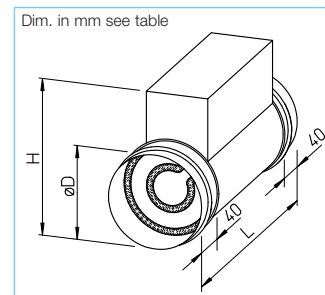
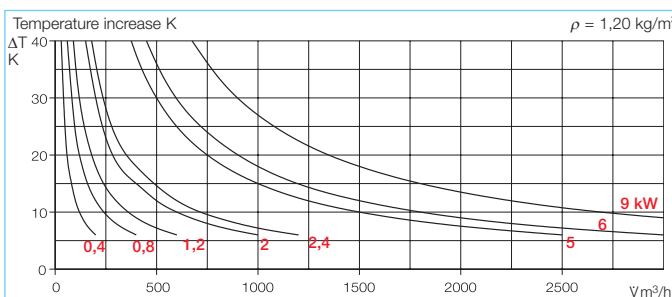

Selection and operation

The heater batteries generate an additional resistance that must be considered when designing the system.

The temperature increase depends on air flow volume and heat output (see diagrams above). In order to prevent an unwanted thermal cut out, the air flow volume must be higher than the minimum figure shown in the chart.

Accessories

Electronic temperature control system

Type EHS see table below
Controls the heat output of the heating element by monitoring difference between the supply air temperature and the required temperature.

Duct sensor (accessory for EHS)

Type TFK Ref. no. 5005
Temperature sensor for detecting the air temperature in ducting.

Room sensor (accessory for EHS)

Type TFR Ref. no. 5006
Temperature sensor with integrated "desired value encoder" for surface mounting. Can also be used as temperature sensor or as desired value encoder only.

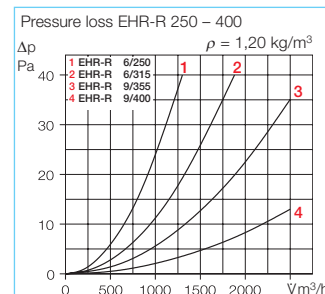
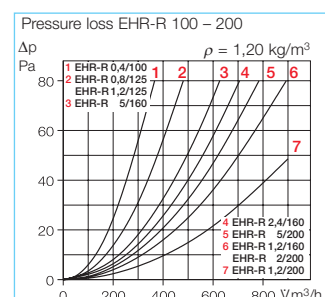

Type	Ref. no.	Motor power	Switching groups no.	Current	Minimum air flow volume	Fits fan nominal size	Wiring diagram ¹⁾	Dimensions			Weight approx.	Suitable temperature control system	
		kW	x kW	A	m³/h	mm	No.	Ø D	H	L	kg	Type	Ref. no.
1-, 230 V													
EHR-R 0,4/100	8708	0.4	1 x 0.4	1.7	45	100	813	100	185	325	2.0	EHS	5002
EHR-R 0,8/125	8709	0.8	1 x 0.8	3.5	70	125	813	125	225	325	2.3	EHS	5002
EHR-R 1,2/125	9433	1.2	1 x 1.2	5.2	70	125	813	125	225	325	2.4	EHS	5002
EHR-R 1,2/160	9434	1.2	1 x 1.2	5.2	110	160	813	160	260	380	2.6	EHS	5002
EHR-R 2,4/160	9435	2.4	1 x 2.4	10.4	110	160	814	160	260	380	3.0	EHS	5002
EHR-R 1,2/200	9436	1.2	1 x 1.2	5.2	180	200	813	200	300	380	2.8	EHS	5002
EHR-R 2/200	9437	2.0	1 x 2.0	8.7	180	200	813	200	300	380	3.2	EHS	5002
2-, 400 V													
EHR-R 5/160	8710	5.0	1 x 5.0 parallel	12.5	110	160	815	160	260	380	4.0	EHS	5002
EHR-R 5/200	8711	5.0	1 x 5.0 parallel	12.5	180	200	815	200	300	380	4.6	EHS	5002
EHR-R 6/250	8712	6.0	1 x 6.0 parallel	15.0	270	250	815	250	350	380	7.3	EHS	5002
EHR-R 6/315	8713	6.0	1 x 6.0 parallel	15.0	420	315	815	315	415	380	9.2	EHS	5002
3-, 400 V													
EHR-R 9/355	8656	9.0	1 x 9.0 im Δ	13.0	550	355	816	355	455	380	12.5	EHSD 16	5003
EHR-R 9/400	8657	9.0	1 x 9.0 im Δ	13.0	680	400	816	400	500	380	13.1	EHSD 16	5003

¹⁾ Principal wiring for all types No. 476.2

Note

DIN VDE 0100-420 must be observed on site; a proper air flow monitoring and electrical interlocking shall be provided.

Accessories Page

Electronic temperature control system EHS 427

■ Electronic temperature control system EHS for electric heater batteries

□ Electronic controller for electric heater batteries installed in circular or rectangular ventilation systems. Controls the heat output of heating element by monitoring the supply air temperature against the required temperature.

■ Continuous control is achieved by a proportional timer which allocates power in time intervals. The relation between on and off time periods is adjusted to the required heat. Switching sequence in compliance with electricity boards can be obtained even with high switching power.

■ Power regulation without contacts through electronic power switch.

■ Control via desired value encoder (internal or external, room sensor TFR) or via remote signal 0 – 10 V DC (only in EHSD models).

■ Application

□ The controllers are designed to maintain a constant supply air temperature and a constant room temperature. With rapid change in supply air temperature the unit first gives a considered response whilst checking whether the change is going to be sustained and then goes to full proportional response. All models feature a night set-back facility which can be activated using a time clock (to be supplied on site externally).

□ For safety reasons an additional air flow sensor is required to monitor the air flow.

Air flow sensor, – electronic

Type SWE Ref. no. 0065
– mechanical, from NW 315

Type SWT Ref. no. 0080
see product page.

EHS



Electronic temperature controller for electric heater batteries up to 3.5 kW (230 V)/6.4 kW (400 V)

Type EHS Ref. no. 5002

Temperature sensitive semi conductor controller. Attractive white polymer casing suitable for wall mounting. Constant supply air or room air control via built-in temperature sensor for temperature detection on installation site.

Switchable on remote duct sensor or room sensor (TFK or TFR, accessory). Automatic detection of supply voltage 230 V 1 ph. or 400 V 2 ph.

Voltage 230 V, 1~ / 400 V, 2~ (automatic detection)
Loading capacity (current) 16 A
Protection to IP 30
Dim. in mm H 153 x W 93 x D 40
Weight approx. 0.3 kg
Wiring diagram no. 531

EHSD



Electronic temperature controller for electric heater batteries up to 17 kW

Type EHSD 16 Ref. no. 5003

Temperature sensitive semi conductor controller. Robust aluminium casing suitable for wall and switchboard mounting. Constant supply air or room air control via external duct sensor or room sensor (TFK/TFKB or TFR, accessory). Remote control via external desired value encoder TFR or external control voltage 0 – 10 V DC.

Voltage 400 V, 3~
Loading capacity (current) 25 A
Protection to IP 40
Dim. in mm H 207 x W 160 x D 95
Weight approx. 1.7 kg
Wiring diagram no. 550.2

■ Other accessories for EHSD

In-duct temperature sensor for limiting functions.
Type TFKB Ref. no. 5009

■ Note

The on-site required system control which corresponds to the wiring diagrams shall be provided.

Electronic temperature controller for electric heater batteries up to 34 kW

Type EHSD 30 Ref. no. 5004

As EHSD 16 but with a maximum output of 34 kW. The total output is split into a controlled output (max. 17 kW) and an uncontrolled basic output (17 kW). If the required power exceeds approx. 17 kW the basic output of 17 kW will be activated permanently via an internal contactor. The remaining output will be temperature controlled.

Voltage 400 V, 3~
Loading capacity (current) 25 A
Protection to IP 40
Dim. in mm H 207 x W 160 x D 95
Weight approx. 1.7 kg
Switch relay Voltage 230 V~
Current max. 5 A
Switch relay Voltage 400 V, 3~
Current max. 25 A
Wiring diagram no. 550.2

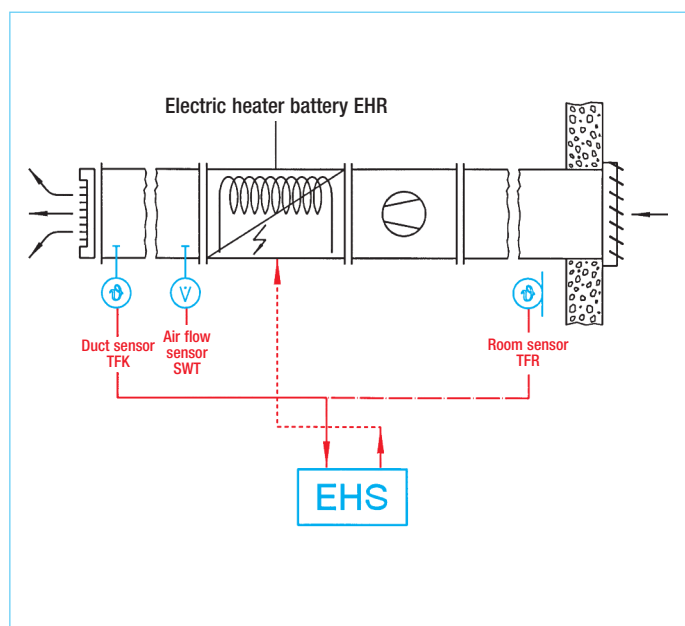

Duct sensor (accessory for EHS)

Type TFK Ref. no. 5005

Temperature sensor to detect the airflow temperature in ducting. Includes mounting plate to fit on duct wall.

Temperature range 0 – 30 °C
Protection to IP 20
Length inner/outer 130 / 50 mm
Ø 10 mm
Weight approx. 0.1 kg



Room sensor (accessory for EHS)

Type TFR Ref. no. 5006

value encoder for surface mounting. Also suitable as desired value encoder or sensor only. Attractive casing made of polymer.

Temperature range 0 – 30 °C
Protection to IP 20
Dim. in mm H 86 x W 86 x D 30
Weight approx. 0.1 kg

EHR-R TR

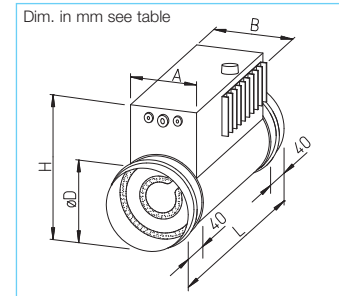

Electric heater battery EHR-R TR with integrated temperature control.
A convenient and easy-to-install solution for all areas where a constant room or supply air temperature is required.
Electric heater batteries EHR-R TR are equipped with an integrated temperature controller and can be mounted in the ducting in any position.
The installation is remarkably easy and space saving.

Heater battery

Enclosed, high-grade stainless steel heating elements with low surface temperature.
Casing with terminal box and integrated temperature controller for installation in commercial ducting systems.
Equipped with an automatically resetting temperature limiter (activation temperature 50 °C) and a manually resettable temperature limiter (activation temperature 120 °C).

Temperature control

- Constant supply air control by connecting a duct sensor (TFK, accessories). Setpoint specification (0 – 30 °C) via potentiometer on outside of unit.
Room air temperature control by connecting a room sensor (TFR, accessories); Optional setpoint specification via room sensor TFR or potentiometer.
Automatic detection of supply voltage 230 V or 400 V.
Load capacity 16 A
Protection class IP 20
- Stepless control is achieved by pulse/pause technology, which allocates power in time intervals. The ratio between on and off time periods is adjusted to the required performance. The max. switching cycles per time unit specified by the electricity suppliers are also observed for large switching applications.

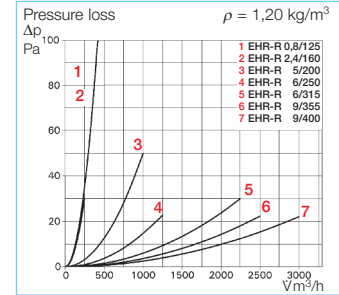
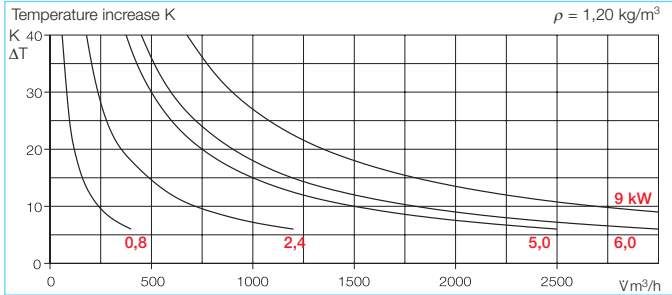

Application

- EHR-R TR are suitable for constant supply air temperature or for constant room temperature control. In case of rapid temperature changes in the supply air, PI control behaviour is achieved; in case of slow changes in room air, the control behaviour corresponds to a P controller.
- Air flow monitoring is required for safety reasons.

Flow monitors

- electronic
Type SWE Ref. no. 0065
 - mechanical, over nom. size 315
Type SWT Ref. no. 0080
- see product page

Installation

See description EHR-R, page 426.

Selection and operation

Heater batteries create additional pressure loss, which must be considered with regard to the dimensioning of the entire system. The temperature increase depends on power output and air flow volume (see diagram on right).
In order to prevent the unintentional disconnection of the temperature monitor, the air flow rate must be higher than the minimum figure (see table).

Accessories

- Duct sensor**
Type TFK Ref. no. 5005
Temperature sensor for detecting the air temperature in ducting.
- Room sensor**
Type TFR Ref. no. 5006
Temperature sensor with integrated setpoint device for surface installation. Also suitable purely as a temperature sensor or setpoint device.

Type	Ref. no.	Power kW	Switch. group no.	Current A	Minimum air flow volume m³/h	fits fan nominal size mm	Wiring diagram No.	Dimensions					Weight approx. kg
								Ø D mm	H mm	L mm	A mm	B mm	
1~, 230 V													
EHR-R 0,8/125 TR	5293	0.8	1 x 0.8	3.5	70	125	799.1	125	225	325	125	145	2.6
EHR-R 2,4/160 TR	5294	2.4	2 x 1.2	10.4	110	160	799.1	160	260	380	150	170	3.4
2~, 400 V													
EHR-R 5/200 TR	5295	5.0	2 x 2.5	12.5	180	200	800.1	200	300	380	150	170	4.4
EHR-R 6/250 TR	5296	6.0	2 x 3.0	15	270	250	800.1	250	350	380	150	170	4.8
EHR-R 6/315 TR	5301	6.0	2 x 3.0	15	420	315	800.1	315	415	380	150	170	6.4
3~, 400 V													
EHR-R 9/355 TR	5297	9.0	3 x 3.0	13	550	355	801.1	355	455	380	150	182	8.5
EHR-R 9/400 TR	5299	9.0	3 x 3.0	13	680	400	801.1	400	500	380	150	182	8.9

Warm water heater battery for rectangular duct connection.

Casing made of galvanised sheet steel, flanges on both sides to fit the Helios rectangular fan range. Air heater with Al fins, with staggered copper ducting. Operating temp. t_{max} 120 °C. Operating pressure max. 8 bar. Water pipes with male thread. Equipped with water and air outlets.

Installation

The heater must be installed downstream of the fan. If installing it before the fan, make sure that the air flow temperature at the fan does not exceed the fan's max. temperature.

To protect the heater from dirt and to prevent it from being clogged (reducing air flow and heat output) we recommend the use of the air filter KLF.

A rectangular duct with a length of at least 1 metre must be installed between fan and heater in order to ensure a balanced air flow. An air bleed valve and a water drain valve must be provided for releasing air and water from the unit.

Attention: Frost protection must be provided on-site.

Selection

The effective temperature increase depends on the variables: Air flow volume, heater output and flow temperature.

This can be determined using the following diagrams (steps a - c). The heater outputs are also specified in the table below for some volume parameters.

When selecting a fan (volume determination), the pressure loss of the heater battery must be considered (section d), which is shown in the diagrams.

a) Temperature increase

Definition: $\Delta T = \vartheta_1 - \vartheta_a$ [K]
 ΔT : Air temperature difference [K]
 ϑ_1 : Air temp., outlet air heater [°C]
 ϑ_a : Air temp., inlet air heater [°C]

WHR Duct

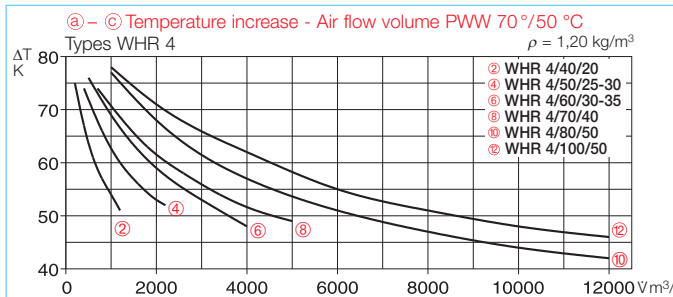
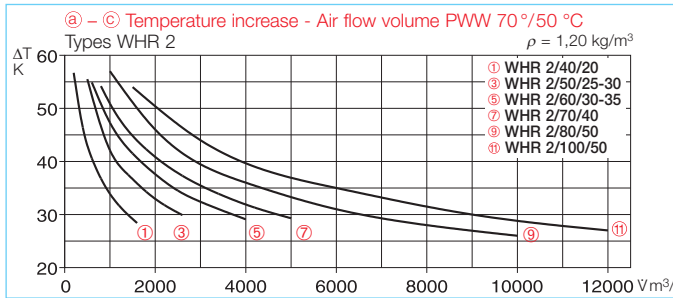
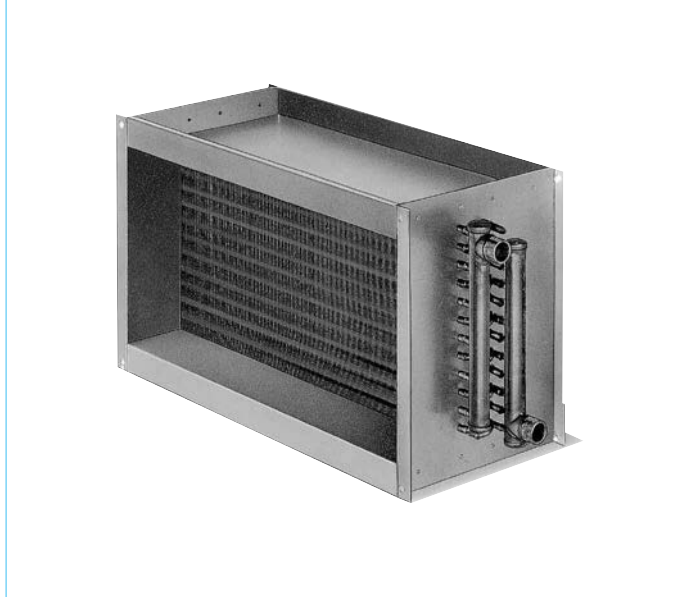

Accessories	Page
Temperature control system WHS HE	432

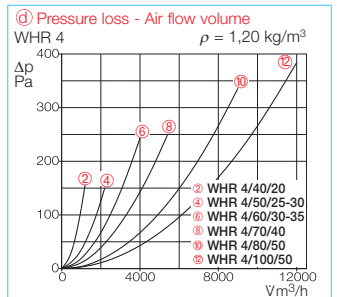
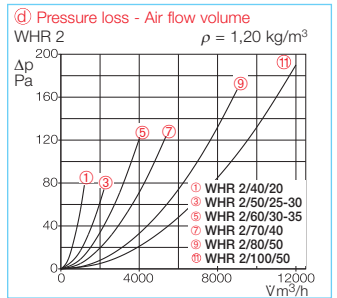
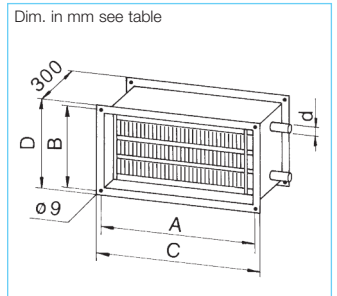

b) Air flow volume

Shown on the performance curve whereby the total resistance of the system and heater pressure loss (section d) must be considered.

c) Determination heat output

$$Q_H = \frac{V \cdot \Delta T \cdot c_{PL} \cdot \rho_L}{3600} \text{ [kW]}$$

V: Air flow volume [m³/h]
 ΔT : Air temperature difference [K]
 c_{PL} : Specific heat capacity of the air (1.0) [kJ/kg K]
 ρ_L : Air density (1.2) [kg/m³]

d) Determination pressure loss

The pressure loss in relation to air flow volume is shown in the diagrams above for the respective heater battery.

Type	Ref. no.	fits fan nominal size	Air data					Water data ¹⁾		Dimensions				Connection d ³⁾	Weight approx.	Suitable temperature control system	
			Heat output		ΔT Air		at V	pressure loss	at water flow rate	A	B	C	D			Type	Ref. no.
		cm	kW ¹⁾	kW ²⁾	K ¹⁾	K ²⁾	m³/h	Δp_w kPa	l/h	mm	mm	mm	mm	Ø"	kg		
WHR 2/40/20	8782	40/20	14	7,7	32	18	1200	10	610	420	220	450	250	3/4	7.0	WHS HE	8319
WHR 4/40/20	8783	40/20	22	12,6	51	29	1200	7	980	420	220	450	250	3/4	7.3	WHS HE	8319
WHR 2/50/25-30	8784	50/25-30	24	14	33	18	2200	7	1050	520	270/320	550	350	3/4	9.3	WHS HE	8319
WHR 4/50/25-30	8785	50/25-30	38	21	52	28	2200	5	1680	520	270/320	550	350	1	11.1	WHS HE	8319
WHR 2/60/30-35	8786	60/30-35	32	18	34	19	2600	8	1420	620	320/370	650	400	3/4	11.2	WHS HE	8319
WHR 4/60/30-35	8787	60/30-35	51	30	55	32	2600	7	2270	620	320/370	650	400	1	14.0	WHS HE ⁴⁾	8319
WHR 2/70/40	8788	70/40	50	28	30	17	4500	6	2200	720	420	750	450	1	17.0	WHS HE	8319
WHR 4/70/40	8789	70/40	81	44	50	27	4500	4	3570	720	420	750	450	1	17.0	—	—
WHR 2/80/50	8795	80/50	82	46	28	16	8000	11	3630	820	520	850	550	1	15.0	—	—
WHR 4/80/50	8796	80/50	138	80	48	28	8000	15	6110	820	520	850	550	1	20.0	—	—
WHR 2/100/50	8797	100/50	104	59	29	18	10000	19	4630	1020	520	1050	550	1	18.0	—	—
WHR 4/100/50	8798	100/50	172	99	48	28	10000	14	7640	1020	520	1050	550	1	24.0	—	—

The values apply for supply air temp. 0 °C and flow/return temperatures: 1) 90/70 °C, 2) 60/40 °C

3) 3/4" = 19.05 mm, 1" = 25.4 mm, male thread

4) for reduced heat output to approx. 2200 l/h

Warm water heater battery for installation in ducting.

Casing made of galvanised sheet steel, fits the Helios rectangular fan range. Spigots have double lip rubber seals on both sides to fit the nominal duct size. Air heater with Al fins moulded to copper ducting.

Operating temp. t_{max} 100 °C.
Operating pressure max. 8 bar.
Water connection pipe with male thread. Two inspection openings on water connection side for easy cleaning. With drain/vent valve.

Installation

The heater must be installed downstream of the fan. If installing it before the fan, make sure that the air flow temperature at the fan does not exceed the fan's max. temperature.

To protect the heater from dirt and to prevent it from being clogged, we recommend the use of the air filter KLF.

A circular duct with a length of at least 1 metre must be installed between fan and heater in order to ensure a balanced air flow. An air bleed valve and a water drain valve must be provided for releasing air and water from the unit.

Attention: Frost protection must be provided on-site.

Selection

The effective temperature increase depends on the variables: Air flow volume, heater output and flow temperature.

This can be determined using the following diagrams (steps a-c). The heater outputs are also specified in the table below for some volume parameters.

When selecting a fan (volume determination), the pressure loss of the heater battery must be considered (section d), which is shown in the diagrams.

WHR Duct



Accessories	Page
Temperature control systems WHST, WHS HE	431 on

Dim. in mm see tables

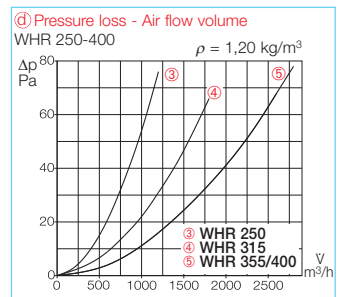
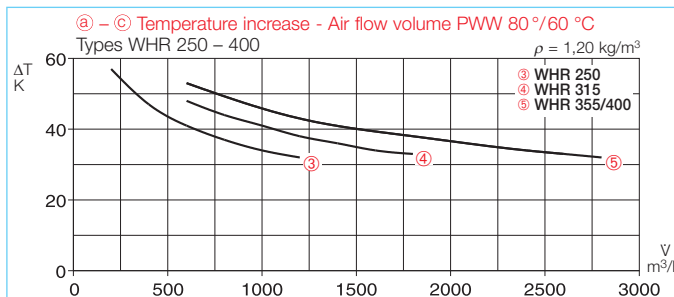
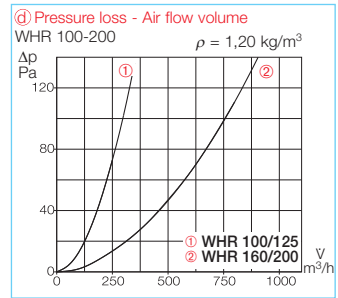
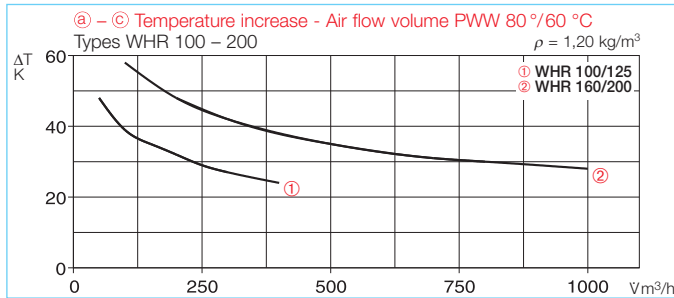
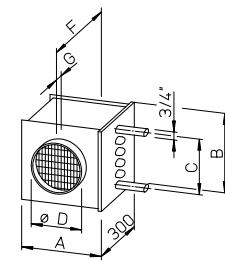

a) Temperature increase

Definition: $\Delta T = \vartheta_i - \vartheta_a$ [K]
 ΔT : Air temperature difference [K]
 ϑ_i : Air temp., outlet air heater [°C]
 ϑ_a : Air temp., inlet air heater [°C]

b) Air flow volume

Shown on the performance curve whereby the total resistance of the system and heater pressure loss (section a) must be considered.

c) Determination heat output

$$Q_H = \frac{V \cdot \Delta T \cdot c_{PL} \cdot \rho_L}{3600} \text{ [kW]}$$

V: Air flow volume [m³/h]
 ΔT : Air temperature difference [K]
 c_{PL} : Specific heat capacity of the air (1.0) [kJ/kg K]
 ρ_L : Air density (1.2) [kg/m³]

d) Determination pressure loss

The pressure loss in relation to air flow volume is shown in the diagrams above for the respective heater battery.

Type	Ref. no.	fits duct diameters	Air data				Water data ¹⁾		Dimensions						Connection d" ³⁾	Weight approx. kg	suitable temperature control system		
			Heat output		ΔT Air		at V	Pressure loss	at water flow rate	A	B	C	$\varnothing D$	G			F	Type	Ref. no.
		\varnothing mm	kW ¹⁾	kW ²⁾	K ¹⁾	K ²⁾	m³/h	Δp_w kPa	l/h	mm	mm	mm	mm	mm	mm		kg		
WHR 100	9479	100	1.9	0.9	35	17	150	1	84	161	180	140	100	45	387	3/4	3.2	WHST 300 T38 ⁴⁾	8817
WHR 125	9480	125	2.6	1.1	29	13	250	2	115	161	180	140	125	45	387	3/4	3.2	WHST 300 T38 ⁴⁾	8817
WHR 160	9481	160	5.5	3.1	38	22	400	11	245	236	255	215	160	45	387	3/4	4.9	WHST 300 T38 ⁴⁾	8817
WHR 200	9482	200	7.2	4.1	33	19	600	17	317	236	255	215	200	45	387	3/4	4.9	WHST 300 T38 ⁴⁾	8817
WHR 250	9483	250	10.7	6	37	21	800	8	470	311	330	290	250	65	427	3/4	6.9	WHS HE	8319
WHR 315	9484	315	18.3	10.4	36.2	21	1400	9	810	396	405	365	315	56	410	3/4	9.0	WHS HE	8319
WHR 355	8790	355	24.5	14	38	21.6	1800	9	1080	461	480	420	355	56	410	3/4	12.5	WHS HE	8319
WHR 400	9524	400	26.2	15	36	21	2000	11	1060	461	480	420	400	66	430	3/4	12.5	WHS HE	8319

The values apply for supply air temp. 0 °C and flow/return temperatures: 1) 90/70 °C 2) 60/40 °C 3) 3/4" = 19.05 mm, 1" = 25.4 mm, male thread 4) alternative WHST 300 T50, see page 137 (Ref. no. 8820)

WHST 300 T38



Note

Air temperature control for warm water heater batteries WHR. For constant supply air temperature between 20 – 50 °C, we recommend **Type WHST 300 T50** (see page 137) Ref. no. 8820

Air temperature control WHST 300 T38 for warm water heater batteries

- To control air heating of the warm water heater batteries for lower output to 5.5 kW and flow rate to 300 l/h.
- An ideal supplement for ventilation units with heat recovery and PWW auxiliary heating, as well as for warm water heater batteries WHR 100 to WHR 200.
- A simple, cost effective and easy-to-install solution.

Specification / Application

WHST 300 T38 consists of a thermostat with remote control and remote sensor and is suitable for systems in which the water pressure of the heating circuit can provide this application.

The proportional controller, which operates as a conventional heating valve without electrical supply energy, is continuously adjustable and changes the temperature through variation of hot water flows.

Control options

Control options through modification of the hot water flow:

- **Constant supply air temperature control** by positioning the capillary tube sensor in the air flow.

Constant room temperature control

by positioning the capillary tube sensor in the room.

Arbitrary limitation of the temperature range

by defining the minimum and maximum values.

Frost protection

activated at +8 °C.

Product contents

- Complete set, including
- Thermostat for room installation,
 - Straight way valve
 - Set piston
 - Capillary tube remote sensor
 - Fittings

Installation

The capillary tube must be located in a position so that it is not buckled or flattened. To keep the room temperature constant the remote sensor

should be installed in the room where the predetermined temperature conditions are present.

Design

The WHST 300 T38 control can be used in heater batteries up to 300 l/h water flow rate. The pressure drop, which must be overcome by an on site pump, appears as the sum of Δp heater battery Δp valve (see diagram) and Δp ducting.

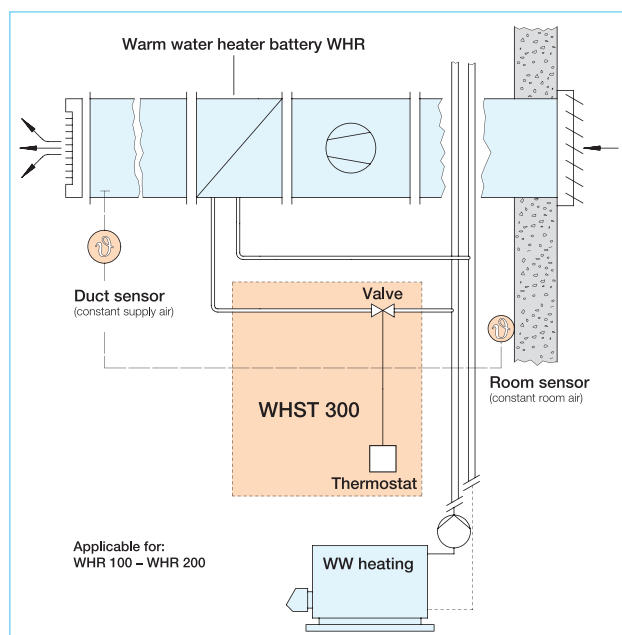

Technical data

Type	WHST 300 T38
Ref. no.	8817
Max. operating pressure	10 bar
Max. operating temperature	120 °C
Connection DN 20	3/4"
Max. air flow	300 l/h
Differential pressure	0.4 K / 0.5 bar
Setpoint range (Thermostat)	8–38 °C
Dimensions in mm	
– Thermostat	W 80 x H 80 x D 50
– Remote sensor	W 35 x H 85 x D 30
Mounting thread DN 20	G 3/4"
Capillary tube length	5 m
Weight (complete)	0.5 kg

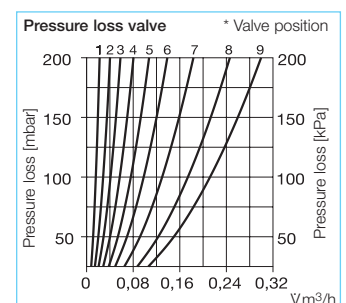

* Note: The valve is factory-adjusted to position 9. For lower volumes of water it can be adjusted between 1 and 9 in order to optimise the control mode.

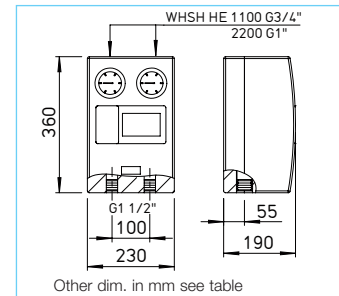

- **Air temperature controller WHS HE for warm water heater batteries**
- To control air heating of the warm water heater batteries for a maximum output of 70 kW and a flow rate of between 200 and 2200 l/h.
- Fits to Helios heater batteries WHR-R 250 – 400 and WHR-K up to 2200 l/h.
- Complete system with various control options where all the components are compatible with each other.

■ **Application**

- Connection on existing heating circuit to supply e.g. a separate cord. A separate heating circuit creation is achieved by means of an integrated pump.
- The hydraulic component WSH HE 24 V is used to operate heating circuit in connection with Helios warm water heater batteries. The flow temperature to the heater battery is controlled using a 3-way-valve, which is operated by an electric servo motor 24 V.
- Delivered as a fully wired and easy-to-install set with pre-installed, thermally insulated hydraulic unit.

■ **Control options**

- Constant supply air temperature control by means of duct sensor TFK.
- Constant room temperature control by means of external room sensor TFR.
- Constant room temperature control with minimum limitation of the supply temperature through use of room and duct sensors.
- Frost protection for all the three versions by using a second duct sensor TFK.
- WHS HE also offers the possibility of setpoint control e.g. for night and weekend cutout as well as the connection of other sensors or setpoint devices.

■ **Scope of delivery / Specification**

- Hydraulic unit WSH HE 24 V with
 - Electronic circulating pump with automatic ventilation function, 2 m connection cable.
 - Flow/return stop valve with integrated temperature display.
 - 24 V servo motor with limit switch, manual operation possible. Connection cable (2.2 m).
 - Three-way-valve.
 - Thermal jacket made of EPP foam.
 - Gasket set and two flexible hoses DN 25 (stainless steel, 50 cm long) for battery-side connection.
 - Reducer nipple, 3/4" – 1".

- Electronic control unit WHSE, for installation in switch cabinet. Functions:
 - Pre-set temperature specification for operation with constant supply air temperature.
 - Adjustment of cascade factors.
 - Minimum limitation.
 - Adjustment/selection of the control mode.
 - Operating display.
 - Frost protection: alarm and reset.
 - Operating display servo motor.
 - Potential-free output for alarm 24 V and 230 V circuit.
- Two temperature sensors TFK for in-duct installation.
- One room temperature sensor TFR.

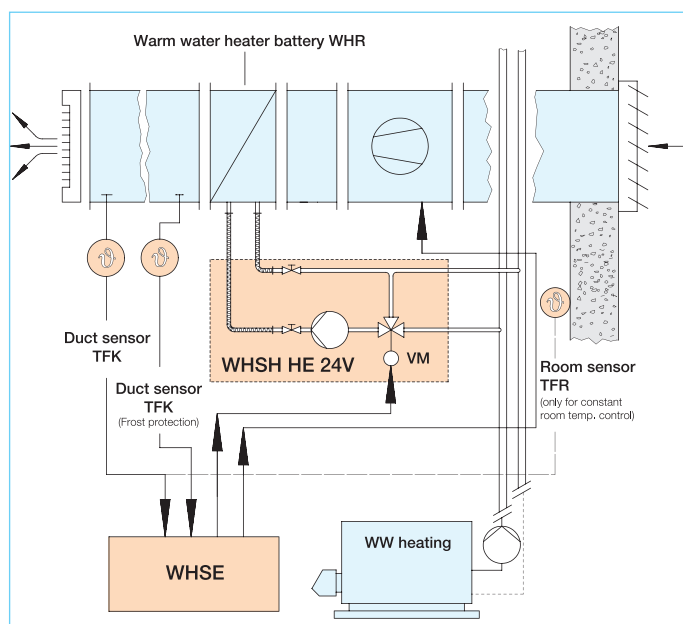

Type	WHS HE
Ref. no.	8319
Max. operating pressure	6 bar
Max. operating temperature	120 °C
KVS value	5.1
Min. / Max. air flow	200 ¹⁾ – 2200 l/h
Differential pressure	0.1 – 0.7 K / 0.5 bar
Setpoint range (Thermostat)	7 – 28 °C
Ambient temperature (electronic control system)	0 – 50 °C
Protection class (electronic control system)	IP 20
Power consumption – Pump	3 ... 45 W
– Servo motor	2.5 W
– Electronic control system	5 W
Voltage – Pump / electronic control system	230– V / 50 Hz
– Servo motor	24– V / 50/60 Hz
Wiring diagram no.	953
Dim. in mm – Hydraulic unit ³⁾	see dimensional drawing
– Electronic control system WHSE ³⁾	H 80 x W 100 x D 85
– Room sensor TFR	H 80 x W 85 x D 30
– Duct sensor TFK	130/50 ²⁾ , Ø 10
Weight approx. kg	9.0

¹⁾ Control problems may occur at lower water flow volumes
³⁾ Single order of WHS HE system components by request.

²⁾ Length inside/outside

Installation

The heater battery WHR and the duct sensor TFK must be installed downstream of the fan in ducting.
The hydraulic unit WSH HE 24 V must be fixed independently and safely.
The expansion forces or the dead weight of ducting must not burden the connections.
The exhaust valve shall be installed at the highest position whereas the drain valve shall be installed at the lowest position of the circuit.
The electronic control unit WHSE (IP 20) can be mounted on the DIN-profile rail in the switch cabinet.

Application example

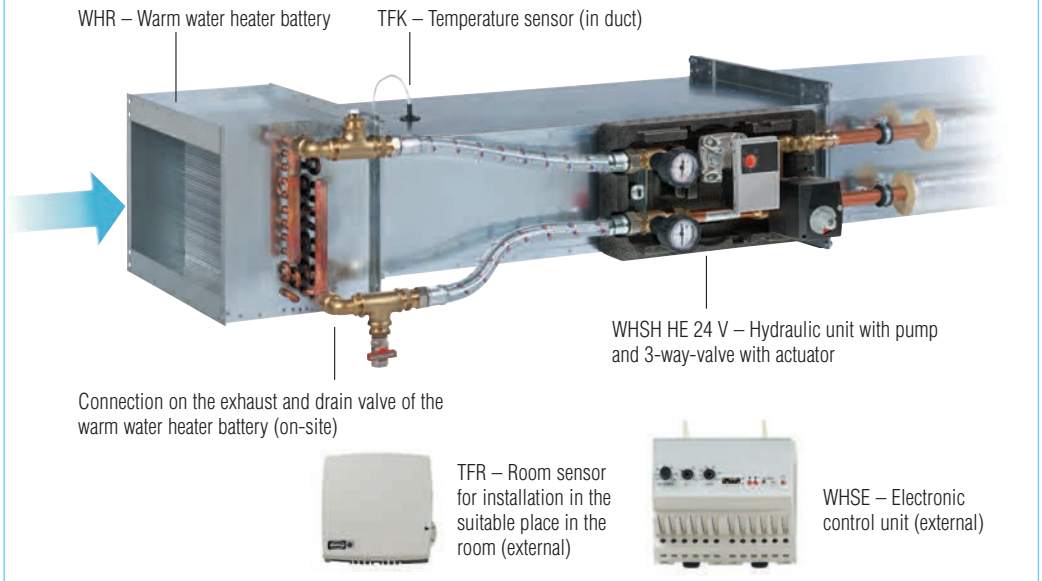

Design

- ① Selection of the requested PWW heater batteries based on the air flow volume, design (duct dimensions) and required heat output.
 - WHR-R, circular p. 430
 - WHR-K, rectangular p. 429
- ② Determination of pressure loss of the on-site ducting system.
- ③ Sum of losses of all components:
 - $\Delta p_{total} =$
 - $\Delta p_{heater\ battery}$
 - $+ \Delta p_{ducting\ system}$
 - $+ \Delta p_{WSH\ HE}$
- ④ Adjustment of required differential pressure Δp_{total} on circulating pump control knob.

Diagram

Pressure loss hydraulic unit incl. flexduct

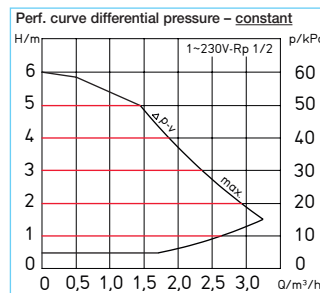
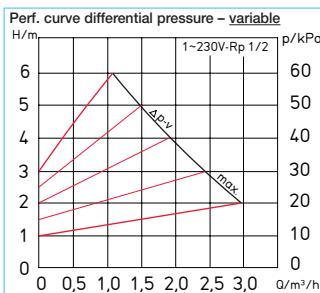
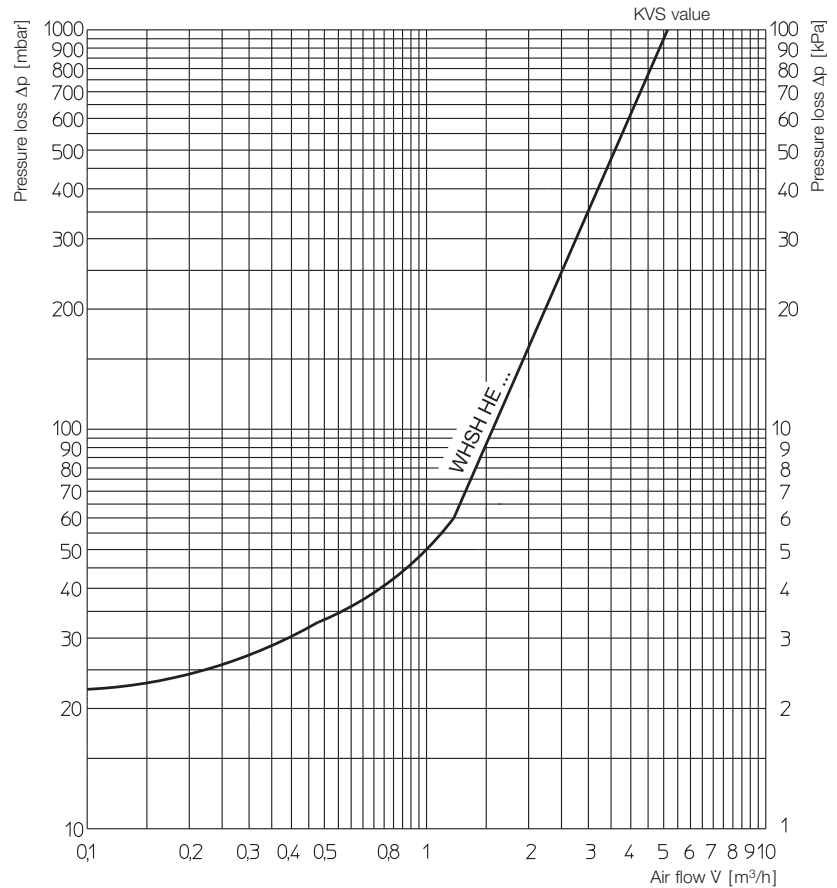

Information Page

Other WSH hydraulic units

- for KWL® units **137**
with PWW auxiliary heating
WSH HE 24 V (0-10V) No. 8318
- for ALB WW **291** on
WSH HE 24 V (0-10V) No. 8318

■ General information

If the noise emissions of a fan exceed the permitted level, passive measures must be taken to reduce noise. The use of attenuators according to the absorption principle is a good option here. This type of attenuator guarantees noise insulation with low pressure losses.

Helios offers attenuators that are perfectly suited to Helios fans. Pipeline and duct attenuators with corresponding housing forms are available. Of course, all types of attenuators can also be used with fans from other companies.

Helios attenuators have a coating of galvanised sheet steel and splitters of high-quality mineral wool, which are covered from the air flow by abrasion-resistant fleece.

■ Technical information Sound absorption

The benchmark for sound absorption is the insertion attenuation according to DIN EN ISO 14163. It constitutes the sound level reduction in a pipeline or duct section with and without an attenuator calculated by way of a comparative measurement.

When performing the measurement without an attenuator, an acoustically hard spacer is used in its place. Thus the insertion attenuation is calculated:

$$D_e = L_o - L_m \text{ dB}$$

L_o : Level without attenuator
 L_m : Level with attenuator

However, as the effectiveness of an attenuator is heavily dependent on the frequency, the insertion attenuation is stated as a function of the frequency range. The insulation of low-frequency noise requires a greater damper volume than the insulation of higher-frequency noise and is therefore associated with greater effort.

For this reason, knowledge of the noise spectrum (octave and one-third octave spectrum) of the fan is necessary when selecting an attenuator. When performing an acoustic assessment of a ventilation system, it should be noted that other system components, such as manifolds, changing cross sections and branches, also have a sound-insulating effect.

More exact information on this is found in the VDI Directive 2081 – Sound generation and noise reduction in air conditioning systems.

The lower limit of the sound emissions of a system is formed by the generation of flow noise in the attenuator and system components. These are amplified considerably as the flow rate increases. Therefore the flow rates should be kept as low as possible.

■ Quick selection of an attenuator

An average insulation value is stated in the type table (column with the red background on the far right) for a quick selection of pipeline and duct attenuators. This value is to be deducted from the sound power level (L_{WA} total) of the fan. As a result, you get the sound power level of the fan reduced by the noise insulation (L_{WA} reduced).

This method of selection, which is different to the frequency band calculation, is based on rounding. A calculation according to the octave (see adjacent example) produces more accurate values.

■ Example: Available:

Fan type VARD 225/2
Selected: Duct insulator RSD 225/600 (construction length = 600 mm)

Sound power level of the fan
 L_{WA} total = 81 dB(A)

Average sound absorption of the attenuator
minus = 15 dB(A)

= Reduced sound power level
 L_{WA} reduced = 66 dB(A)

■ Designations

L_{WA} total = sound power level of the fan in dB(A) (from the table above the set of characteristic curves).

Average insulation value = derived damping capacity of the attenuator in dB(A) (from the column with the red background of the attenuator type table).

L_{WA} reduced = sound power level in dB(A) reduced by the use of an attenuator.

■ Sound level calculation

To determine the sound level after using an attenuator, the insertion attenuation is to be deducted from the level of the band of the fan using the frequency band and the total sound level calculated from this. As a rule, this is done in octaves. For larger insertion attenuations, multiple attenuators with the same diameter may be arranged one after another. The example below explains the method. Task at hand: Reducing the noise from a fan type VARD 225/2 (2800 min⁻¹) using a RSD 225/600 attenuator (basic length 2).

	Octave medium frequency Hz							
	125	250	500	1000	2000	4000	8000	
A-weighted octave level $L_{WA, Okt}$ of fan VARD 225/2	51	62	74	76	76	72	63	dB(A)
A-weighted total sound power level L_{WA}	$L_{WA} = 81 \text{ dB(A)}$							
Insertion insulation level of the attenuator D_e RSD 225/600 (2 x basic length)	4	10	17	27	25	17	14	dB
A-weighted octave level $L_{WA, Okt}$ of fan with attenuator	47	52	57	49	51	55	49	dB(A)
A-weighted total sound power level L_{WA}^* of the fan with attenuator	$L_{WA}^* = 10 \cdot \lg(10^{47 \cdot 0.1} + 10^{52 \cdot 0.1} + 10^{57 \cdot 0.1} + 10^{49 \cdot 0.1} + 10^{51 \cdot 0.1} + 10^{55 \cdot 0.1} + 10^{49 \cdot 0.1}) = 61 \text{ dB(A)}$							
Relevant A-weighted sound pressure level at 1 m distance	$L_{pA}^* = 53 \text{ dB(A)}$							

Rectangular attenuator KSD

Design – Installation

Casing made from galvanised sheet steel, with flanges to fit the fan dimensions, door installation in-line with the ducting inlet or outlet. In order to reduce structure-borne sound transmission, a flexible connector (VS or VS Ex) should be installed between fan/attenuator and ducting.

Pressure loss

The attenuator will add an additional resistance to the duct system (see diagram), which must be considered when selecting a fan. These values apply for equal inflows. In case of unequal flow (e.g. rectangular fan outflow), a 1 metre section of straight ducting can be fitted between fan and attenuator or allow for higher resistance.

KSD

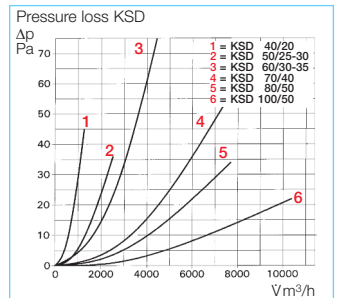
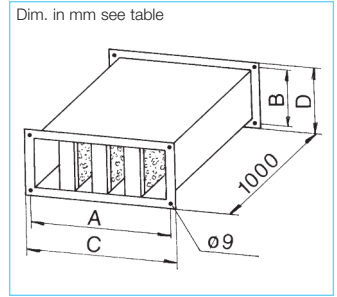

Information	Page
Selection acoustic calculation	434

Type	Ref. no.	Duct size in cm	No. inserts	Dimensions in mm				Weight approx. kg	Insertion insulation level D_e dB at Hz				average insulation			
				A	B	C	D		125	250	500	1000		2000	4000	8000
KSD 40/20	8728	40/20	3	420	220	443	240	13	8	11	23	31	31	26	18	17
KSD 50/25-30	8729	50/25-30	3	520	270/320	540	340	16.5	6	9	19	25	25	20	15	14
KSD 60/30-35	8730	60/30-35	4	620	320/370	640	390	20	7	10	21	28	28	23	16	12
KSD 70/40	8731	70/40	4	720	420	740	440	25	6	8	18	24	24	20	14	12
KSD 80/50	8732	80/50	5	820	520	840	540	31	7	9	19	26	26	21	15	14
KSD 100/50	8733	100/50	5	1020	520	1040	540	35	5	7	16	21	21	17	12	11

Flexible circular attenuator FSD

Design – Installation

Robust flexible aluminium ducting with inner perforated face retaining the resin bounded attenuation packing of 50 mm thickness. Spigotted on both ends to fit into nominal size ducting or to be fixed with pipe clamp connectors BM on fan or ducting. The flexible body allows easy installation.

Pressure loss

The pressure loss is 4 times the friction resistance.

FSD

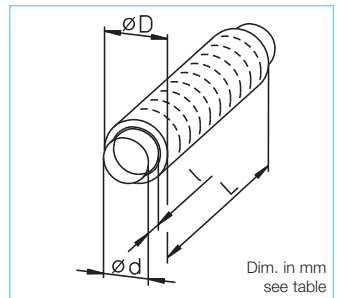

Information	Page
Selection acoustic calculation	434

Type	Ref. no.	L	Dimensions in mm			Insertion insulation level dB at Hz				Weight approx. kg	average insulation
			$\varnothing D$	$\varnothing d$	l	250	500	1000	2000		
FSD 100	0676	1000	210	99,5	60	17	33	48	40	1.1	25
FSD 125	0677	1000	240	124,5	60	13	27	47	22	1.5	20
FSD 160	0678	1000	262	159,5	60	12	26	45	20	2.0	19
FSD 200	0679	1000	313	199,5	60	10	22	31	10	2.5	16
FSD 250	0680	1000	363	249,5	85	8	15	26	8	3.2	12
FSD 315	0681	1000	418	314,5	85	7	15	25	8	4.2	11
FSD 355	0682	1000	464	354,5	85	5	13	19	8	4.7	9
FSD 400	0683	1000	514	399,5	90	5	13	19	8	5.3	9

■ Design – Installation

Casing made of galvanised sheet steel. Cladding with high-quality mineral wool covered with fleece to prevent abrasion. Dimensions and fixing holes of all sizes fit the nominal diameter of the fan (R 20). Fixing holes according to DIN 24155, Pt. 2.

■ Insertion insulation

For larger insertion insulation, several attenuators with the same diameter can be installed in-line.

■ Pressure loss

The resistance of the RSD attenuators is very low. When designing the system, twice the friction resistance should be into account.

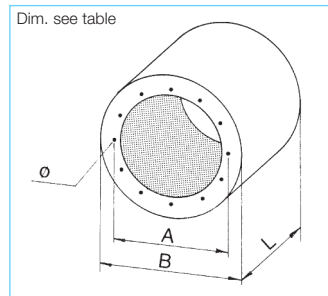

Information	Page
Selection acoustic calculation	434

Type Nominal Ø	Ref. no	Basic length	L	Dimensions in mm			Hole Ø	Weight approx. kg	Insertion insulation level D _e dB								average insulation
				A	B				125	250	500	1000	2000	4000	8000		
RSD 225/ 300	8734	1	300	259	404		6 x M 6	7	2	5	9	14	13	8	6	8	
RSD 225/ 600	8735	2	600	259	404		6 x M 6	12	4	10	17	27	25	17	14	15	
RSD 225/ 900	8736	3	900	259	404		6 x M 6	17	7	13	25	33	31	20	16	20	
RSD 250/ 300	8737	1	300	286	404		6 x M 6	7	3	5	8	8	9	7	5	8	
RSD 250/ 600	8738	2	600	286	404		6 x M 6	12	5	10	16	24	19	14	10	15	
RSD 250/ 900	8739	3	900	286	404		6 x M 6	16	6	12	22	28	21	15	11	18	
RSD 280/ 400	8740	1	400	322	454		8 x M 8	10	4	5	8	14	9	8	6	8	
RSD 280/ 800	8741	2	800	322	454		8 x M 8	18	7	9	16	28	18	17	14	14	
RSD 280/1200	8742	3	1200	322	454		8 x M 8	25	9	12	23	37	23	20	16	18	
RSD 315/ 400	8743	1	400	356	504		8 x M 8	11	3	3	7	13	8	7	5	5	
RSD 315/ 800	8744	2	800	356	504		8 x M 8	19	6	8	14	26	16	12	9	12	
RSD 315/1200	8745	3	1200	356	504		8 x M 8	28	9	12	21	36	18	17	14	18	
RSD 355/ 400	8746	1	400	395	564		8 x M 8	13	3	4	7	11	7	6	4	6	
RSD 355/ 800	8747	2	800	395	564		8 x M 8	23	6	7	13	22	14	12	8	11	
RSD 355/1200	8748	3	1200	395	564		8 x M 8	33	8	11	17	29	18	15	10	17	
RSD 400/ 400	8749	1	400	438	564		12 x M 8	12	3	4	6	9	7	5	3	6	
RSD 400/ 800	8750	2	800	438	564		12 x M 8	21	6	6	12	18	13	12	8	9	
RSD 400/1200	8751	3	1200	438	564		12 x M 8	30	7	10	14	22	18	13	9	15	
RSD 450/ 400	8752	1	400	487	634		12 x M 8	17	4	5	8	10	8	7	5	8	
RSD 450/ 800	8753	2	800	487	634		12 x M 8	27	6	7	13	18	13	12	9	11	
RSD 450/1200	8754	3	1200	487	634		12 x M 8	38	8	10	18	23	17	14	10	15	
RSD 500/ 600	8755	1	600	541	714		12 x M 8	27	4	5	9	11	9	9	6	8	
RSD 500/ 900	8756	2	900	541	714		12 x M 8	36	6	8	14	16	13	13	9	12	
RSD 500/1200	8757	3	1200	541	714		12 x M 8	45	8	11	22	24	17	16	12	17	
RSD 560/ 600	8758	1	600	605	804		8 x M 10	32	3	5	9	9	8	8	6	8	
RSD 560/1200	8759	2	1200	605	804		8 x M 10	52	6	10	19	19	16	13	10	15	
RSD 630/ 600	8760	1	600	674	900		8 x M 10	44	3	5	8	8	8	7	5	8	
RSD 630/1200	8761	2	1200	674	900		8 x M 10	68	5	10	16	15	15	11	8	15	
RSD 710/ 600	8762	1	600	751	1000		8 x M 10	51	3	5	7	7	7	6	4	8	
RSD 710/1200	8763	2	1200	751	1000		8 x M 10	80	5	10	14	13	13	10	7	15	
RSD 800/ 600	8764	1	600	837	1100		12 x M 10	57	2	5	7	6	6	5	4	8	
RSD 800/1200	8765	2	1200	837	1100		12 x M 10	88	5	9	13	11	11	9	6	14	
RSD 900/ 900	8766	1	900	934	1220		12 x M 10	82	2	4	10	9	6	5	4	6	
RSD 900/1800	8767	2	1800	934	1220		12 x M 10	135	4	9	21	17	13	9	8	14	
RSD 1000/ 900	8768	1	900	1043	1350		12 x M 10	96	2	4	8	7	5	4	3	6	
RSD 1000/1800	8769	2	1800	1043	1350		12 x M 10	157	4	7	16	14	10	7	6	11	
RSD 1120/ 900	8770	1	900	1174	1350		12 x M 10	81	2	3	7	6	4	3	3	5	
RSD 1120/1800	8771	2	1800	1174	1350		12 x M 10	136	3	6	14	11	8	6	5	9	
RSD 1250/ 900	8772	1	900	1311	1460		12 x M 10	86	1	2	5	4	3	2	2	3	
RSD 1250/1800	8773	2	1800	1311	1460		12 x M 10	146	2	4	11	9	7	5	4	6	

Energy-efficient roof fans.
Vertical, horizontal, diagonal discharge.



The wide range of roof fans from Helios offers the optimal solution for every application.

From 460 to 26 500 m³/h air flow volume, with motors inside or outside the air flow, horizontal, diagonal or vertical air discharge.

In metal or polymer casing, for air flow temperatures of up to +70 °C, +120 °C and in temperature class F400 (120 min.) according to DIN 12101-3.

438^{on}

**DIAGONAL.
HORIZONTAL.
ENERGY-EFFICIENT.**

DV EC and RD EC

Energy-saving EC centrifugal roof fans are available with diagonal or horizontal air discharge.

With extremely weather-resistant polymer casing and optional Eco/Pro versions, DV EC is suitable for different applications.

444^{on}

**VERTICAL OR
HORIZONTAL
DISCHARGE.**

VD and RD

The new standard range includes vertically discharging models from the VD series and horizontally discharging models from the RD series with high-performance centrifugal impellers, as well as specially adapted speed-controllable AC motors in closed design.

458^{on}

ACCESSORIES

Perfectly matched accessories for the roof fans round off the integrated overall solution.

484^{on}

This information supplements the "General technical information" and statements on the product pages.

Common features in the VD and VDR types with vertical discharge.

■ **Features**

As the exhaust air is discharged vertically, this has the following advantages:

- Less harmful impact on the environment through contamination.
- Minimised solids deposits on roofs, roof windows and skylights.
- Reduction of potentially disruptive influences (e.g. smells, damp) on the adjacent building, windows, open hatches and chimneys or other inflowing and exhaust air roof fans in the surrounding area.

Common features in the VD and VDR types with vertical discharge and horizontal RD types.

■ **Noise**

Information on this can be found on the product pages and under the "General technical product information".

■ **Incorrect direction of rotation**

The devices can only be used for exhaust air operations. Operating the device in an incorrect direction of rotation overloads the motor and trips any fitted thermal contacts or PTC thermistors. Typical concomitant features for this are the practical lack of air flow capacity, vibration and abnormal noise.

■ **Installation**

The roof fans must be installed horizontally. When the roofs are sloped, this is to be implemented using a suitable base frame design as otherwise water entry has to be expected. See the DV EC model on page 440 for details on the delivery and constructing the base frame.

■ **VDR design**

Centrifugal roof fan with vertical discharge and exterior override switch. Casing and base plate made of galvanised sheet steel. The fans are wired to the override switch by the manufacturer. The base plate of the casing is equipped with bores (hole pattern according to DIN 24155 page 3) for connecting suction-side accessories.

■ **Motor**

External rotor motors with a closed design (IP 44) located in the air flow are used. They are designed in accordance with DIN EN 60034 / VDE 0530 and



DIN EN 60335-1 / VDE 0700-1, insulation class B and protection category I. They are equipped with low-maintenance ball bearings, which have enough lubricant supply for up to 30.000 hours of operation.

■ **Impellers**

High-performance centrifugal impellers with backwards curved vanes made of polymer. Low-vibration operation thanks to dynamic balancing in accordance with DIN ISO 1940 T.1 – grade 6.3.

■ **Air flow temperatures**

The devices can be used in the range of -40 °C to at least +60 °C. The upper limit is type-specific and is shown in the table on the product page. If the fan is speed-controlled, the value is to be reduced by around 10 °C.

■ **Speed control**

Information on this can be found on the product pages and under the "General technical product information".

■ **Electrical connection**

The supply feed can come from beneath via a cable bushing in the base plate and from above (via the roof). It is to be connected without dismantling further parts on the exterior terminal box according to the attached circuit diagram.

■ **Motor protection**

Information on this can be found on the product pages and under the "General technical product information".

■ **VD design**

Robust design, largely corrosion-resistant and weather-resistant. Motor bedplate and base plate with stainless steel inlet nozzle. Casing made of aluminium resistant to sea water with built-in interference protection. In all types with explosion protection, the base plate is made of galvanised sheet steel with an aluminium inlet nozzle. Quiet operation thanks to vibration-damping motor suspension. Flat construction design.



■ **Motor**

VD: External rotor motors located in the air flow with degree of protection IP 44 or IP 54 and in insulation class F according to DIN EN 60034 / VDE 0530 and DIN EN 60335-1 / VDE 0700-1 are used for the AC types. The winding is also impregnated for moisture resistance. The low-maintenance ball bearings have enough lubricant for a service life of approximately 30.000 hours of operation. The motor and impeller are dynamically balanced as a single unit in accordance with DIN ISO 1940 T.1 – grade 6.3 for low-vibration operations.

VD T120: Flange motors with self-ventilation (T120 design) with degree of protection IP 54 or IP 55 and in insulation class F according to DIN EN 60034 / VDE 0530 and DIN EN 60335-1 / VDE 0700-1 are used for the AC types. The motor is located outside the air flow. The winding is also impregnated for moisture resistance. The low-maintenance ball bearings have enough lubricant for a service life of approximately 30.000 hours of operation. The motor and impeller are dynamically balanced as a single unit in accordance with DIN ISO 1940 T.1 – grade 6.3 for low-vibration operations.

■ **Impellers**

VD/VD T120: High-performance centrifugal impellers with backwards curved vanes made of galvanised sheet steel, polymer or aluminium. Low-vibration operation thanks to dynamic balancing in accordance with DIN ISO 1940 T.1 – grade 6.3.

■ **Protection against contact**

All devices are delivered with a protective grille on the exhaust air side according to DIN EN ISO 13857 as standard. If the system does not provide any protection against contact with rotating parts on the intake side, a guard is also to be attached here (accessory).

■ **Air flow temperatures**

VD: The devices can be used in the range of -20 °C to at least +70 °C. The upper limit is type-specific and is shown in the table on the product page. If the fan is speed-controlled, the value is to be reduced by around 10 °C. Types with explosion protection are permitted for use up to a maximum of +40 °C.

VD T120: The devices can be used in the range of -30 °C to at least +120 °C. If the fan is speed-controlled, the value is to be reduced by around 10 °C.

■ **Speed control**

Information on this can be found on the product pages and under the "General technical product information". The types with voltage control are marked by a value in the column "Current consumption when regulated".

■ **Electrical connection**

The supply feed can come from beneath via a cable bushing in the base plate and from above (via the roof). It is to be connected without dismantling further parts on the exterior terminal box or override switch according to the attached circuit diagram.

■ **Full motor protection**

Information on this can be found on the product pages and under the "General technical product information".

■ **Explosion protection**

The types with explosion protection are in line with equipment group II, category 3G for use in zone 2 in accordance with Directive 2014/34/EU. The types with explosion protection and diameters from 315 to 560 mm are in line with equipment group II, category 2G for use in zone 1 in accordance with Directive 2014/34/EU.

The EU conformity declaration enclosed with every fan attests to the design according to DIN EN 60079-0 / VDE 0170-1 and DIN EN 60079-7 / VDE 0170-6. The degree of protection is in line with Ex e 2G. The temperature class is marked on the type side.

The exterior terminal box also satisfies Ex e 2G. Further statements can be found in the sections "Project planning instructions for explosion protection" and "General technical information". Larger air gaps, which can reduce performance by up to 10 %, are required under EU Directive 2014/34/EU.



■ RD design

Robust design, largely corrosion-resistant and weather-resistant. Motor bedplate and base plate with stainless steel inlet nozzle. Casing made of aluminium resistant to sea water with built-in interference protection. In all types with explosion protection, the base plate is made of galvanised sheet steel with an aluminium inlet nozzle. Quiet operation thanks to vibration-damping motor suspension. Flat construction design.

■ Motor

External rotor motors located in the air flow with degree of protection IP 44 or IP 54 and in insulation class F according to DIN EN 60034 / VDE 0530 and DIN EN 60335-1 / VDE 0700-1 are used for the AC types. The winding is also impregnated for moisture resistance. The low-maintenance ball bearings have enough lubricant for a service life of approximately 30.000 hours of operation. The motor and impeller are dynamically balanced as a single unit in accordance with DIN ISO 1940 T.1 – grade 6.3 for low-vibration operations.

■ Impellers

High-performance centrifugal impellers with backwards curved vanes made of galvanised sheet steel, polymer or aluminium. Low-vibration operation thanks to dynamic balancing in accordance with DIN ISO 1940 T.1 – grade 6.3.

■ Protection against contact

All devices are delivered with a protective grille on the exhaust air side according to DIN EN ISO 13857 as standard. If the system does not provide any protection against contact with rotating parts on the intake side, a protective grille is also to be attached here (accessory).

■ Air flow temperatures

The devices can be used in the range of -20 °C to at least $+70\text{ °C}$. Types with explosion protection are permitted for use up to a maximum of $+40\text{ °C}$. The upper limit is type-specific and is shown in the table on the product page. If the fan is speed-controlled, the value is to be reduced by around 10 °C .

■ Speed control

Information on this can be found on the product pages and under the "General technical information".

■ Electrical connection

The supply feed can come from beneath via a cable bushing in the base plate and from above (via the roof). It is to be connected without dismantling further parts on the exterior terminal box or override switch according to the attached circuit diagram.

■ Full motor protection

Information on this can be found on the product pages and under the "General technical product information".

■ Explosion protection

The types with explosion protection are in line with equipment group II, category 3G for use in zone 2 in accordance with Directive 2014/34/EU. The types with explosion protection and diameters from 315 to 560 mm are in line with equipment group II, category 2G for use in zone 1 in accordance with Directive 2014/34/EU.

The EU conformity declaration enclosed with every fan attests to the design according to DIN EN 60079-0 / VDE 0170-1 and DIN EN 60079-7 / VDE 0170-6. The degree of protection is in line with Ex e 2G. The temperature class is marked on the type page.

The exterior terminal box also satisfies Ex e 2G. Further statements can be found in the sections "Project planning instructions for explosion protection" and "General technical information". Larger air gaps, which can reduce performance by up to 10%, are required under EU Directive 2014/34/EU.

Information	Page
Information for planning, acoustics, explosion prot.	10 on General techn. information,
speed control	15 on

■ **RD EC range**

EC centrifugal fans with horizontal discharge for exhaust air operation.

■ **Design**

Robust design, largely corrosion-resistant and weather-resistant. Base plate made of galvanised sheet steel. Rain hood and protective grille made of galvanised sheet steel, for nominal diameter 225 – 400 mm made of aluminium. Quiet operation thanks to vibration-dampening motor suspension. Flat construction design. Rain hood with cover extending far above and below the fan offers effective protection against rainfall.

■ **Motor**

External rotor motors with degree of protection IP 44 and in insulation class B according to DIN EN 60034 / VDE 0530 and DIN EN 60335-1 / VDE 0700-1 are used for the AC types. The winding is also impregnated for moisture resistance. The low-maintenance ball bearings have enough lubricant for a service life of approximately 30.000 hours of operation. The motor and impeller are dynamically balanced as a single unit in accordance with DIN ISO 1940 T.1 – grade 6.3 for low-vibration operations.

■ **Impellers**

Centrifugal impellers with optimised efficiency and high power density and backwards curved vanes made of stainless sheet steel. Pressed on to the motor and dynamically balanced as a single unit.

■ **Protection against contact**

All devices are delivered with a protective grille on the exhaust air side according to DIN EN ISO 13857 as standard. If the system does not provide any protection against contact with rotating parts on the intake side, a guard is also to be attached here (accessory).

■ **Air flow temperatures**

The range of application for EC types is up to +40 °C. At higher temperatures, the built-in thermal fuses will be activated.

■ **Speed control**

The speed can be controlled in all EC types using a potentiometer, universal control system or electronic differential pressure/temperature controller (in conjunction with NG24 power supply unit, accessory). Sample power levels are shown in the characteristic curve. Suitable

RD EC



control units are listed in the type table. Further information on this is available in the "General technical information".

■ **Electrical connection**

The supply feed can come from beneath via a cable bushing in the base plate and from above (via the roof). The connection is to be made at the terminal box (degree of protection IP 55) located under the rain hood. An additional control line is required for EC types.

■ **Full motor protection**

The EC motors are protected by the built-in electronic temperature monitoring system.

■ **Noise**

Information on this can be found on the product pages and under the "General technical product information".

■ **DV EC range**

Centrifugal fans with a diagonal discharge for exhaust air operation. With EC motor technology for energy-saving use and minimum operating costs.

■ **Design**

Extremely weather-resistant EC roof fan with polymer design in a comprehensive area of applications. Aerodynamically designed polymer casing made of grey polypropylene with diagonal discharge. Air flow temperatures from –30 to +60 °C.

■ **Motor**

Energy-efficient EC external rotor motor with degree of protection IP 54. Optimised efficiency also with speed control for low operating costs. Seamless speed control. Low-maintenance and interference-free, ball bearing mounted.

■ **Impellers**

Diagonal aluminium impeller. The motor impeller unit is dynamically balanced for quiet operation.

■ **Protection against contact**

All devices are delivered with a protective grille on the exhaust air side according to DIN EN ISO 13857 as standard. If the

DV EC



system does not provide any protection against contact with rotating parts on the intake side, a protective grille is also to be attached here (accessory).

■ **Air flow temperatures**

Air flow temperatures from –30 to +60 °C.

■ **Speed control**

■ **DV EC Pro**

□ Ideal as a central exhaust air fan for multi-storey apartment buildings according to DIN 18017-3.

□ In conjunction with further components (accessories), a complete central ventilation system can be established according to DIN 18017-3 with demand-based ventilation.

□ Built-in pressure regulation for air flow volume stabilising in adjacent rooms by automatic speed adjustment with an almost constant, high degree of efficiency.

□ Integrated pressure sensor 0–300 Pa.

□ Short amortisation period thanks to high energy savings.

□ Operating data settings at the four potentiometers integrated in the control to set the desired operating point on-site.

□ Built-in bus interface (RS 485) as standard for connecting to a PC/laptop in conjunction with the interface (accessories).

■ **DV EC Eco**

□ The speed can be controlled in all EC types using a potentiometer, universal control system or electronic differential pressure / temperature controller (in conjunction with NG24 power supply unit, accessory). Sample power levels are shown in the characteristic curve. Suitable control units are listed in the type table. Further information on this is available in the "General technical information".

■ **Electrical connection**

Polymer operating switch (degree of protection IP 65) as standard, fitted on the outside of the casing. Supply voltage 1 ph., 230 V, 50 Hz.

■ **Full motor protection**

Integrated electronic temperature monitoring for EC motor and electronics.

■ **Noise**

Information on this can be found on the product pages and under the "General technical product information".

■ **Base frame construction, installation, delivery**

Delivered ready for installation in individual shipping boxes or crates. The fans are quick and easy to install, they are equally suited to installation on flat, gable, monopitch, saw-tooth, angular, trapezoidal or arched roofs. In principle, the base frames are always to be designed such that the fan base plate lies flat and level.

We recommend the use of flat, slanted or wavy roof base frames available in our accessories range. This keeps the costs for planning, design and installation to a minimum. The base frames can also be made on-site, for example from concrete, wood, bricks or the like. However, a level and flat surface is just as vital as proper sealing at the roof edge.

After it is placed, the base plate is connected to the base frame with four screws. Helios flat roof base frames and base frame attenuators with nominal diameters 180 – 450 mm have a folding mechanism that is advantageous when it comes to cleaning and inspections.

For on-site base frames, spacer discs are to be used to balance out any unevenness. A gap arising between the base plate and base frame is to be sealed off with elastic or similar material. After the screws are tightened equally, check the impeller's freedom of movement.

By combining the parameters of static pressure increase Δp_{fa} , air flow volume V , R.P.M. min^{-1} , sound level at 4 m and impeller-diameter DN mm, the following table facilitates the selection of roof fans \varnothing 180 to 710.

Diameter	R.P.M.	Sound pressure intake	Air flow volume V m^3/h in relation to static pressure = N / m^2 = freely available pressure												
mm	min^{-1}	L_{PA} dB(A)	(Δp_{fa}) in Pa												
		at 4m													
Series VD/VDR/RD			0	50	100	150	200	250	300	350	400	500	600	700	800
180	2300	46	2300	46	550	500	430	380	300	240	150				
200	2300	53	1050	960	920	860	760	700	560	460	300				
200	1400	37	550	430	280										
225	2700	56	1300	1240	1180	1120	1060	1000	920	840	760	520			
225	1400	42	650	550	400										
250	1400	43	920	800	640	440									
315	1400	51	2900	2700	2500	2350	2100	1800	1500	700					
355	1400	54	4500	4300	4000	3800	3500	3250	3000	2500	1500				
400	1400	57	6000	5800	5400	5100	4800	4500	4200	3800	3400	2000			
400	900	49	4000	3600	3200	2700	2000	500							
450	1400	62	8600	8400	8000	7800	7500	7300	6900	6700	6400	5500	4200	2200	
			0	100	200	300	400	500	600	700	800	900	1000	1100	1200
500	1400	65	12000	11300	10400	9600	9000	8200	7200	5600	3500				
500	900	56	7200	6300	5050	3300									
560	1400	69	14200	13500	12800	12000	11200	10400	9600	8500	7400	6000	4700	3200	
560	900	60	9300	8400	7500	6400	4800								
630	900	66	15000	13800	12600	11000	9100	5600							
710	900	66	26500	24800	23000	21200	18800	16500	14700	11200	7500				

By combining the parameters of static pressure increase Δp_{fa} , air flow volume V , R.P.M. min^{-1} , sound level at 4 m and impeller-diameter DN mm, the following table facilitates the selection of roof fans \varnothing 200 to 450.

Diameter mm	R.P.M. min^{-1}	Sound pressure intake L_{PA} dB(A) at 4 m	Air flow volume V m^3/h in relation to static pressure = N / m^2 = freely available pressure (Δp_{fa}) in Pa																
			0	50	100	150	200	250	300	350	400	450	500	550	600	650	700	750	800
Series DV EC – diagonal discharge																			
200	1810	50	2010	1830	1660	1480	1270	1030	720	350									
250	1640	55	3700	3480	3210	2930	2700	2420	2090	1690	1240	240							
400 A	1020	48	4070	3660	3220	2720	2200	1610	980										
400 B	1425	60	5650	5470	5100	4760	4480	4150	3800	3440	3000	1870							
Series RD EC – horizontal discharge																			
225	1850	51	2200	2060	1910	1750	1580	1390	1060										
315	1260	50	4320	3970	3730	3440	3000	2290	1000										
400	1470	57	6670	6340	6000	5630	5320	5000	4650	4310	3920	3350	2590	700					
450	1180	53	8360	8000	7480	6970	6440	5970	5480	5000	4390	1100							

Centrifugal roof fan RD

Horizontal discharge

Affordable price-performance relationship. Horizontally discharging roof fan with efficiency-optimised aluminium casing and newly developed high-performance centrifugal impeller.

EC roof fans DV

Diagonal discharge

With energy-saving EC motor technology for lowest operating costs. Extremely weather-resistant, in polymer design. Optional in Pro version with integrated pressure control for maintaining constant air flow volume (without illustration).

Centrifugal roof fans VD and VDR

Vertical discharge

Affordable price-performance relationship. Vertically discharging roof fan with efficiency-optimised aluminium casing or casing made from galvanised sheet steel and newly developed high-performance centrifugal impeller.

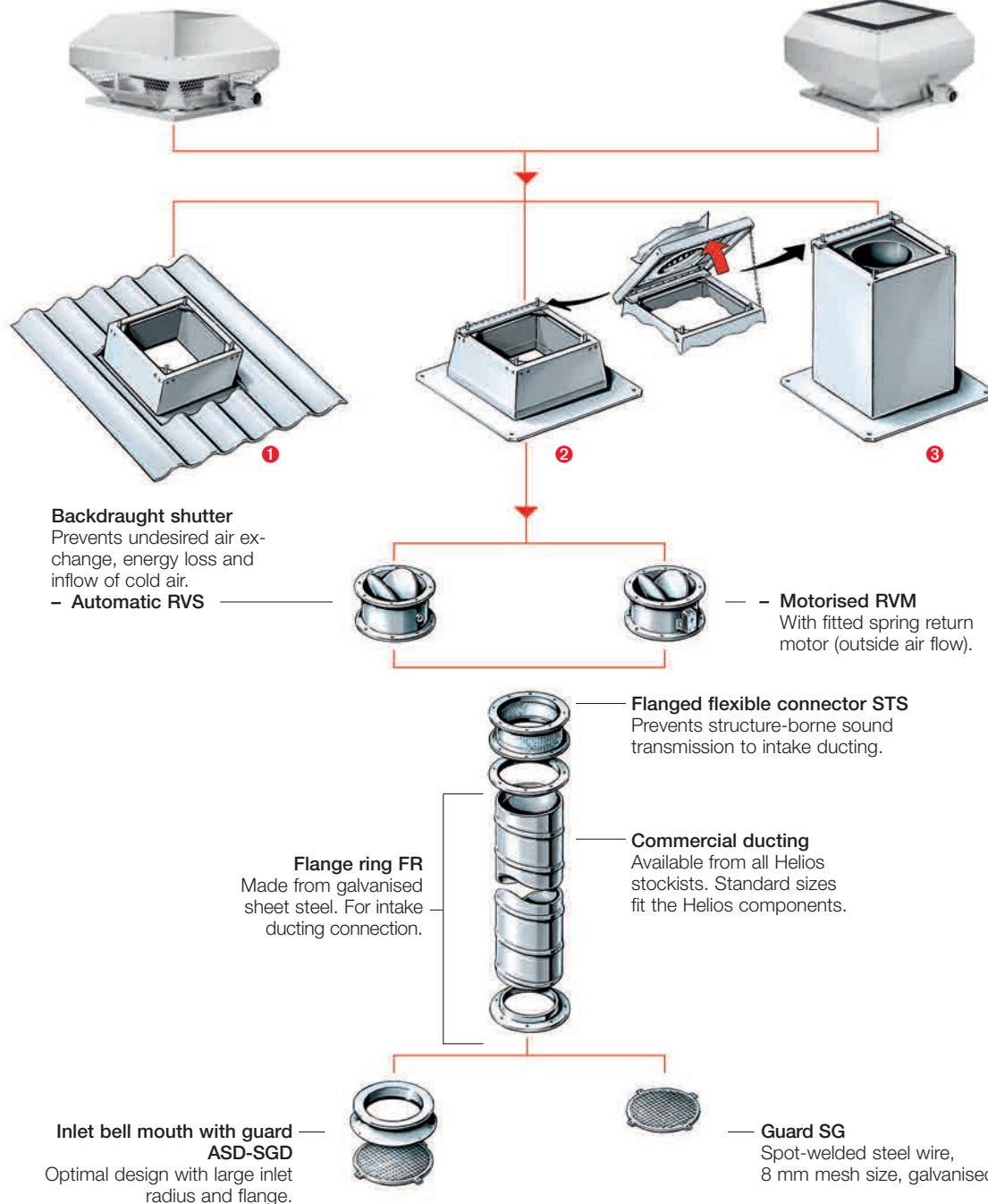

Backdraught shutter

Prevents undesired air exchange, energy loss and inflow of cold air.

– Automatic RVS

– Motorised RVM

With fitted spring return motor (outside air flow).

Flanged flexible connector STS

Prevents structure-borne sound transmission to intake ducting.

Commercial ducting

Available from all Helios stockists. Standard sizes fit the Helios components.

Flange ring FR

Made from galvanised sheet steel. For intake ducting connection.

Inlet bell mouth with guard ASD-SGD

Optimal design with large inlet radius and flange.

Guard SG

Spot-welded steel wire, 8 mm mesh size, galvanised.

1 Soaker sheet WDS

For installation of roof fans and roof cowls on corrugated roofs. Weather resistant and corrosion-free made of glass fibre reinforced polyester.

Sloping roof base SDS (S. 486)

For installation of roof fans/roof cowls on pitched or sloping roofs. Inner surface lined with sound and thermal insulation.

2 Flat roof base FDS

For low priced and efficient mounting of roof fans and roof cowls on flat roofs. In corrosion-resistant glass fibre reinforced polyester or galvanised sheet steel. Nominal size 180 to 450 with hinged mechanism for simple inspection and cleaning.

3 Base attenuator SSD

For intake-side sound insulation. All metal parts made of galvanised steel. Incl. fixing screws, profile rubber and sealing between base and base plate. Nominal size 180 to 450 mm with hinged mechanism and foamed material core with free cross-section. Allows access to ducting or ventilation system.

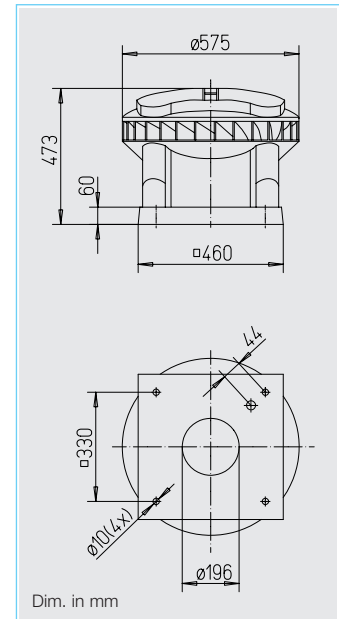

Extremely weather-proof diagonally discharging EC-roof fan from polymer for an extensive area of application.

Similarities DV EC Pro and DV EC Eco

Casing
Aerodynamically designed casing from high-quality polypropylene in grey with diagonal air discharge direction. Air flow temperatures from -30 to +60 °C.

Impeller
Diagonal impeller made from aluminium, the motor-impeller unit is dynamically balanced for low-noise operation.

Motor
Optimised efficiency also with speed control for low operating costs. Stepless speed control. Ball bearing mounted, maintenance-free and interference-free.

Motor protection
Integrated electronic temperature monitoring for EC-motor and electronics.

Electrical connection
Standard external terminal box (protection to IP 65) on the casing. Connection voltage single-phase, 230 V, 50 Hz.

Installation
Horizontal alignment on the roof. With pitched roofs, a suitable upstand must be constructed, to prevent water entry. Extensive accessories facilitate the assembly of the fan to the ducting system in the building.

Sound levels
Total sound power levels and the spectrum figures in dB(A) are given for:
- Sound power intake
- Sound power exhaust
In the table below as well as underneath the performance curve you can find additionally the sound pressure level at 4 m (free field conditions).

Specification DV EC Pro

- Speed control**
 - Ideal as a central exhaust air fan for multi-storey building DIN 18017-3.
 - In connection with further components (accessories) a complete central ventilation system can be developed according to DIN 18017-3 with ventilation according to need.
 - Integrated pressure control for air flow volume stabilisation in the connected rooms by automatic speed adaptation with nearly consistently good efficiency.
 - Integrated pressure sensor 0-300 Pa.
 - Short payback period due to high energy conservation.
 - Four potentiometers integrated in the control permit an adjustment to the operating data. The desired operating point can be set directly on site.
 - Integrate serial Bus port (RS 485) for connection of a PC / laptop in combination with the interface (accessories).

Specification DV EC Eco

- Speed control**
 - Stepless speed control with a speed potentiometer PU/PA 10 (accessories, see table below).
 - In connection with the universal control system EUR EC or electronic pressure/temperature controllers EDR/ETR (accessories, see table below), the fan can be used for steplessly controlling differential pressure, differential temperature or flow velocity. The performance stages are shown in the characteristic curves.

Type	Ref. no.	Maximum R.P.M. approx.	Air flow volume (FID)	Sound pressure case breakout	Motor power at maximum speed		Wiring diagram	max. air flow temperature	Weight net approx.	Universal control system		Speed-potentiometer flush surface			
					kW	A				Type	Ref. no.	Type	Ref. no.	Type	Ref. no.
Type DV EC Pro, single phase motor, 230 V, 50/60 Hz, EC motor, IP 54															
DV EC 200 Pro	8385	1810	2010	52	0.18	1.38	863.1	60	17.0	—	—	—	—	—	—
Type DV EC Eco, single phase motor, 230 V, 50/60 Hz, EC motor, IP 54															
DV EC 200 Eco	8320	1810	2010	52	0.18	1.38	991	60	17.0	EUR EC ¹⁾²⁾	1347	PU 10 ³⁾	1734	PA 10 ³⁾	1735

1) several EC fans can normally be connected

2) alternative electronic pressure/temperature controller (EDR/ETR, No. 1437/1438) in connection with the power supply NG24, No. 1439, see accessories

DV EC 200

Frequency		Hz	Total	125	250	500	1k	2k	4k	8k
L _{WA}	Intake		70	54	64	64	65	61	55	46
L _{WA}	Exhaust		72	53	57	66	69	66	57	46

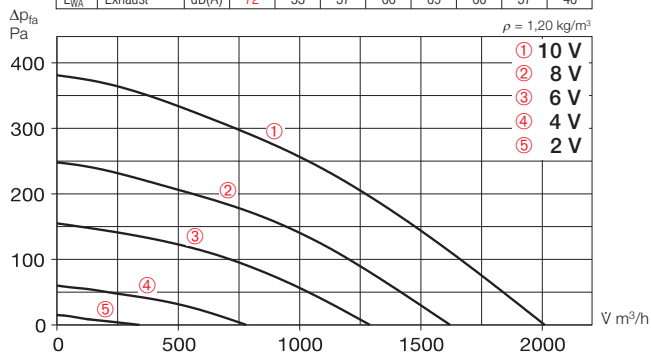

Voltage V	n min ⁻¹	V m ³ /h	P W	I A	Lp dB(A)	SFP kW/m ² /s
10	1810	2010	180	1,38	52	—
8	1480	1620	108	0,90	47	—
6	1200	1290	60	0,54	41	—
4	720	780	21	0,20	31	—

Accessory details Page

Roof mounting accessories	485
Ventilation grilles	487 on
Extract elements	500 on
Intake elements	512 on
Fire protection elements	516 on
Universal control system, electronic controller, speed-potentiometer	539 on

Accessories for all types

Hinged base attenuator

Type SSD 200 Ref. no. 5290

With folding mechanism for easy inspection and cleaning.

Flange connecting plate

Type FAP 200 Ref. no. 8382

Made from galvanised sheet steel. Makes the connection of the duct system plus accessories to the roof fans DV EC possible, if no base attenuator SSD is used.

Flat roof base

Type FDS 200 Ref. no. 1378

With folding mechanism for easy inspection and cleaning.

Counterflange

Type DFR 200 Ref. no. 1201

Made from galvanised sheet steel, for intake duct connections.

Flanged flexible connector

Type DSTS 200 Ref. no. 1218

To reduce vibration transmission in intake air ducting. Flanges made of galvanised steel.

Backdraught shutter

Type DRVS 200 Ref. no. 2591

Automatic, made of galvanised sheet steel. To prevent cold air backdraught when the fan is not in use. For vertical air flow bottom-up position.

Accessories for DV EC Pro

Interface

Type ZLS-IF Ref. no. 8391

Interface for the start-up and/or control of the fan in connection with a PC/Laptop. Power supply unit, adaptor cable and software included.

Electronic timer module

Type ZLS-ZU 31 Ref. no. 8388

Allows parallel operation of max. 31 DV EC roof fans. The rocker main switch activates the timer module.

The day and night regulation is carried out by adjustment in the display. Main switch 230 V, 50 Hz included.

Accessories for DV EC Eco

Universal control system

Type EUR EC Ref. no. 1347

For stepless control or adjustment of single- and 3-phase EC-fans with an input control signal of 0–10 V DC.

Speed potentiometer

Type PU/PA 10 see type table

For direct control or nominal value preset of EC-fans with potentiometer input.

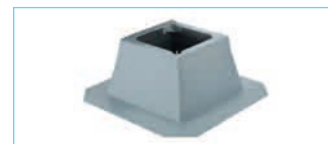

Timer for controlling up to 31 fans	
Type	Ref. no.
ZLS-ZU 31	8388
—	—

3) without LED power supply

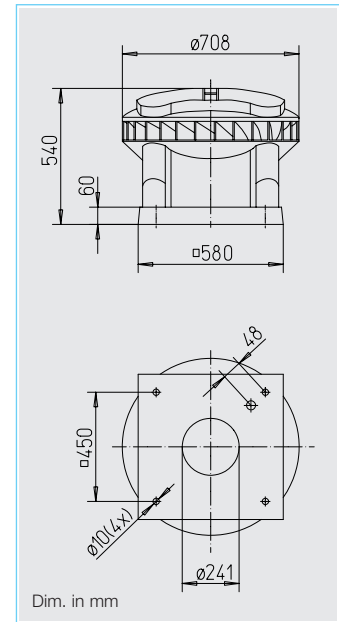

■ **Extremely weather-proof diagonally discharging EC-roof fan from polymer for an extensive area of application.**

■ **Similarities DV EC Pro and DV EC Eco**

□ **Casing**
Aerodynamically designed casing from high-quality polypropylene in grey with diagonal air discharge direction. Air flow temperatures from -30 to +60 °C.

□ **Impeller**
Diagonal impeller made from aluminium, the motor-impeller unit is dynamically balanced for low-noise operation.

□ **Motor**
Optimised efficiency also with speed control for low operating costs. Stepless speed control. Ball bearing mounted, maintenance-free and interference-free.

□ **Motor protection**
Integrated electronic temperature monitoring for EC-motor and electronics.

□ **Electrical connection**
Standard external terminal box (protection to IP 65) on the casing. Connection voltage single-phase, 230 V, 50 Hz.

□ **Installation**
Horizontal alignment on the roof. With pitched roofs, a suitable upstand must be constructed, to prevent water entry. Extensive accessories facilitate the assembly of the fan to the ducting system in the building.

■ **Sound levels**
Total sound power levels and the spectrum figures in dB(A) are given for:
- Sound power intake
- Sound power exhaust
In the table below as well as underneath the performance curve you can find additionally the sound pressure level at 4 m (free field conditions).

■ **Specification DV EC Pro**

- **Speed control**
 - Ideal as a central exhaust air fan for multi-storey building DIN 18017-3.
 - In connection with further components (accessories) a complete central ventilation system can be developed according to DIN 18017-3 with ventilation according to need.
 - Integrated pressure control for air flow volume stabilisation in the connected rooms by automatic speed adaptation with nearly consistently good efficiency.
 - Integrated pressure sensor 0-300 Pa.
 - Short payback period due to high energy conservation.
 - Four potentiometers integrated in the control permit an adjustment to the operating data. The desired operating point can be set directly on site.
 - Integrate serial Bus port (RS 485) for connection of a PC / laptop in combination with the interface (accessories).

■ **Specification DV EC Eco**

- **Speed control**
 - Stepless speed control with a speed potentiometer PU/PA 10 (accessories, see table below).
 - In connection with the universal control system EUR EC or electronic pressure/temperature controllers EDR/ETR (accessories, see table below), the fan can be used for steplessly controlling differential pressure, differential temperature or flow velocity. The performance stages are shown in the characteristic curves.

Type	Ref. no.	Maximum R.P.M. approx.	Air flow volume (FID)	Sound pressure	Motor power at maximum speed		Wiring diagram	max. air flow temperature	Weight net approx.	Universal control system		Speed-potentiometer			
					kW	A				Type	Ref. no.	Type	Ref. no.	Type	Ref. no.
Type DV EC Pro, single phase motor, 230 V, 50/60 Hz, EC motor, IP 54															
DV EC 250 Pro	8386	1640	3700	60	0.41	1.78	863.1	60	23.0	—	—	—	—	—	—
Type DV EC Eco, single phase motor, 230 V, 50/60 Hz, EC motor, IP 54															
DV EC 250 Eco	8322	1640	3700	60	0.41	1.78	991	60	23.0	EUR EC ¹⁾²⁾	1347	PU 10 ³⁾	1734	PA 10 ³⁾	1735

1) several EC fans can normally be connected 2) alternative electronic pressure/temperature controller (EDR/ETR, No. 1437/1438) in connection with the power supply NG24, No. 1439, see accessories

DV EC 250

Frequency		Hz	Total	125	250	500	1k	2k	4k	8k
L _{WA}	Intake	dB(A)	75	60	64	70	69	67	61	52
L _{WA}	Exhaust	dB(A)	80	63	65	75	76	72	63	52

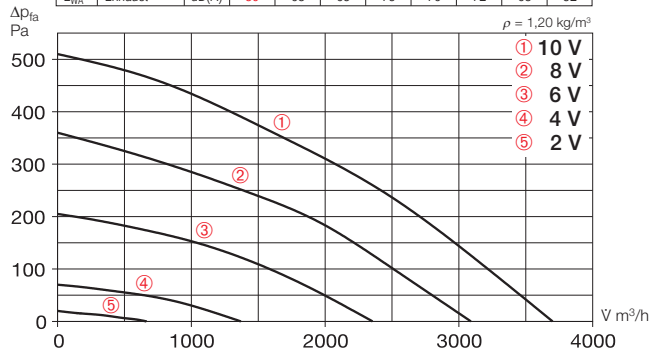

Voltage V	n min ⁻¹	V m ³ /h	P W	I A	Lp dB(A)	SFP kW/m ² /s
10	1640	3700	412	1,78	60	—
8	1380	3100	264	1,14	55	—
6	1100	2350	138	0,60	49	—
4	650	1370	40	0,20	36	—

Accessory details Page

Roof mounting accessories	485
Ventilation grilles	487 on
Extract elements	500 on
Intake elements	512 on
Fire protection elements	516 on
Universal control system, electronic controller, speed-potentiometer	539 on

Accessories for all types

Hinged base attenuator

Type SSD 250 Ref. no. 5292

With folding mechanism for easy inspection and cleaning.

Flange connecting plate

Type FAP 250 Ref. no. 8383

Made from galvanised sheet steel. Makes the connection of the duct system plus accessories to the roof fans DV EC possible, if no base attenuator SSD is used.

Flat roof base

Type FDS 250 Ref. no. 1379

With folding mechanism for easy inspection and cleaning.

Counterflange

Type FR 250 Ref. no. 1203

Made from galvanised sheet steel, for intake duct connections.

Flanged flexible connector

Type STS 250 Ref. no. 1220

To reduce vibration transmission in intake air ducting. Flanges made of galvanised steel.

Backdraught shutter

Type RVS 250 Ref. no. 2592

Automatic, made of galvanised sheet steel. To prevent cold air backdraught when the fan is not in use. For vertical air flow bottom-up position.

Accessories for DV EC Pro

Interface

Type ZLS-IF Ref. no. 8391

Interface for the start-up and/or control of the fan in connection with a PC/Laptop. Power supply unit, adaptor cable and software included.

Electronic timer module

Type ZLS-ZU 31 Ref. no. 8388

Allows parallel operation of max. 31 DV EC roof fans. The rocker main switch activates the timer module.

The day and night regulation is carried out by adjustment in the display. Main switch 230 V, 50 Hz included.

Accessories for DV EC Eco

Universal control system

Type EUR EC Ref. no. 1347

For stepless control or adjustment of single- and 3-phase EC-fans with an input control signal of 0–10 V DC.

Speed potentiometer

Type PU/PA 10 see type table

For direct control or nominal value preset of EC-fans with potentiometer input.

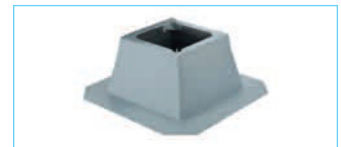

Type	Ref. no.
ZLS-ZU 31	8388
—	—

3) without LED power supply

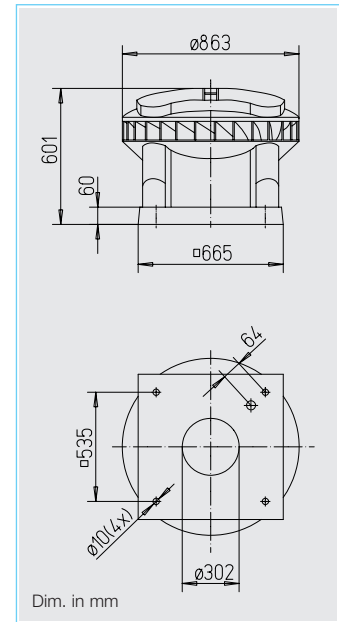

45% Saving*
* with speed control

■ **Extremely weather-proof diagonally discharging EC-roof fan from polymer for an extensive area of application.**

■ **Similarities DV EC Pro and DV EC Eco**

□ **Casing**
Aerodynamically designed casing from high-quality polypropylene in grey with diagonal air discharge direction. Air flow temperatures from -30 to +60 °C.

□ **Impeller**
Diagonal impeller made from aluminium, the motor-impeller unit is dynamically balanced for low-noise operation.

□ **Motor**
Optimised efficiency also with speed control for low operating costs. Stepless speed control. Ball bearing mounted, maintenance-free and interference-free.

□ **Motor protection**
Integrated electronic temperature monitoring for EC-motor and electronics.

□ **Electrical connection**
Standard external terminal box (protection to IP 65) on the casing. Connection voltage single-phase, 230 V, 50 Hz.

□ **Installation**
Horizontal alignment on the roof. With pitched roofs, a suitable upstand must be constructed, to prevent water entry. Extensive accessories facilitate the assembly of the fan to the ducting system in the building.

■ **Sound levels**
Total sound power levels and the spectrum figures in dB(A) are given for:
- Sound power intake
- Sound power exhaust
In the table below as well as underneath the performance curve you can find additionally the sound pressure level at 4 m (free field conditions).

■ **Specification DV EC Pro**

- **Speed control**
 - Ideal as a central exhaust air fan for multi-storey building DIN 18017-3.
 - In connection with further components (accessories) a complete central ventilation system can be developed according to DIN 18017-3 with ventilation according to need.
 - Integrated pressure control for air flow volume stabilisation in the connected rooms by automatic speed adaptation with nearly consistently good efficiency.
 - Integrated pressure sensor 0-300 Pa.
 - Short payback period due to high energy conservation.
 - Four potentiometers integrated in the control permit an adjustment to the operating data. The desired operating point can be set directly on site.
 - Integrate serial Bus port (RS 485) for connection of a PC / laptop in combination with the interface (accessories).

■ **Specification DV EC Eco**

- **Speed control**
 - Stepless speed control with a speed potentiometer PU/PA 10 (accessories, see table below).
 - In connection with the universal control system EUR EC or electronic pressure/temperature controllers EDR/ETR (accessories, see table below), the fan can be used for steplessly controlling differential pressure, differential temperature or flow velocity. The performance stages are shown in the characteristic curves.

Type	Ref. no.	Maximum R.P.M. approx.	Air flow volume (FID)	Sound pressure	Motor power at maximum speed		Wiring diagram	max. air flow temperature	Weight net approx.	Universal control system		Speed-potentiometer flush			
					kW	A				Type	Ref. no.	Type	Ref. no.	Type	Ref. no.
Type DV EC Pro, single phase motor, 230 V, 50/60 Hz, EC motor, IP 54															
DV EC 400 A Pro	8387	1020	4070	51	0.30	1.33	863.1	60	33.0	—	—	—	—	—	—
DV EC 400 B Pro	8389	1425	5650	65	0.75	3.32	863.1	60	35.0	—	—	—	—	—	—
Type DV EC Eco, single phase motor, 230 V, 50/60 Hz, EC motor, IP 54															
DV EC 400 A Eco	8324	1020	4070	51	0.30	1.33	991	60	33.0	EUR EC ^{1) 2)}	1347	PU 10 ³⁾	1734	PA 10 ³⁾	1735
DV EC 400 B Eco	8326	1425	5650	65	0.75	3.32	991	60	35.0	EUR EC ^{1) 2)}	1347	PU 10 ³⁾	1734	PA 10 ³⁾	1735

1) several EC fans can normally be connected 2) alternative electronic pressure/temperature controller (EDR/ETR, No. 1437/1438) in connection with the power supply NG24, No. 1439, see accessories

DV EC 400 A

Frequency		Hz	Total	125	250	500	1k	2k	4k	8k
L _{WA}	Intake		68	55	62	63	63	58	51	44
L _{WA}	Exhaust		72	56	61	68	67	60	52	43

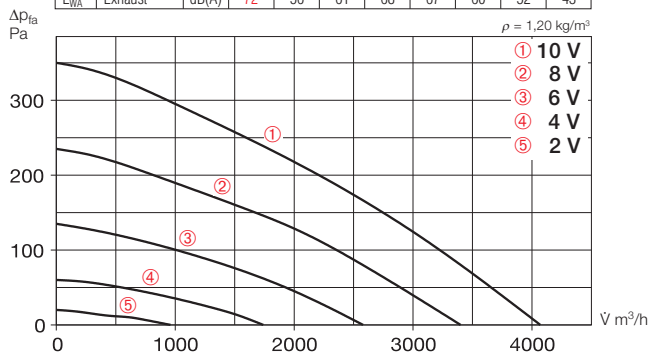

Voltage V	n min ⁻¹	\dot{V} m ³ /h	P W	I A	Lp dB(A)	SFP kW/m ² /s
10	1020	4070	303	1,33	51	—
8	850	3400	176	0,77	46	—
6	650	2580	85	0,40	40	—
4	450	1740	33	0,20	31	—

DV EC 400 B

Frequency		Hz	Total	125	250	500	1k	2k	4k	8k
L _{WA}	Intake		80	64	69	75	74	74	65	58
L _{WA}	Exhaust		85	66	72	82	81	76	66	56

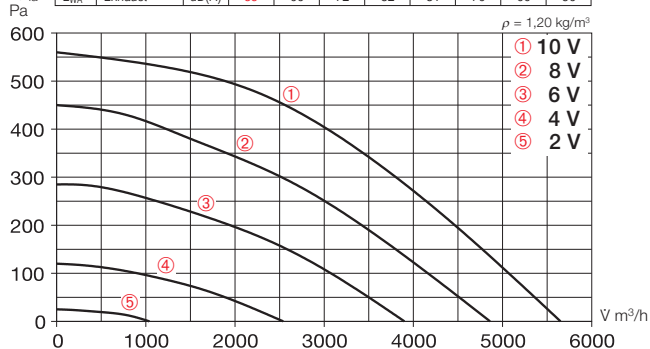

Voltage V	n min ⁻¹	\dot{V} m ³ /h	P W	I A	Lp dB(A)	SFP kW/m ² /s
10	1425	5650	755	3,32	65	—
8	1225	4860	485	2,10	60	—
6	1000	3900	265	1,15	54	—
4	650	2540	90	0,40	43	—

Accessory details Page

Roof mounting accessories	485
Ventilation grilles	487 on
Extract elements	500 on
Intake elements	512 on
Fire protection elements	516 on
Universal control system, electronic controller, speed-potentiometer	539 on

Accessories for all types

Hinged base attenuator

Type SSD 400 Ref. no. 5291

With folding mechanism for easy inspection and cleaning.

Flange connecting plate

Type FAP 400 Ref. no. 8384

Made from galvanised sheet steel. Makes the connection of the duct system plus accessories to the roof fans DV EC possible, if no base attenuator SSD is used.

Flat roof base

Type FDS 400 Ref. no. 1380

With folding mechanism for easy inspection and cleaning.

Counterflange

Type FR 400 Ref. no. 1206

Made from galvanised sheet steel, for intake duct connections.

Flanged flexible connector

Type STS 400 Ref. no. 1223

To reduce vibration transmission in intake air ducting. Flanges made of galvanised steel.

Backdraught shutter

Type RVS 400 Ref. no. 2596

Automatic, made of galvanised sheet steel. To prevent cold air backdraught when the fan is not in use. For vertical air flow bottom-up position.

Accessories for DV EC Pro

Interface

Type ZLS-IF Ref. no. 8391

Interface for the start-up and/or control of the fan in connection with a PC/Laptop. Power supply unit, adaptor cable and software included.

Electronic timer module

Type ZLS-ZU 31 Ref. no. 8388

Allows parallel operation of max. 31 DV EC roof fans. The rocker main switch activates the timer module.

The day and night regulation is carried out by adjustment in the display. Main switch 230 V, 50 Hz included.

Accessories for DV EC Eco

Universal control system

Type EUR EC Ref. no. 1347

For stepless control or adjustment of single- and 3-phase EC-fans with an input control signal of 0–10 V DC.

Speed potentiometer

Type PU/PA 10 see type table

For direct control or nominal value preset of EC-fans with potentiometer input.

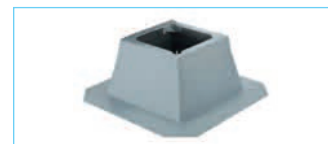

Timer for controlling up to 31 fans	
Type	Ref. no.
ZLS-ZU 31	8388
ZLS-ZU 31	8388
—	—
—	—

³⁾ without LED power supply

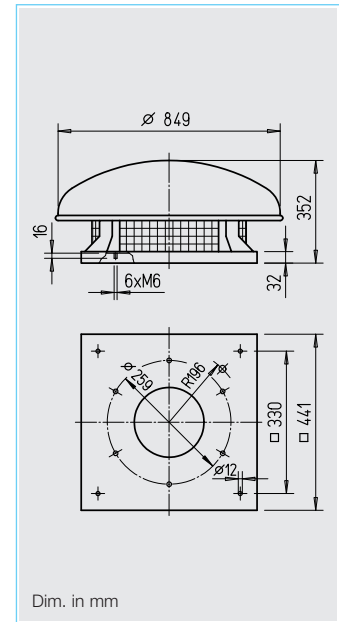
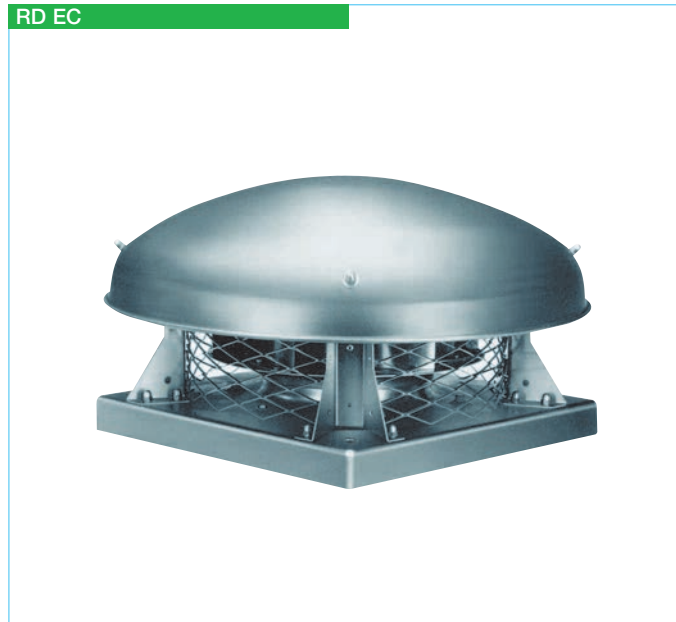

■ Specification

Centrifugal roof fan with horizontal discharge. Flat design with large overlaying rain cowl.

□ Casing

Base plate (with inlet cone) and other parts made of galvanised steel. Rain cowl and protection grille made of aluminium. Base plate with threaded bolt for connection of intake air accessories.

□ Impeller

High performance backward curved centrifugal impeller made of galvanised sheet steel, dynamically balanced with the motor unit.

□ Motor

Energy saving, speed controllable EC-external rotor motor with highest efficiency, protection to IP 44. With ball bearings, maintenance-free and interference-free.

□ Motor protection

Integrated electronic temperature monitoring for EC-motor and electronics.

□ Electrical connection

Terminal box (protection to IP 55) located beneath rain cowl as standard.

□ Guard

On the outlet as standard, compliant with DIN EN ISO 13857.

□ Speed control

Stepless speed control with potentiometer or stepless speed control with universal control system (see table). Duties at different speeds are specified in the performance curve.

□ Delivery

Fully assembled, ready to connect unit.

■ Sound levels

Total sound power levels and the spectrum figures in dB(A) are given for:

- Sound power intake
 - Sound power exhaust
- In the table below as well as underneath the performance curve you can find additionally the sound pressure level at 4 m (free field conditions).

Type	Ref. no.	Connection Ø	R.P.M.	Air flow volume (FID)	Sound press. case breakout	Motor power	Current	Wiring diagram	max. air flow temperature	Weight net approx.	Universal control system		Speed-potentiometer flush		Speed-potentiometer surface	
											Type	Ref. no.	Type	Ref. no.	Type	Ref. no.
Single phase motor, 230 V, 50/60 Hz, EC motor, IP 44																
RDW EC 225	1630	225	1850	2200	51	0.22	0.96	994	40	30.0	EUR EC¹⁾²⁾	1347	PU 10³⁾	1734	PA 10³⁾	1735

1) several EC fans can normally be connected 2) alternative electronic pressure/temperature controller (EDR/ETR, No. 1437/1438) in connection with the power supply NG24, No. 1439, see accessories 3) without LED power supply

RDW EC 225

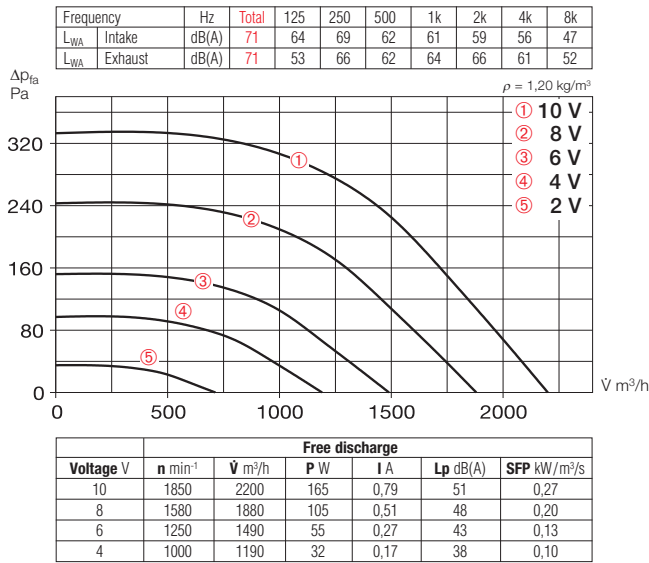

Accessory details Page

Roof mounting accessories	485
Ventilation grilles	487 on
Extract elements	500 on
Intake elements	512 on
Fire protection elements	516 on
Universal control system, electronic controller, speed-potentiometer	539 on

Accessories

Hinged base attenuator

Type SSD 225 Ref. no. 5290

With folding mechanism for easy revision and cleaning. Average attenuation is 15 dB. For intake attenuation. All metal parts made of galvanised sheet steel.



Sloping roof base

Type SDS upon request

For profile and tiled roofs. Made from galvanised sheet steel, with sound and heat-insulated cladding on the inside. Roof pitch up to 45°.

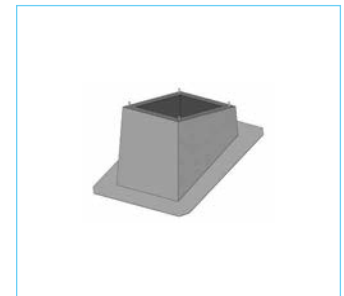

Flat roof base

Type FDS 225 Ref. no. 1378

With folding mechanism for easy inspection and cleaning.

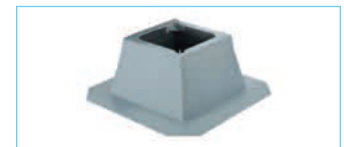

Corrugated roof base

Type WDS 225 Ref. no. 1560

For EC roof fans and roof cowls on corrugated roof, slope to 25° allowed. Made from corrosion resistant glass reinforced polyester (profile no. 5).

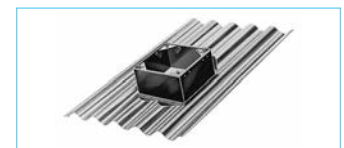

Counterflange

Type FR 225 Ref. no. 1201

Made from galvanised sheet steel, for intake duct connection.



Flanged flexible connector

Type STS 225 Ref. no. 1218

To reduce vibration transmission in intake air ducting. Flanges made of galvanised steel.



Backdraught shutter

Type RVS 225 Ref. no. 2591

Automatic, made from galvanised sheet steel, flaps made of aluminium. To prevent cold air backdraught when the fan is not in use. For vertical air flow bottom-up position.



Motorised backdraught shutter

Type RVM 225 Ref. no. 2575

As RVS, but with spring reversing motor, mounted outside the air flow and for vertical air flow in any direction.



Universal control system

Type EUR EC Ref. no. 1347

For stepless control or adjustment of single and three phase EC-fans with an input control signal of 0–10 V DC.



Speed-potentiometer

Type PU/PA 10 see type table

For direct control or nominal value preset of EC-fans with potentiometer input.



55% Saving*
* with speed control

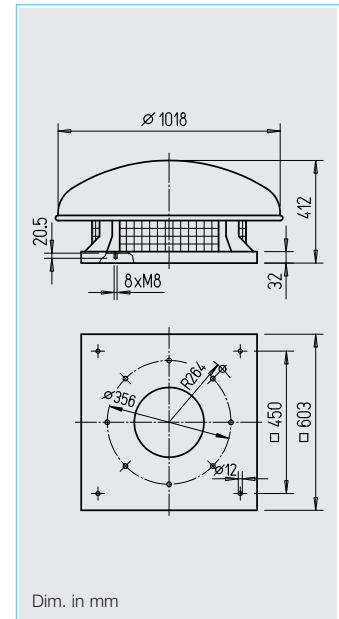
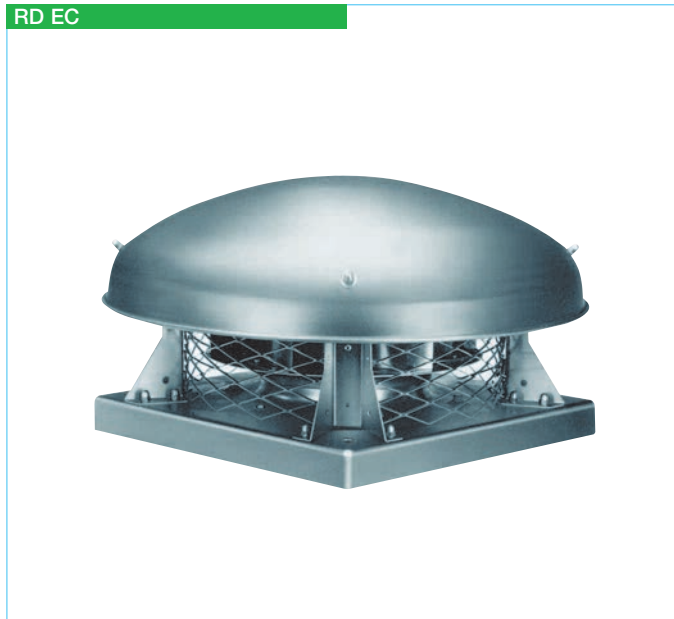

■ Specification

Centrifugal roof fan with horizontal discharge. Flat design with large overlaying rain cowl.

□ Casing

Base plate (with inlet cone) and other parts made of galvanised steel. Rain cowl and protection grille made of aluminium. Base plate with threaded bolt for connection of intake air accessories.

□ Impeller

High performance backward curved centrifugal impeller made of galvanised sheet steel, dynamically balanced with the motor unit.

□ Motor

Energy saving, speed controllable EC-external rotor motor with highest efficiency, protection to IP 44. With ball bearings, maintenance-free and interference-free.

□ Motor protection

Integrated electronic temperature monitoring for EC-motor and electronics.

□ Electrical connection

Terminal box (protection to IP 55) located beneath rain cowl as standard.

□ Guard

On the outlet as standard, compliant with DIN EN ISO 13857.

□ Speed control

Stepless speed control with potentiometer or stepless speed control with universal control system (see table). Duties at different speeds are specified in the performance curve.

□ Delivery

Fully assembled, ready to connect unit.

■ Sound levels

Total sound power levels and the spectrum figures in dB(A) are given for:

- Sound power intake
 - Sound power exhaust
- In the table below as well as underneath the performance curve you can find additionally the sound pressure level at 4 m (free field conditions).

Type	Ref. no.	Connection Ø	R.P.M.	Air flow volume (FID)	Sound press. case breakout	Motor power	Current	Wiring diagram	max. air flow temperature	Weight net approx.	Universal control system		Speed-potentiometer surface			
											Type	Ref. no.	Type	Ref. no.	Type	Ref. no.
Single phase motor, 230 V, 50/60 Hz, EC motor, IP 44																
RDW EC 315	1632	315	1260	4230	52	0.40	1.80	994	40	40.0	EUR EC¹⁾²⁾	1347	PU 10³⁾	1734	PA 10³⁾	1735

1) several EC fans can normally be connected 2) alternative electronic pressure/temperature controller (EDR/ETR, No. 1437/1438) in connection with the power supply NG24, No. 1439, see accessories 3) without LED power supply

RDW EC 315

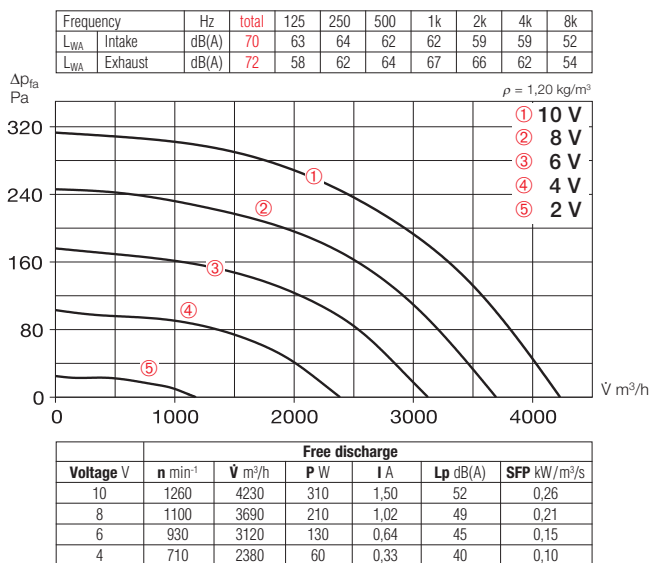

Accessory details Page

Roof mounting accessories	485
Ventilation grilles	487 on
Extract elements	500 on
Intake elements	512 on
Fire protection elements	516 on
Universal control system, electronic controller, speed-potentiometer	539 on

Accessories

Hinged base attenuator

Type SSD 315 Ref. no. 5292

With folding mechanism for easy revision and cleaning. Average attenuation is 15 dB. For intake attenuation. All metal parts made of galvanised sheet steel.



Sloping roof base

Type SDS upon request

For profile and tiled roofs. Made from galvanised sheet steel, with sound and heat-insulated cladding on the inside. Roof pitch up to 45°.

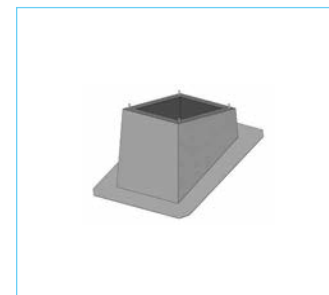

Flat roof base

Type FDS 315 Ref. no. 1379

With folding mechanism for easy inspection and cleaning.

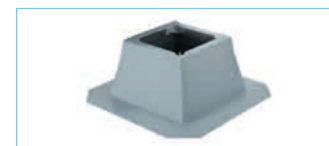

Corrugated roof base

Type WDS 315 Ref. no. 1561

For EC roof fans and roof cowls on corrugated roof, slope to 25° allowed. Made from corrosion resistant glass reinforced polyester (profile no. 5).



Counterflange

Type FR 315 Ref. no. 1204

Made from galvanised sheet steel, for intake duct connection.



Flanged flexible connector

Type STS 315 Ref. no. 1221

To reduce vibration transmission in intake air ducting. Flanges made of galvanised steel.



Backdraught shutter

Type RVS 315 Ref. no. 2594

Automatic, made from galvanised sheet steel, flaps made of aluminium. To prevent cold air backdraught when the fan is not in use. For vertical air flow bottom-up position.



Motorised backdraught shutter

Type RVM 315 Ref. no. 2578

As RVS, but with spring reversing motor, mounted outside the air flow and for vertical air flow in any direction.



Universal control system

Type EUR EC Ref. no. 1347

For stepless control or adjustment of single and three phase EC-fans with an input control signal of 0–10 V DC.



Speed-potentiometer

Type PU/PA 10 see type table

For direct control or nominal value preset of EC-fans with potentiometer input.



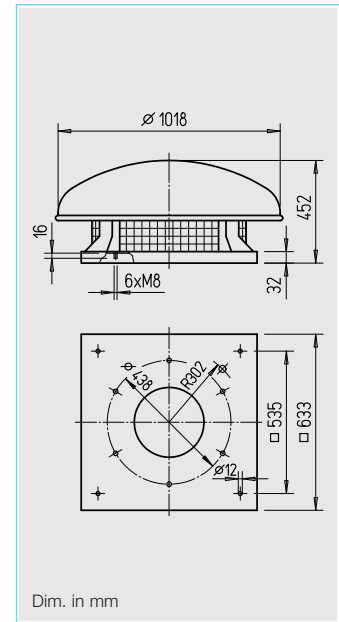
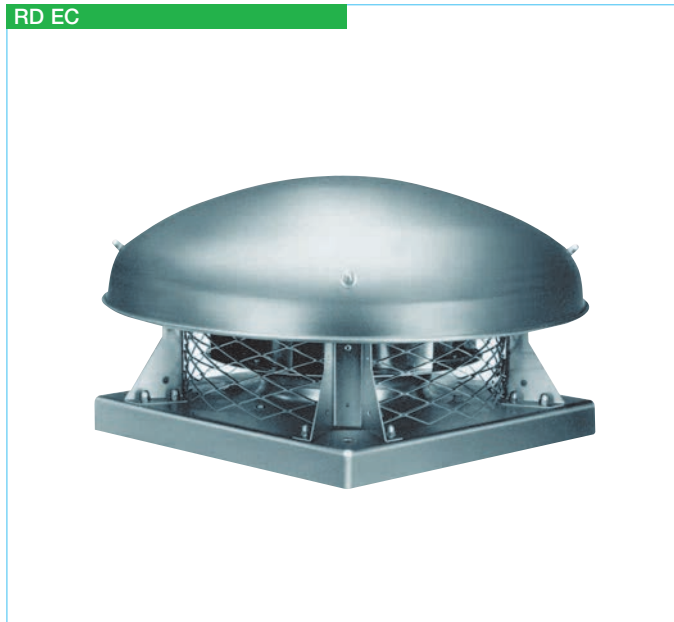

■ Specification

Centrifugal roof fan with horizontal discharge. Flat design with large overlaying rain cowl.

□ Casing

Base plate (with inlet cone) and other parts made of galvanised steel. Rain cowl and protection grille made of aluminium. Base plate with threaded bolt for connection of intake air accessories.

□ Impeller

High performance backward curved centrifugal impeller made of galvanised sheet steel, dynamically balanced with the motor unit.

□ Motor

Energy saving, speed controllable EC-external rotor motor with highest efficiency, protection to IP 44. With ball bearings, maintenance-free and interference-free.

□ Motor protection

Integrated electronic temperature monitoring for EC-motor and electronics.

□ Electrical connection

Terminal box (protection to IP 55) located beneath rain cowl as standard.

□ Guard

On the outlet as standard, compliant with DIN EN ISO 13857.

□ Speed control

Stepless speed control with potentiometer or stepless speed control with universal control system (see table). Duties at different speeds are specified in the performance curve.

□ Delivery

Fully assembled, ready to connect unit.

■ Sound levels

Total sound power levels and the spectrum figures in dB(A) are given for:

- Sound power intake
 - Sound power exhaust
- In the table below as well as underneath the performance curve you can find additionally the sound pressure level at 4 m (free field conditions).

Type	Ref. no.	Connection Ø	R.P.M.	Air flow volume (FID)	Sound press. case breakout	Motor power	Current	Wiring diagram	max. air flow temperature	Weight net approx.	Universal control system		Speed-potentiometer flush		Speed-potentiometer surface	
											Type	Ref. no.	Type	Ref. no.	Type	Ref. no.
Single phase motor, 230 V, 50/60 Hz, EC motor, IP 44																
RDW EC 400	1634	400	1470	6670	59	1.05	4.60	994	40	45.0	EUR EC¹⁾²⁾	1347	PU 10³⁾	1734	PA 10³⁾	1735

1) several EC fans can normally be connected 2) alternative electronic pressure/temperature controller (EDR/ETR, No. 1437/1438) in connection with the power supply NG24, No. 1439, see accessories 3) without LED power supply

RDW EC 400

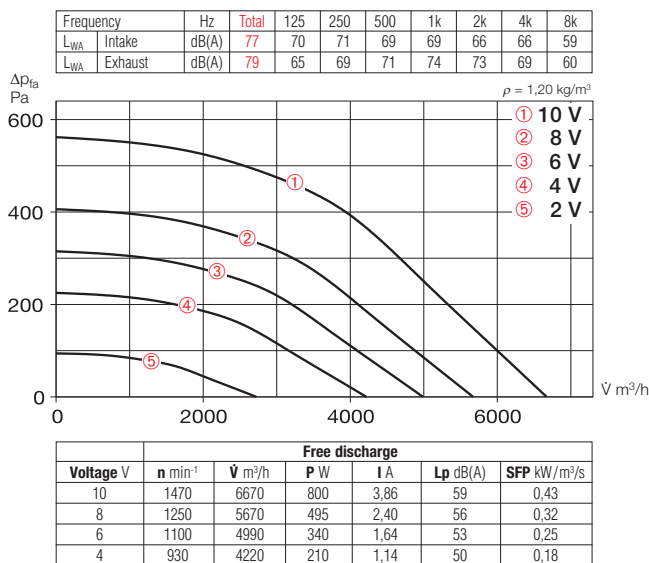

Accessory details Page

Roof mounting accessories	485
Ventilation grilles	487 on
Extract elements	500 on
Intake elements	512 on
Fire protection elements	516 on
Universal control system, electronic controller, speed-potentiometer	539 on

Accessories

Hinged base attenuator

Type SSD 400 Ref. no. 5291

With folding mechanism for easy revision and cleaning. Average attenuation is 15 dB. For intake attenuation. All metal parts made of galvanised sheet steel.



Sloping roof base

Type SDS upon request

For profile and tiled roofs. Made from galvanised sheet steel, with sound and heat-insulated cladding on the inside. Roof pitch up to 45°.

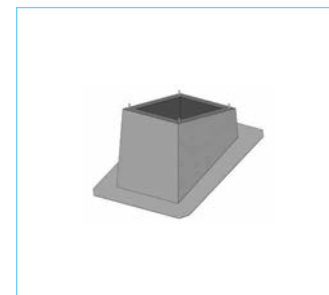

Flat roof base

Type FDS 400 Ref. no. 1380

With folding mechanism for easy inspection and cleaning.

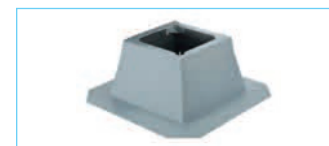

Corrugated roof base

Type WDS 400 Ref. no. 1562

For EC roof fans and roof cowls on corrugated roof, slope to 25° allowed. Made from corrosion resistant glass reinforced polyester (profile no. 5).



Counterflange

Type FR 400 Ref. no. 1206

Made from galvanised sheet steel, for intake duct connection.



Flanged flexible connector

Type STS 400 Ref. no. 1223

To reduce vibration transmission in intake air ducting. Flanges made of galvanised steel.



Backdraught shutter

Type RVS 400 Ref. no. 2596

Automatic, made from galvanised sheet steel, flaps made of aluminium. To prevent cold air backdraught when the fan is not in use. For vertical air flow bottom-up position.



Motorised backdraught shutter

Type RVM 400 Ref. no. 2580

As RVS, but with spring reversing motor, mounted outside the air flow and for vertical air flow in any direction.



Universal control system

Type EUR EC Ref. no. 1347

For stepless control or adjustment of single and three phase EC-fans with an input control signal of 0–10 V DC.



Speed-potentiometer

Type PU/PA 10 see type table

For direct control or nominal value preset of EC-fans with potentiometer input.



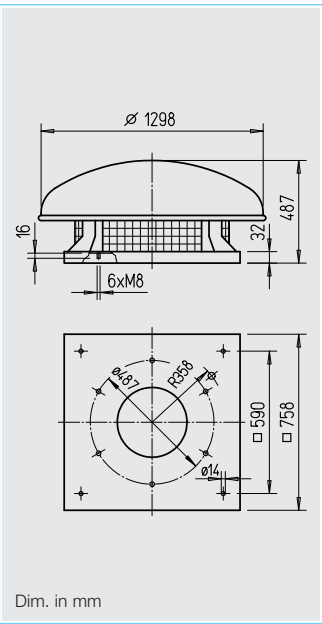
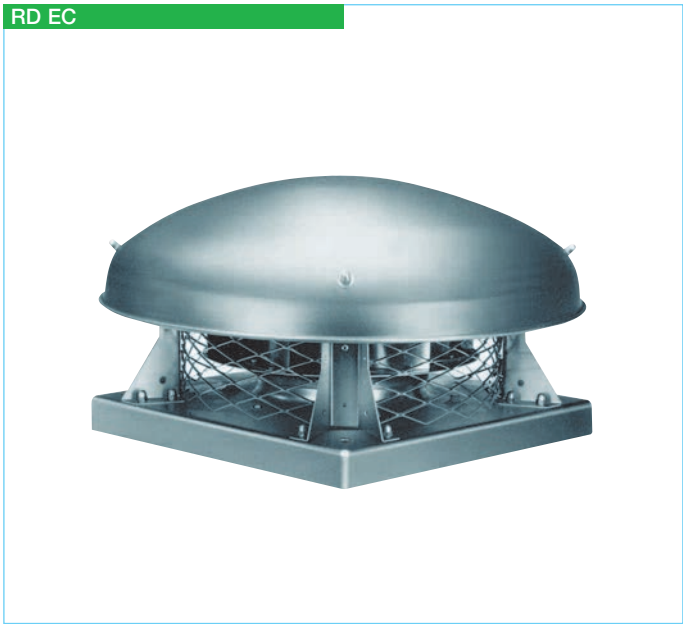

55% Saving*
* with speed control

- Specification**
Centrifugal roof fan with horizontal discharge. Flat design with large overlaying rain cowl.
- Casing**
Base plate (with inlet cone) and other parts made of galvanised steel. Rain cowl and protection grille made of aluminium. Base plate with threaded bolt for connection of intake air accessories.
- Impeller**
High performance backward curved centrifugal impeller made of galvanised sheet steel, dynamically balanced with the motor unit.
- Motor**
Energy saving, speed controllable EC-external rotor motor with highest efficiency, protection to IP 44. With ball bearings, maintenance-free and interference-free.
- Motor protection**
Integrated electronic temperature monitoring for EC-motor and electronics.
- Electrical connection**
Terminal box (protection to IP 55) located beneath rain cowl as standard.
- Guard**
On the outlet as standard, compliant with DIN EN ISO 13857.
- Speed control**
Stepless speed control with potentiometer or stepless speed control with universal control system (see table). Duties at different speeds are specified in the performance curve.
- Delivery**
Fully assembled, ready to connect unit.
- Sound levels**
Total sound power levels and the spectrum figures in dB(A) are given for:
– Sound power intake
– Sound power exhaust
In the table below as well as underneath the performance curve you can find additionally the sound pressure level at 4 m (free field conditions).

Type	Ref. no.	Connection Ø	R.P.M.	Air flow volume (FID)	Sound press. case breakout	Motor power	Current	Wiring diagram	max. air flow temperature	Weight net approx.	Universal control system		Speed-potentiometer flush		Speed-potentiometer surface	
											Type	Ref. no.	Type	Ref. no.	Type	Ref. no.
Single phase motor, 230 V, 50/60 Hz, EC motor, IP 44																
RDW EC 450	1636	450	1180	8360	56	1.02	4.50	994	40	75.0	EUR EC¹⁾²⁾	1347	PU 10³⁾	1734	PA 10³⁾	1735

1) several EC fans can normally be connected 2) alternative electronic pressure/temperature controller (EDR/ETR, No. 1437/1438) in connection with the power supply NG24, No. 1439, see accessories 3) without LED power supply

RDW EC 450

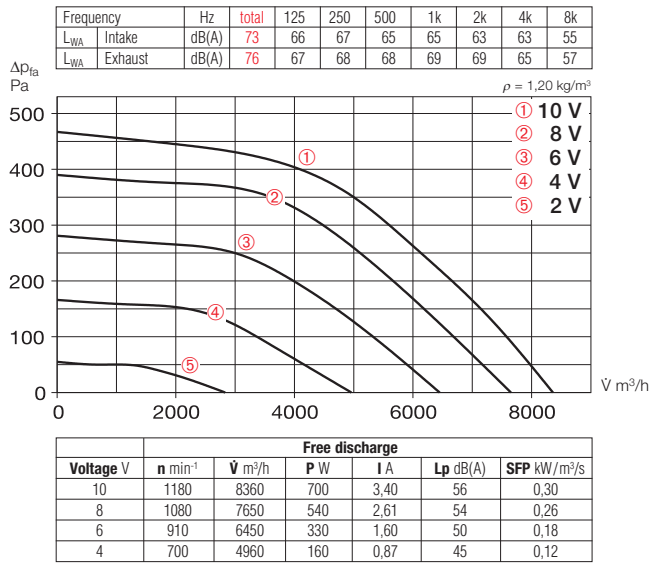

Accessory details Page

Roof mounting accessories	485
Ventilation grilles	487 on
Extract elements	500 on
Intake elements	512 on
Fire protection elements	516 on
Universal control system, electronic controller, speed-potentiometer	539 on

Accessories

Hinged base attenuator

Type SSD 450 Ref. no. 5288

With folding mechanism for easy revision and cleaning. Average attenuation is 15 dB. For intake attenuation. All metal parts made of galvanised sheet steel.



Sloping roof base

Type SDS upon request

For profile and tiled roofs. Made from galvanised sheet steel, with sound and heat-insulated cladding on the inside. Roof pitch up to 45°.

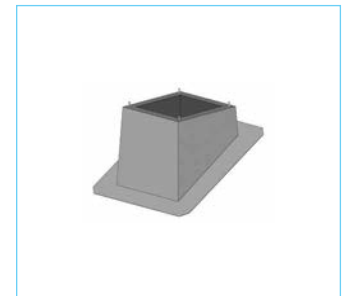

Flat roof base

Type FDS 450 Ref. no. 1381

With folding mechanism for easy inspection and cleaning.

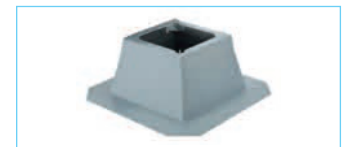

Corrugated roof base

Type WDS 450 Ref. no. 1563

For EC roof fans and roof cowls on corrugated roof, slope to 25° allowed. Made from corrosion resistant glass reinforced polyester (profile no. 5).

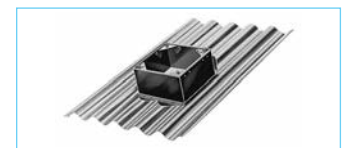

Counterflange

Type FR 450 Ref. no. 1207

Made from galvanised sheet steel, for intake duct connection.



Flanged flexible connector

Type STS 450 Ref. no. 1224

To reduce vibration transmission in intake air ducting. Flanges made of galvanised steel.



Backdraught shutter

Type RVS 450 Ref. no. 2597

Automatic, made from galvanised sheet steel, flaps made of aluminium. To prevent cold air backdraught when the fan is not in use. For vertical air flow bottom-up position.



Motorised backdraught shutter

Type RVM 450 Ref. no. 2581

As RVS, but with spring reversing motor, mounted outside the air flow and for vertical air flow in any direction.



Universal control system

Type EUR EC Ref. no. 1347

For stepless control or adjustment of single and three phase EC-fans with an input control signal of 0–10 V DC.



Speed-potentiometer

Type PU/PA 10 see type table

For direct control or nominal value preset of EC-fans with potentiometer input.



Vertical VDR

■ **Specification**

Vertical discharge centrifugal roof fan.

■ **Casing**

Base plate, casing and other components made of galvanised sheet steel. Base plate supplied with drilled holes in order to connect in-take accessories.

■ **Impeller**

High-performance centrifugal impeller with backward curved blades made of polymer, dynamically balanced together with the motor.

■ **Motor**

Totally enclosed ball bearing mounted external rotor motor (IP 44), with moisture protection. Maintenance-free and interference-free.

■ **Motor protection**

Through built-in thermal contacts, which are wired in series with the winding and automatically switch off at high motor temperatures and back on again after cooling.

■ **Electrical connection**

Standard isolator on outside of casing, factory-wired.

VDRW 180

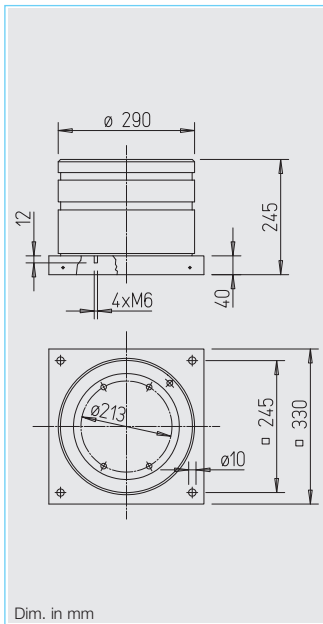

Dim. in mm

VDRW 200

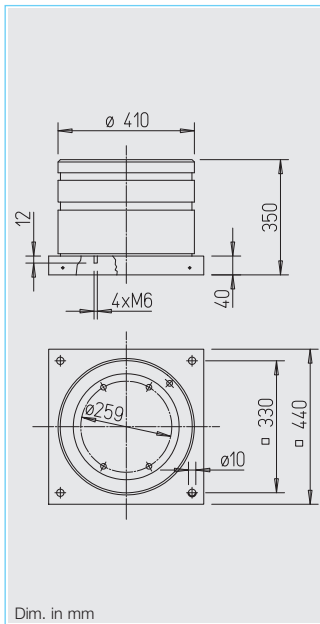

Dim. in mm

■ **Speed control**

All types are steplessly speed controllable in the range from 0 – 100 % by electronic speed controller or 5-step controller.

■ **Sound levels**

The sound pressure in dB(A) at a distance of 4 m is specified on the performance curve. The sum levels and spectrum figures are specified for sound pressure and sound power above the performance curve.

■ **Delivery**

Ready-to-connect, completely pre-assembled in shipping carton.

Information	Page
Information for planning	10 on
Technical description	438
Selection chart	441
Accessories, details	485
Speed controller and switch	525 on

Accessories for Type VDRW 180

Counterflange FR 180

Ref. no. 1200

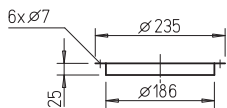

Corrugated roof base, profile 5 WDS 180

Ref. no. 1559

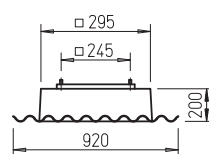

Flanged flexible connector STS 180

Ref. no. 1217

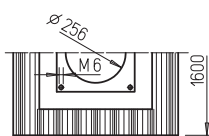
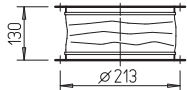

Automatic backdraught shutter DVS 180

Ref. no. 1247

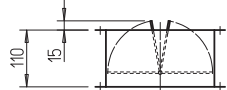

Hinged base attenuator SSD 180

Ref. no. 5289

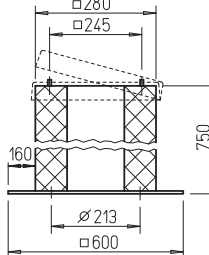

Hinged flat roof base FDS 180

Ref. no. 1377

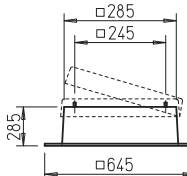

Dim. in mm

Accessories for Type VDRW 200

Counterflange DFR 200

Ref. no. 1201

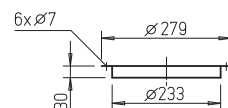

Flanged flexible connector DSTS 200

Ref. no. 1218

For ex-proof fans

DSTS 200 Ex

Ref. no. 2500



Corrugated roof base, profile 5 WDS 200

Ref. no. 1560

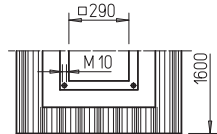
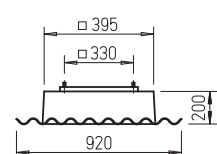

Automatic backdraught shutter DRVS 200

Ref. no. 2591

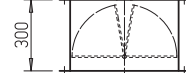

Hinged base attenuator SSD 200

Ref. no. 5290

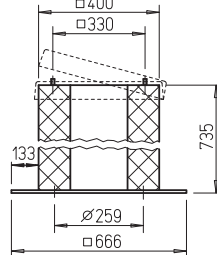

Motorised backdraught shutter DRVM 200

Ref. no. 2575

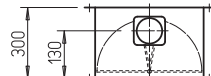

Hinged flat roof base FDS 200

Ref. no. 1378

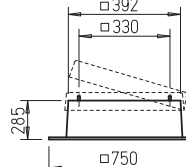

Dim. in mm

VDRW 180/2 C

Frequency	Hz	Total	125	250	500	1k	2k	4k
L _{WA} Intake		dB(A) 61	39	51	54	47	56	53
L _{PA, 4m} Exhaust		dB(A) 48	23	40	42	39	43	41

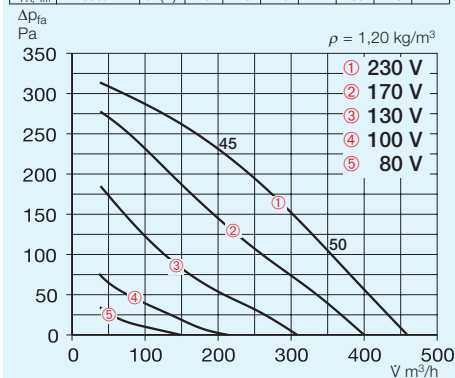

Type	Ref. no.	R.P.M.	Air flow volume (FID)	Sound pressure level	Motor power	Current at full load	Wiring diagram	max. air flow temperature at full load	Weight net	Full motor protection device	5-step speed switch
		min ⁻¹	m ³ /h	dB(A) in 4m	W	A	No.	°C	kg	Type Ref. no.	Type Ref. no.
Single phase motor 230 V, 50 Hz, capacitor motor, protection to IP 44											
VDRW 180/2 C	2794	2480	460	48	55	0.26	826	50	5.5	TSW 0,3 3608	ESU 1/ESA 1 0236/0238

VDRW 200/2 B

Frequency	Hz	Total	125	250	500	1k	2k	4k
L _{WA} Intake		dB(A) 69	49	53	63	66	58	57
L _{PA, 4m} Exhaust		dB(A) 50	19	31	42	46	45	42

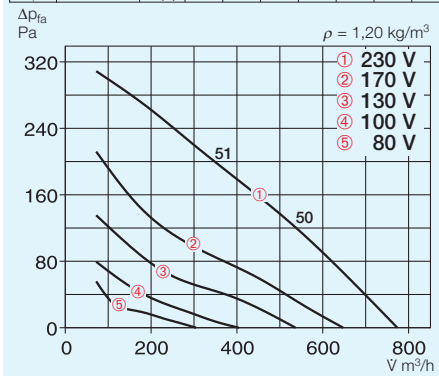

VDRW 200/2 D

Frequency	Hz	Total	125	250	500	1k	2k	4k
L _{WA} Intake		dB(A) 79	62	63	72	77	58	61
L _{PA, 4m} Exhaust		dB(A) 60	31	42	55	53	53	47

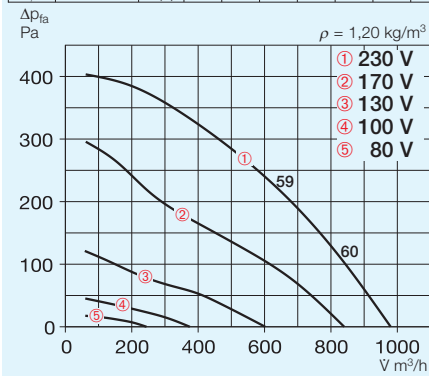

Type	Ref. no.	R.P.M.	Air flow volume (FID)	Sound pressure level	Motor power	Current at full load	Wiring diagram	max. air flow temperature at full load	Weight net	Full motor protection device	5-step speed switch
		min ⁻¹	m ³ /h	dB(A) in 4m	W	A	No.	°C	kg	Type Ref. no.	Type Ref. no.
Single phase motor 230 V, 50 Hz, capacitor motor, protection to IP 44											
VDRW 200/2 B	2795	2600	770	50	85	0.38	826	40	9.5	TSW 1,5 1495	ESU 1/ESA 1 0236/0238
VDRW 200/2 D	2796	2500	990	60	149	0.57	826	70	10.5	TSW 1,5 1495	ESU 1/ESA 1 0236/0238



Series specification

■ Specification RD

Centrifugal roof fan with horizontal discharge and efficiency-optimised aluminium casing and newly developed high-performance centrifugal impeller.

■ Specification VD

Centrifugal roof fan with vertical discharge and efficiency-optimised aluminium casing and newly developed high-performance centrifugal impeller.

Specification for all series

■ Casing

Casing made from seawater-resistant aluminium with integrated protection. Motor base plate and base plate with inlet cone made from galvanised steel. Base plate with threaded bolt for connection of intake air accessories (hole pattern according to DIN 24155).

■ Impeller

High performance backward curved centrifugal impeller made of polymer. Dynamically balanced according to DIN ISO 1940-1.

■ Motor

Totally enclosed speed controllable external rotor (IP 44). Ball bearing mounted with moisture protection. Maintenance-free and interference-free.

■ Motor protection

Through built-in thermal contacts, which are wired in series with the winding and automatically switch off at high motor temperatures and back on again after cooling.

■ Electrical connection

To external terminal box IP 65. Isolator available (see accessories).

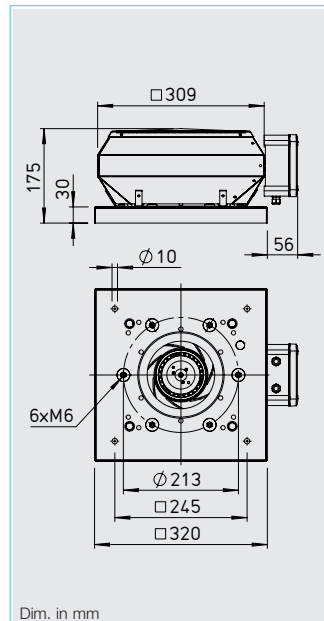
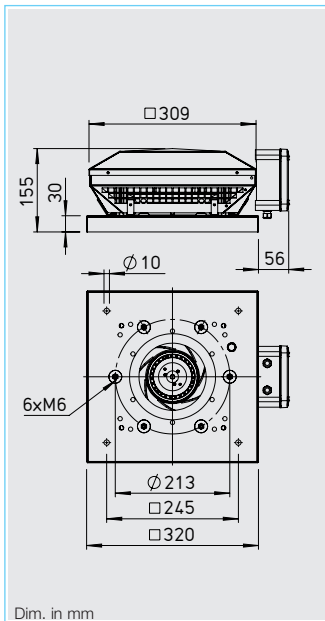

Dim. in mm

Dim. in mm

■ Guard

Standard on the exhaust side according to DIN EN ISO 13857.

■ Speed control

All types are steplessly speed controllable in the range from 0 – 100 % by electronic speed controller or 5-step controller. See type table for assignment.

■ Sound levels

The sum levels and spectrum figures are specified above the performance curve for:
 – Sound level intake
 – Sound level exhaust

The horizontal sound pressure level at 4 m (free field conditions) is also specified in the type table as well as the table below the performance curve.

■ Delivery

Ready-to-connect, completely pre-assembled in shipping carton.

Accessories for Type RD / VD

Counterflange FR 180

Ref. no. 1200

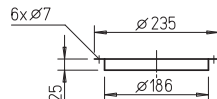

Corrugated roof base, profile 5 WDS 180

Ref. no. 1559

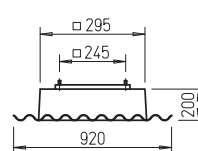

Flanged flexible connector STS 180

Ref. no. 1217

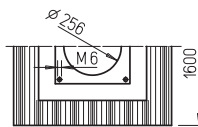
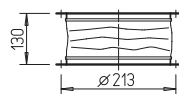

Automatic backdraught shutter DVS 180

Ref. no. 1247

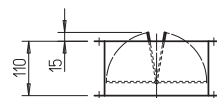

Hinged base attenuator SSD 180

Ref. no. 5289

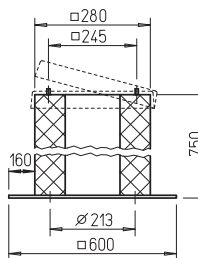

Hinged flat roof base FDS 180

Ref. no. 1377

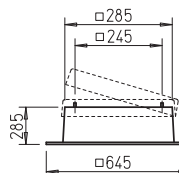

Dim. in mm

Information	Page
Information for planning	10 on
Technical description	438
Selection chart	441
Accessories, details	485
Speed controller and switch	525 on

RDW 180/2

Frequency		Hz	Total	125	250	500	1k	2k	4k
L _{WA}	Intake	dB(A)	61	37	48	53	56	55	54
L _{WA}	Exhaust	dB(A)	65	38	52	58	62	57	54

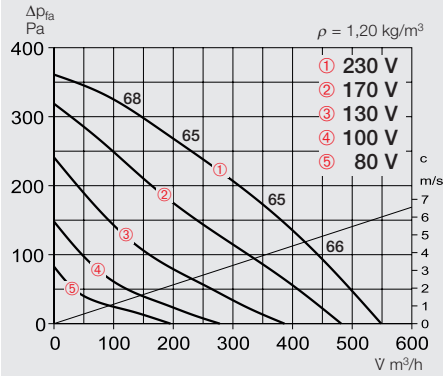

Type	Ref. no.	R.P.M.	Air flow volume (FID)	Sound pressure level	Motor power	Current full load	Current control	Wiring diagram	max. air flow full load	max. air flow temp. control	Weight net	Full motor protection device	5-step speed switch		
		min ⁻¹	m ³ /h	dB(A) in 4m	W	A	A	No.	°C	°C	kg	Type	Ref. no.	Type	Ref. no.
Single phase motor 230 V, 50 Hz, capacitor motor, protection to IP 44															
RDW 180/2	7122	2330	550	48	66	0.3	0.3	923	60	60	4.5	—	—	TSW 1,5	1495

VDW 180/2

Frequency		Hz	Total	125	250	500	1k	2k	4k
L _{WA}	Intake	dB(A)	60	36	47	52	55	54	53
L _{WA}	Exhaust	dB(A)	63	38	51	56	59	57	52

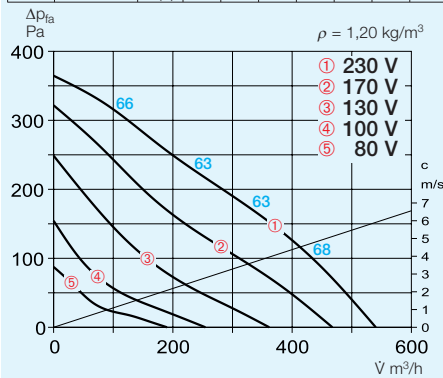

Type	Ref. no.	R.P.M.	Air flow volume (FID)	Sound pressure level	Motor power	Current full load	Current control	Wiring diagram	max. air flow full load	max. air flow temp. control	Weight net	Full motor protection device	5-step speed switch		
		min ⁻¹	m ³ /h	dB(A) in 4m	W	A	A	No.	°C	°C	kg	Type	Ref. no.	Type	Ref. no.
Single phase motor 230 V, 50 Hz, capacitor motor, protection to IP 44															
VDW 180/2	7120	2330	540	46	66	0.3	0.3	923	60	60	5.0	—	—	TSW 1,5	1495



Series specification

■ Specification RD

Centrifugal roof fan with horizontal discharge and efficiency-optimised aluminium casing and newly developed high-performance centrifugal impeller.

■ Specification VD

Centrifugal roof fan with vertical discharge and efficiency-optimised aluminium casing and newly developed high-performance centrifugal impeller.

Specification for all series

■ Casing

Casing made from seawater-resistant aluminium with integrated protection. Motor base plate and base plate with inlet cone made from galvanised steel (inlet cone ex-proof version made from aluminium). Base plate with threaded bolt for connection of intake air accessories (hole pattern according to DIN 24155).

■ Impeller

High performance backward curved centrifugal impeller made of galvanised sheet steel (ex-proof version made from aluminium). Dynamically balanced according to DIN ISO 1940-1.

■ Motor

Totally enclosed speed controllable external rotor (IP 44). Ball bearing mounted with moisture protection. Maintenance-free and interference-free.

■ Motor protection

Through built-in thermal contacts, which are wired in series with the winding and automatically switch off at high motor temperatures and back on again after cooling. Ex-proof version with thermal motor protection from built-in PTC thermistor.

■ Electrical connection

To external terminal box IP 65. Isolator available (see accessories).

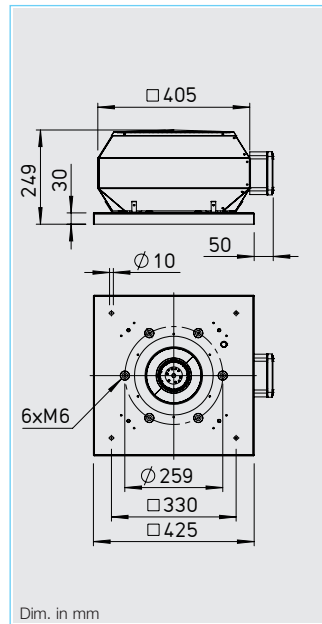
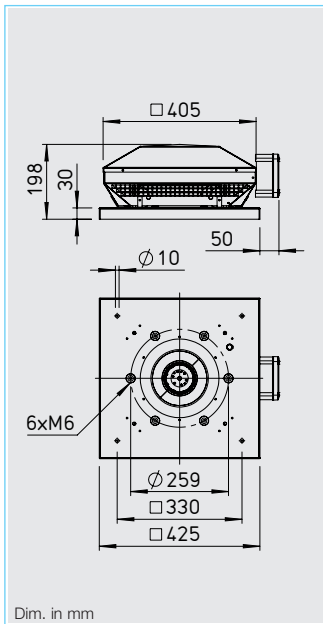

■ Guard

Standard on the exhaust side according to DIN EN ISO 13857.

■ Speed control

All types are steplessly speed controllable in the range from 0 – 100 % by electronic speed controller or 5-step controller. See type table for assignment.

■ Sound levels

The sum levels and spectrum figures are specified above the performance curve for:
 – Sound level intake
 – Sound level exhaust

The horizontal sound pressure level at 4 m (free field conditions) is also specified in the type table as well as the table below the performance curve.

■ Delivery

Ready-to-connect, completely pre-assembled in shipping carton.

Accessories for Type RD / VD

Counterflange DFR 200

Ref. no. 1201

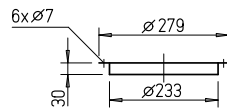

Corrugated roof base, profile 5 WDS 200

Ref. no. 1560

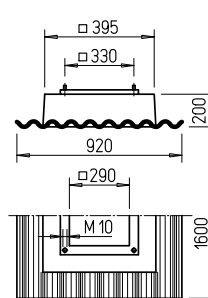

Flanged flexible connector DSTS 200

Ref. no. 1218

For ex-proof fans

DSTS 200 Ex

Ref. no. 2500

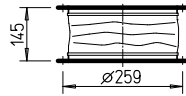

Automatic backdraught shutter DRVS 200

Ref. no. 2591

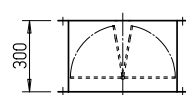

Hinged base attenuator SSD 200

Ref. no. 5290

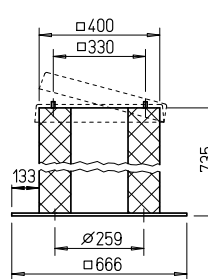

Motorised backdraught shutter DRVM 200

Ref. no. 2575

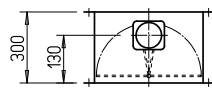

Hinged flat roof base FDS 200

Ref. no. 1378

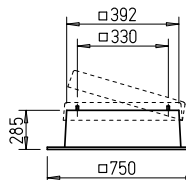

Dim. in mm

Information	Page
Information for planning	10 on
Technical description	438
Selection chart	441
Accessories, details	485
Speed controller and switch	525 on

RDW 200/2

Frequency	Hz	Total	125	250	500	1k	2k	4k	
L _{WA} Intake		dB(A)	68	44	57	61	63	60	60
L _{WA} Exhaust		dB(A)	71	45	62	66	65	62	62

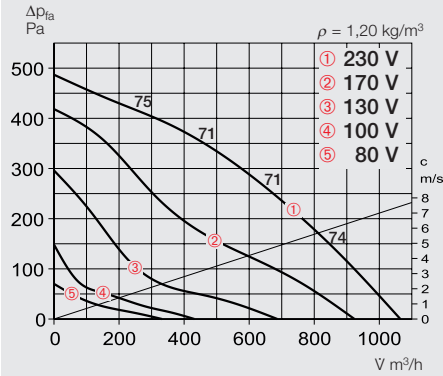

RDW 200/4

Frequency	Hz	Total	125	250	500	1k	2k	4k	
L _{WA} Intake		dB(A)	56	32	45	49	51	48	48
L _{WA} Exhaust		dB(A)	59	33	50	54	53	50	50

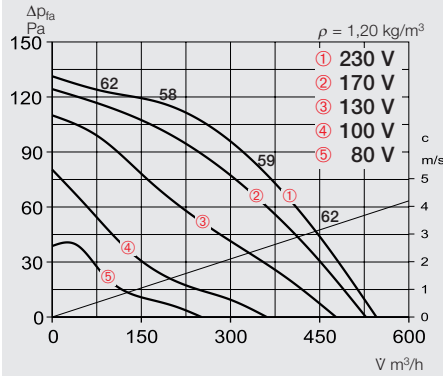

Type	Ref. no.	R.P.M.	Air flow volume (FID)	Sound pressure level	Motor power	Current full load	Current control	Wiring diagram	max. air flow temp. full load	Weight net	Full motor protection device		5-step speed switch		
											Type	Ref. no.	Type	Ref. no.	
		min ⁻¹	m ³ /h	dB(A) in 4m	W	A	A	No.	°C	°C	kg				
Single phase motor 230 V, 50 Hz, capacitor motor, protection to IP 44															
RDW 200/4	7177	1375	545	42	34	0.16	0.16	923	70	70	7.0	—	—	TSW 1,5	1495
RDW 200/2	7176	2430	1070	54	125	0.56	0.56	923	70	70	7.5	—	—	TSW 1,5	1495
Explosion-proof, three phase motor 400 V, 50 Hz, protection to IP 44, temp. class T1-T3															
RDD 200/4 Ex ¹⁾	7191	1465	770	42	75	0.32	0.32	1129	40	40	7.0	MSA	1289	TSD 0,8	1500

1) Performance curve on www.HeliosSelect.de

VDW 200/2

Frequency	Hz	Total	125	250	500	1k	2k	4k	
L _{WA} Intake		dB(A)	68	43	58	60	63	61	60
L _{WA} Exhaust		dB(A)	70	46	63	64	63	62	61

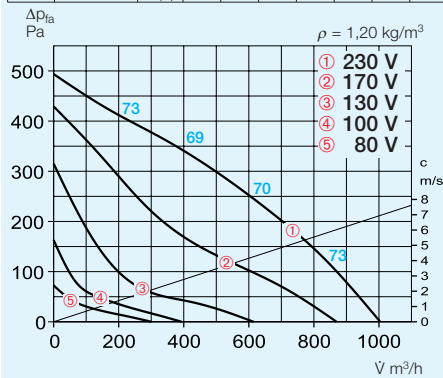

VDW 200/4

Frequency	Hz	Total	125	250	500	1k	2k	4k	
L _{WA} Intake		dB(A)	52	35	41	47	46	44	44
L _{WA} Exhaust		dB(A)	54	38	47	49	46	46	45

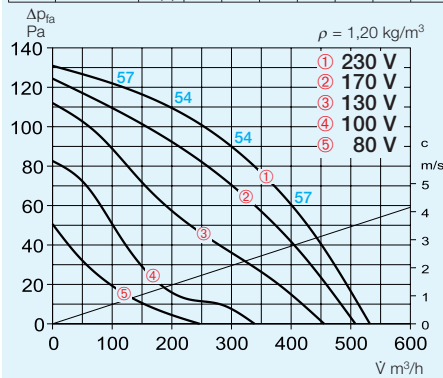

Type	Ref. no.	R.P.M.	Air flow volume (FID)	Sound pressure level	Motor power	Current full load	Current control	Wiring diagram	max. air flow temp. full load	Weight net	Full motor protection device		5-step speed switch		
											Type	Ref. no.	Type	Ref. no.	
		min ⁻¹	m ³ /h	dB(A) in 4m	W	A	A	No.	°C	°C	kg				
Single phase motor 230 V, 50 Hz, capacitor motor, protection to IP 44															
VDW 200/4	7134	1375	535	37	34	0.16	0.16	923	70	70	7.5	—	—	TSW 1,5	1495
VDW 200/2	7126	2430	1000	53	125	0.56	0.56	923	70	70	8.0	—	—	TSW 1,5	1495
Explosion-proof, three phase motor 400 V, 50 Hz, protection to IP 44, temp. class T1-T3															
VDD 200/4 Ex ¹⁾	7178	1465	750	37	75	0.32	0.32	1129	40	40	7.5	MSA	1289	TSD 0,8	1500

1) Performance curve on www.HeliosSelect.de



Series specification

■ Specification RD

Centrifugal roof fan with horizontal discharge and efficiency-optimised aluminium casing and newly developed high-performance centrifugal impeller.

■ Specification VD

Centrifugal roof fan with vertical discharge and efficiency-optimised aluminium casing and newly developed high-performance centrifugal impeller.

Specification for all series

■ Casing

Casing made from seawater-resistant aluminium with integrated protection. Motor base plate and base plate with inlet cone made from galvanised steel (inlet cone ex-proof version made from aluminium). Base plate with threaded bolt for connection of intake air accessories (hole pattern according to DIN 24155).

■ Impeller

High performance backward curved centrifugal impeller made of galvanised sheet steel (ex-proof version made from aluminium). Dynamically balanced according to DIN ISO 1940-1.

■ Motor

Totally enclosed speed controllable external rotor (IP 44). Ball bearing mounted with moisture protection. Maintenance-free and interference-free.

■ Motor protection

Through built-in thermal contacts, which are wired in series with the winding and automatically switch off at high motor temperatures and back on again after cooling. Ex-proof version with thermal motor protection from built-in PTC thermistor.

■ Electrical connection

To external terminal box IP 65. Isolator available (see accessories).

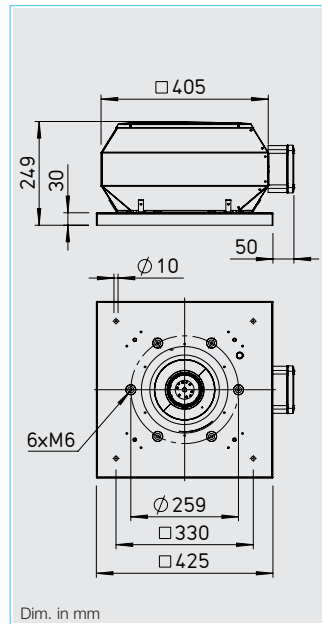
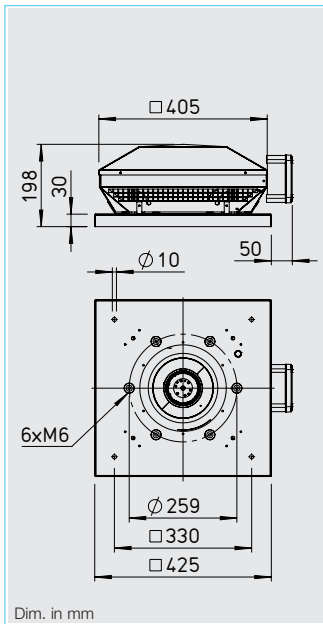

■ Guard

Standard on the exhaust side according to DIN EN ISO 13857.

■ Speed control

All types are steplessly speed controllable in the range from 0 – 100 % by electronic speed controller or 5-step controller. See type table for assignment.

■ Sound levels

The sum levels and spectrum figures are specified above the performance curve for:
– Sound level intake
– Sound level exhaust

The horizontal sound pressure level at 4 m (free field conditions) is also specified in the type table as well as the table below the performance curve.

■ Delivery

Ready-to-connect, completely pre-assembled in shipping carton.

Accessories for Type RD / VD

Counterflange FR 225 Ref. no. 1201

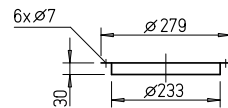

Corrugated roof base, profile 5 WDS 225 Ref. no. 1560

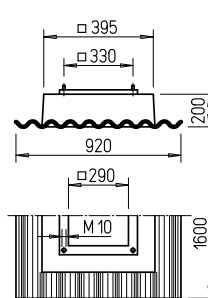

Flanged flexible connector STS 225 Ref. no. 1218

For ex-proof fans

STS 225 Ex Ref. no. 2500

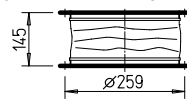

Automatic backdraught shutter RVS 225 Ref. no. 2591

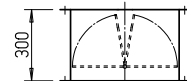

Hinged base attenuator SSD 225 Ref. no. 5290

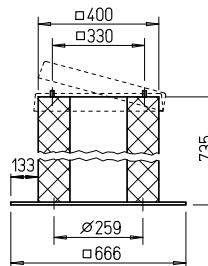

Motorised backdraught shutter RVM 225 Ref. no. 2575

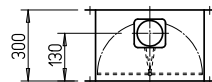

Hinged flat roof base FDS 225 Ref. no. 1378

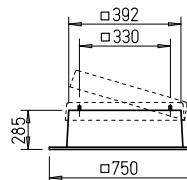

Information	Page
Information for planning	10 on
Technical description	438
Selection chart	441
Accessories, details	485
Speed controller and switch	525 on

Dim. in mm

RDW 225/2

Frequency	Hz	Total	125	250	500	1k	2k	4k
L _{WA} Intake		dB(A) 72	46	62	65	67	64	64
L _{WA} Exhaust		dB(A) 75	50	65	69	70	67	66

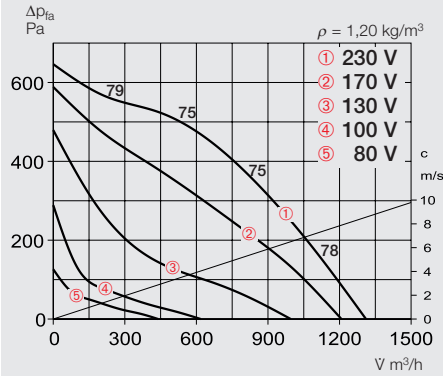

RDW 225/4

Frequency	Hz	Total	125	250	500	1k	2k	4k
L _{WA} Intake		dB(A) 56	39	45	50	51	48	48
L _{WA} Exhaust		dB(A) 60	40	51	57	53	49	49

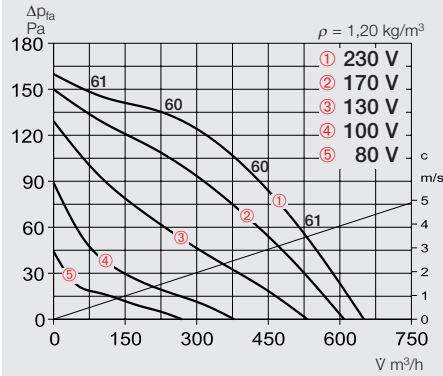

Type	Ref. no.	R.P.M.	Air flow volume (FID)	Sound pressure level	Motor power	Current full load	Current control	Wiring diagram	max. air flow temp. full load	Weight net	Full motor protection device		5-step speed switch		
											Type	Ref. no.	Type	Ref. no.	
		min ⁻¹	m ³ /h	dB(A) in 4m	W	A	A	No.	°C	°C	kg	Type	Ref. no.	Type	Ref. no.
Single phase motor 230 V, 50 Hz, capacitor motor, protection to IP 44															
RDW 225/4	7235	1340	650	43	43	0.2	0.2	923	70	70	6.5	—	—	TSW 1,5	1495
RDW 225/2	7234	2635	1330	58	208	0.9	1	923	70	70	7.5	—	—	TSW 1,5	1495
Explosion-proof, three phase motor 400 V, 50 Hz, protection to IP 44, temp. class T1-T3															
RDD 225/4 Ex ¹⁾	7239	1450	1050	43	80	0.35	0.35	1129	40	40	6.5	MSA	1289	TSD 0,8	1500

1) Performance curve on www.HeliosSelect.de

VDW 225/2

Frequency	Hz	Total	125	250	500	1k	2k	4k
L _{WA} Intake		dB(A) 71	47	61	64	66	63	63
L _{WA} Exhaust		dB(A) 73	50	64	66	66	67	65

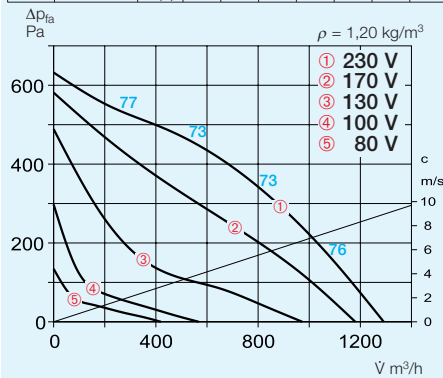

VDW 225/4

Frequency	Hz	Total	125	250	500	1k	2k	4k
L _{WA} Intake		dB(A) 57	33	47	50	52	49	49
L _{WA} Exhaust		dB(A) 59	36	50	52	52	53	51

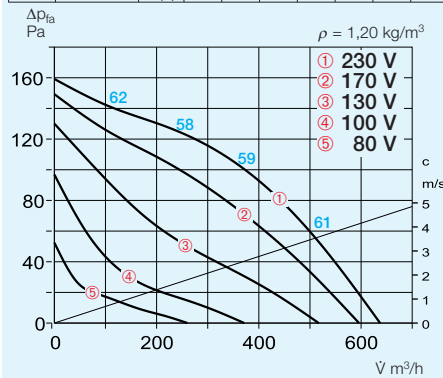

Type	Ref. no.	R.P.M.	Air flow volume (FID)	Sound pressure level	Motor power	Current full load	Current control	Wiring diagram	max. air flow temp. full load	Weight net	Full motor protection device		5-step speed switch		
											Type	Ref. no.	Type	Ref. no.	
		min ⁻¹	m ³ /h	dB(A) in 4m	W	A	A	No.	°C	°C	kg	Type <td>Ref. no.</td> <td>Type</td> <td>Ref. no.</td>	Ref. no.	Type	Ref. no.
Single phase motor 230 V, 50 Hz, capacitor motor, protection to IP 44															
VDW 225/4	7221	1340	640	42	43	0.2	0.2	923	70	70	8.0	—	—	TSW 1,5	1495
VDW 225/2	7196	2635	1295	56	208	0.9	1	923	70	70	9.0	—	—	TSW 1,5	1495
Explosion-proof, three phase motor 400 V, 50 Hz, protection to IP 44, temp. class T1-T3															
VDD 225/4 Ex ¹⁾	7237	1450	1025	42	80	0.35	0.35	1129	40	40	8.0	MSA	1289	TSD 0,8	1500

1) Performance curve on www.HeliosSelect.de



Series specification

■ Specification RD

Centrifugal roof fan with horizontal discharge and efficiency-optimised aluminium casing and newly developed high-performance centrifugal impeller.

■ Specification VD

Centrifugal roof fan with vertical discharge and efficiency-optimised aluminium casing and newly developed high-performance centrifugal impeller.

Specification for all series

■ Casing

Casing made from seawater-resistant aluminium with integrated protection. Motor base plate and base plate with inlet cone made from galvanised steel (inlet cone ex-proof version made from aluminium). Base plate with threaded bolt for connection of intake air accessories (hole pattern according to DIN 24155).

■ Impeller

High performance backward curved centrifugal impeller made of galvanised sheet steel (ex-proof version made from aluminium). Dynamically balanced according to DIN ISO 1940-1.

■ Motor

Totally enclosed speed controllable external rotor (IP 44). Ball bearing mounted with moisture protection. Maintenance-free and interference-free.

■ Motor protection

Through built-in thermal contacts, which are wired in series with the winding and automatically switch off at high motor temperatures and back on again after cooling. Ex-proof version with thermal motor protection from built-in PTC thermistor.

■ Electrical connection

To external terminal box IP 65. Isolator available (see accessories).

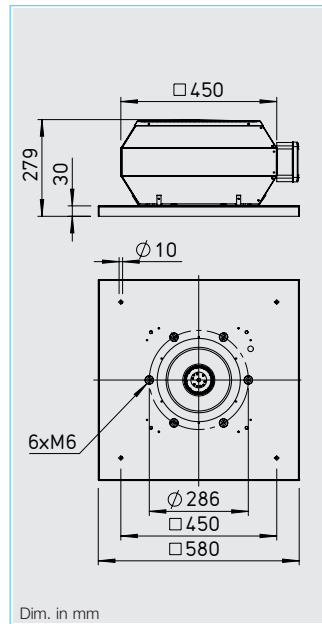
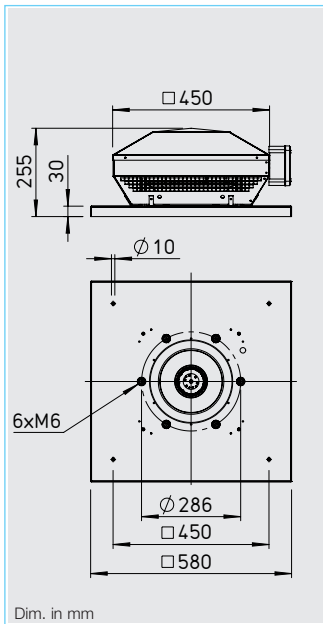

■ Guard

Standard on the exhaust side according to DIN EN ISO 13857.

■ Speed control

All types are steplessly speed controllable in the range from 0 – 100 % by electronic speed controller or 5-step controller. See type table for assignment.

■ Sound levels

The sum levels and spectrum figures are specified above the performance curve for:
 – Sound level intake
 – Sound level exhaust

The horizontal sound pressure level at 4 m (free field conditions) is also specified in the type table as well as the table below the performance curve.

■ Delivery

Ready-to-connect, completely pre-assembled in shipping carton.

Accessories for Type RD / VD

Counterflange FR 250 Ref. no. 1203

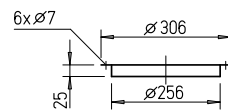

Corrugated roof base, profile 5 WDS 250 Ref. no. 1561

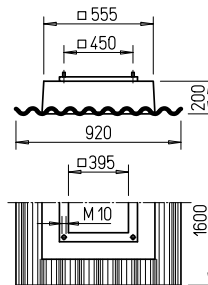

Flanged flexible connector STS 250 Ref. no. 1220

For ex-proof fans
STS 250 Ex Ref. no. 2501

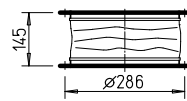

Automatic backdraught shutter RVS 250 Ref. no. 2592

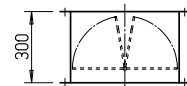

Hinged base attenuator SSD 250 Ref. no. 5292

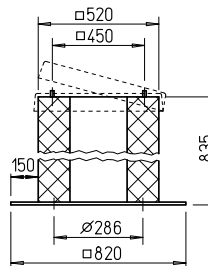

Motorised backdraught shutter RVM 250 Ref. no. 2576

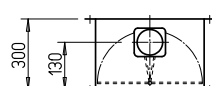

Hinged flat roof base FDS 250 Ref. no. 1379

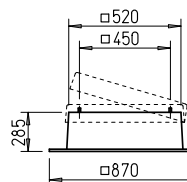

Dim. in mm

Information	Page
Information for planning	10 on
Technical description	438
Selection chart	441
Accessories, details	485
Speed controller and switch	525 on

RDW 250/4

Frequency	Hz	Total	125	250	500	1k	2k	4k	
L _{WA} Intake		dB(A)	58	46	48	52	52	50	50
L _{WA} Exhaust		dB(A)	61	50	52	55	54	54	52

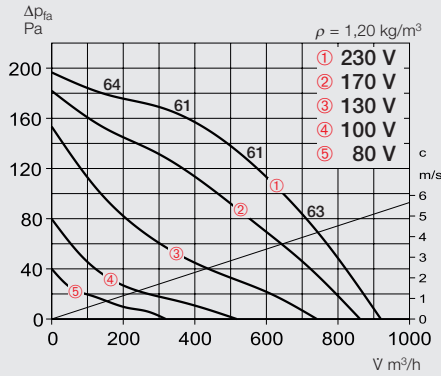

Type	Ref. no.	R.P.M.	Air flow volume (FID)	Sound pressure level	Motor power	Current full load	Current control	Wiring diagram	max. air flow temp. full load	max. air flow temp. control	Weight net	Full motor protection device	5-step speed switch		
		min ⁻¹	m ³ /h	dB(A) in 4m	W	A	A	No.	°C	°C	kg	Type	Ref. no.	Type	Ref. no.
Single phase motor 230 V, 50 Hz, capacitor motor, protection to IP 44															
RDW 250/4	7264	1340	920	44	63	0.28	0.28	923	70	70	11.0	—	—	TSW 1,5	1495
Explosion-proof, three phase motor 400 V, 50 Hz, protection to IP 44, temp. class T1-T3															
RDD 250/4 Ex ¹⁾	7273	1390	1480	44	121	0.36	0.36	1129	40	40	11.0	MSA	1289	TSD 0,8	1500

1) Performance curve on www.HeliosSelect.de

VDW 250/4

Frequency	Hz	Total	125	250	500	1k	2k	4k	
L _{WA} Intake		dB(A)	58	40	49	51	52	51	51
L _{WA} Exhaust		dB(A)	60	47	52	54	53	52	52

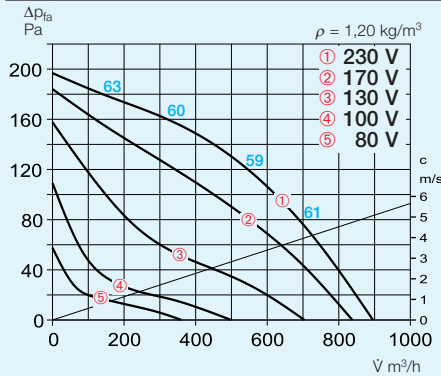

Type	Ref. no.	R.P.M.	Air flow volume (FID)	Sound pressure level	Motor power	Current full load	Current control	Wiring diagram	max. air flow temp. full load	max. air flow temp. control	Weight net	Full motor protection device	5-step speed switch		
		min ⁻¹	m ³ /h	dB(A) in 4m	W	A	A	No.	°C	°C	kg	Type	Ref. no.	Type	Ref. no.
Single phase motor 230 V, 50 Hz, capacitor motor, protection to IP 44															
VDW 250/4	7244	1340	900	43	63	0.28	0.28	923	70	70	11.5	—	—	TSW 1,5	1495
Explosion-proof, three phase motor 400 V, 50 Hz, protection to IP 44, temp. class T1-T3															
VDD 250/4 Ex ¹⁾	7265	1390	1440	43	121	0.36	0.36	1129	40	40	11.5	MSA	1289	TSD 0,8	1500

1) Performance curve on www.HeliosSelect.de

Series specification

■ Specification RD

Centrifugal roof fan with horizontal discharge and efficiency-optimised aluminium casing and newly developed high-performance centrifugal impeller.

■ Specification VD

Centrifugal roof fan with vertical discharge and efficiency-optimised aluminium casing and newly developed high-performance centrifugal impeller.

■ Special feature VD T120

Designed for moving process air up to +120 °C. Encapsulated motor located outside of air flow.

Specification for all series

■ Casing

Casing made from seawater-resistant aluminium with integrated protection. Motor base plate and base plate with inlet cone made from galvanised steel (inlet cone ex-proof version made from aluminium). Base plate with threaded bolt for connection of intake air accessories (hole pattern according to DIN 24155).

■ Impeller

High performance backward curved centrifugal impeller made of polymer (T120 and ex-proof version made from aluminium). Dynamically balanced according to DIN ISO 1940-1.

■ Motor

Totally enclosed speed controllable external rotor motor IP 54 (Ex-proof version in IP 44). Flange motor with self-ventilation (T120 version) in IP 54. Ball bearing mounted with moisture protection. Maintenance-free and interference-free.

■ Motor protection

Through built-in thermal contacts or built-in PTC thermistor, which must be connected to a full motor protection device. See type table for assignment.

■ Electrical connection

Without dismantling the casing, to external isolator (ex-proof version to terminal box) protected to IP 65.

■ Guard

Standard on the exhaust side according to DIN EN ISO 13857.

■ Speed control

All 1~ types are steplessly speed controllable in the range from 0 – 100 % through electronic speed switch or five-step controller. All 3~ types are steplessly speed controllable in the range from 0 – 100 % with a frequency inverter with integrated all-pole Sine filter (except ex-proof version) or

Horizontal discharge RD

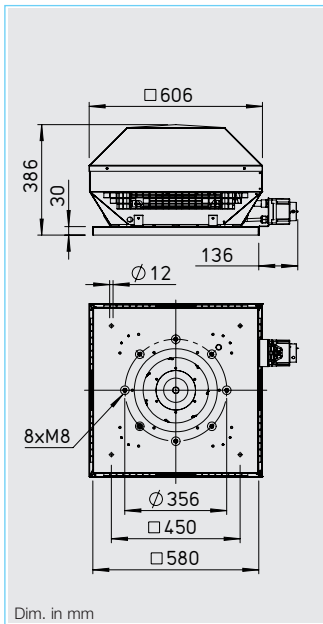

Dim. in mm

Vertical discharge VD

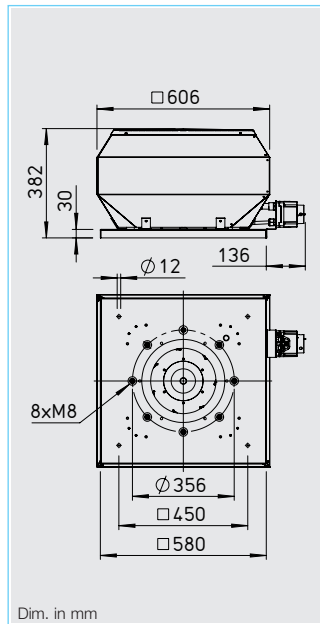

Dim. in mm

VD T120

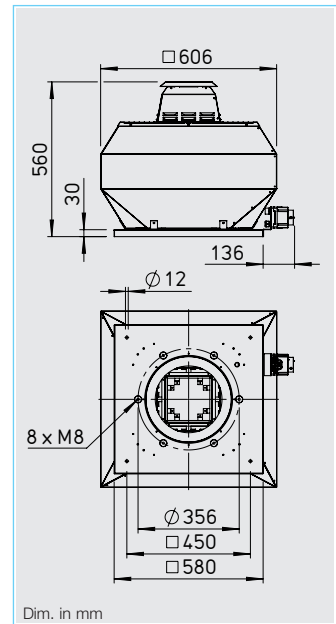

Dim. in mm

Accessories for Type RD / VD*

Counterflange FR 315

Ref. no. 1204

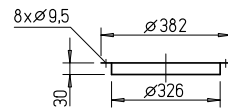

Flanged flexible connector STS 315

Ref. no. 1221

For ex-proof fans

STS 315 Ex Ref. no. 2503

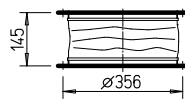

Automatic backdraught shutter RVS 315

Ref. no. 2594

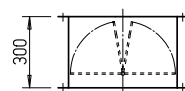

Motorised backdraught shutter RVM 315

Ref. no. 2578

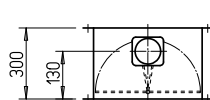

Hinged flat roof base FDS 315

Ref. no. 1379

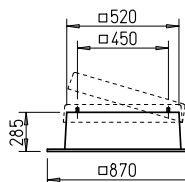

Corrugated roof base, profile 5 WDS 315

Ref. no. 1561

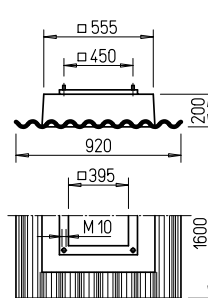

Hinged base attenuator SSD 315

Ref. no. 5292

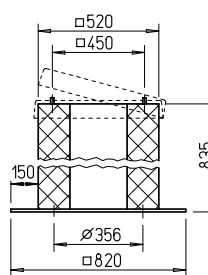

Roof fan attenuator HSDV 315

Ref. no. 7476

only for type VD

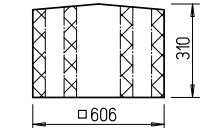

Dim. in mm

five-step controllers. See table for assignment.

■ Sound levels

The sum levels and spectrum figures are specified above the performance curve for:
– Sound level intake
– Sound level exhaust

The horizontal sound pressure level at 4 m (free field conditions) is also specified in the type table as well as the table below the performance curve.

■ Delivery

Ready-to-connect, completely pre-assembled in shipping carton.

Information	Page
Information for planning	10 on
Technical description	438
Selection chart	441
Accessories, details	485
Speed controller and switch	525 on

* Accessory VD T120 see installation accessories p. 485 Other accessories upon request.

RDW 315/4

Frequency	Hz	Total	125	250	500	1k	2k	4k
L _{WA} Intake		dB(A) 66	54	58	60	58	59	58
L _{WA} Exhaust		dB(A) 68	55	62	63	62	58	50

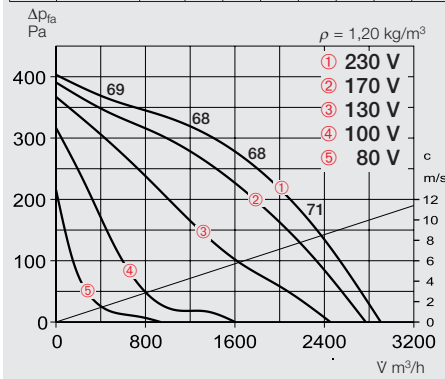

RDD 315/4

Frequency	Hz	Total	125	250	500	1k	2k	4k
L _{WA} Intake		dB(A) 66	53	57	59	57	58	57
L _{WA} Exhaust		dB(A) 68	55	61	62	61	57	49

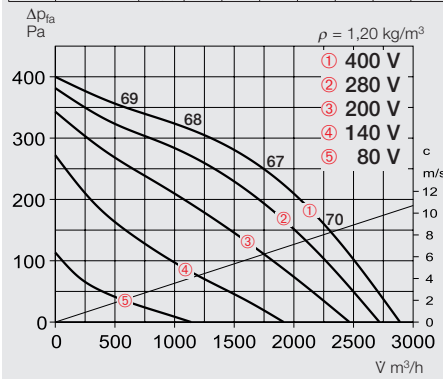

Type	Ref. no.	R.P.M.	Air flow volume (FID)	Sound pressure level	Motor power	Current full load	Current control	Wiring diagram	max. air flow temp. full load	Weight net	Full motor protection device		5-step speed switch		
											Type	Ref. no.	Type	Ref. no.	
		min ⁻¹	m ³ /h	dB(A) in 4m	W	A	A	No.	°C	°C	kg	Type	Ref. no.	Type	Ref. no.
Single phase motor 230 V, 50 Hz, capacitor motor, protection to IP 54															
RDW 315/4	7287	1385	2900	51	300	1.5	2.0	1128	60	50	20.5	MW	1579	MWS 3 ²⁾	1948
Three phase motor 400 V, 50 Hz, squirrel-cage rotor, protection to IP 54															
RDD 315/4	7288	1385	2890	51	290	0.67	0.67	1129	65	65	19.5	MD	5849	RDS 1 ²⁾	1314
Explosion-proof, three phase motor 400 V, 50 Hz, protection to IP 44, temp. class T1-T3															
RDD 315/4 Ex ¹⁾	7303	1380	2980	51	320	0.74	0.74	1129	40	40	19.5	MSA	1289	TSD 1,5	1501

1) Performance curve on www.HeliosSelect.de 2) includes full motor protection device

VDW 315/4

Frequency	Hz	Total	125	250	500	1k	2k	4k
L _{WA} Intake		dB(A) 66	53	57	59	57	58	57
L _{WA} Exhaust		dB(A) 69	58	61	62	63	58	53

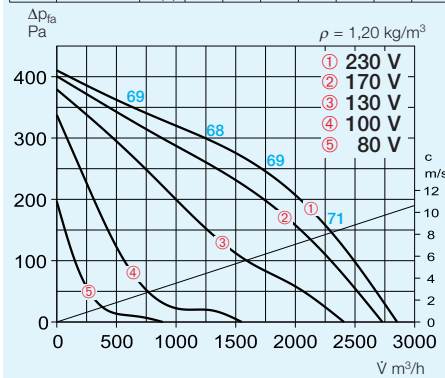

VDD 315/4

Frequency	Hz	Total	125	250	500	1k	2k	4k
L _{WA} Intake		dB(A) 65	53	57	59	57	58	57
L _{WA} Exhaust		dB(A) 68	58	61	62	63	58	52

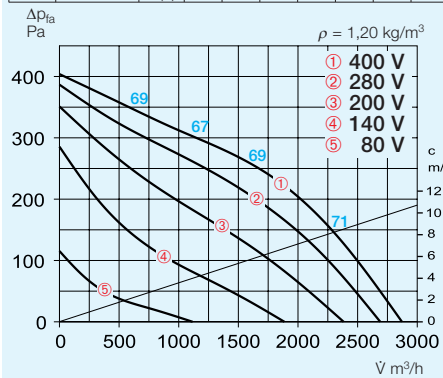

Type	Ref. no.	R.P.M.	Air flow volume (FID)	Sound pressure level	Motor power	Current full load	Current control	Wiring diagram	max. air flow temp. full load	Weight net	Full motor protection device		5-step speed switch		
											Type	Ref. no.	Type	Ref. no.	
		min ⁻¹	m ³ /h	dB(A) in 4m	W	A	A	No.	°C	°C	kg	Type	Ref. no.	Type	Ref. no.
Single phase motor 230 V, 50 Hz, capacitor motor, protection to IP 54															
VDW 315/4	7279	1385	2860	52	300	1.5	2.0	1128	60	50	21.0	MW	1579	MWS 3 ²⁾	1948
Three phase motor 400 V, 50 Hz, squirrel-cage rotor, protection to IP 54															
VDD 315/4	7282	1385	2880	51	290	0.67	0.67	1129	65	65	20.0	MD	5849	RDS 1 ²⁾	1314
Explosion-proof, three phase motor 400 V, 50 Hz, protection to IP 44, temp. class T1-T3															
VDD 315/4 Ex ¹⁾	7293	1380	2930	52	320	0.74	0.74	1129	40	40	20.0	MSA	1289	TSD 1,5	1501
Three phase motor 400 V, 50 Hz, squirrel-cage rotor, protection to IP 54															
VDD 315/4 T120 ¹⁾	7315	1445	2855	52	350	0.9	1.1	1129	120	100	25.0	MD	5849	RDS 2 ²⁾	1315

1) Performance curve on www.HeliosSelect.de 2) includes full motor protection device

Series specification

■ Specification RD

Centrifugal roof fan with horizontal discharge and efficiency-optimised aluminium casing and newly developed high-performance centrifugal impeller.

■ Specification VD

Centrifugal roof fan with vertical discharge and efficiency-optimised aluminium casing and newly developed high-performance centrifugal impeller.

■ Special feature VD T120

Designed for moving process air up to +120 °C. Encapsulated motor located outside of air flow.

Specification for all series

■ Casing

Casing made from seawater-resistant aluminium with integrated protection. Motor base plate and base plate with inlet cone made from galvanised steel (inlet cone ex-proof version made from aluminium). Base plate with threaded bolt for connection of intake air accessories (hole pattern according to DIN 24155).

■ Impeller

High performance backward curved centrifugal impeller made of polymer (T120 and ex-proof version made from aluminium). Dynamically balanced according to DIN ISO 1940-1.

■ Motor

Totally enclosed speed controllable external rotor motor IP 54 (Ex-proof version in IP 44). Flange motor with self-ventilation (T120 version) in IP 54. Ball bearing mounted with moisture protection. Maintenance-free and interference-free.

■ Motor protection

Through built-in thermal contacts or built-in PTC thermistor, which must be connected to a full motor protection device. See type table for assignment.

■ Electrical connection

Without dismantling the casing, to external isolator (ex-proof version to terminal box) protected to IP 65.

■ Guard

Standard on the exhaust side according to DIN EN ISO 13857.

■ Speed control

All 1~ types are steplessly speed controllable in the range from 0 – 100 % through electronic speed switch or five-step controller. All 3~ types are steplessly speed controllable in the range from 0 – 100 % with a frequency inverter with integrated all-pole Sine filter (except ex-proof version) or

Horizontal discharge RD

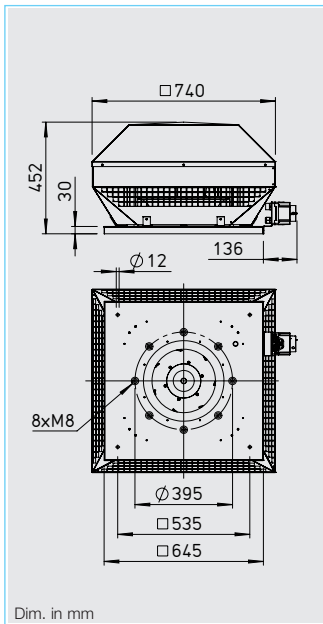

Dim. in mm

Vertical discharge VD

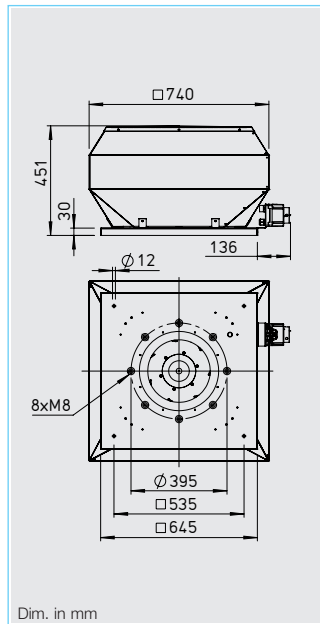

Dim. in mm

VD T120

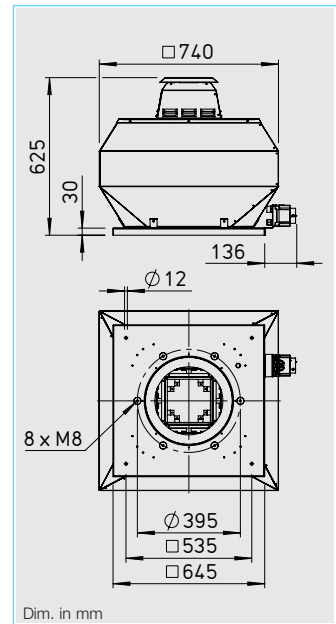

Dim. in mm

Accessories for Type RD / VD*

Counterflange FR 355 Ref. no. 1205

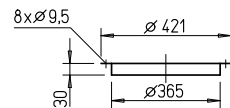

Flanged flexible connector STS 355 Ref. no. 1222

For ex-proof fans
STS 355 Ex Ref. no. 2504

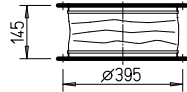

Automatic backdraught shutter RVS 355 Ref. no. 2595

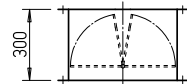

Motorised backdraught shutter RVM 355 Ref. no. 2579

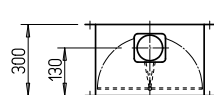

Hinged flat roof base FDS 355 Ref. no. 1380

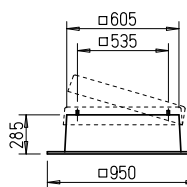

Corrugated roof base, profile 5 WDS 355 Ref. no. 1562

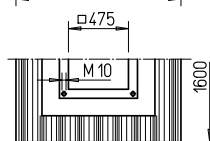
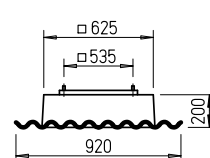

Hinged base attenuator SSD 355 Ref. no. 5024

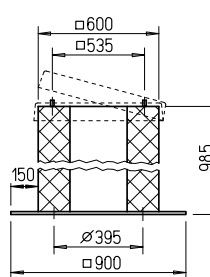

Roof fan attenuator HSDV 355 Ref. no. 7480
only for type VD

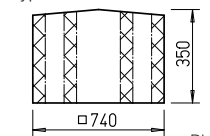

Dim. in mm

five-step controllers. See table for assignment.

■ Sound levels

The sum levels and spectrum figures are specified above the performance curve for:
– Sound level intake
– Sound level exhaust

The horizontal sound pressure level at 4 m (free field conditions) is also specified in the type table as well as the table below the performance curve.

■ Delivery

Ready-to-connect, completely pre-assembled in shipping carton.

Information	Page
Information for planning	10 on
Technical description	438
Selection chart	441
Accessories, details	485
Speed controller and switch	525 on

* Accessory VD T120 see installation accessories p. 485 Other accessories upon request.

RDW 355/4

Frequency	Hz	Total	125	250	500	1k	2k	4k
L _{WA} Intake		dB(A) 66	56	61	60	58	56	53
L _{WA} Exhaust		dB(A) 72	63	66	66	66	62	53

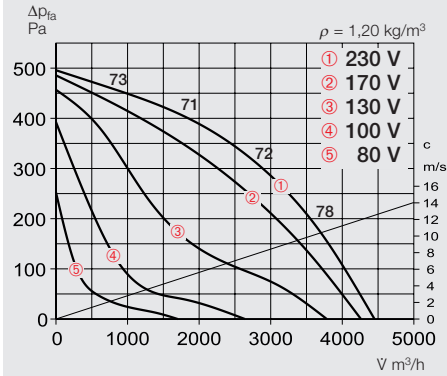

RDD 355/4

Frequency	Hz	Total	125	250	500	1k	2k	4k
L _{WA} Intake		dB(A) 66	56	61	60	58	56	53
L _{WA} Exhaust		dB(A) 72	63	66	66	66	62	53

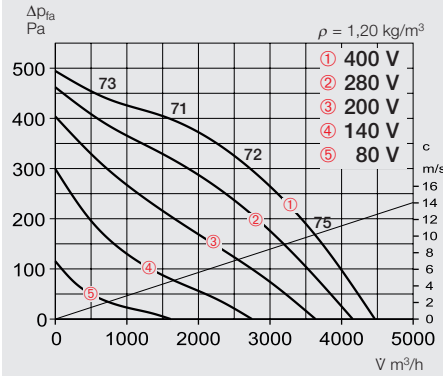

Type	Ref. no.	R.P.M.	Air flow volume (FID)	Sound pressure level	Motor power	Current full load	Current control	Wiring diagram	max. air flow temp. full load	Weight net	Full motor protection device	5-step speed switch
		min ⁻¹	m ³ /h	dB(A) in 4m	W	A	A	No.	°C	kg	Type Ref. no.	Type Ref. no.
Single phase motor 230 V, 50 Hz, capacitor motor, protection to IP 54												
RDW 355/4	7323	1400	4480	55	520	2.55	3.4	1128	70	55	MW 1579	MWS 5 ²⁾ 1949
Three phase motor 400 V, 50 Hz, squirrel-cage rotor, protection to IP 54												
RDD 355/4	7326	1350	4470	55	460	0.9	3.5	1129	60	60	MD 5849	RDS 7 ²⁾ 1578
Explosion-proof, three phase motor 400 V, 50 Hz, protection to IP 44, temp. class T1-T3												
RDD 355/4 Ex ¹⁾	7329	1360	3960	55	650	1.5	1.5	1129	40	40	MSA 1289	TSD 3 1502

1) Performance curve on www.HeliosSelect.de 2) includes full motor protection device

VDW 355/4

Frequency	Hz	Total	125	250	500	1k	2k	4k
L _{WA} Intake		dB(A) 66	56	61	60	58	56	53
L _{WA} Exhaust		dB(A) 71	61	65	65	65	62	53

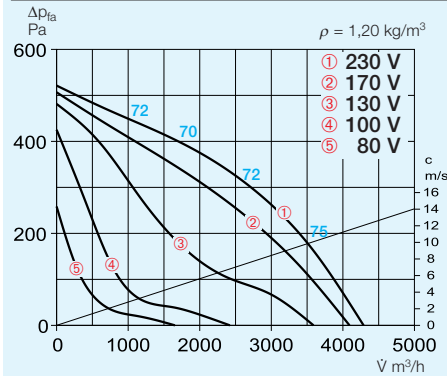

VDD 355/4

Frequency	Hz	Total	125	250	500	1k	2k	4k
L _{WA} Intake		dB(A) 66	56	61	60	58	56	53
L _{WA} Exhaust		dB(A) 71	61	64	64	64	60	52

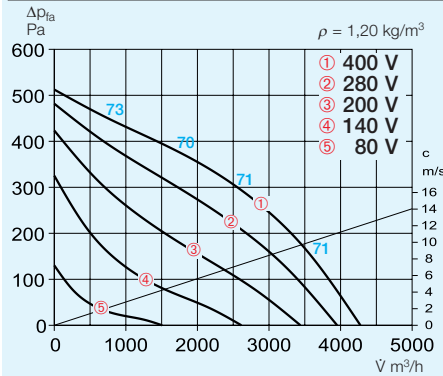

Type	Ref. no.	R.P.M.	Air flow volume (FID)	Sound pressure level	Motor power	Current full load	Current control	Wiring diagram	max. air flow temp. full load	Weight net	Full motor protection device	5-step speed switch
		min ⁻¹	m ³ /h	dB(A) in 4m	W	A	A	No.	°C	kg	Type Ref. no.	Type Ref. no.
Single phase motor 230 V, 50 Hz, capacitor motor, protection to IP 54												
VDW 355/4	7317	1400	4300	54	520	2.55	3.4	1128	70	55	MW 1579	MWS 5 ²⁾ 1949
Three phase motor 400 V, 50 Hz, squirrel-cage rotor, protection to IP 54												
VDD 355/4	7318	1350	4290	54	460	0.9	3.5	1129	60	60	MD 5849	RDS 7 ²⁾ 1578
Explosion-proof, three phase motor 400 V, 50 Hz, protection to IP 44, temp. class T1-T3												
VDD 355/4 Ex ¹⁾	7327	1360	3880	54	650	1.5	1.5	1129	40	40	MSA 1289	TSD 3 1502
Three phase motor 400 V, 50 Hz, squirrel-cage rotor, protection to IP 54												
VDD 355/4 T120 ¹⁾	7336	1420	4315	54	540	1.7	1.8	1129	120	100	MD 5849	RDS 4 ²⁾ 1316

1) Performance curve on www.HeliosSelect.de 2) includes full motor protection device

Series specification

■ Specification RD

Centrifugal roof fan with horizontal discharge and efficiency-optimised aluminium casing and newly developed high-performance centrifugal impeller.

■ Specification VD

Centrifugal roof fan with vertical discharge and efficiency-optimised aluminium casing and newly developed high-performance centrifugal impeller.

■ Special feature VD T120

Designed for moving process air up to +120 °C. Encapsulated motor located outside of air flow.

Specification for all series

■ Casing

Casing made from seawater-resistant aluminium with integrated protection. Motor base plate and base plate with inlet cone made from galvanised steel (inlet cone ex-proof version made from aluminium). Base plate with threaded bolt for connection of intake air accessories (hole pattern according to DIN 24155).

■ Impeller

High performance backward curved centrifugal impeller made of polymer (T120 and ex-proof version made from aluminium). Dynamically balanced according to DIN ISO 1940-1.

■ Motor

Totally enclosed speed controllable external rotor motor IP 54 (Ex-proof version in IP 44). Flange motor with self-ventilation (T120 version) in IP 54. Ball bearing mounted with moisture protection. Maintenance-free and interference-free.

■ Motor protection

Through built-in thermal contacts or built-in PTC thermistor, which must be connected to a full motor protection device. See type table for assignment.

■ Electrical connection

Without dismantling the casing, to external isolator (ex-proof version to terminal box) protected to IP 65.

■ Guard

Standard on the exhaust side according to DIN EN ISO 13857.

■ Speed control

All 1~ types are steplessly speed controllable in the range from 0 – 100 % through electronic speed switch or five-step controller. All 3~ types are steplessly speed controllable in the range from 0 – 100 % with a frequency inverter with integrated all-pole Sine filter (except ex-proof version) or

Horizontal discharge RD

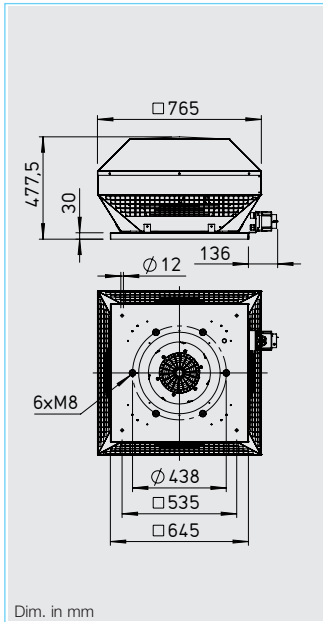

Dim. in mm

Vertical discharge VD

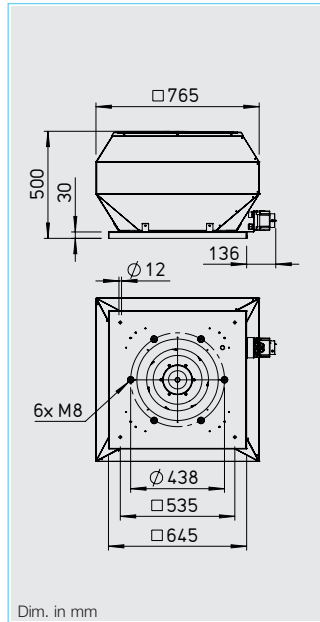

Dim. in mm

VD T120

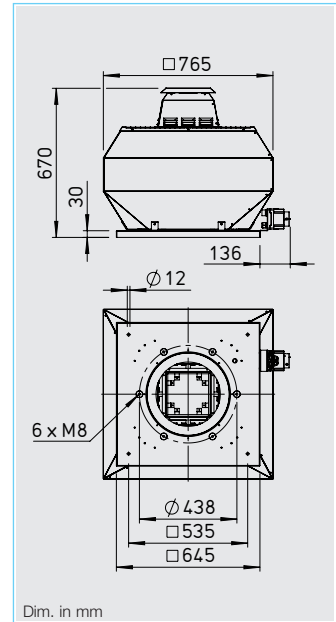

Dim. in mm

Accessories for Type RD / VD*

Counterflange FR 400 Ref. no. 1206

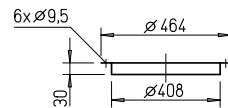

Flanged flexible connector STS 400 Ref. no. 1223

For ex-proof fans

STS 400 Ex Ref. no. 2505

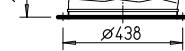

Automatic backdraught shutter RVS 400 Ref. no. 2596

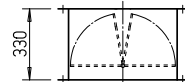

Motorised backdraught shutter RVM 400 Ref. no. 2580

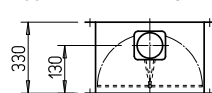

Hinged flat roof base FDS 400 Ref. no. 1380

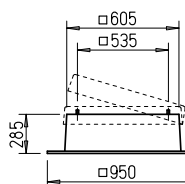

Corrugated roof base, profile 5 WDS 400 Ref. no. 1562

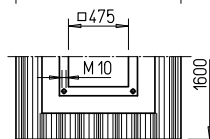
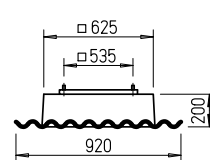

Hinged base attenuator SSD 400 Ref. no. 5291

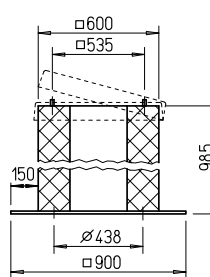

Roof fan attenuator HSDV 400 Ref. no. 7481

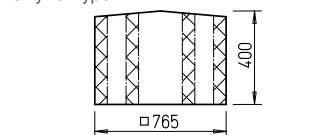

Dim. in mm

five-step controllers. See table for assignment.

■ Sound levels

The sum levels and spectrum figures are specified above the performance curve for:
– Sound level intake
– Sound level exhaust

The horizontal sound pressure level at 4 m (free field conditions) is also specified in the type table as well as the table below the performance curve.

■ Delivery

Ready-to-connect, completely pre-assembled in shipping carton.

Information	Page
Information for planning	10 on
Technical description	438
Selection chart	441
Accessories, details	485
Speed controller and switch	525 on

* Accessory VD T120 see installation accessories p. 485 Other accessories upon request.

RDW 400/4

Frequency	Hz	Total	125	250	500	1k	2k	4k
L _{WA} Intake		dB(A) 71	61	65	66	63	62	56
L _{WA} Exhaust		dB(A) 76	67	70	70	70	66	59

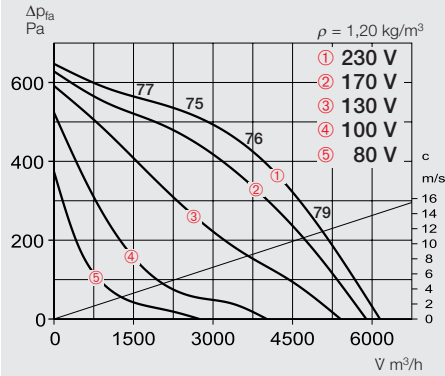

RDD 400/4

Frequency	Hz	Total	125	250	500	1k	2k	4k
L _{WA} Intake		dB(A) 70	60	64	65	62	61	55
L _{WA} Exhaust		dB(A) 75	66	69	69	69	65	58

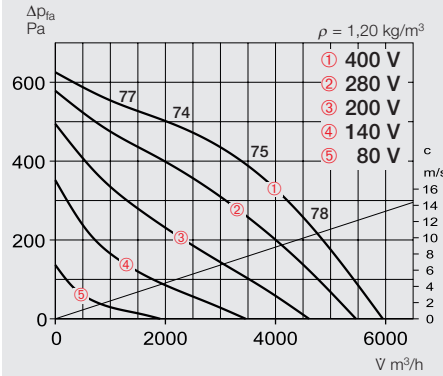

RDD 400/6

Frequency	Hz	Total	125	250	500	1k	2k	4k
L _{WA} Intake		dB(A) 61	51	55	56	53	52	46
L _{WA} Exhaust		dB(A) 66	57	60	60	60	56	49

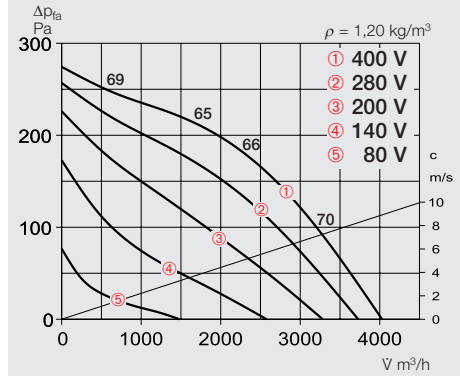

Type	Ref. no.	R.P.M.	Air flow volume (FID)	Sound pressure level	Motor power	Current full load	Current control	Wiring diagram	max. air flow temp. full load	Weight net	Full motor protection device	5-step speed switch
		min ⁻¹	m ³ /h	dB(A) in 4m	W	A	A	No.	°C	kg	Type Ref. no.	Type Ref. no.
Single phase motor 230 V, 50 Hz, capacitor motor, protection to IP 54												
RDW 400/4	7350	1405	6150	59	875	4.3	6.0	1128	60	40	MW 1579	MSW 7,5 ²⁾ 1950
Three phase motor 400 V, 50 Hz, squirrel-cage rotor, protection to IP 54												
RDD 400/6	7352	905	4030	49	260	0.6	0.6	1129	60	60	MD 5849	RDS 1 ²⁾ 1314
RDD 400/4	7351	1375	5970	58	765	1.55	1.6	1129	60	55	MD 5849	RDS 2 ²⁾ 1315
Explosion-proof, three phase motor 400 V, 50 Hz, protection to IP 44, temp. class T1-T3												
RDD 400/6 Ex ¹⁾	7363	935	4325	49	300	0.77	0.83	1129	40	40	MSA 1289	TSD 1,5 1501
RDD 400/4 Ex ¹⁾	7358	1375	5700	58	1000	2.1	2.2	1129	40	40	MSA 1289	TSD 1,5 1501

1) Performance curve on www.HeliosSelect.de 2) includes full motor protection device

VDW 400/4

Frequency	Hz	Total	125	250	500	1k	2k	4k
L _{WA} Intake		dB(A) 71	61	65	66	63	62	56
L _{WA} Exhaust		dB(A) 76	63	71	70	70	66	60

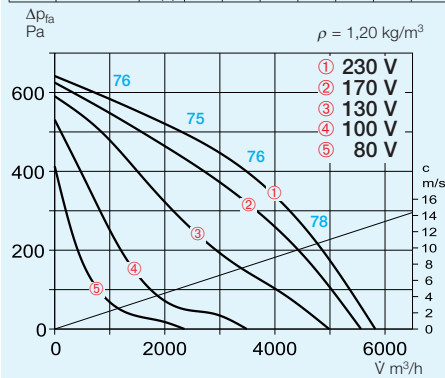

VDD 400/4

Frequency	Hz	Total	125	250	500	1k	2k	4k
L _{WA} Intake		dB(A) 69	59	63	64	61	60	54
L _{WA} Exhaust		dB(A) 74	61	69	68	68	64	58

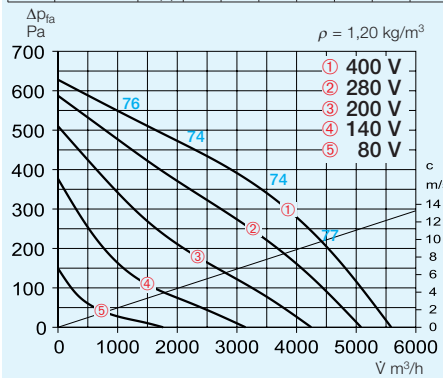

VDD 400/6

Frequency	Hz	Total	125	250	500	1k	2k	4k
L _{WA} Intake		dB(A) 61	51	55	56	53	52	46
L _{WA} Exhaust		dB(A) 66	53	61	60	60	56	50

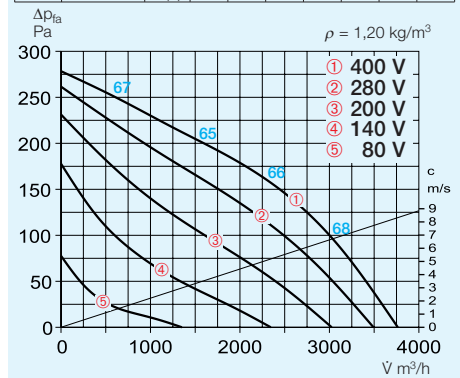

Type	Ref. no.	R.P.M.	Air flow volume (FID)	Sound pressure level	Motor power	Current full load	Current control	Wiring diagram	max. air flow temp. full load	Weight net	Full motor protection device	5-step speed switch
		min ⁻¹	m ³ /h	dB(A) in 4m	W	A	A	No.	°C	kg	Type Ref. no.	Type Ref. no.
Single phase motor 230 V, 50 Hz, capacitor motor, protection to IP 54												
VDW 400/4	7338	1405	5830	59	875	4.3	6.0	1128	60	40	MW 1579	MWS 7,5 ²⁾ 1950
Three phase motor 400 V, 50 Hz, squirrel-cage rotor, protection to IP 54												
VDD 400/6	7343	905	3780	49	260	0.6	0.6	1129	60	60	MD 5849	RDS 1 ²⁾ 1314
VDD 400/4	7342	1375	5590	57	765	1.55	1.6	1129	60	55	MD 5849	RDS 2 ²⁾ 1315
Explosion-proof, three phase motor 400 V, 50 Hz, protection to IP 44, temp. class T1-T3												
VDD 400/6 Ex ¹⁾	7359	935	3865	49	300	0.77	0.83	1129	40	40	MSA 1289	TSD 1,5 1501
VDD 400/4 Ex ¹⁾	7353	1375	5350	57	1000	2.1	2.2	1129	40	40	MSA 1289	TSD 3 1502
Three phase motor 400 V, 50 Hz, squirrel-cage rotor, protection to IP 54												
VDD 400/6 T120 ¹⁾	7366	930	4170	49	360	1.0	1.0	1129	120	100	MD 5849	RDS 2 ²⁾ 1315
VDD 400/4 T120 ¹⁾	7370	1350	6050	57	880	1.8	1.8	1129	120	100	MD 5849	RDS 4 ²⁾ 1316

1) Performance curve on www.HeliosSelect.de 2) includes full motor protection device

Series specification

■ Specification RD

Centrifugal roof fan with horizontal discharge and efficiency-optimised aluminium casing and newly developed high-performance centrifugal impeller.

■ Specification VD

Centrifugal roof fan with vertical discharge and efficiency-optimised aluminium casing and newly developed high-performance centrifugal impeller.

■ Special feature VD T120

Designed for moving process air up to +120 °C. Encapsulated motor located outside of air flow.

Specification for all series

■ Casing

Casing made from seawater-resistant aluminium with integrated protection. Motor base plate and base plate with inlet cone made from galvanised steel (inlet cone ex-proof version made from aluminium). Base plate with threaded bolt for connection of intake air accessories (hole pattern according to DIN 24155).

■ Impeller

High performance backward curved centrifugal impeller made of polymer (T120 and ex-proof version made from aluminium). Dynamically balanced according to DIN ISO 1940-1.

■ Motor

Totally enclosed speed controllable external rotor motor IP 54 (Ex-proof version in IP 44). Flange motor with self-ventilation (T120 version) in IP 54. Ball bearing mounted with moisture protection. Maintenance-free and interference-free.

■ Motor protection

Through built-in thermal contacts or built-in PTC thermistor, which must be connected to a full motor protection device. See type table for assignment.

■ Electrical connection

Without dismantling the casing, to external isolator (ex-proof version to terminal box) protected to IP 65.

■ Guard

Standard on the exhaust side according to DIN EN ISO 13857.

■ Speed control

All 1~ types are steplessly speed controllable in the range from 0 – 100 % through electronic speed switch or five-step controller. All 3~ types are steplessly speed controllable in the range from 0 – 100 % with a frequency inverter with integrated all-pole Sine filter (except ex-proof version) or

Horizontal discharge RD

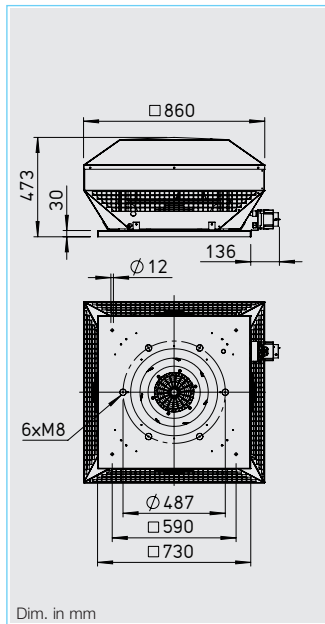

Dim. in mm

Vertical discharge VD

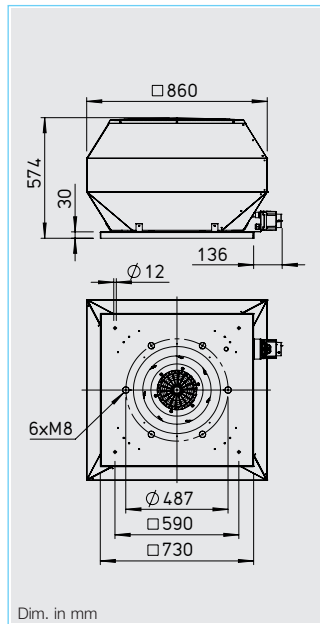

Dim. in mm

VD T120

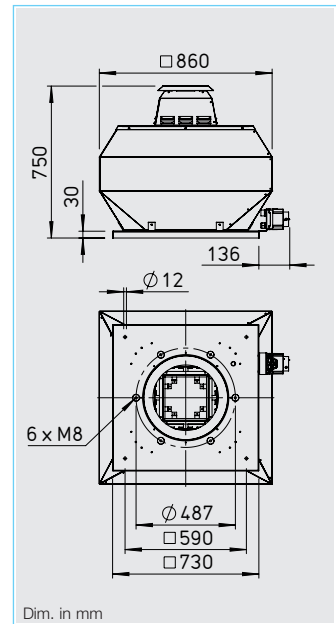

Dim. in mm

Accessories for Type RD / VD*

Counterflange FR 450

Ref. no. 1207

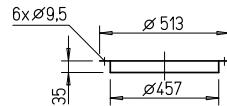

Flanged flexible connector STS 450

Ref. no. 1224

For ex-proof fans STS 450 Ex

Ref. no. 2506

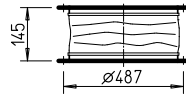

Automatic backdraught shutter RVS 450

Ref. no. 2597

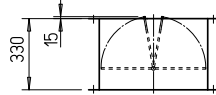

Motorised backdraught shutter RVM 450

Ref. no. 2581

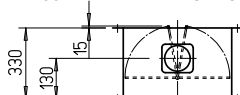

Hinged flat roof base FDS 450

Ref. no. 1381

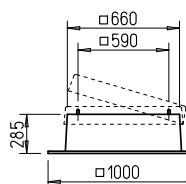

Corrugated roof base, profile 5 WDS 450

Ref. no. 1563

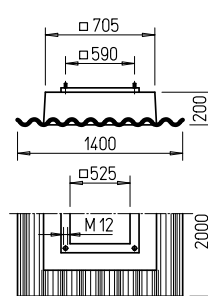

Hinged base attenuator SSD 450

Ref. no. 5288

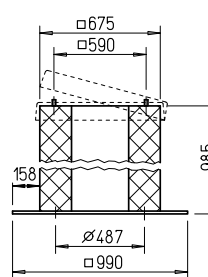

Roof fan attenuator HSDV 450

Ref. no. 7482

only for type VD

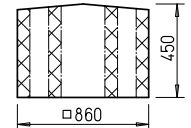

Dim. in mm

five-step controllers. See table for assignment.

■ Sound levels

The sum levels and spectrum figures are specified above the performance curve for:
– Sound level intake
– Sound level exhaust

The horizontal sound pressure level at 4 m (free field conditions) is also specified in the type table as well as the table below the performance curve.

■ Delivery

Ready-to-connect, completely pre-assembled in shipping carton. Simple positioning with stand crane hooks.

Information	Page
Information for planning	10 on
Technical description	438
Selection chart	441
Accessories, details	485
Speed controller and switch	525 on

* Accessory VD T120 see installation accessories p. 485 Other accessories upon request.

RDW 450/4

Frequency	Hz	Total	125	250	500	1k	2k	4k	
L _{WA} Intake		dB(A)	74	63	68	68	67	66	61
L _{WA} Exhaust		dB(A)	79	69	70	70	74	69	62

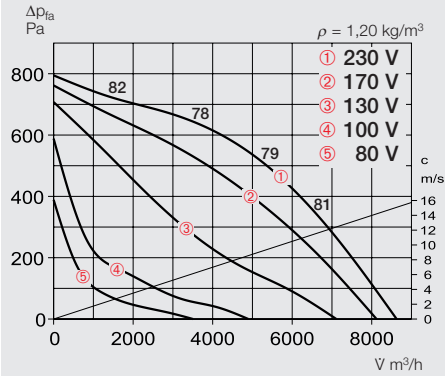

RDD 450/4

Frequency	Hz	Total	125	250	500	1k	2k	4k	
L _{WA} Intake		dB(A)	74	63	68	68	67	66	61
L _{WA} Exhaust		dB(A)	79	69	70	70	74	69	62

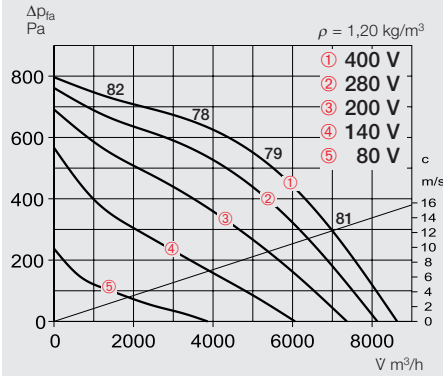

RDD 450/6

Frequency	Hz	Total	125	250	500	1k	2k	4k	
L _{WA} Intake		dB(A)	65	54	59	59	58	57	52
L _{WA} Exhaust		dB(A)	70	60	61	61	65	60	53

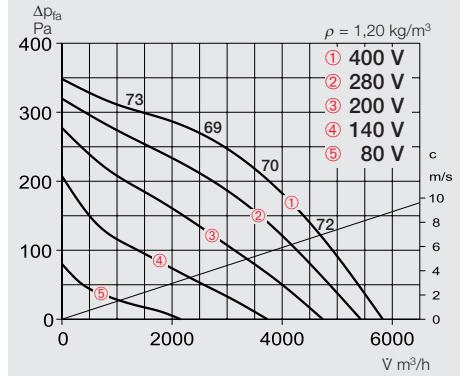

Type	Ref. no.	R.P.M.	Air flow volume (FID)	Sound pressure level	Motor power	Current full load	Current control	Wiring diagram	max. air flow temp. full load	Weight net	Full motor protection device	5-step speed switch
		min ⁻¹	m ³ /h	dB(A) in 4m	W	A	A	No.	°C	kg	Type Ref. no.	Type Ref. no.
Single phase motor 230 V, 50 Hz, capacitor motor, protection to IP 54												
RDW 450/4	7377	1385	8650	62	1470	6.6	8.7	1128	60	40	MW 1579	MWS 10 ²⁾ 1946
Three phase motor 400 V, 50 Hz, squirrel-cage rotor, protection to IP 54												
RDD 450/6	7385	905	5850	53	425	1.1	1.1	1129	60	60	MD 5849	RDS 2 ²⁾ 1315
RDD 450/4	7384	1400	8650	62	1350	2.6	2.9	1129	70	70	MD 5849	RDS 7 ²⁾ 1316
Explosion-proof, three phase motor 400 V, 50 Hz, protection to IP 44, temp. class T1-T3												
RDD 450/6 Ex ¹⁾	7391	860	5850	53	520	0.95	0.95	1129	40	40	MSA 1289	TSD 1,5 1501
RDD 450/4 Ex ¹⁾	7390	1400	8780	62	1550	3.8	3.8	1129	40	40	MSA 1289	TSD 5,5 1503

1) Performance curve on www.HeliosSelect.de 2) includes full motor protection device

VDW 450/4

Frequency	Hz	Total	125	250	500	1k	2k	4k
L _{WA} Intake		dB(A)	73	62	67	66	65	60
L _{WA} Exhaust		dB(A)	79	69	70	70	74	69

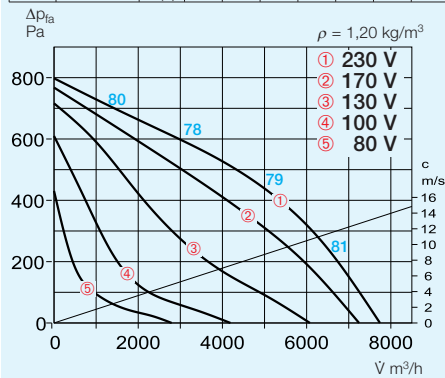

VDD 450/4

Frequency	Hz	Total	125	250	500	1k	2k	4k
L _{WA} Intake		dB(A)	73	62	67	66	65	60
L _{WA} Exhaust		dB(A)	79	70	71	71	75	63

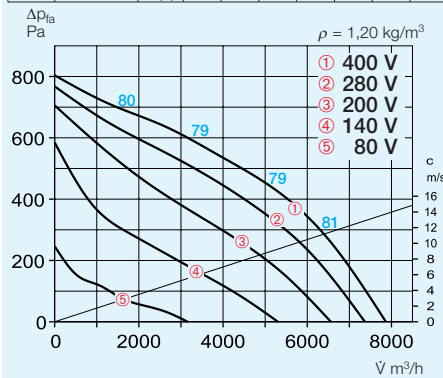

VDD 450/6

Frequency	Hz	Total	125	250	500	1k	2k	4k
L _{WA} Intake		dB(A)	64	53	58	58	57	56
L _{WA} Exhaust		dB(A)	70	60	61	61	65	60

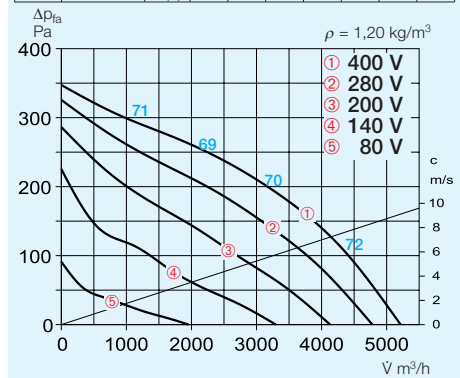

Type	Ref. no.	R.P.M.	Air flow volume (FID)	Sound pressure level	Motor power	Current full load	Current control	Wiring diagram	max. air flow temp. full load	Weight net	Full motor protection device	5-step speed switch
		min ⁻¹	m ³ /h	dB(A) in 4m	W	A	A	No.	°C	kg	Type Ref. no.	Type Ref. no.
Single phase motor 230 V, 50 Hz, capacitor motor, protection to IP 54												
VDW 450/4	7372	1385	7750	62	1470	6.6	8.7	1128	60	40	MW 1579	MWS 10 ²⁾ 1946
Three phase motor 400 V, 50 Hz, squirrel-cage rotor, protection to IP 54												
VDD 450/6	7380	905	5200	53	425	1.1	1.1	1129	60	60	MD 5849	RDS 2 ²⁾ 1315
VDD 450/4	7379	1400	7900	62	1350	2.6	2.9	1129	70	70	MD 5849	RDS 7 ²⁾ 1316
Explosion-proof, three phase motor 400 V, 50 Hz, protection to IP 44, temp. class T1-T3												
VDD 450/6 Ex ¹⁾	7387	860	5230	53	520	0.95	0.95	1129	40	40	MSA 1289	TSD 1,5 1501
VDD 450/4 Ex ¹⁾	7386	1400	7700	62	1550	3.8	3.8	1129	40	40	MSA 1289	TSD 5,5 1503
Three phase motor 400 V, 50 Hz, squirrel-cage rotor, protection to IP 54												
VDD 450/6 T120 ¹⁾	7399	900	5570	53	490	1.4	1.4	1129	120	100	MD 5849	RDS 2 ²⁾ 1315
VDD 450/4 T120 ¹⁾	7398	1390	8600	62	1330	3.8	3.8	1129	120	100	MD 5849	RDS 7 ²⁾ 1578

1) Performance curve on www.HeliosSelect.de 2) includes full motor protection device

Series specification

■ Specification RD

Centrifugal roof fan with horizontal discharge and efficiency-optimised aluminium casing and newly developed high-performance centrifugal impeller.

■ Specification VD

Centrifugal roof fan with vertical discharge and efficiency-optimised aluminium casing and newly developed high-performance centrifugal impeller.

■ Special feature VD T120

Designed for moving process air up to +120 °C. Encapsulated motor located outside of air flow.

Specification for all series

■ Casing

Casing made from seawater-resistant aluminium with integrated protection. Motor base plate and base plate with inlet cone made from galvanised steel (inlet cone ex-proof version made from aluminium). Base plate with threaded bolt for connection of intake air accessories (hole pattern according to DIN 24155).

■ Impeller

High performance backward curved centrifugal impeller made of polymer (T120 and ex-proof version made from aluminium). Dynamically balanced according to DIN ISO 1940-1.

■ Motor

Totally enclosed speed controllable external rotor motor IP 54 (Ex-proof version in IP 44). Flange motor with self-ventilation (T120 version) in IP 54/55. Ball bearing mounted with moisture protection. Maintenance-free and interference-free.

■ Motor protection

Through built-in thermal contacts or built-in PTC thermistor, which must be connected to a full motor protection device. See type table for assignment.

■ Electrical connection

Without dismantling the casing, to external isolator (ex-proof version to terminal box) protected to IP 65.

■ Guard

Standard on the exhaust side according to DIN EN ISO 13857.

■ Speed control

All types are steplessly speed controllable in the range from 0 – 100 % with a frequency inverter with an integrated, all-pole sine filter (except ex-proof version) or five-step controllers (except devices with FU). See table for assignment.

Horizontal discharge RD

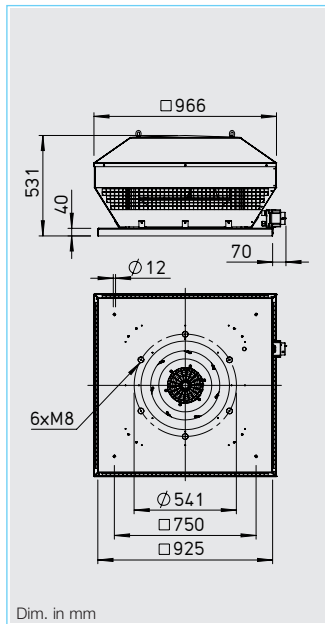

Vertical discharge VD

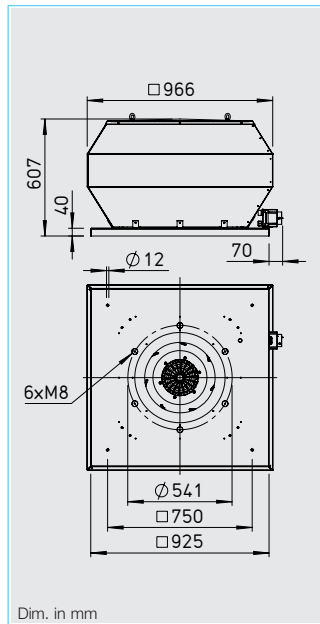

VD T120

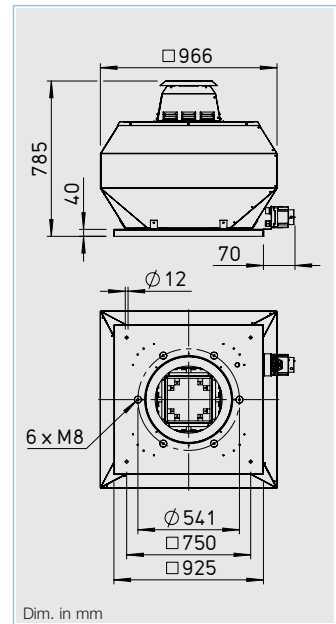

Accessories for Type RD / VD*

Counterflange FR 500

Ref. no. 1208

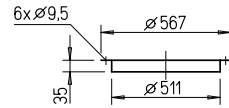

Corrugated roof base, profile 5 WDS 500

Ref. no. 1564

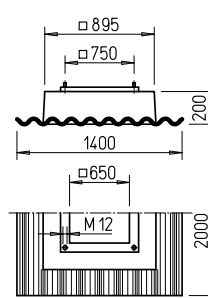

Flanged flexible connector STS 500

Ref. no. 1225

For ex-proof fans

STS 500 Ex

Ref. no. 2507

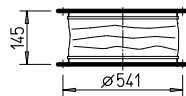

Automatic backdraught shutter RVS 500

Ref. no. 2598

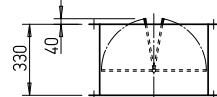

Motorised backdraught shutter RVM 500

Ref. no. 2582

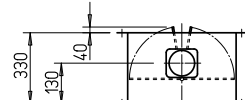

Flat roof base FDS 500

Ref. no. 1382

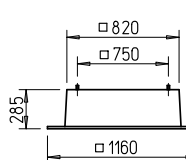

Roof fan attenuator HSDV 500

Ref. no. 7483

only for type VD

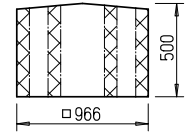

Dim. in mm

■ Sound levels

The sum levels and spectrum figures are specified above the performance curve for:
 – Sound level intake
 – Sound level exhaust

The horizontal sound pressure level at 4 m (free field conditions) is also specified in the type table as well as the table below the performance curve.

■ Delivery

Ready-to-connect, completely pre-assembled in shipping carton. Simple positioning with stand crane hooks.

Information	Page
Information for planning	10 on
Technical description	438
Selection chart	441
Accessories, details	485
Speed controller and switch	525 on

* Accessory VD T120 see installation accessories p. 485 Other accessories upon request.

RDD 500/4

Frequency	Hz	Total	125	250	500	1k	2k	4k
L _{WA} Intake		dB(A) 76	67	71	69	69	66	62
L _{WA} Exhaust		dB(A) 81	72	74	75	76	70	65

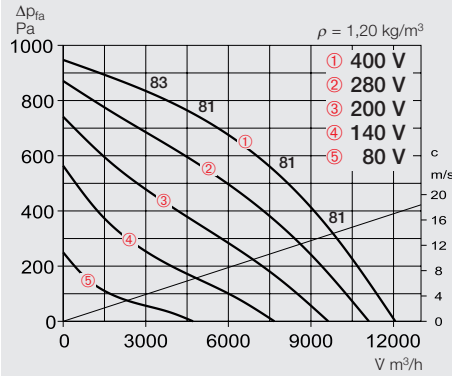

RDD 500/6

Frequency	Hz	Total	125	250	500	1k	2k	4k
L _{WA} Intake		dB(A) 67	58	62	60	60	57	53
L _{WA} Exhaust		dB(A) 72	63	65	66	67	61	56

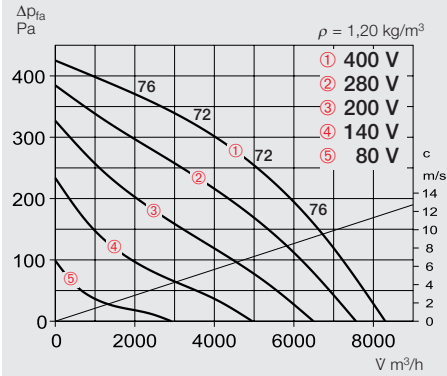

Type	Ref. no.	R.P.M.	Air flow volume (FID)	Sound pressure level	Motor power	Current full load	Current control	Wiring diagram	max. air flow full load	flow temp. control	Weight net	Full motor protection device	5-step speed switch		
		min ⁻¹	m ³ /h	dB(A) in 4m	W	A	A	No.	°C	°C	kg	Type	Ref. no.	Type	Ref. no.
Three phase motor 400 V, 50 Hz, squirrel-cage rotor, protection to IP 54															
RDD 500/6	7410	885	8300	55	680	1.55	1.55	1129	50	50	49.0	MD	5849	RDS 2 ²⁾	1315
RDD 500/4	7409	1340	12100	64	2150	4.15	4.25	1129	55	50	58.0	MD	5849	RDS 7 ²⁾	1578
Explosion-proof, three phase motor 400 V, 50 Hz, protection to IP 44, temp. class T1-T3															
RDD 500/6 Ex ¹⁾	7414	810	8050	55	560	1.1	1.1	1129	40	40	49.0	MSA	1289	TSD 1,5	1501
RDD 500/4 Ex ¹⁾	7416	1420	13030	64	2250	4.5	5.8	—	40	40	58.0	MSA	1289	TSD 7	1504

1) Performance curve on www.HeliosSelect.de 2) includes full motor protection device

VDD 500/4

Frequency	Hz	Total	125	250	500	1k	2k	4k
L _{WA} Intake		dB(A) 76	67	71	69	69	66	62
L _{WA} Exhaust		dB(A) 82	71	75	76	76	74	69

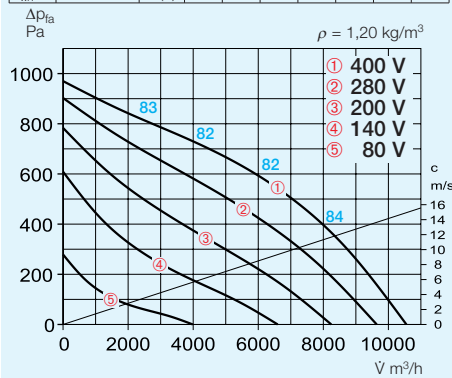

VDD 500/6

Frequency	Hz	Total	125	250	500	1k	2k	4k
L _{WA} Intake		dB(A) 67	58	62	60	60	57	53
L _{WA} Exhaust		dB(A) 73	62	66	67	67	65	60

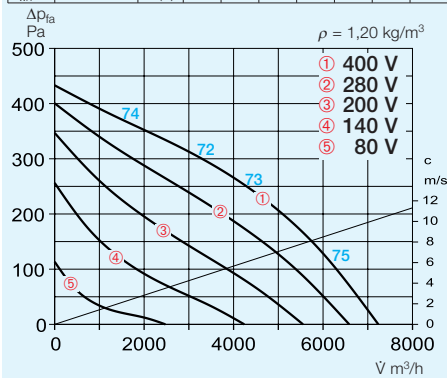

Type	Ref. no.	R.P.M.	Air flow volume (FID)	Sound pressure level	Motor power	Current full load	Current control	Wiring diagram	max. air flow full load	flow temp. control	Weight net	Full motor protection device	5-step speed switch / Frequency inverter		
		min ⁻¹	m ³ /h	dB(A) in 4m	W	A	A	No.	°C	°C	kg	Type	Ref. no.	Type	Ref. no.
Three phase motor 400 V, 50 Hz, squirrel-cage rotor, protection to IP 54															
VDD 500/6	7402	885	7250	56	680	1.55	1.55	1129	50	50	51.0	MD	5849	RDS 2 ²⁾	1315
VDD 500/4	7401	1340	10550	65	2150	4.15	4.25	1129	55	50	60.0	MD	5849	RDS 7 ²⁾	1578
Explosion-proof, three phase motor 400 V, 50 Hz, protection to IP 44, temp. class T1-T3															
VDD 500/6 Ex ¹⁾	7412	810	6900	56	560	1.1	1.1	1129	40	40	51.0	MSA	1289	TSD 1,5	1501
VDD 500/4 Ex ¹⁾	7413	1420	11400	65	2250	4.5	5.8	1129	40	40	60.0	MSA	1289	TSD 7	1504
Three phase motor 400 V, 50 Hz, squirrel-cage rotor, protection to IP 54 or IP 55*															
VDD 500/6 T120 ¹⁾	7419	910	8250	56	790	1.9	1.9	1129	120	100	62.0	MD	5849	RDS 4 ²⁾	1316
VDD 500/4 T120 ^{1)*}	7418	1440	13060	65	3000	6	—	1130	120	100	71.0	MSA	1289	FU-BS 14	5463

1) Performance curve on www.HeliosSelect.de 2) includes full motor protection device

Series specification

■ Specification RD

Centrifugal roof fan with horizontal discharge and efficiency-optimised aluminium casing and newly developed high-performance centrifugal impeller.

■ Specification VD

Centrifugal roof fan with vertical discharge and efficiency-optimised aluminium casing and newly developed high-performance centrifugal impeller.

■ Special feature VD T120

Designed for moving process air up to +120 °C. Encapsulated motor located outside of air flow.

Specification for all series

■ Casing

Casing made from seawater-resistant aluminium with integrated protection. Motor base plate and base plate with inlet cone made from galvanised steel (inlet cone ex-proof version made from aluminium). Base plate with threaded bolt for connection of intake air accessories (hole pattern according to DIN 24155).

■ Impeller

High performance backward curved centrifugal impeller made of aluminium. Dynamically balanced according to DIN ISO 1940-1.

■ Motor

Totally enclosed speed controllable external rotor motor IP 54 (Ex-proof version in IP 44).

Flange motor with self-ventilation (T120 version) in IP 54/55. Ball bearing mounted with moisture protection. Maintenance-free and interference-free.

■ Motor protection

Through built-in thermal contacts or built-in PTC thermistor, which must be connected to a full motor protection device. See type table for assignment.

■ Electrical connection

Without dismantling the casing, to external isolator (ex-proof version to terminal box) protected to IP 65.

■ Guard

Standard on the exhaust side according to DIN EN ISO 13857.

■ Speed control

All types are steplessly speed controllable in the range from 0 – 100 % with a frequency inverter with an integrated, all-pole sine filter (except ex-proof version) or five-step controllers (except devices with FU). See table for assignment.

Horizontal discharge RD

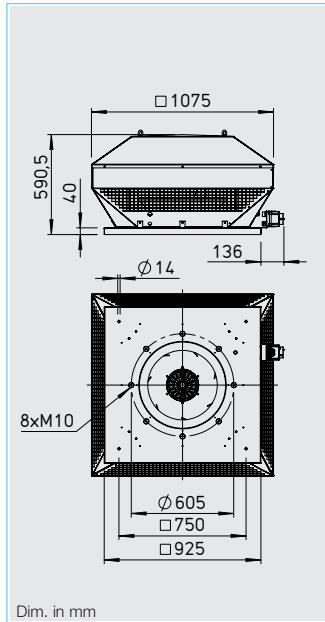

Dim. in mm

Vertical discharge VD

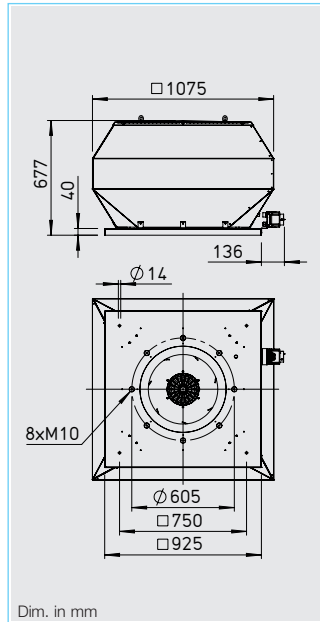

Dim. in mm

VD T120

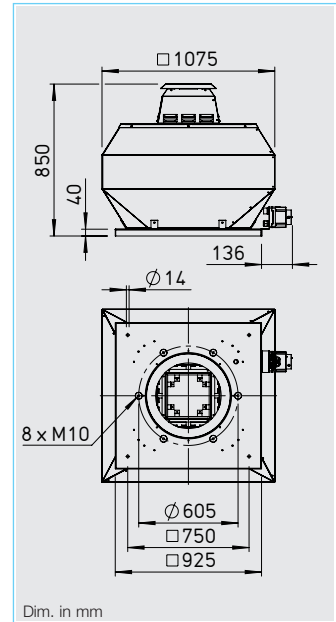

Dim. in mm

Accessories for Type RD / VD*

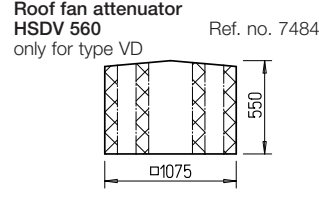
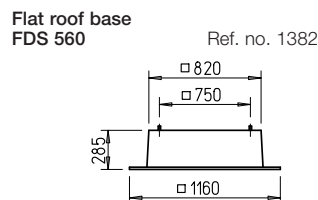
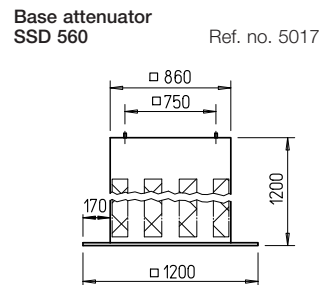
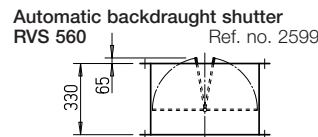
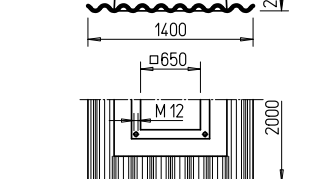
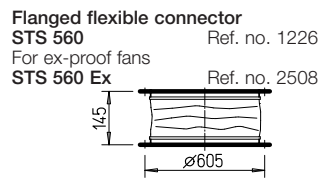
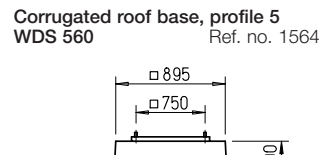
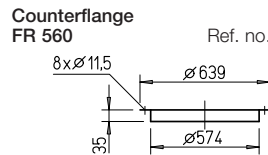

Dim. in mm

■ Sound levels

The sum levels and spectrum figures are specified above the performance curve for:

- Sound level intake
- Sound level exhaust

The horizontal sound pressure level at 4 m (free field conditions) is also specified in the type table as well as the table below the performance curve.

■ Delivery

Ready-to-connect, completely pre-assembled in shipping carton. Simple positioning with stand crane hooks.

Information	Page
Information for planning	10 on
Technical description	438
Selection chart	441
Accessories, details	485
Speed controller and switch	525 on

* Accessory VD T120 see installation accessories p. 485 Other accessories upon request.

RDD 560/4

Frequency	Hz	Total	125	250	500	1k	2k	4k
L _{WA} Intake		dB(A) 81	70	72	73	74	73	69
L _{WA} Exhaust		dB(A) 86	74	77	79	80	77	70

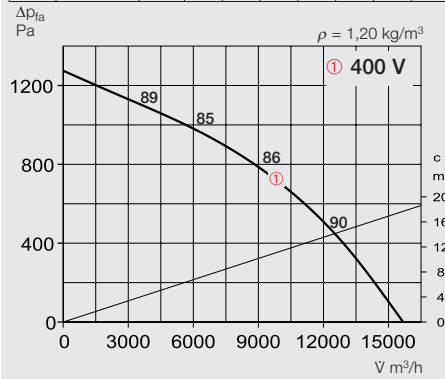

RDD 560/6

Frequency	Hz	Total	125	250	500	1k	2k	4k
L _{WA} Intake		dB(A) 72	62	64	65	66	65	61
L _{WA} Exhaust		dB(A) 77	66	69	71	72	69	62

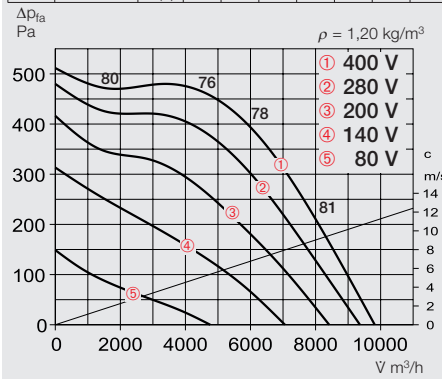

Type	Ref. no.	R.P.M.	Air flow volume (FID)	Sound pressure level	Motor power	Current full load	Current control	Wiring diagram	max. air flow temp. full load	Weight net	Full motor protection device	5-step speed switch / Frequency inverter
		min ⁻¹	m ³ /h	dB(A) in 4m	W	A	A	No.	°C	kg	Type Ref. no.	Type Ref. no.
Three phase motor 400 V, 50 Hz, squirrel-cage rotor, protection to IP 54												
RDD 560/6	7429	920	9850	60	1180	3.2	3.2	1130	65	73.0	MD 5849	RDS 7 ²⁾ 1578
RDD 560/4	7426	1385	15700	69	4430	6.4	—	1130	55	83.0	MD 5849	FU-BS 8,0 5461
Explosion-proof, three phase motor 400 V, 50 Hz, protection to IP 44, temp. class T1-T3												
RDD 560/6 Ex ¹⁾	7432	850	10620	60	1050	2.0	2.0	1129	40	73.0	MSA 1289	TSD 3 1502

1) Performance curve on www.HeliosSelect.de 2) includes full motor protection device

VDD 560/4

Frequency	Hz	Total	125	250	500	1k	2k	4k
L _{WA} Intake		dB(A) 82	71	73	74	75	74	70
L _{WA} Exhaust		dB(A) 86	75	79	81	80	76	72

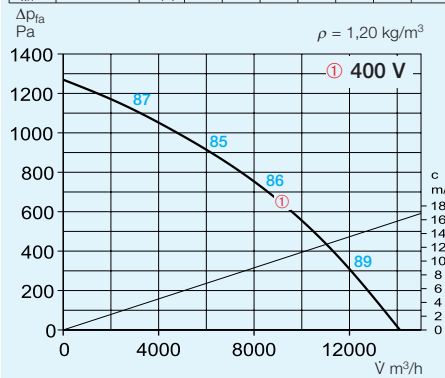

VDD 560/6

Frequency	Hz	Total	125	250	500	1k	2k	4k
L _{WA} Intake		dB(A) 72	61	63	64	65	64	60
L _{WA} Exhaust		dB(A) 77	66	70	72	71	67	63

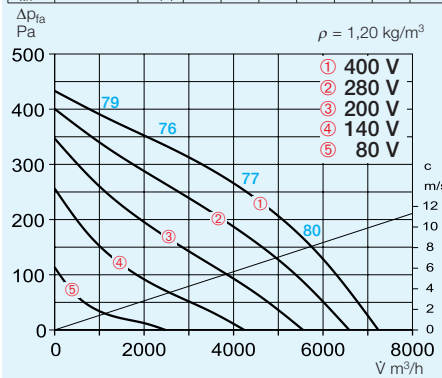

Type	Ref. no.	R.P.M.	Air flow volume (FID)	Sound pressure level	Motor power	Current full load	Current control	Wiring diagram	max. air flow temp. full load	Weight net	Full motor protection device	5-step speed switch / Frequency inverter
		min ⁻¹	m ³ /h	dB(A) in 4m	W	A	A	No.	°C	kg	Type Ref. no.	Type Ref. no.
Three phase motor 400 V, 50 Hz, squirrel-cage rotor, protection to IP 54												
VDD 560/6	7422	920	9250	60	1180	3.2	3.2	1130	65	77.0	MD 5849	RDS 7 ²⁾ 1578
VDD 560/4	7420	1385	14100	69	4430	6.4	—	1130	55	77.0	MD 5849	FU-BS 8,0 5461
Explosion-proof, three phase motor 400 V, 50 Hz, protection to IP 44, temp. class T1-T3												
VDD 560/6 Ex ¹⁾	7430	850	10000	60	1050	2.0	2.0	1129	40	92.0	MSA 1289	TSD 3 1502
Three phase motor 400 V, 50 Hz, squirrel-cage rotor, protection to IP 54 or IP 55*												
VDD 560/6 T120 ¹⁾	7439	930	12000	60	1300	3.5	3.5	1129	120	92.0	MD 5849	RDS 7 ²⁾ 1578
VDD 560/4 T120 ¹⁾	7436	1460	18830	69	5500	11.5	—	1130	120	102.0	MSA 1289	FU-BS 8,0 5461

1) Performance curve on www.HeliosSelect.de 2) includes full motor protection device

Series specification

■ Specification RD

Centrifugal roof fan with horizontal discharge and efficiency-optimised aluminium casing and newly developed high-performance centrifugal impeller.

■ Specification VD

Centrifugal roof fan with vertical discharge and efficiency-optimised aluminium casing and newly developed high-performance centrifugal impeller.

■ Special feature VD T120

Designed for moving process air up to +120 °C. Encapsulated motor located outside of air flow.

Specification for all series

■ Casing

Casing made from seawater-resistant aluminium with integrated protection. Motor base plate and base plate with inlet cone made from galvanised steel (inlet cone ex-proof version made from aluminium). Base plate with threaded bolt for connection of intake air accessories (hole pattern according to DIN 24155).

■ Impeller

High performance backward curved centrifugal impeller made of aluminium. Dynamically balanced according to DIN ISO 1940-1.

■ Motor

Totally enclosed speed controllable external rotor motor IP 54 (Ex-proof version in IP 44). Flange motor with self-ventilation (T120 version) in IP 55. Ball bearing mounted with moisture protection. Maintenance-free and interference-free.

■ Motor protection

Through built-in thermal contacts or built-in PTC thermistor, which must be connected to a full motor protection device. See type table for assignment.

■ Electrical connection

Without dismantling the casing, to external isolator (ex-proof version to terminal box) protected to IP 65.

■ Guard

Standard on the exhaust side according to DIN EN ISO 13857.

■ Speed control

All types are steplessly speed controllable in the range from 0 – 100 % with a frequency inverter with an integrated, all-pole sine filter (except ex-proof version) or five-step controllers (except devices with FU). See table for assignment.

Horizontal discharge RD

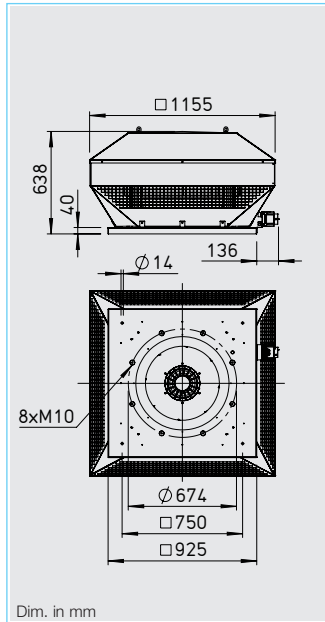

Dim. in mm

Vertical discharge VD

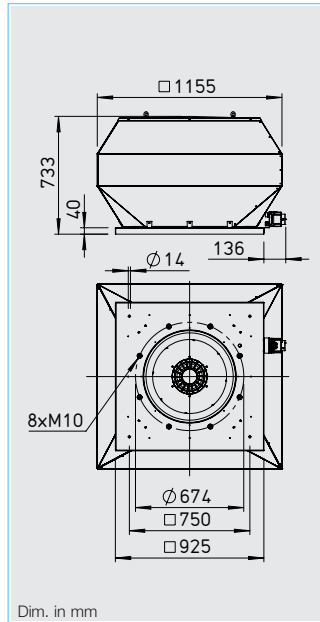

Dim. in mm

VD T120

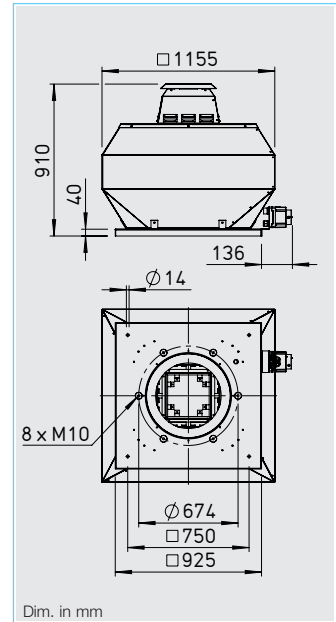

Dim. in mm

Accessories for Type RD / VD*

Counterflange FR 630 Ref. no. 1211

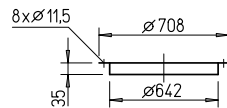

Flanged flexible connector STS 630 Ref. no. 1228

For ex-proof fans **STS 630 Ex** Ref. no. 2509

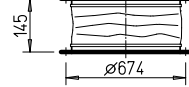

Automatic backdraught shutter RVS 630 Ref. no. 2600

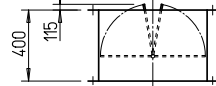

Motorised backdraught shutter RVM 630 Ref. no. 2609

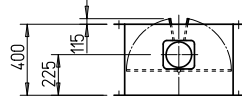

Flat roof base FDS 630 Ref. no. 1382

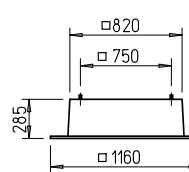

Corrugated roof base, profile 5 WDS 630 Ref. no. 1565

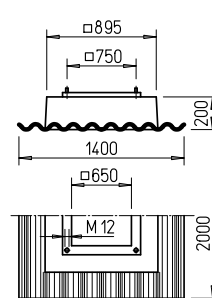

Base attenuator SSD 630 Ref. no. 5017

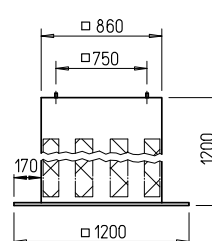

Roof fan attenuator HSDV 630 Ref. no. 7489

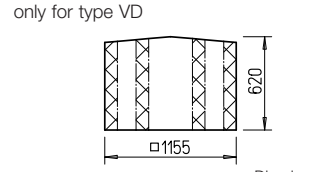

Dim. in mm

■ Sound levels

The sum levels and spectrum figures are specified above the performance curve for:
 – Sound level intake
 – Sound level exhaust

The horizontal sound pressure level at 4 m (free field conditions) is also specified in the type table as well as the table below the performance curve.

■ Delivery

Ready-to-connect, completely pre-assembled in shipping carton. Simple positioning with stand crane hooks.

Information	Page
Information for planning	10 on
Technical description	438
Selection chart	441
Accessories, details	485
Speed controller and switch	525 on

* Accessory VD T120 see installation accessories p. 485 Other accessories upon request.

RDD 630/6

Frequency	Hz	Total	125	250	500	1k	2k	4k
L _{WA} Intake		dB(A) 79	62	69	73	74	72	70
L _{WA} Exhaust		dB(A) 83	67	72	79	78	74	68

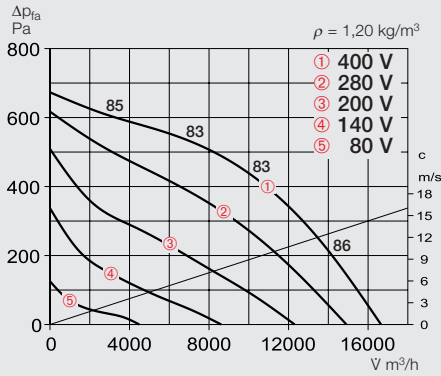

Type	Ref. no.	R.P.M.	Air flow volume (FID)	Sound pressure level	Motor power	Current full load	Current control	Wiring diagram	max. air flow temp. full load	Weight net	Full motor protection device	5-step speed switch
		min ⁻¹	m ³ /h	dB(A) in 4m	W	A	A	No.	°C	kg	Type Ref. no.	Type Ref. no.
Three phase motor 400 V, 50 Hz, squirrel-cage rotor, protection to IP 54												
RDD 630/6	7447	875	16650	66	2380	4.7	5.2	1129	55	45	MD 5849	RDS 7 ²⁾ 1578
Explosion-proof, three phase motor 400 V, 50 Hz, protection to IP 44, temp. class T1-T3												
RDD 630/6 Ex ¹⁾	7450	945	15660	66	2000	4.4	4.4	1129	40	40	MSA 1289	TSD 7 1504

1) Performance curve on www.HeliosSelect.de 2) includes full motor protection device

VDD 630/6

Frequency	Hz	Total	125	250	500	1k	2k	4k
L _{WA} Intake		dB(A) 78	61	68	72	73	71	69
L _{WA} Exhaust		dB(A) 83	67	72	79	78	74	68

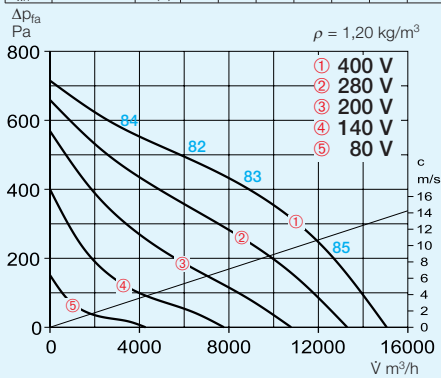

Type	Ref. no.	R.P.M.	Air flow volume (FID)	Sound pressure level	Motor power	Current full load	Current control	Wiring diagram	max. air flow temp. full load	Weight net	Full motor protection device	5-step speed switch / Frequency inverter
		min ⁻¹	m ³ /h	dB(A) in 4m	W	A	A	No.	°C	kg	Type Ref. no.	Type Ref. no.
Three phase motor 400 V, 50 Hz, squirrel-cage rotor, protection to IP 54												
VDD 630/6	7441	875	15050	66	2380	4.7	5.2	1129	55	45	90.0 MD 5849	RDS 7 ²⁾ 1578
Explosion-proof, three phase motor 400 V, 50 Hz, protection to IP 44, temp. class T1-T3												
VDD 630/6 Ex ¹⁾	7448	945	14100	66	2000	4.4	4.4	1129	40	40	90.0 MSA 1289	TSD 7 1504
Three phase motor 400 V, 50 Hz, squirrel-cage rotor, protection to IP 55												
VDD 630/6 T120 ¹⁾	7456	980	16600	66	4000	10	—	1130	120	100	105.0 MSA 1289	FU-BS 14 5463

1) Performance curve on www.HeliosSelect.de 2) includes full motor protection device



Series specification

■ Specification RD

Centrifugal roof fan with horizontal discharge and efficiency-optimised aluminium casing and newly developed high-performance centrifugal impeller.

■ Specification VD

Centrifugal roof fan with vertical discharge and efficiency-optimised aluminium casing and newly developed high-performance centrifugal impeller.

■ Special feature VD T120

Designed for moving process air up to +120 °C. Encapsulated motor located outside of air flow.

Specification for all series

■ Casing

Casing made from seawater-resistant aluminium with integrated protection. Motor base plate and base plate with inlet cone made from galvanised steel. Base plate with threaded bolt for connection of intake air accessories (hole pattern according to DIN 24155).

■ Impeller

High performance backward curved centrifugal impeller made of aluminium. Dynamically balanced according to DIN ISO 1940-1.

■ Motor

Totally enclosed speed controllable IEC standard motor with self-ventilation IP 55. Ball bearing mounted with moisture protection. Maintenance-free and interference-free.

■ Motor protection

Through built-in thermal contacts or built-in PTC thermistor, which must be connected to a full motor protection device. See type table for assignment.

■ Electrical connection

Without dismantling the casing, to external isolator protected to IP 65.

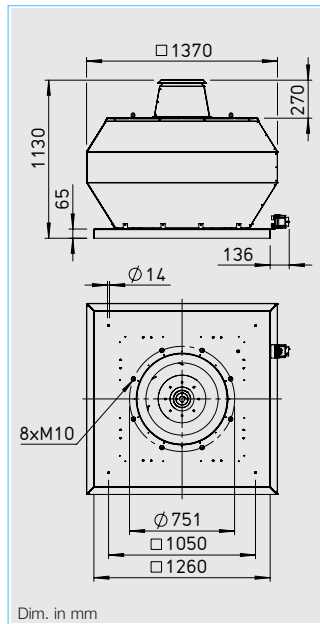
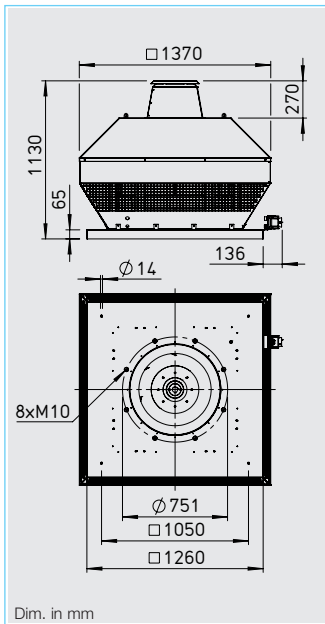

■ Guard

Standard on the exhaust side according to DIN EN ISO 13857.

■ Speed control

All types are steplessly speed controllable in the range from 0 – 100 % with a frequency inverter with an integrated, all-pole sine filter.

■ Sound levels

The sum levels and spectrum figures are specified above the performance curve for:
 – Sound level intake
 – Sound level exhaust

The horizontal sound pressure level at 4 m (free field conditions) is also specified in the type table as well as the table below the performance curve.

■ Delivery

Ready-to-connect, completely pre-assembled in shipping carton. Simple positioning with stand crane hooks.

Accessories for Type RD / VD*

Counterflange FR 710

Ref. no. 1212

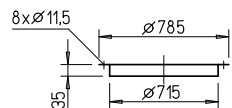

Base attenuator SSD 710

Ref. no. 5287

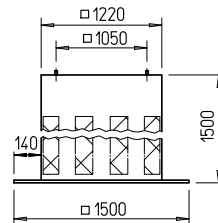

Flanged flexible connector STS 710

Ref. no. 1229

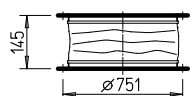

Automatic backdraught shutter RVS 710

Ref. no. 2601

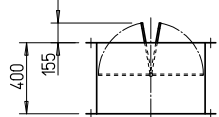

Motorised backdraught shutter RVM 710

Ref. no. 2610

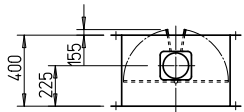

Flat roof base FDS 710

Ref. no. 6658

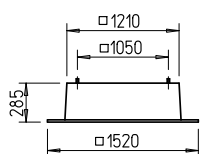

Dim. in mm

Information	Page
Information for planning	10 on
Technical description	438
Selection chart	441
Accessories, details	485
Speed controller and switch	525 on

* Accessory VD T120 see installation accessories p. 485 Other accessories upon request.

RDD 710/6

Frequency	Hz	Total	125	250	500	1k	2k	4k
L _{WA} Intake		dB(A) 79	68	71	71	72	74	68
L _{WA} Exhaust		dB(A) 83	71	73	76	77	78	70

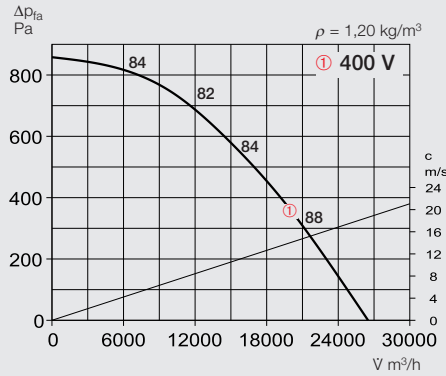

Type	Ref. no.	R.P.M.	Air flow volume (FID)	Sound pressure level	Motor power	Current full load	Current control	Wiring diagram	max. air flow full load	max. air flow temp. control	Weight net	Full motor protection device	5-step speed switch / Frequency inverter		
		min ⁻¹	m ³ /h	dB(A) in 4m	W	A	A	No.	°C	°C	kg	Type	Ref. no.	Type	Ref. no.
Three phase motor 400 V, 50 Hz, squirrel-cage rotor, protection to IP 54															
RDD 710/6	7460	905	26500	66	5500	12.2	—	1130	50	50	112.0	MSA	1289	FU-BS 14	5463

VDD 710/6

Frequency	Hz	Total	125	250	500	1k	2k	4k
L _{WA} Intake		dB(A) 78	67	70	70	71	73	67
L _{WA} Exhaust		dB(A) 83	71	73	76	77	78	70

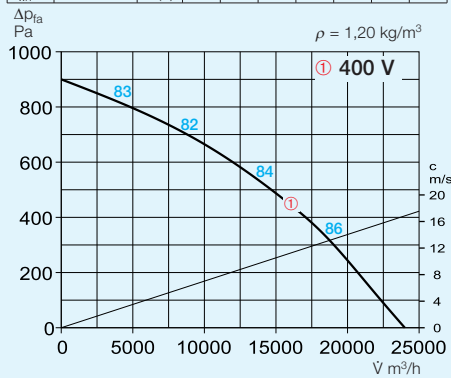

Type	Ref. no.	R.P.M.	Air flow volume (FID)	Sound pressure level	Motor power	Current full load	Current control	Wiring diagram	max. air flow full load	max. air flow temp. control	Weight net	Full motor protection device	5-step speed switch / Frequency inverter		
		min ⁻¹	m ³ /h	dB(A) in 4m	W	A	A	No.	°C	°C	kg	Type	Ref. no.	Type	Ref. no.
Three phase motor 400 V, 50 Hz, squirrel-cage rotor, protection to IP 54															
VDD 710/6	7458	905	24000	66	5500	12.2	—	1130	50	50	115.0	MSA	1289	FU-BS 14	5463
Three phase motor 400 V, 50 Hz, squirrel-cage rotor, protection to IP 55															
VDD 710/6 T120 ¹⁾	7466	965	24000	66	5500	12.2	—	1130	120	100	130.0	MSA	1289	FU-BS 14	5463

1) Performance curve on www.HeliosSelect.de

HDH

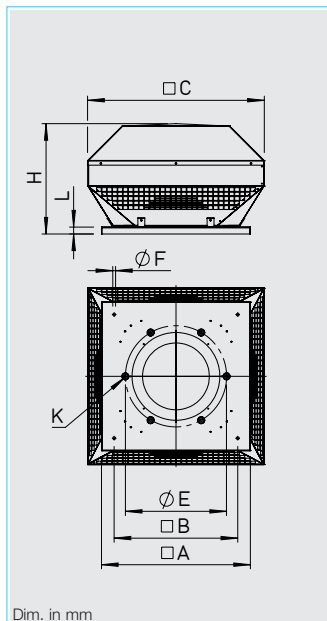

■ **Roof cowl HDH**

For covering the convection and supply air vents on the roof. Same design as horizontal discharge roof fans RD. When using in mechanical ventilation systems the emerging flow losses must be considered (see diagram). Accessories same as for roof fans.

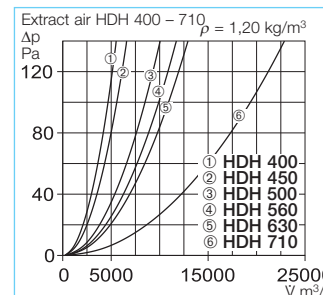
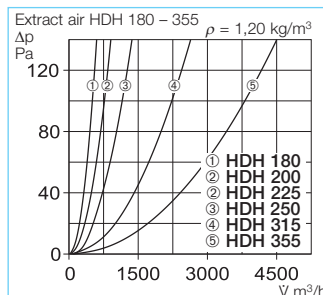
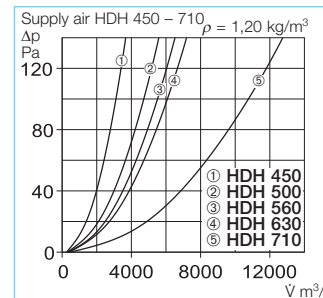
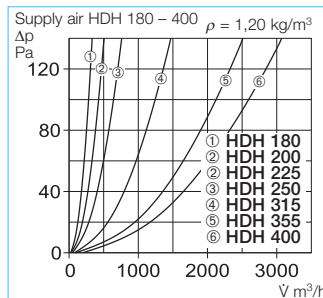

Type	Ref. no.	Nominal size	□ A	□ B	□ C	Ø E	Ø F	H	K	L	Weight net
		mm	mm	mm	mm	mm	mm	mm	mm	mm	approx. kg
HDH 180	7492	180	320	245	309	213	10	155	6 x M6	30	3.5
HDH 200	7493	200	425	330	405	259	10	198	6 x M6	30	5.0
HDH 225	7495	225	425	330	405	259	10	198	6 x M6	30	5.0
HDH 250	7496	250	580	450	450	286	10	255	6 x M6	30	8.0
HDH 315	7497	315	580	450	606	356	12	386	8 x M8	30	12.5
HDH 355	7498	355	645	535	740	395	12	452	8 x M8	30	17.5
HDH 400	7499	400	645	535	765	438	12	478	6 x M8	30	17.5
HDH 450	7491	450	730	590	860	487	12	473	6 x M8	30	26.0
HDH 500	7513	500	925	750	966	541	12	531	6 x M8	40	30.0
HDH 560	7517	560	925	750	1075	605	14	591	8 x M10	40	44.0
HDH 630	7518	630	925	750	1155	674	14	633	8 x M10	40	47.0
HDH 710	7519	710	1260	1050	1370	751	14	860	8 x M10	65	52.0

HSDV

Dim. in mm

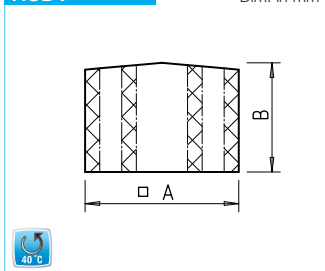

■ **Roof fan attenuator HSDV for discharge-side sound insulation**
Average attenuation value 8 dB. Available for series VD, nominal size 315 – 630. The construction encloses the roof fan and can be subsequently mounted without any structural alterations. Can only be mounted on VD series.

RS



■ **Isolator switch RS**

RS 3+1+2 Ref. no. 7536

- 3 main contacts
- 1 auxiliary contact
- 2 contacts for TB/TP

For fans with direct start-up. Polymer casing for surface mounted installation. Locking options in "0 OFF" position.

Type	Ref. no.	A in mm	B in mm
HSDV 315	7476	606	310
HSDV 355	7480	740	350
HSDV 400	7481	765	400
HSDV 450	7482	860	450
HSDV 500	7483	966	500
HSDV 560	7484	1075	550
HSDV 630	7489	1155	620

Technical data

Voltage	400 V, 3~, 50/60 Hz
Operating current	20 A
Load capacity	AC-23 B, 7.5 kW
Protection class	IP 65
Protection category	II
Actuation	Rotary drive
Temperature range	-25 to +60 °C
Weight approx.	0.3 kg
Dim. mm	W 90.5 x H 90.5 x D 102
Casing	UV and weather-resistant
Wiring diagram no.	1131

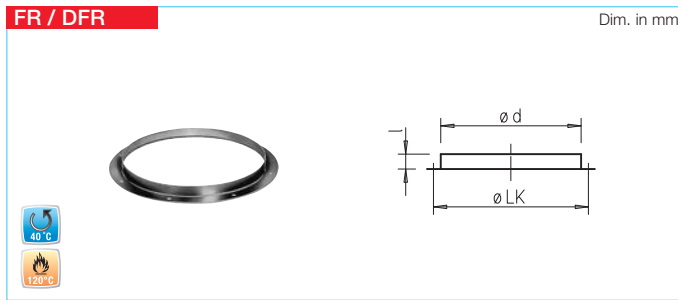

Flange rings FR
Made of galvanised sheet steel, for intake duct connections. Can be screwed directly to the fan base plate.

Dimensions according to DIN 24 155, Pt. 2.

Type	Ref. no.	Ø LK	l	Ø d	Weight approx. kg
FR 180	1200	213	25	186	0.4
DFR 200	1201	259	30	233	0.5
FR 225	1201	259	30	233	0.5
FR 250	1203	286	25	256	0.6
FR 315	1204	356	30	326	0.9
FR 355	1205	395	30	365	1.1
FR 400	1206	438	30	408	1.2
FR 450	1207	487	35	457	1.8
FR 500	1208	541	35	511	1.8
FR 560	1209	605	35	574	2.0
FR 630	1211	674	35	642	2.2
FR 710	1212	751	35	715	3.3

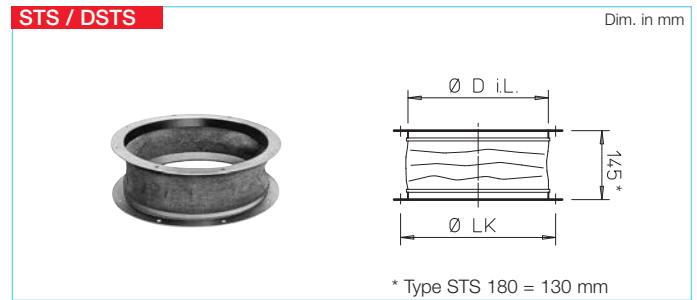

Flanged canvas connector STS
To reduce structure borne sound transmission to intake air ducting. Flanges made of galvanised sheet steel. Flexible sleeve made of polymer fabric. For ex-proof fans, type

STS Ex must be used. To be mounted directly to the fan base plate. Flange dimensions according to DIN 24 155, Pt. 2. Ambient temperature -30 °C to +80 °C.

Type	Ref. no.	Type*	Ref. no.	Ø D i.L.	Ø LK	Weight approx. kg
STS 180	1217	—	—	183	213	0.9
DSTS 200	1218	DSTS 200 Ex	2500	229	259	1.1
STS 225	1218	STS 225 Ex	2500	229	259	1.1
STS 250	1220	STS 250 Ex	2501	252	286	1.3
STS 315	1221	STS 315 Ex	2503	322	356	1.8
STS 355	1222	STS 355 Ex	2504	358	395	2.1
STS 400	1223	STS 400 Ex	2505	404	438	2.5
STS 450	1224	STS 450 Ex	2506	453	487	3.8
STS 500	1225	STS 500 Ex	2507	507	541	3.4
STS 560	1226	STS 560 Ex	2508	570	605	4.5
STS 630	1228	STS 630 Ex	2509	638	674	4.6
STS 710	1229	—	—	711	751	7.0

* for explosion-proof fans. STSB for VD T120 version see separate catalogue.

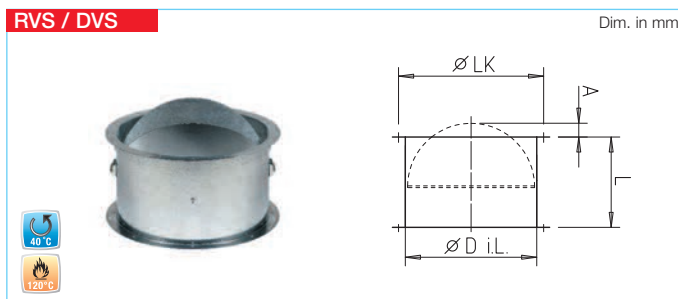

Automatic backdraught shutter with spring reverse RVS¹⁾
To prevent cold air backdraught when the fan is not in use. For vertical air flow from bottom-up (otherwise type RVM to be used). Auto matic opening function when the fan is in use. Spring mechanism outside the air flow. Holding force adjustable to fan power and

installation position. Flaps and casing made of galvanised sheet steel, flaps with nominal size 225 – 560 mm made of aluminium. Can be screwed directly to the fan base plate. Flanges on both sides. Holes pursuant to DIN 24155, Pt. 2. Ambient temperature -30 to +120 °C

Type	Ref. no.	Ø D i.L.	L	A	Ø LK	Weight approx. kg
DVS 180	1247	180	110	15	213	1.2
DRVS 200	2591	225	300	—	259	3.0
RVS 225	2591	225	300	—	259	3.0
RVS 250	2592	250	300	—	286	3.4
RVS 315	2594	315	300	—	356	4.3
RVS 355	2595	355	300	—	395	5.8
RVS 400	2596	400	330	—	438	7.2
RVS 450	2597	454	330	15	487	10.4
RVS 500	2598	504	330	40	541	11.7
RVS 560	2599	560	330	65	605	16.1
RVS 630	2600	630	400	115	674	19.5
RVS 710	2601	710	400	155	751	26.5

¹⁾ Pressure loss diagram see page 490.

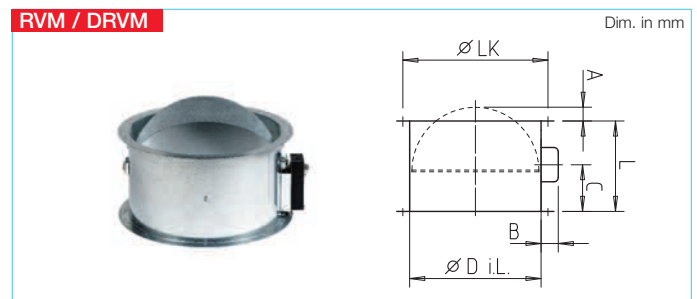

Motorised backdraught shutter RVM^{1) 2)} as RVS, but with spring reversing motor, mounted outside the air flow and for vertical air flow in any direction. Allows natural ventilation when the fan is not in use. Control of air flow in combination with a roof cowl. To be electrically operated together with the fan;

cable length 0.9 m, closed when currentless. Ambient temperature -30 to +60 °C Protection class IP 54 Voltage/Frequency 230 V AC, 50/60 Hz Power consumption - up to Ø 560 / from Ø 630 14 W/6.5 W Valve opening time, approx. 75 sec. Wiring diagram no. 380.1

Type	Ref. no.	Ø D i.L.	B	C	L	A	Ø LK	Weight aprx. kg
DRVM 200	2575	225	95	130	300	—	259	3.3
RVM 225	2575	225	95	130	300	—	259	3.3
RVM 250	2576	250	95	130	300	—	286	3.7
RVM 315	2578	315	95	130	300	—	356	4.6
RVM 355	2579	355	95	130	300	—	395	6.1
RVM 400	2580	400	95	130	330	—	438	7.5
RVM 450	2581	454	95	130	330	15	487	10.7
RVM 500	2582	504	95	130	330	40	541	12.0
RVM 560	2583	560	95	130	330	65	605	16.4
RVM 630	2609	630	150	225	400	115	674	21.0
RVM 710	2610	710	150	225	400	155	751	28.0

²⁾ Types DRVM/RVM not suitable for use in ex-areas.

FDS

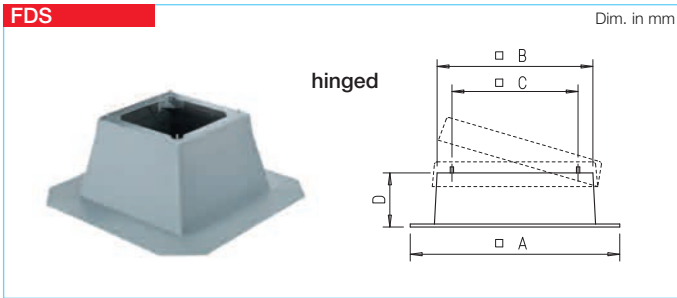

Flat roof base FDS¹⁾

For installation of roof fans and roof cowls on flat roofs. Horizontal installation. Application keeps cost and assembly effort to a minimum in comparison to manual design. Corrosion-resistant reinforced fibre glass design (nom. size 710 made of galvanised sheet steel) with abrasion-proof, sound and thermal insulation. Snow-secure base height.

Installation

To be installed above the ceiling opening (roof). Roof coating to be covered completely with felt and to be sealed bitumen-fibre kit. Includes mounting screws, profile rubber and sealing between base and base plate.

Type	Ref. no.	A in mm	B in mm	C in mm	D in mm
FDS 180*	1377	645	285	245	285
FDS 200*	1378	750	392	330	285
FDS 225*	1378	750	392	330	285
FDS 250*	1379	870	520	450	285
FDS 315*	1379	870	520	450	285
FDS 355*	1380	950	605	535	285
FDS 400*	1380	950	605	535	285
FDS 450*	1381	1000	660	590	285
FDS 500	1382	1160	820	750	285
FDS 560	1382	1160	820	750	285
FDS 630	1382	1160	820	750	285
FDS 710	6658	1550	1190	1050	285

* With hinge mechanism for simple inspection and cleaning. ¹⁾ FDS B for VD T120 see separate catalogue.

SSD

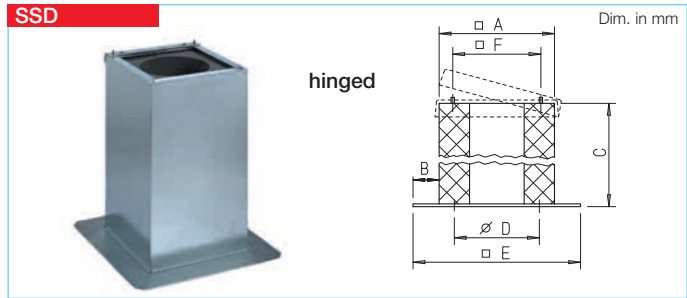

Hinged base attenuator SSD for intake-side sound insulation

Average attenuation is 15 dB. All metal parts made of galvanised sheet steel. For installation on flat roofs in the same way as a flat roof base. Delivery includes mounting screws, profile rubber and sealing between base and base plate. For nom. size 500–710: Acoustically lined with non-flammable insulation boards, class A2,

covered with glass fibre on both sides. Nom. size 180–450: Equipped with hinges to fold the fan for maintenance purposes. Foamed material with free cross-section allows access to ducting or shaft system. Base plate is equipped with threaded holes (according to DIN 24155, Pt. 2) for connection of supply air accessories.

Type	Ref. no.	A	B	C	D	E	F
SSD 180*	5289	280	160	750	213	600	245
SSD 200*	5290	400	133	735	259	666	330
SSD 225*	5290	400	133	735	259	666	330
SSD 250*	5292	520	150	835	286	820	450
SSD 315*	5292	520	150	835	356	820	450
SSD 355*	5024	600	150	985	395	900	535
SSD 400*	5291	600	150	985	438	900	535
SSD 450*	5288	675	158	985	487	990	590
SSD 500	5017	860	170	1200	—	1200	750
SSD 560	5017	860	170	1200	—	1200	750
SSD 630	5017	860	170	1200	—	1200	750
SSD 710	5287	1220	140	1500	—	1500	1050

* With hinge mechanism for simple inspection and cleaning.

WDS

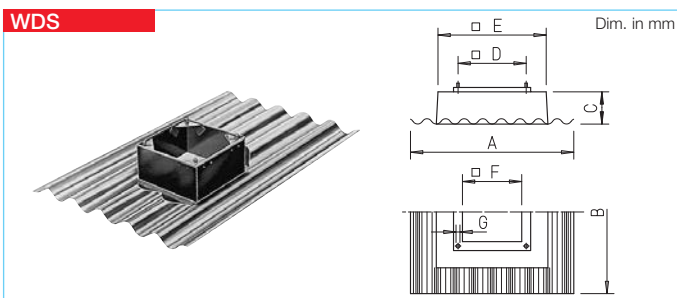

Corrugated roof base WDS

For installation of roof fans and roof cowls on corrugated roofs. Weather-resistant and corrosion-free design made from glass-fibre reinforced polyester, lightweight. No risk of breakage during shipment and on site. Low thermal transmittance value. Profile distance 177 mm (profile no. 5). Keeps planning costs and installation efforts to a minimum.

Rain drains on the front and rear chamfer between the square base and corrugated plate ensure the installation of corrugated roof panels regardless of the ceiling direction. Includes screws, washers and profile rubber for the mounting and sealing of the fan base plate.

Type	Ref. no.	A	B	C	D	E	F	G
WDS 180	1559	920	1600	200	245	295	Ø 256	M 6
WDS 200/225	1560	920	1600	200	330	395	290	M 10
WDS 250/315	1561	920	1600	200	450	555	395	M 10
WDS 355/400	1562	920	1600	200	535	625	475	M 10
WDS 450	1563	1400	2000	200	590	705	525	M 12
WDS 500/560	1564	1400	2000	200	750	895	650	M 12
WDS 630	1565	1400	2000	200	750	895	650	M 12

SDS

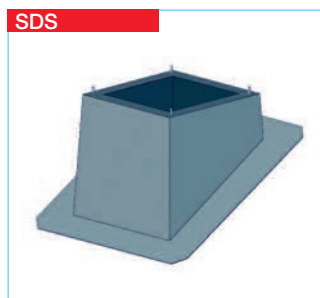

Sloping roof base SDS

For installation of roof fans and roof cowls on sloping roofs with slopes of up to 45°. Made of galvanised sheet steel, with sound and thermal insulated 50 mm thick cladding on the inside.

All SDS models are available on request. When ordering please specify the fan type or the nominal size of roof cowl, the roof pitch angle, the type of brick or the profile shape and height (for profile roofs), if necessary.

Installation

Base to be installed on the roof construction. The enclosing collar made of lead to be sealed. Includes mounting screws, plates and sealing between the base and base plate.

Information	Page
All centrifugal roof fans delivered without guard on intake. If there is no duct connected directly to the unit, a guard (model ASD-SGD or SG) must be used.	231
Other accessories	Page
Speed controllers, controllers and switches	525 on

Accessories to optimally satisfy all building requirements.



The development of accessories optimally tailored to the corresponding fan ranges is part of Helios' corporate philosophy.

SHUTTERS. GRILLES. WALL AND ROOF DUCTS.

Helios backdraught shutters, weather protection and ventilation grilles and roof and wall ducts are popular due to their pleasant shapes, practical handling and robustness.

Noise-damping volume elements and volumetric flow stabilisers are simply pushed into the duct and are efficient solutions for reducing the sound level and to adjust or stabilise the air flow volume.

488^{on}

EXHAUST, SUPPLY AND OUTDOOR AIR ELEMENTS. VALVES.

The current ventilation valves with their award-winning design, innovative exhaust air elements for demand-based functionality, preliminary filter elements, poppet valves for supply and exhaust air operation and incoming air elements for the controlled supply of outdoor air. The Helios range has ideal solutions for any type of room and use.

500^{on}

FIRE SAFETY SYSTEMS AND SHUTTER ELEMENTS.

In order to prevent the spread of fire to adjacent floors and rooms in multi-storey buildings, openings for ventilation ducts that cross fire sections are to be equipped with shut-off elements. Helios offers these for a wide range of installations and all required classifications.

516^{on}



- **Special characteristics**
 - Made of non-corrosive, weather proof, long life and ultra-violet stable polymers, colour light grey (VK 160 in white).
 - Resists most harmful atmospheres.
 - External building cladding stays clean longer as air flow channelled straight through the shutter.
 - Easy and quick installation.
 - Flat design.
 - Attractive appearance.

- **Automatic**
 - Air stream operated louvres in a compact flat design to cover exhaust air openings in walls.
 - Automatic operation; opens and closes when the fan is switched on and off.
 - Fixed to wall by means of four concealed holes in corners.
 - Supplied in individual boxes including mounting materials.
 - Maximum air flow velocity = 8 m/s.
 - Sizes 630 and 710 have an additional centre mullion to increase overall stability and sizes 800 and 900 have two mullions resulting in several louvre panels.

- **Manually adjustable**
 - To cover intake and exhaust air openings in external walls. Compact flat design. Suitable for reversible axial fans (intake and extract) as air flow in either direction is possible.
 - Rattle-free and tight insulated, as the louvres are closed by spring force via mullions.
 - Manual operation by means of pull cord via guide roller.
 - Supplied with pull cord protection, guide roller, fixing hook and mounting materials.
 - Frames, louvres with axis and adjusting parts made of UV resistant, impact resistant polymer in light grey.
 - Up to nominal size 500 the louvre has one centre mullion. For larger sizes (see "custom sizes") the models have an additional centre mullion to increase overall stability and result in several louvre panels. Each part has a separate pull cord.

- **Electrically adjustable**
 - External shutters to cover intake and exhaust air openings.
 - Automatic operation linked with fan controller. It can be wired so that the fan start is delayed until the shutter is fully opened.
 - Control of fan and shutter via remote switch to be installed on site. The limit switch in servo motor connects the fan circuit when the shutter is fully opened. Max. current 1 A (ind.). With higher currents or 3 phase fans an auxiliary relay is required (contactor, Ref. no. 99611).
 - If the fan is operated by a speed controller the shutter must be controlled via a relay installed on site.
 - Ready for installation with a lead (5 x 1,5 mm², approx. 1,5 m long). Connection according to wiring diagram no. 39 and 73.
 - Water proof motor housing, protected to IP 55, made of polymer; includes maintenance free gear box motor 230 V~, 50 Hz.
 - Made of light grey polymer, rattle free operation and tight closing.

- **Pressure loss**

When selecting a fan the pressure drop of all components of the system like ducting and shutters must be considered. The diagram shows the resistance subject to air velocity.

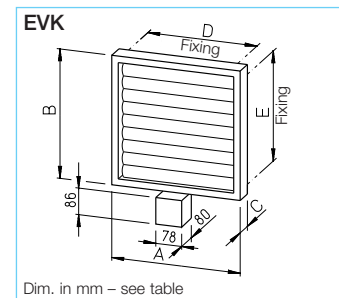
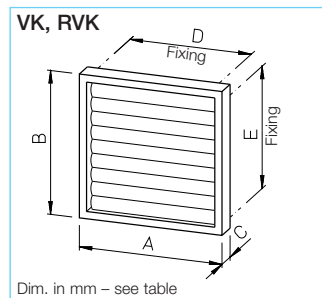
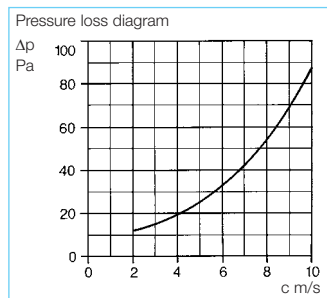

■ **Model ranges**

Automatic		Manually adjustable		Electric control		Fits fan nominal size mm	Dimensions				
Type	Ref. no.	Type	Ref. no.	Type	Ref. no.		A mm	B mm	C mm	D mm	E mm
VK 160 ¹⁾	0892	—	—	1)	1)	150/160	190	190	25	131	131
VK 200	0758	RVK 200	0766	EVK 200	0774	180/200	240	240	28	193	167
VK 250	0759	RVK 250	0767	EVK 250	0775	225/250	290	290	28	243	217
VK 315	0760	RVK 315	0768	EVK 315	0776	280/315	340	340	28	293	267
VK 355	0761	RVK 355	0769	EVK 355	0777	355	390	390	28	343	317
VK 400	0762	RVK 400	0770	EVK 400	0778	400	440	440	28	393	367
VK 450	0763	RVK 450	0771	EVK 450	0779	450	490	490	30	443	417
VK 500	0764	RVK 500	0772	EVK 500	0780	500	540	540	30	493	467
VK 630	0836			EVK 630	0781	560/630	686	690	40	520	630
VK 710	0838			EVK 710	0784	710	785	785	40	771	685
VK 800	0839					800	876	885	40	862	785
VK 900	0841					900	1026	985	40	1012	885

Larger sizes are available on request, also see custom models.

¹⁾For specification, design and dimensions of smaller shutters see following page.

■ **Accessories**

Adapter F allows installation of these shutters (up to nominal diameter 710) on circular ducting. For selection and specification see page 496.



- **Small automatic shutters made of polymer for Ø 100, 125 and 160 mm**
Airstream operated louvres to cover exhaust air openings.
- Suitable as extract outlet of small fans, cooker hoods, tumble dryers and others.
- Made of UV-resistant and impact resistant polymer.
- Fixing via spigot or masonry plugs. Sealing foam strip included in contents.

■ Model range

Type	Ref. no.	Colour	Spigot Ø mm	Qty
VK 100	0757	white	100	1
VK 100 B	0765	brown	100	1
VK 100 VE*	0885	white	100	24
VK 125	0857	white	125	1
VK 160	0892	white	150/160	1

* low-cost bulk pack



- **Small electric shutter**
To cover intake and exhaust air openings in all types of rooms.
- Attractive design blends into any decor. The view into the duct is obscured even when the shutter is open.
- Maximum air flow velocity approx. 6 m/s.
- Noise free operation with a 60 second opening delay.
- Control via on/off switch, wired in parallel by preference.

■ Model range

Type	Ref. no.	Spigot Ø mm	Weight kg
EVK 100	0453	100	0,26
EVK 150	0251	150	0,44

Break-proof polymer, alpine white.
Wiring diagram no. 479
Voltage/Frequency 230 V~, 50/60 Hz
Power consumption approx. 6 W

■ Note

Operating temp. EVK 100, EVK 150: 0 to +40 °C, for all other polymer backdraught shutters: -30 to +60 °C.



- **Rectangular shutter**
In landscape format, to cover exhaust air openings in external walls.
- Dimensions fit Helios rectangular fan range.
- Automatic operation.
- All parts made of high quality, light grey polymer.
- Fixing via dowels.
- Maximum air flow velocity = 10 m/s.

■ Model range

Type	Ref. no.	Duct nominal size cm
VK 30/15	0735	30 x 15
VK 40/20	0874	40 x 20
VK 50/25	0875	50 x 25
VK 50/30	0876	50 x 30
VK 60/30	0877	60 x 30
VK 60/35	0878	60 x 35
VK 70/40	0879	70 x 40
VK 80/50	0880	80 x 50
VK 100/50	0881	100 x 50



- **Custom sizes**
The shutter ranges
- automatic (airstream operated)
- manually adjustable
- electrical control
- are available in project specific custom sizes.
- The dimensions can be varied within steps of 50 mm. Any rectangular portrait, landscape or square dimensions are available. The shutters are manufactured to order and are non-exchangeable or returnable. Therefore the dimensions must be defined accurately.
- For more stability, an additional vertical centre mullion is fitted over 40 cm louvre length and a horizontal centre mullion over 100 cm louvre length. Large shutters are supplied in segments for stability and transport reasons and have to be assembled on frames.
- The maximum air flow velocity for standard models is 10 m/s.
- All parts (frames, shutters and their stocks) made of light grey, high quality, UV resistant polymer.

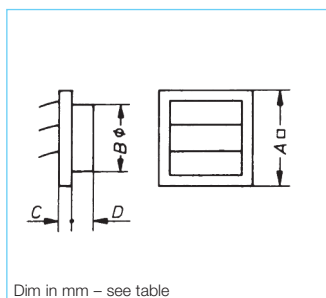

Dim in mm – see table

Type	Dim. in mm			
	A	Ø B	C	D
VK 100	140	98	15	28
VK 125	160	120-125	20	30
VK 160	190	145	25	35

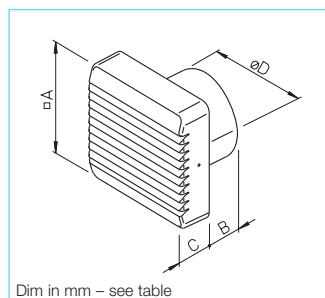

Dim in mm – see table

Type	Dim. in mm			
	□ A	B	C	Ø D
EVK 100	140	58	38,5	97
EVK 150	190	62	43	145

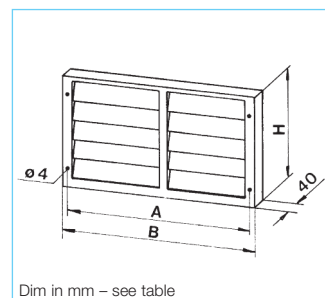

Dim in mm – see table

Type	Dim. in mm				Weight kg
	A	B	H		
VK 30/15	381	395	235		1.0
VK 40/20	473	485	285		1.3
VK 50/25	574	585	335		2.0
VK 50/30	574	585	385		2.2
VK 60/30	674	685	385		2.4
VK 60/35	674	685	435		2.6
VK 70/40	774	785	485		3.1
VK 80/50	864	876	585		4.4
VK 100/50	1162	1176	585		5.5



■ Air tight in-duct backdraught shutter RVE

- In-duct mounted, ideal for retrofit installation.
- Polymer ring with surrounding double lip seal and tight adjacent rubber membrane, which opens at low and high pressure.
- Supplied with two membranes for air flow velocity up to approx. 3.5 m/s or 6 m/s.
- At horizontal air flow the rotation axis must be in vertical position.
- Temperature range -20 to +90 °C.

■ Backdraught shutters RSK

- Automatic shutters for in-duct installation.
- Prevents back draughts (extract of warm air or intake of cold air) when the fan is switched off.
- Automatic operation at low and high pressure (rotatable mounting position) through spring blades.
- At horizontal air flow the rotation axis must be in vertical position. If installed vertically it only operates with rising air flow. To cover further requests and severe conditions use RVS or RVM.

Automatic backdraught shutter with spring release

For all horizontal ducting and vertical with the air flow upwards i.e. blades opening upwards. Blades open in air flow direction automatically by the airflow (fan operation). The spring mechanism is outside the air flow. Closing force, fan power and installation position can be adjusted. Blades and casing made of galvanised steel, at dia. 225 – 560 mm blades are made of aluminium. Flanged on both ends. Fixing holes DIN 24155, Pt. 2. Ambient temperature -30 to +100 °C

Motorised backdraught shutter¹⁾

As RVS, but with built-on spring release motor (outside the air flow), can be installed horizontally and vertically in any direction. Electrical control wired in parallel with the fan; for installation supplied with a 0.9 m long lead, closed when currentless. Ambient temperature -30 to +60 °C Protection to IP 54 Voltage/Frequency 230 V AC, 50/60 Hz Power consumption - to Ø 560 14 W - from Ø 630 6,5 W Opening time of flaps, approx. 75 sec. Wiring diagram no. 380.1

Type	Ref. no.	Ø D1	Ø D2	L	Wgt. kg
RVE 80	2584	75	83	20	0,1
RVE 100	2587	95	103	20	0,1
RVE 125	2588	120	128	20	0,1
RVE 160	2589	155	163	20	0,2
RVE 200	2618	195	203	20	0,2

Type	Ref. no.	Ø D	L	S	Wgt. kg
RSKK 100*	5106	97	57	2,0	0,1
RSKK 125*	5107	121	57	2,0	0,1
RSK 150	5073	149	100	1,25	0,5
RSK 160	5669	159	100	1,25	0,5
RSK 180	5662	170	70	0,5	0,3
RSK 200	5074	199	140	1,25	1,0
RSK 250	5673	248,5	140	1,25	1,2
RSK 315	5674	312,5	140	1,25	1,5
RSK 355	5650	352	160	0,75	1,3
RSK 400	5651	397	160	0,75	1,4

* made of polymer (temp. max. +70 °C). Remaining models made of galvanised steel, flaps made of aluminium and springs made of stainless steel.

Automatic		Motorised ¹⁾		Dim. in mm							Weight
Type	Ref. no.	Type	Ref. no.	Ø D i.L.	A	B	C	L	Ø LK	kg	
RVS 225	2591	RVM 225	2575	225	-	95	130	300	259	3,3	
RVS 250	2592	RVM 250	2576	250	-	95	130	300	286	3,7	
RVS 280	2593	RVM 280	2577	280	-	95	130	300	322	4,2	
RVS 315	2594	RVM 315	2578	315	-	95	130	300	356	4,6	
RVS 355	2595	RVM 355	2579	355	-	95	130	300	395	5,3	
RVS 400	2596	RVM 400	2580	400	-	95	130	330	438	7,5	
RVS 450	2597	RVM 450	2581	454	15	95	130	330	487	10,7	
RVS 500	2598	RVM 500	2582	504	40	95	130	330	541	12,0	
RVS 560	2599	RVM 560	2583	560	65	95	130	330	605	16,4	
RVS 630	2600	RVM 630	2609	630	115	150	225	400	674	21,0	
RVS 710	2601	RVM 710	2610	710	155	150	225	400	751	28,0	
RVS 800	2602	RVM 800	2614	800	200	150	225	420	837	37,8	
RVS 900	2603	RVM 900	2615	900	250	150	225	420	934	42,3	
RVS 1000	2604	RVM 1000*	2616	1000	300	150	225	420	1043	47,8	

¹⁾ Typen RVM not suitable for explosion proof areas.

* RVM 1000 only for horizontal through flow.

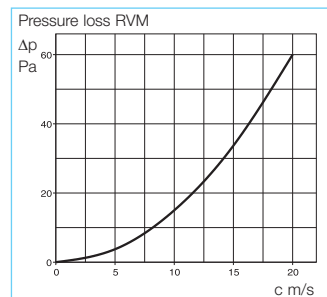
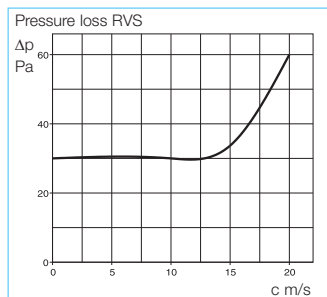
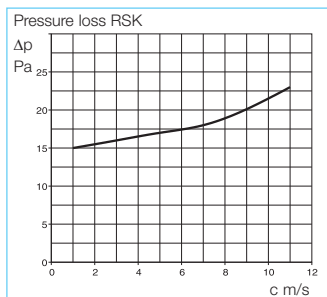
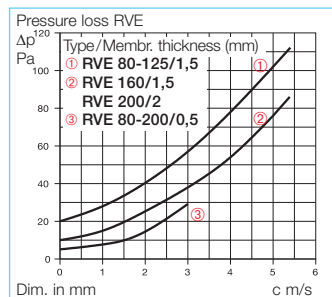
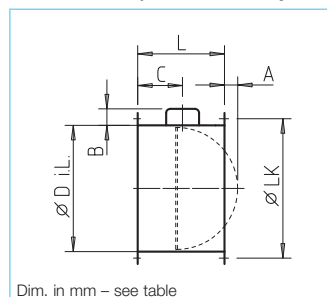
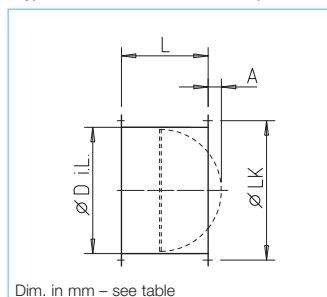
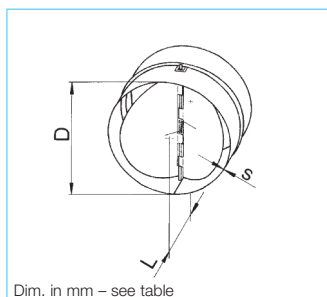
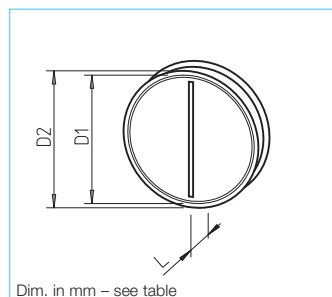

RAG



WSG



■ Rain repellent grille RAG

To cover intake and exhaust air openings in facades, made of polymer.

- Attractive, corrosion and weather resistant finish in light grey colour prevents rain, snow and insects from entering the system.
- Frame with louvres made of UVresistant, impact resistant polymer. Mesh guard made of galvanised steel and coated with polymer. Mesh size 8 mm.
- Simple (also available as surface mounted or integrated in cladding) installation via dowels (mounting materials included). With adapter F (accessory) also suitable for circular ducting.

■ Weather proof grille WSG

In square or rectangular landscape format; to cover intake or exhaust air openings in facades.

- Attractive finish protecting against rain, snow and vermin from entering the ducting. Suitable for square, rectangular and circular ducts.
- Solid construction made of aluminium extrusion profile, natural colour, anodised.
- Installation: Flush mounted or integrated in cladding.
- Fixed louvres and mesh guard behind made of galvanised steel. Mesh size: 16 mm.

■ The rectangular models

fit the Helios rectangular fan range and therefore can be fitted to rectangular ducting.

Type	Ref. no.	to fan nominal size mm	Dimensions in mm				Weight kg
			□ B	C	D	E	
RAG 200	0750	180/200	240	28	193	167	0,35
RAG 250	0751	225/250	290	28	243	217	0,45
RAG 315	0752	280/315	340	28	293	267	0,60
RAG 355	0753	355	390	28	343	317	0,75
RAG 400	0754	400	440	28	393	367	1,00
RAG 450	0755	450	490	30	443	417	1,35
RAG 500	0756	500	540	30	493	467	1,60

Type	Ref. no.	Fits to		Dim. in mm		Weight kg
		fan nom. size	spigot in mm	□ b	□ B	
WSG 200	0117	180/200	□ 200	195	271	0,8
WSG 250	0118	225/250	□ 250	245	321	1,0
WSG 315	0119	280/315	□ 315	310	386	1,5
WSG 355	0120	355	□ 355	350	426	2,0
WSG 400	0121	400	□ 400	395	471	2,5
WSG 450	0122	450	□ 450	445	521	3,0
WSG 500	0123	500	□ 500	495	571	3,5
WSG 630	0124	600/630	□ 630	625	701	4,0
WSG 710	0125	710	□ 710	705	781	4,5

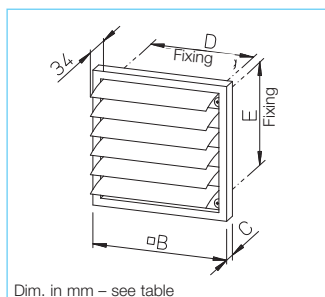

Type	Ref. no.	Fits to nominal size duct in mm	Dim. in mm				Weight kg
			b	B	h	H	
WSG 30/15	0108	300 x 150	296	370	146	220	0,9
WSG 40/20	0109	400 x 200	396	470	196	270	1,2
WSG 50/25	0110	500 x 250	496	570	246	320	1,9
WSG 50/30	0111	500 x 300	496	570	296	370	2,0
WSG 60/30	0112	600 x 300	596	670	296	370	2,2
WSG 60/35	0113	600 x 350	596	670	346	420	2,4
WSG 70/40	0114	700 x 400	696	770	396	470	2,9
WSG 80/50	0115	800 x 500	796	870	496	570	4,0
WSG 100/50	0116	1000 x 500	996	1070	496	570	5,0

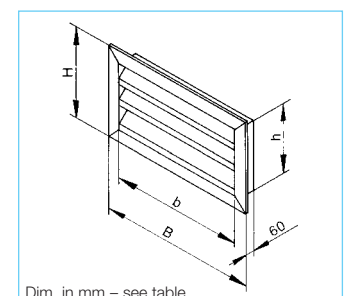
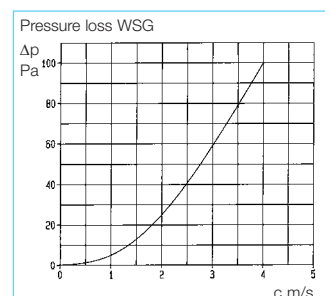
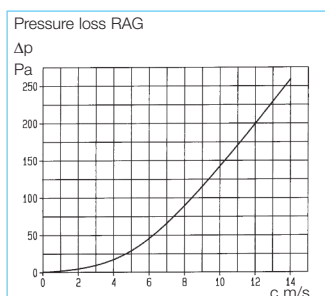

LGR



■ Grilles LGR

Rectangular with adjustable louvres.

- To cover rectangular intake or exhaust air openings especially for flat ducting.
- Centrally adjustable louvres allow the adjustment of air flow volume.
- Corrosion resistant design made of galvanised steel in a white epoxy finish.
- Includes mounting frame which allows universal installation. When installing in thin walled ducts it must be fixed with 4 screws.

■ Model range

Type	Ref. no.	Fits nominal duct openings in mm
LGR 250/150	0927	228 x 128
LGR 450/150	0928	428 x 128
LGR 350/230	0929	328 x 208
LGR 450/230	0930	428 x 208

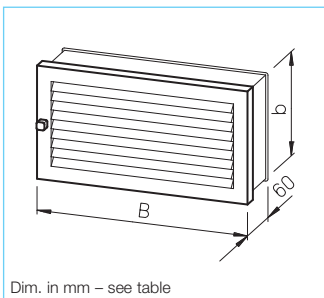

Dim. in mm – see table

Type	Free cross section cm ²	Dim. in mm B	Dim. in mm b	Wgt. kg
LGR 250/150	160	250	150	0,6
LGR 450/150	320	450	150	1,0
LGR 350/230	430	350	230	1,2
LGR 450/230	575	450	230	1,5

QVK



■ Grilles QVK

Square, with adjustable louvres.

- To cover intake or exhaust air openings with a square cross section.
- Centrally adjustable louvres allow the adjustment of air flow volume.
- Corrosion resistant design made of galvanised steel in a white epoxy finish.
- Includes mounting frame. Thereby suitable for flush mounted wall installation and without frame suitable for fixing via screws.

■ Model range

Type	Ref. no.	Fits up to fan size nominal size mm
QVK 200	0791	200
QVK 250	0792	250
QVK 315	0793	315
QVK 355	0794	355
QVK 400	0795	400

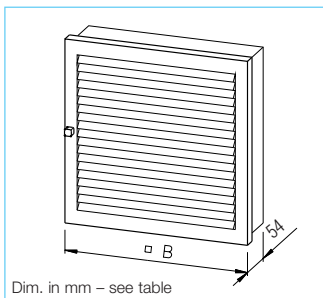

Dim. in mm – see table

Type	Free cross section cm ²	Dim. in mm B	Weight kg
QVK 200	320	□ 250	0,8
QVK 250	490	□ 300	1,0
QVK 315	680	□ 350	1,3
QVK 355	920	□ 400	1,8
QVK 400	1190	□ 450	3,2

G 200–500



■ Grilles G fixed

To cover vents on walls and ceilings.

- Made of high quality, UV-resistant and impact resistant polymer.
- Compact flat design. Simple fixing via mounting materials which are included.
- Some models obscure view into ducting when installed.

■ Model range

Type	Ref. no.	Colour	Fits to fan size mm
G 200	0255	white	200
G 250	0256	white	250/280
G 315	0798	white	315
G 355	0799	white	355
G 400	0800	white	400
G 500	0801	light grey	450/500

G 200 and 250

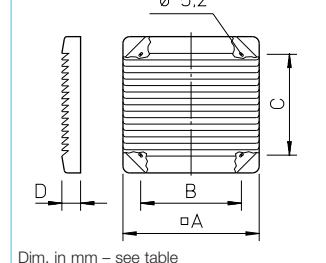

Dim. in mm – see table

G 315 – 500

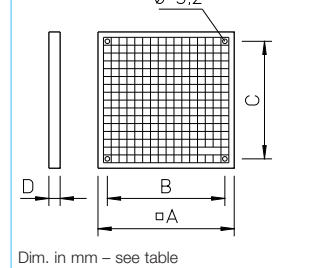

Dim. in mm – see table

Type	□ A	B	C	D	Ø	Wgt. kg
G 200	287	210	210	39	5,2	0,7
G 250	337	240	240	39	5,2	0,9
G 315	340	300	300	22	5,2	0,4
G 355	390	350	350	22	5,2	0,4
G 400	440	400	400	22	5,2	0,6
G 500	540	490	465	30	5,2	1,8

G 100, 160



■ Grilles G fixed

To cover and insert in circular vent openings.

- Made of high quality and impact resistant polymer. Corrosion resistant and therefore suitable for indoor and outdoor applications.
- Simple installation using rear connecting sockets with conical shape. Foam strip for air tight connection is included. Fixed installation is ensured via four corner holes. Egg grille inserts can easily be removed for cleaning even when fixed.

■ Model range

Type	Ref. no.	Nom. size in mm	Colour	Qty
G 100	0796	90/100	white	1
G 100 B	0782	90/100	brown	1
G 100 VE*	0828	90/100	white	12
G 160	0893	150/160	white	1

* low cost quantity pack

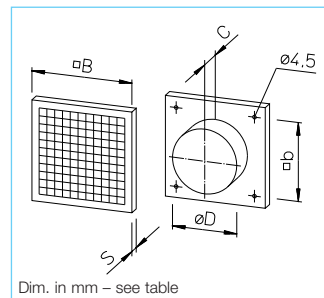

Dim. in mm – see table

Type	□ b	□ B	C	S	Ø D	Wgt. kg
G 100	90	140	28	15	100	0,8
G 160	130	190	40	24	150	0,3

LG



■ Grilles LG

With pitched louvres to cover circular vent openings of Ø 80, 100, 125 and 160 mm.

- High quality and attractively designed cover.
- Pitched louvres obscure the view into ducting when installed.
- Made of corrosion resistant die casting aluminium, powder coated. Colour: White. LGK 80 made of high quality and impact resistant polymer, Colour: White.
- Simple installation in ducting using rear spigots fixing springs and sealing tape.

LTG



■ Door grilles LTG

Fixed air transfer grilles for installation into door leaves.

- Attractive and unobtrusive design, made of high quality and impact resistant polymer in light grey or brown.
- With wide surroundings and pitched louvres to obscure view. Only 3 mm visible thickness.
- Two telescopic parts. Installation: One element of the grille to be pushed in from either side of the door. Pulled together and tightened by the fixing screws.

■ Model range

Type	Ref. no.	Weight in grams
LGK 80*	0259	120
LGM 100	0254	300
LGM 125	0258	450
LGM 160	0261	750

* made of polymer

Type	Dim. in mm			
	A	B	C	D
LGK 80	135	105	14	80
LGM 100	155	127	16	95
LGM 125	195	150	25	120
LGM 160	252	190	25	155

■ Model range

Type	Ref. no.	Colour
LTGW	0246	white
LTGB	0247	brown

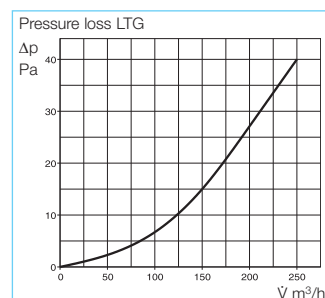
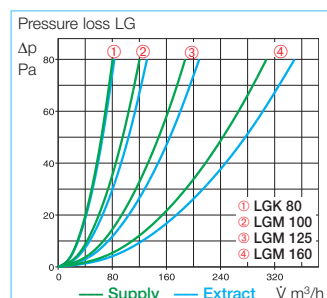
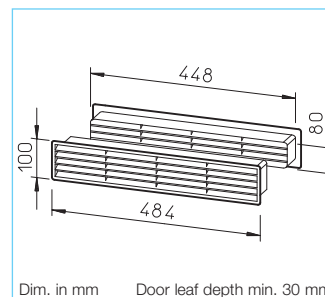
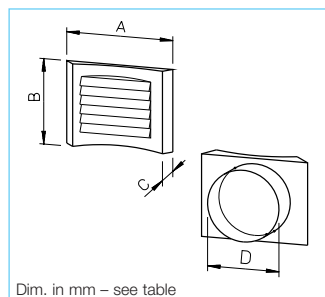

Roof appliances

FDH

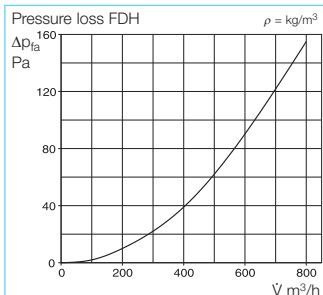
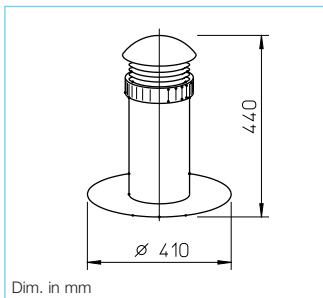

Type FDH Ref. no. 1477
Flat roof outlet

For connection of vent openings, up to 160 mm diameter, via the roof. Made of weather resistant polymer with a wide frame for fixing. Cold and heat resistant up to +200 °C. Cowl can be removed by insertion of a supplied ladder strip or insulation material (on site) to prevent the occurrence of condensation.

Roof outlet DH with roof pantiles FDP, UDP and connector STV

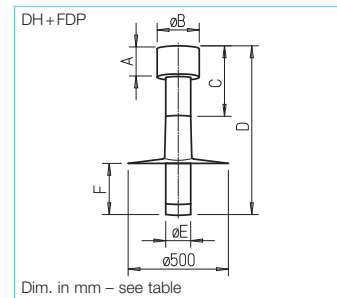
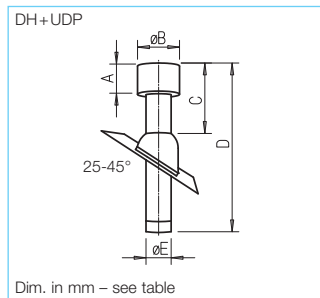

Roof outlet DH

The ideal solution for ventilation system, without static pressure drop. Made of weather resistant polypropylene, removable exhaust outlet with protection against driving rain. Connection with ducting by means of the connector STV (accessory), which obstructs the escape of condensation at the juncture. For the installation of the roof outlet, the following roof pantiles should be used:

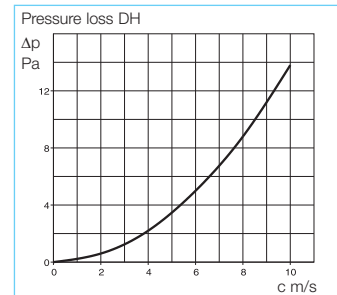

- **Roof pantile UDP**, fits almost to every brick model, in black or brick-red. For roofs with inclinations of 25–45°.
- **Flat roof pantile FDP** made of aluminium for flat roofs.

■ **Model range: Outlet, pantile, connector to be ordered separately.**

DN mm	Roof outlet*		Roof pantile*, lead		Roof pantile for flat roof, alu.		Connector	
	Type	Ref. no.	Type	Ref. no.	Type	Ref. no.	Type	Ref. no.
100	DH 100 R	2014	UDP 100 R	2020	FDP 100	2024	STV 100	2026
	DH 100 S	2015	UDP 100 S	2021				
125	DH 125 R	2016	UDP 125 R	2020	FDP 125	2013	STV 125	2027
	DH 125 S	2017	UDP 125 S	2021				
160	DH 160 S	2019	UDP 160 S	2023	FDP 160	2025	STV 160	2028

* R = Brick-red, S = Black

■ **Dimensions: Roof outlet DH with roof pantile UDP or FDP**

DN mm	Dimensions in mm					
	A	Ø B	C	D	Ø E	F
100	120	170	320	785	100	225
125	140	210	335	825	125	255
160	180	265	365	1113	160	345

Roof and wall appliances

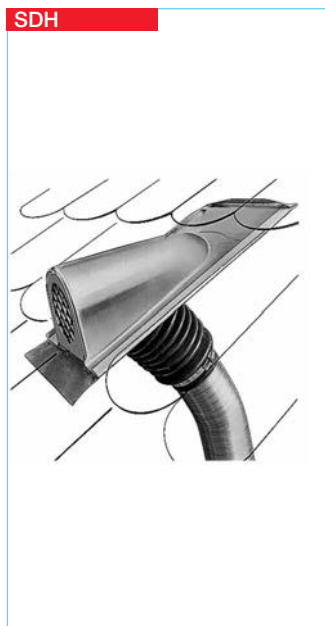

Universal roof appliances

For air inlet/outlet or for connection to ducting of \varnothing 125 – 400 mm. Cowl brick-red or slate grey as optional.

A large leaded sheet allows adaptation to all tile profiles on pitched roofs. Also suitable for flat roofs. Carrier plate for fixing. All remaining parts made of galvanised steel.

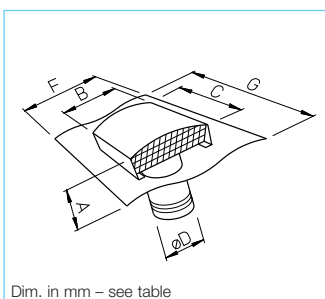

Dim. in mm – see table

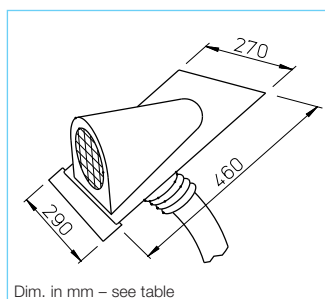

Dim. in mm – see table

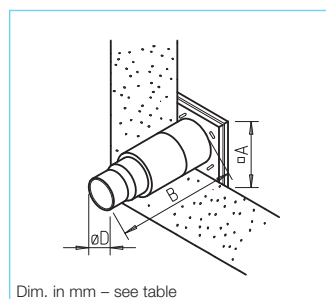

Dim. in mm – see table

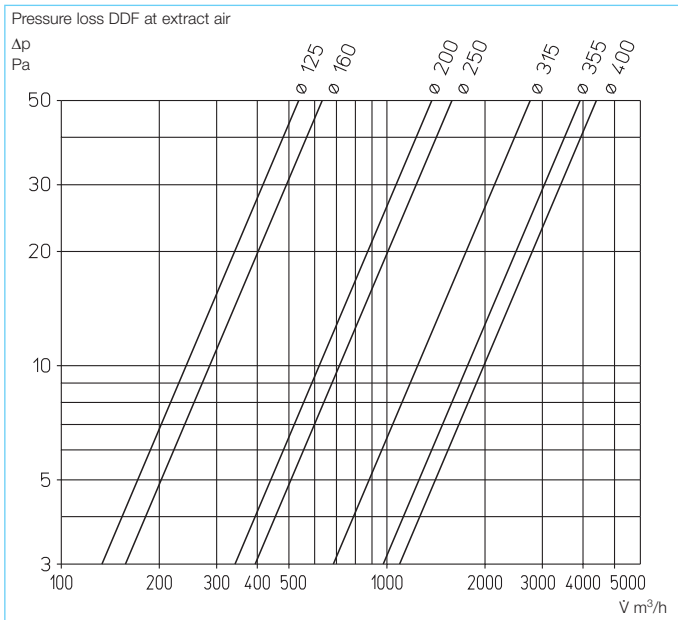

Type SDH Ref. no. 1476

Pitched roof outlet

Universal design, suitable for most tile profiles. The large leaded sheet allows adaptation to different tile profiles. Cowl and mounting plate made of galvanised steel. Flexible polymer tube with stepped spigot for connection of all duct diameters from 70 – 115 mm. Duct fixing via supplied hose clamp.

Telescopic wall sleeve

For wall applications of supply and extract air ducting. Two telescopic polymer sleeves can be adapted to suit the wall thickness with air stream operated outdoor shutter or grille. Internal spigot suitable for connection of ducting. TMK 125/150 with stepped spigot in \varnothing 125, 150 and 160 mm. TMK 100 for duct \varnothing 100 mm.

Model range and dimensions

Type	TMK 100	TMK 125 / 150
Ref. no.	0844	0845
Dim. A mm	140 □	190 □
B max.	500	500
Ø D	100	125/150/160

Model range and dimensions DDF

Type ¹⁾	Ref. no.	Type ²⁾	Ref. no.	Dimensions in mm						Weight kg
				A	B	C	Ø D	F	G	
DDF 125	1964	DDF 125 G	1848	124	200	328	125	500	400	4
DDF 160	1965	DDF 160 G	1849	135	248	396	160	500	400	4
DDF 200	1966	DDF 200 G	1850	185	333	495	200	600	600	8
DDF 250	1967	DDF 250 G	1851	185	333	495	250	600	600	8
DDF 315	1968	DDF 315 G	1852	197	420	666	315	600	600	9
DDF 355	1969	DDF 355 G	1853	350	550	900	355	900	750	17
DDF 400	1970	DDF 400 G	1854	350	550	900	400	900	750	17

¹⁾ Outlet brick-red painted (RAL 8012)

²⁾ Outlet slate grey painted (RAL 7024)



T-pieces
made of galvanised steel.

Type	Ref. no.	Nominal Ø mm
TS 100	1479	100
TS 125	5720	125
TS 160	5805	160



Duct connector
made of galvanised steel.

Type	Ref. no.	Nominal Ø mm
RVB 80	5993	80
RVB 100	5994	100
RVB 125	5995	125
RVB 160	5987	160
RVB 200	5997	200
RVB 250	5998	250
RVB 315	5999	315
RVB 355	5991	355
RVB 400	5992	400



Reducers
made of galvanised steel or polymer.*

Type	Ref. no.	Nominal Ø mm	reduced Ø mm
RZ 100/80*	5223	100	80
RZ 125/100*	5222	125	100
RZ 160/125	5729	160	125
RZ 160/150*	7684	160	150
RZ 200/160	5710	200	160



Hose clamps
A steel band with a snap on tension lock. Supplied in quantities of 10 pieces.

Type	Ref. no.	Nominal Ø mm
SCH 80/100	5722	80 – 115
SCH 125/160	5723	115 – 165
SCH 200	5724	165 – 215
SCH 250	5725	215 – 265
SCH 315/355	5727	265 – 375
SCH 400	5728	375 – 425

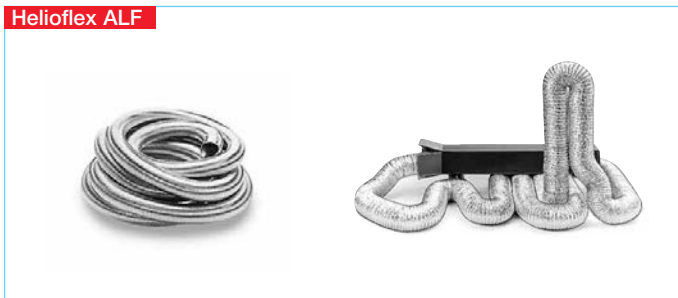

■ Flexible ducting for universal use in the most industrial, commercial and domestic applications such as general ventilation and air-conditioning technology, outlets of cooker hoods and tumble dryers etc.

- **Special characteristics**
 - Avoids storage, transportation and capacity issues.
 - A carton of approx. 60 cm length incorporates 10 m ducting.
 - Optimal in handling and finish.
 - Smallest possible bending radius.
 - Super elastic, can be bent repeatedly with no fatigue of material or leakage.
 - Self extinguishing in the event of fire.
- **Specification**
 - Two layers of polyester foil, aluminium coated.
 - Incorporated spring steel spiral for rigidity.
 - No toxic fumes in event of fire.
 - Temperature range from -20 to +100 °C.
 - Maximum pressure: 2500 Pa
 - Maximum allowed air flow speed: 20 m/s.

Type	Ref. no.	Nominal Ø mm	Inner Ø mm	Weight for 10 m	Contents per unit
ALF 80	5711	80	80	1.2	10 m
ALF 100	5712	100	102	1.4	10 m
ALF 125	5713	125	127	1.9	10 m
ALF 160	5757	160	160	2.5	10 m
ALF 200	5715	200	203	4.8	10 m
ALF 250	5716	250	254	5.3	10 m
ALF 315	5717	315	315	9.3	10 m
ALF 355	5758	355	356	9.7	10 m
ALF 400	5759	400	406	11.2	10 m

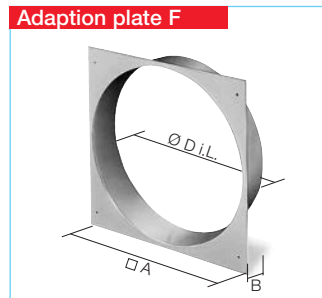

- **Adaption plate F to square shutters for circular ducting / fans.**
 - Use: By using this adaptor, the shutter ranges VK, RVK, EVK and RAG can be mounted directly to circular ducting or fan spigots (HQ/HW).
 - Installation: The four holes in the corners match the fixing points of the shutters. The circular spigot fits over the fan's casing and is fixed with screws.
 - Material: Made of galvanised steel.

■ **Model range**

Type	Ref. no.	Shutter size cm	Dim. in mm		
			□ A	B	Ø D. i. L.
F 200	0804	20	240	55	210
F 250	0805	25	290	55	259
F 315	0807	30	340	55	324
F 355	0808	35	390	55	364
F 400	0809	40	440	55	409
F 450	0810	45	490	55	460
F 500	0811	50	540	55	510
F 560/630	0257	63	685	55	570
F 630 ¹⁾	0813	63	685	55	640
F 630 ²⁾	0826	63	685	55	630
F 710 ¹⁾	0824	71	785	55	717
F 710 ³⁾	0825	71	785	55	710

¹⁾ For Type HQ ²⁾ For Type HW
³⁾ For Type AVD DK



Type AS 100 Ref. no. 5224
Connection spigot
square flange plate (102 x 102 mm) with circular spigots (50 mm long), made of polymer.
To connect ducting (DN 100 mm) on flat surfaces.

- The innovative SVE elements have low cost solutions for:
- Air flow volume adjustment and optimised distribution in ducting system of centralised ventilation units.
 - Sound level reduction through absorption of air flow and fan noises.

In order to increase the sound level reduction, several elements can be mounted in series, one after the other. Two elements virtually doubling the insertion loss.

Performance figures and insulation standards

The diagrams give an overview about air flow volumes and pressure levels according to the number of holes. The red lines and dB(A) values show the noise levels of elements (L_{WA}). The sound power levels for the related frequency (noise level of SVE elements) are available as sum levels in the installation manuals and operating instructions. The values on the table give the insulation standard D_e for the corresponding frequency.

Material

- Fire retardant foam material with protection against mould.
- Meets the requirements of the emission category M1.
- No harmful toxic fumes in event of fire.
- Complies with fire class B.

Advantages

- Cost effective solution for prevention of noise transfer in ventilation ducting systems.
- Simple installation through insertion into the ducting.
- Simple adjustment thanks to pre-punched holes.
- Minimises the system costs by using low cost ducting.
- Can be used with all types of dampers, grilles and valves.
- Can be easily cleaned with a vacuum cleaner.

Delivery

Each element is delivered in a separate poly-bag.

Installation

SVE to be inserted into the ducting and a valve grille or exhaust element can be used as wall termination. By removing the elliptical plugs, the air flow can be adjusted to the desired volume in accordance with the diagrams above.

SVE

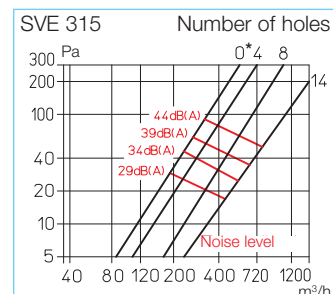
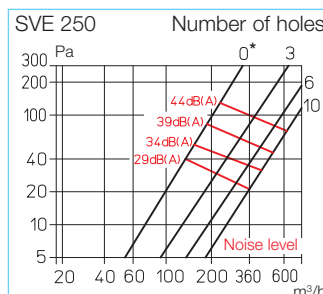
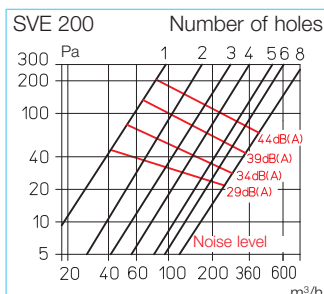
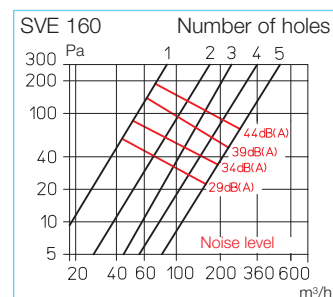
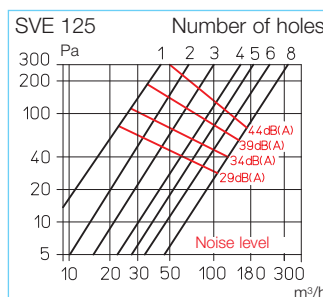
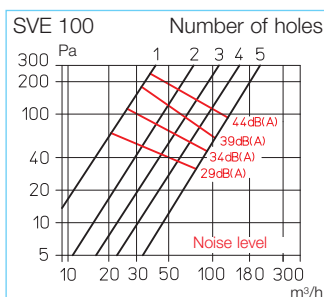
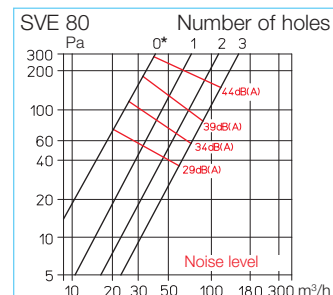

Ordering data						Insulation standard D_e dB bei Hz							
Type	Ref. no.	for DN (mm)	Thick. in mm	Weight in g	Holes	125	250	500	1000	2000	4000	8000	
SVE 80	8309	80	50	32	0*	9.0	5.0	11.5	14.5	18.0	20.0	24.0	
					1	4.5	3.5	7.5	11.5	10.5	17.5	21.0	
					3	4.5	2.5	5.0	8.0	9.5	13.0	15.5	
SVE 100	8310	100	50	60	1	7.0	4.0	9.5	12.5	16.0	17.5	22.0	
					3	3.5	2.5	5.5	8.5	8.5	14.5	19.0	
					5	2.5	1.5	3.5	6.0	6.5	12.0	16.5	
SVE 125	8311	125	50	70	2	6.0	5.0	5.0	12.0	12.5	19.0	21.0	
					5	2.0	2.5	3.0	8.5	8.0	13.5	19.0	
					8	1.5	1.5	2.5	6.0	5.0	11.0	17.5	
SVE 160	8312	160	50	140	1	7.0	4.0	9.5	12.5	16.0	17.5	22.0	
					3	3.5	2.5	5.5	8.5	8.5	14.5	19.5	
					5	2.5	1.5	3.5	6.0	6.0	12.0	16.5	
SVE 200	8313	200	50	190	2	6.5	2.5	5.5	13.0	14.0	18.0	15.5	
					5	3.0	1.5	2.5	9.5	8.5	14.0	14.5	
					8	2.0	1.0	1.5	7.0	7.0	13.0	13.5	
SVE 250	8314	250	75	480	0*	4.0	3.0	7.0	13.0	18.0	18.0	17.0	
					5	2.0	2.0	5.0	9.0	13.0	15.0	15.0	
					10	2.0	1.0	3.0	7.0	11.0	14.0	13.0	
SVE 315	8315	315	75	690	0*	5.0	3.0	6.0	12.0	15.0	16.0	18.0	
					8	3.0	2.0	3.0	8.0	12.0	13.0	15.0	
					14	1.0	1.0	2.0	7.0	8.0	10.0	13.0	

* Minimum air flow volume ensured by lateral recesses

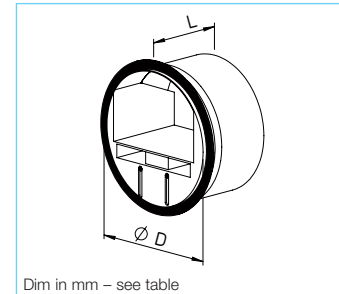

Automatically achieving constant air flow volume the VKH is an easy and low cost solution that ensures a constant air flow volume desired for a wide range of pressures.

■ Operation

Simply insert the automatic volume stabiliser in the duct or duct components, either supply or extract. The VKH gives the preset air volume over a differential pressure range of approx. 50 – 200 Pa.

■ Advantages

- Measuring and balancing on building site omitted; thereby the system can be commissioned faster.
- Secure and simple design.
- Ensuring a constant air flow volume, even at low counter pressure.

- Easy change of air flow volume for each diameter of VKH. Thereby the other system inlets and outlets are not affected.

- Automatic adjustment to give constant air flow volume over a wide pressure range.

- Quick installation.

- Made of flame retardant polymer, class B1 DIN 4102-1.

■ Function

- With an increasing pressure level the air flow velocity increases. The pressure against the butterfly valve decreases the opening cross section and keeps the air flow volume constant.

- At the minimum static pressure level the butterfly valve opens the cross section completely.

- The guiding cylinder is responsible for an equal movement of flaps and controls therefore the relation between pressure and air flow volume.

■ Installation

- Simple insertion in vertical or horizontal ducts, matching nominal duct diameter.

- The direction shown for the air flow must be considered.

- Perfect fitting and tightness is ensured due to textile sealing strip.

**Installation extract:
Discharge = 1 x D**

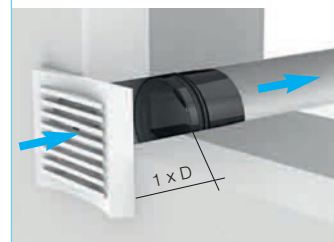

**Installation supply:
Discharge = 3 x D**

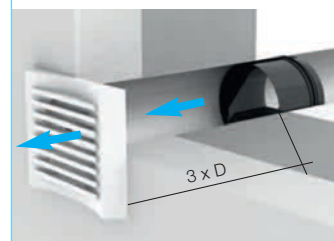

Model range	Dim. in mm			Air flow range
	Ø nom. duct	Ø D	L	m³/h
VKH 80	80	76	55	15-50
VKH 100	100	96	70	15-100
VKH 125	125	120	86	100-180
VKH 150-160	150-160	146	91	180-300
VKH 200	200	190	91	300-500
VKH 250	250	245	127	500-700

m³/h	Selection chart					
	Ø 80	Ø 100	Ø 125	Ø 150-160	Ø 200	Ø 250
15-50	80/15-50	100/15-50	125/15-50			
50-100		100/50-100	125/50-100	150-160/50-100		
100-180			125/100-180	150-160/100-180	200/100-180	
180-300				150-160/180-300	200/180-300	250/180-300
300-500					200/300-500	250/300-500
500-700						250/500-700

Assembly

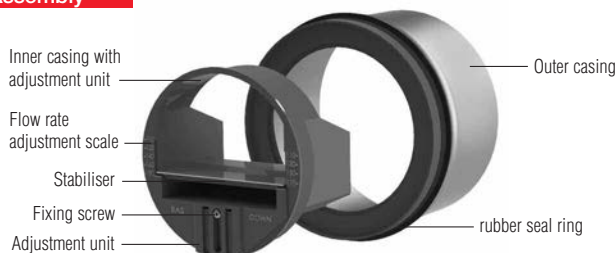

Ø 80 mm nominal duct diameter

Ref. no.	Type	Air flow volume* m³/h	Sound L _w in dB(A) at			
			50 Pa	100 Pa	150 Pa	250 Pa
0001	VKH 80/15-50	15-50	25	29	32	35

* Tolerance range (50-250 Pa) for nominal air flow volume +/- 10%.

VKH 80

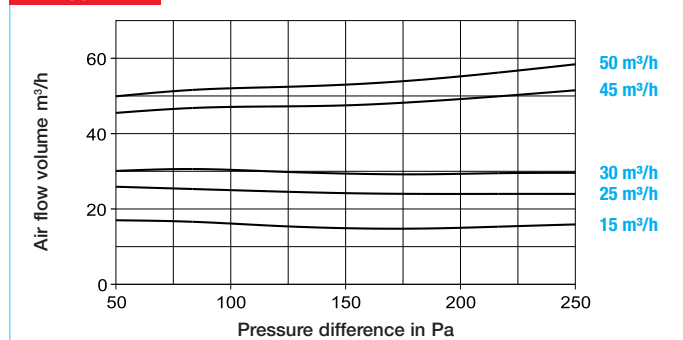

Ø 100 mm nominal duct diameter

Ref. no.	Type	Air flow volume* m³/h	Sound L _w in dB(A) at			
			50 Pa	100 Pa	150 Pa	250 Pa
0002	VKH 100/15-50	15-50	25	29	32	35
0003	VKH 100/50-100	50-100	32	37	39	42

* Tolerance range (50-250 Pa) for nominal air flow volume +/- 10%.

VKH 100

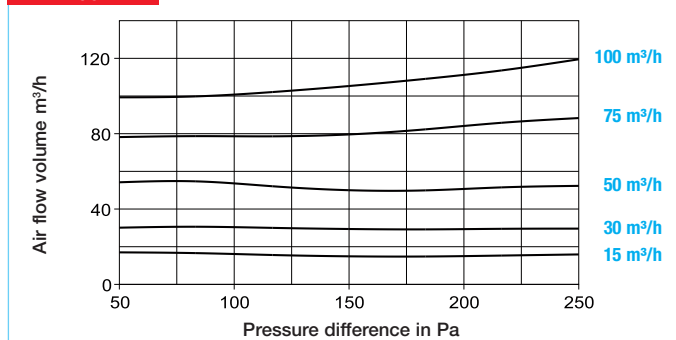

Ø 125 mm nominal duct diameter

Ref. no.	Type	Air flow volume* m³/h	Sound L _w in dB(A) at			
			50 Pa	100 Pa	150 Pa	250 Pa
0004	VKH 125/15-50	15-50	25	29	32	35
0005	VKH 125/50-100	50-100	32	37	39	42
0006	VKH 125/100-180	100-180	30	37	39	42

* Tolerance range (50-250 Pa) for nominal air flow volume +/- 10%.

VKH 125

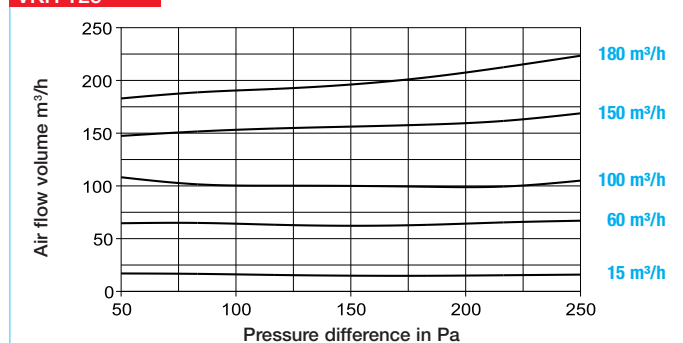

Ø 150-160 mm nominal duct diameter

Ref. no.	Type	Air flow volume* m³/h	Sound L _w in dB(A) at			
			50 Pa	100 Pa	150 Pa	250 Pa
0007	VKH 150-160/50-100	50-100	32	37	39	42
0008	VKH 150-160/100-180	100-180	30	37	39	42
0009	VKH 150-160/180-300	180-300	34	40	42	44

* Tolerance range (50-250 Pa) for nominal air flow volume +/- 10%.

VKH 150-160

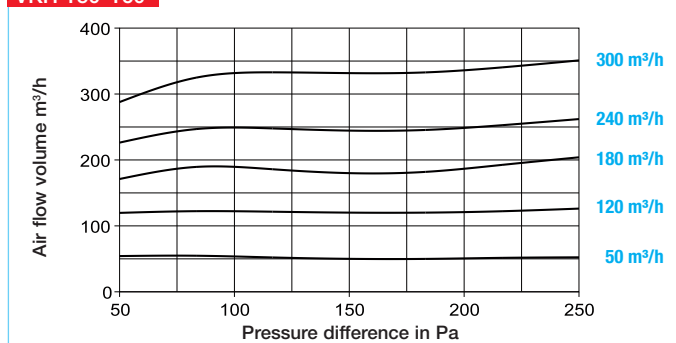

Ø 200 mm nominal duct diameter

Ref. no.	Type	Air flow volume* m³/h	Sound L _w in dB(A) at			
			50 Pa	100 Pa	150 Pa	250 Pa
0010	VKH 200/100-180	100-180	30	37	39	42
0011	VKH 200/180-300	180-300	34	40	42	44
0012	VKH 200/300-500	300-500	35	40	44	47

* Tolerance range (50-250 Pa) for nominal air flow volume +/- 10%.

VKH 200

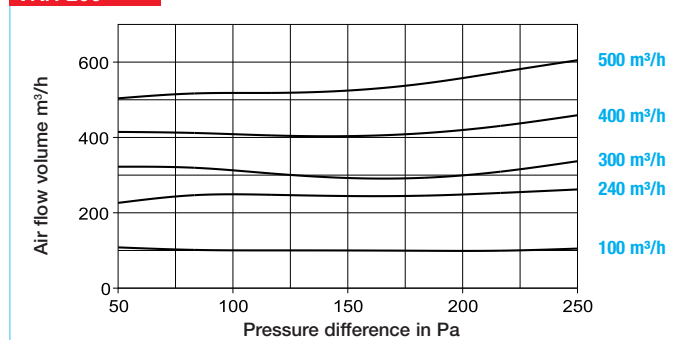

Ø 250 mm nominal duct diameter

Ref. no.	Type	Air flow volume* m³/h	Sound L _w in dB(A) at			
			50 Pa	100 Pa	150 Pa	250 Pa
0013	VKH 250/180-300	180-300	30	37	39	42
0014	VKH 250/300-500	300-500	35	40	44	47
0015	VKH 250/500-700	500-700	36	40	46	49

* Tolerance range (50-250 Pa) for nominal air flow volume +/- 10%.

VKH 250

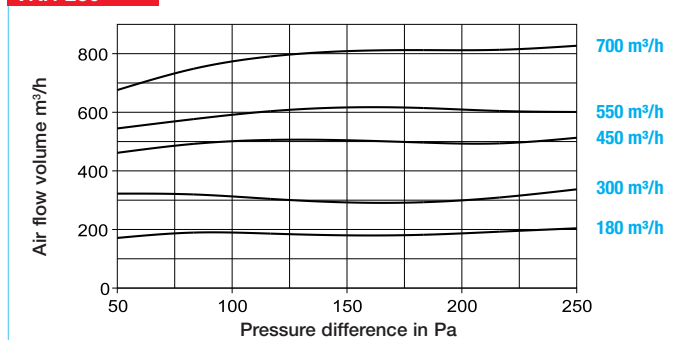

The ideal solution for all
types of room and use.



**OUTSIDE AIR FLOW
SUPPLY ELEMENTS**

EXTRACT AIR ELEMENTS

Alongside the fan, extract air elements form the basis for demand-optimised function in central ventilation systems. By equipping them with varying air flow volumes or time, motion and moisture control fulfil, the innovative extract air elements (AE) from Helios are ideal for fulfilling requirements in this area.

501^{on}

**FILTER ELEMENTS
ATTENUATORS**

Preliminary filter elements prevent the build-up of fat and dust on extract air elements and poppet valves, as well as in the ducting system.

Slide-in cross-talk sound attenuators reduce the noise from the ducting system and telephony from one residential unit to another.

504

**VENTILATION AND
POPPET VALVES**

The ventilation valves (DLV), the design of which has won several awards, fit in beautifully and inconspicuously in any home atmosphere.

Conventional poppet valves for exhaust air and supply air operation are ideally suited for various industrial and commercial applications.

506^{on}



Outside air elements are the most efficient way of ensuring the scheduled supply of air in compliance with the standards. The number, size and placement of the elements are to be defined such that the required volume can be dosed and can flow in without causing a draught. According to DIN 1946-6, it should be taken into account when sizing the extract air elements that an indoor pressure is not more than around 8 Pa below the outside pressure.

512^{on}



Selection

Extract air elements only optimally perform the required function when they are coordinated with the task. Use the chart below to select the correct extract element where the selection depends on volume and application. There is a choice of element designs, with constant air flow volume with and without on demand ventilation, with timer, motion or humidity controlled operation.

Bathroom 		WC 		Kitchen 	
Type	Ref. no.	Type	Ref. no.	Type	Ref. no.
Constant air flow volume controller, self-adjusting					
AE 45*	2031	AE 30*	2030	AE 75*	2033
Two air flow volumes (std. and demand-based ventilation), constant air flow control, self-adjusting					
AE GB 20/75*	2036	AE GB 15/30*	2035	AE GB 45/120*	2038
Two air flow volumes with electrical timer (without constant air flow volume control)					
AE GBE 30/60*	2047	AE GBE 15/30*	2044	AE GBE 45/120*	2048
Two air flow volumes with electrical timer and motion sensor, page 503					
		AE B 15/30*	2055	(without constant air flow control)	
Humidity controlled with variable, limited air flow volume, page 503					
AE Hygro 10/45*	2049				
Humidity controlled with electrically controlled on demand ventilation, page 503					
AE Hygro GBE 5/40/75*	2053			AE Hygro GBE 10/45/120*	2054
With filter and air flow volume adjustment					
AE FV 125	9478			AE FV 125	9478

* Air flow volume in m³/h

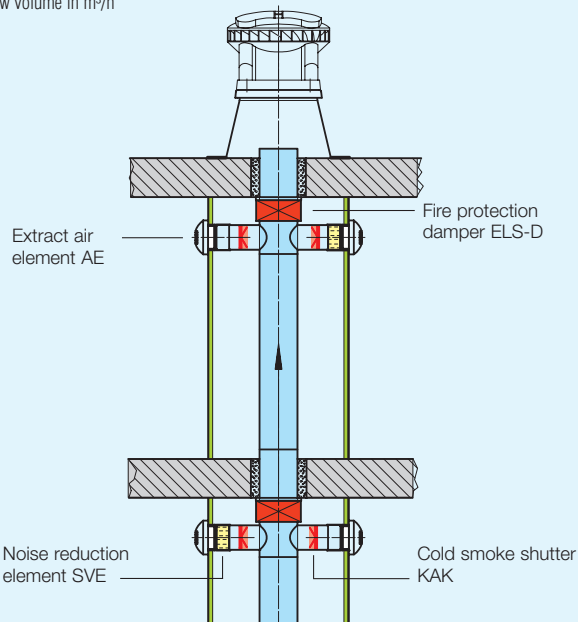

Acoustic data for extract air elements of series AE

The following sound levels are relevant for the extract air elements:
 – Sound power level for permanent air flow (L_w in dB (A))
 – Sound insulation between ducting system and ventilated room ($D_{n,e}$ in dB (A)).

This sound data is specified in the respective type table. They were measured according to the standard EN 13141.

The sound insulation value can be increased by using attenuator "AESE" or "AESE" (accessories), which is to be positioned and simply inserted behind the extract air element.

Cross talk attenuators are available for further noise reduction (p. 505).

Operation

Extract air elements with self adjusting constant air flow volume controllers are the ideal components for extraction in kitchens, bathrooms and toilets for central ventilation systems in houses.

Advantages

- Constant air flow volume between 40 and 160 Pa.
- No need for adjustment or balancing of the system.
- Attractive design.
- High quality construction in an aerodynamic shape with low sound levels.
- The cover and optimised height of the inlet nozzle offer an airtight seal against the wall.
- Easy cleaning without a risk of air flow volume change.

Design

Extract air element with mounting ring, ready to install, made of white polymer to be inserted in ducts with a nominal diameter of 125 mm. A rubber seal on the mounting ring to avoid leakage. As a result, the discolouration of decor is minimised.

Function

Ensures constant air flow volume under different pressure conditions between 40 and 160 Pa.

Delivery

Supplied as one element incl. mounting ring in separate poly bag.

Accessories

- Attenuator AESE to be inserted behind the element (Ref. no. 2059)
- Adapter filter element VFE 70 (Ref. no. 2552).

AE

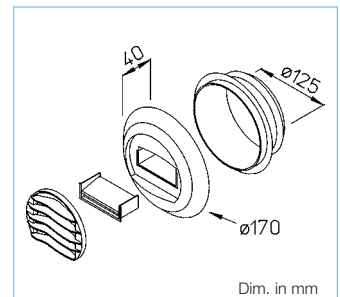

Dim. in mm

Installation

Suitable for wall and ceiling installation. The mounting ring, to be fixed via screws on duct or wall openings and the extract air element to be inserted. For an equal inlet and outlet air flow a straight duct of at least 300 mm is required.

Air flow volume performance curve AE

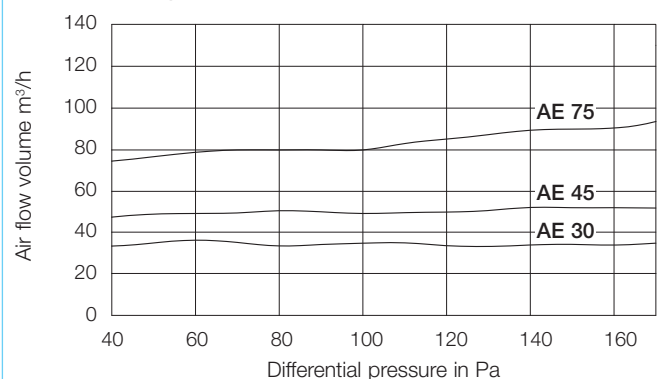

Type	Ref. no.	Sound power level L_w in dB (A)			Sound insulation $D_{n,e}$ in dB (A)	
		100 Pa	130 Pa	160 Pa	without AESE	with AESE
AE 30*	2030	30	33	36	60	64 ¹⁾
AE 45*	2031	33	34	37	56	63 ¹⁾
AE 75*	2033	35	36	39	57	64 ¹⁾

¹⁾ Equipped with attenuator AESE (accessories) * Air flow volume in m³/h

Operation

Extract air elements for two air flow volumes (basic and boost) with self adjusting constant air flow volume controller are the ideal components for extraction in kitchens, bathrooms and toilets for central ventilation systems in houses.

Advantages

- Two air flow volumes for standard and demand-based ventilation.
- Constant air flow volume between 40 and 160 Pa.
- No need for adjustment or balancing of the system.
- Attractive design.
- High quality construction in an aerodynamic shape with low sound levels.
- The cover and optimised height of the inlet nozzle offer an airtight seal against the wall.
- Easy cleaning without a risk of air flow volume change.

Function AE GB

The self adjusting air flow volume limiter keeps the adjusted nominal air flow volume (between 40 and 160 Pa) constant (see performance curve). Two control steps allow for standard and demand-based ventilation. On/off switching of high air flow volumes manually via pull cord.

Design (AE GB, AE GBE)

Extract air element with mounting ring, ready to install, made of white polymer to be inserted in ducts with nominal diameter of 125 mm. The rubber seal on the mounting ring avoids leakage of air. As a result, dis-colouration of the decor is minimised.

AE GB

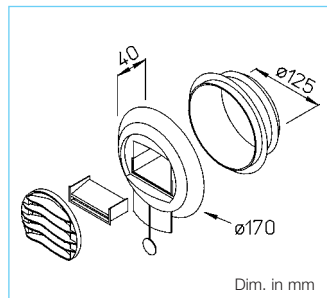

AE GBE

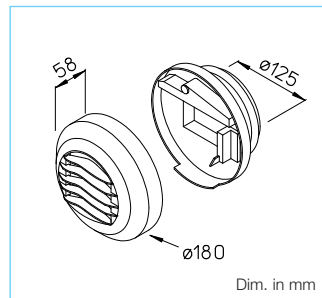

Operation

Extract air device with electric timer for two air flow volumes (standard and demand-based ventilation). Ideal components for extraction in kitchens, bathrooms and toilets for central ventilation systems in houses.

Advantages

- Two air flow volumes for standard and demand-based ventilation e.g. via on-site switch.
- No need for adjustment or balancing of the system.
- Attractive design.
- High quality construction in an aerodynamic shape with low sound levels.
- The cover and optimised height of the inlet nozzle offer an airtight seal against the wall.
- Easy cleaning without a risk of air flow volume change.

Function AE GBE

The basic air flow is increased to the higher level of air flow via a switch on-site (by others). After 30 minutes – regardless of the position of the switch on-site – it automatically returns to “standard ventilation”. 230 V, AC 0.5/3 W, IP X1

Installation (AE GB, AE GBE)

AE GB for wall, AE GBE also suitable for ceiling installation. The mounting ring, to be fixed via screws on duct or wall openings and the extract air element to be inserted. For an equal inlet and outlet air flow a straight duct of at least 300 mm is required.

Accessories

- Attenuator:
AE GB: AESD, Ref. no. 2059
AE GBE: AESE, Ref. no. 2058
- Adapter filter element
AE GBE: VFE 90, Ref. no. 2553 obstructs grease and dust deposits on extract air elements and in ducting.

Delivery

Supplied as one element incl. mounting ring in separate Polybag.

Upon request

Type AE FV 125 Extract air element filter and air flow volume adjustment, Ref. no. 9478

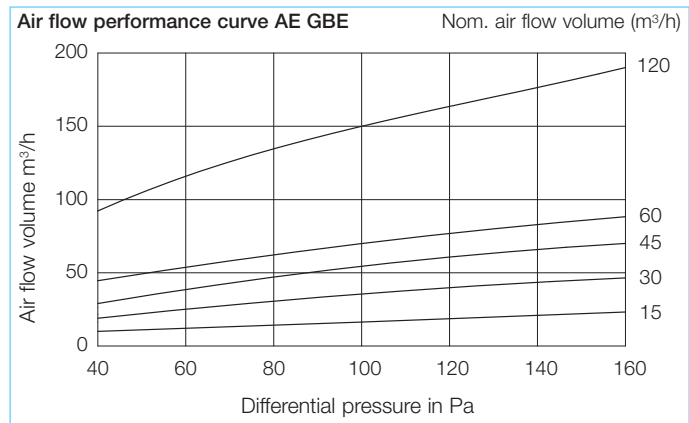
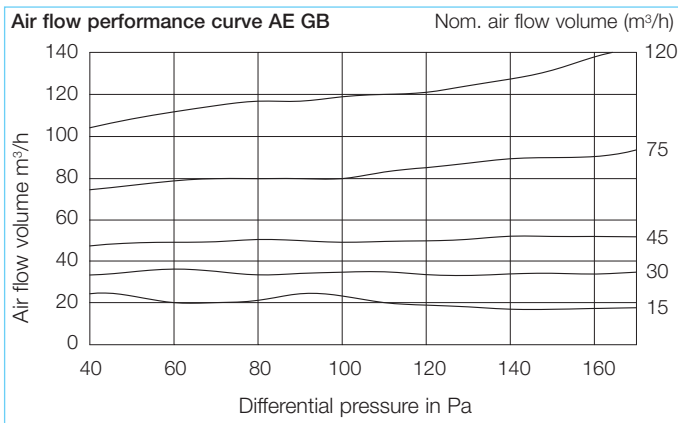

Ordering data		Sound power level ²⁾ L _w in dB (A)			Sound insulation D _{n,e} in dB (A)	
Type	Ref. no.	100 Pa	130 Pa	160 Pa	without AESD	with AESD
AE GB 15/30*	2035	27	31	34	60	64 ¹⁾
AE GB 20/75*	2036	27	30	33	57	64 ¹⁾
AE GB 45/120*	2038	33	34	37	56	63 ¹⁾

¹⁾ Equipped with attenuator AESD (accessories) ²⁾ Values are valid for standard ventilation
* Air flow volume in m³/h

Ordering data		Sound power level ²⁾ L _w in dB (A)			Sound insulation D _{n,e} in dB (A)	
Type	Ref. no.	100 Pa	130 Pa	160 Pa	without AESD	with AESD
AE GBE 15/30*	2044	30	33	36	60	64 ¹⁾
AE GBE 30/60*	2047	27	30	33	57	64 ¹⁾
AE GBE 45/120*	2048	29	32	35	57	62 ¹⁾

¹⁾ Equipped with attenuator AESE (accessories) ²⁾ Values are valid for standard ventilation

Operation

Extract air device with motion sensor and timer for two air flows (standard and demand-based ventilation). Ideal for extraction in kitchens, bathrooms and toilets for central ventilation systems in houses.

Advantages

- Two air flow volumes for standard and demand-based ventilation via integrated motion sensor.
- No need for adjustment or balancing of the system.
- Attractive design.
- High quality construction in an aerodynamic shape with low sound levels.
- The cover and optimised height of the inlet nozzle offer an air-tight seal against the wall.
- Easy cleaning without a risk of air flow volume change.

Design

Extract air element with mounting ring, ready to install, made of white polymer to be inserted in ducts with nominal diameter of 125 mm. The rubber seal on the mounting ring avoids air leakage. As a result, discolouration of the decor is minimised.

Function AE B

The basic air flow is to be increased to on demand air flow via an integrated motion sensor. After 30 minutes it automatically returns to "standard ventilation". Electrical supply through three batteries (on site, model LR 03, 1.5 V, operational life span approx. 18 months.).

AE B – with motion sensor

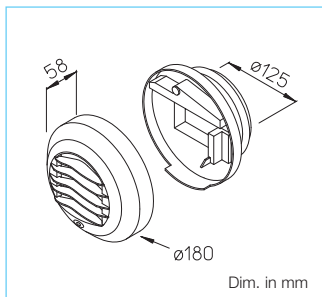

■ **Delivery and installation**
See description Type AE GB.

Accessories

- Attenuator AESE to be inserted behind the element (Ref. no. 2058).

AE Hygro – humidity controlled

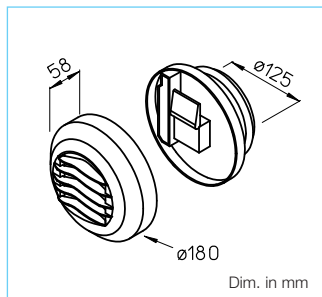

■ **Design, delivery and installation**
See description Type AE GB.

Accessories

- Attenuator AESE to be inserted behind the element (Ref. no. 2058).
- Adapter filter element VFE 90 for installation in front of the element (Ref. no. 2553).

Operation

The humidity controlled extract air elements allow a variable air flow volume depending on the relative humidity. They are suitable for the operation control of extract air volumes in bathroom and kitchen for ventilation systems in houses.

Advantages

- Automatically controlled air flow volume depending on the relative humidity between minimum and maximum limits.
- No need for adjustment or balancing of the system.
- Attractive design.
- High quality construction in an aerodynamic shape with low sound levels.
- The cover and optimised height of the inlet nozzle offer an air-tight seal against the wall.
- Easy cleaning without a risk of air flow volume change.

Function AE Hygro

The air flow volume is automatically controlled depending on the relative humidity between minimum and maximum limits. Achieving the defined trickle air flow at Δp of 80 Pa depending on the relative humidity. No need for electric connection.

Additional function AE Hygro GBE

The basic air flow is increased to the higher level of air flow via a switch on-site (by others). After 30 minutes – regardless of the position of the switch on-site – it automatically returns to "standard ventilation".

230 V, AC 0.5/3 W, IP X1

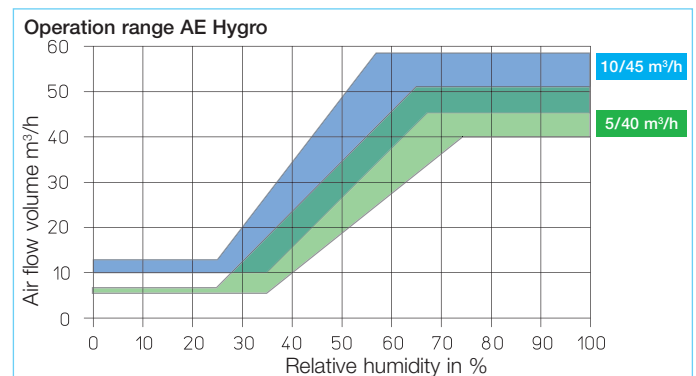
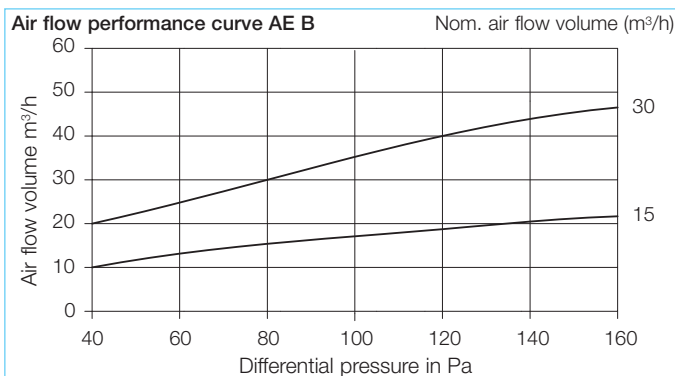

Ordering data		Sound power level ²⁾ L _w in dB (A)			Sound insulation D _{n,e} in dB (A)	
Type	Ref. no.	100 Pa	130 Pa	160 Pa	without AESE	with AESE
AE B 15/30*	2055	20	25	28	60	64 ¹⁾

¹⁾ Equipped with attenuator AESE (accessories) ²⁾ Values are valid for standard ventilation

Ordering data		Sound power level ²⁾ L _w in dB (A)			Sound insulation D _{n,e} in dB (A)	
Type	Ref. no.	100 Pa	130 Pa	160 Pa	without AESE	with AESE
AE Hygro 10/45*	2049	29	32	35	57	61 ¹⁾
AE Hygro GBE 5/40/75 ³⁾ *	2053	28	31	34	56	64 ¹⁾
AE Hygro GBE 10/45/120 ³⁾ *	2054	29	32	35	56	62 ¹⁾

¹⁾ Equipped with attenuator AESE (accessories)

²⁾ Values for standard ventilation

³⁾ For the performance curve of on demand ventilation see AE GBE left page * Air flow vol. in m³/h

ABV 100

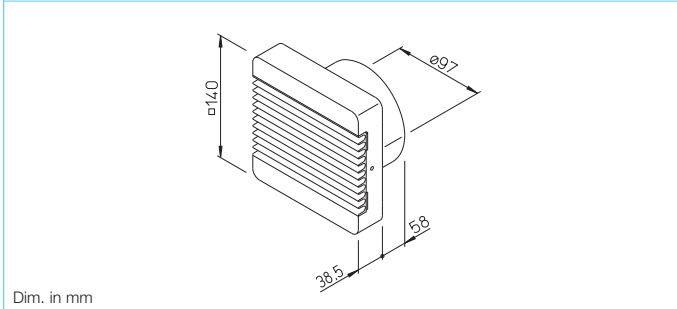

Dim. in mm

VFE

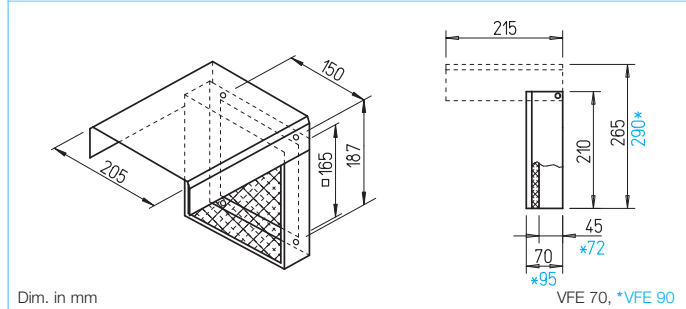

Dim. in mm

VFE 70, *VFE 90

AbluVent ABV 100

Can be used in central ventilation systems in accordance with DIN 18017-3 with variable air flow volumes. Demand-regulated ventilation, e.g. for bathrooms and toilets without windows. All elements in the system must have the same design. Made of high quality polymer, colour: White.

Function

AbluVent is operated via a light switch. The louvres open when the room is in use. Standard ventilation is provided when the room is not in use, a low air flow is extracted when the louvres are closed.

Advantages

- Energy saving.
- Low cost.
- Quick installation.
- Always an optimum solution.
- Delayed closure of approx. 5 minutes.
- Stepless adjustment of air flow volume.
- Noiseless operation.
- Changeable filter to keep duct system clean.

Air flow volume

The opening pitch of the louvres can be set stepless between 15 – 80 degrees (covered, inside fascia panel).

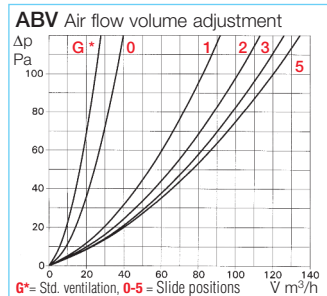

The diagram above shows the air flow in relation to the setting and negative pressure.

Technical data – connection

The unit is operated by a standard on/off switch, ideally combined with a light switch. Supply voltage: ~220/240 V, 3 W. Double insulated, interference-free, protected to IP 44. Casing: polymer, alpine white. The thermal metal shutter works with a short delay opening (approx. 30 sec.) and closing of (approx. 5 min.).

Type ABV 100 Ref. no. 0452

Accessories

Type ELF/ABV Ref. no. 6906
Spare filter mats.
Contents = 5 pcs.

Adapter filter element VFE

Simple and cost effective solution for filtering greasy, contaminated room air. To be installed in front of extract air elements or poppet valves.

Operation

Filter element to cover air vents and prevent dirt deposits from poppet valves, extract air elements and connected ducting. Ideal for use in the kitchen with a central ventilation system in line with DIN 18017.

Advantages

- Prevents grease and dust deposits from extract air elements or poppet valves and connected ducting.
- Filter replacement in a few easy steps.
- The permanent filter can be cleaned in a dishwasher.
- Discreet design in pleasant white.
- Simple installation via four screws.
- Hinders possible contamination areas.
- Less maintenance cost of ducting through longer cleaning periods

Casing

Robust casing made of galvanised sheet steel, white, powder coated polymer. The fascia panel is pivotable at 90° and prevents the view into the filter and contamination area.

Filter

Dimensionally stable aluminium filter fabric with 324 cm² free filter area and aluminium frame.

VFE Pressure loss clean condition

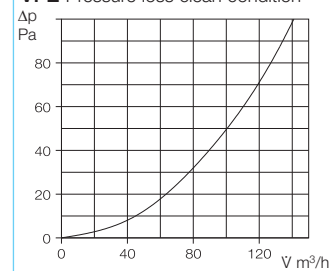

Installation

Suitable for wall and ceiling installation. Simply fixed with four screws. Elongated slot-fixing holes ensure easy positioning. To be fixed directly over the installed extract air element (max. outer Ø 175 mm). Fascia panel is hinged at 90°; for easy filter removal and a space between the upper edge of the casing and the ceiling (see drawing) is necessary.

Delivery

Each element including installation accessories is packed separately.

Delivery range

Type VFE 70 Ref. no. 2552

Suitable for extract air elements with max. 70 mm installation depth such as AE, MTVA, KTVA, BTV, BTK.

Type VFE 90 Ref. no. 2553

Suitable for extract air elements with max. 90 mm installation depth such as e.g. AE GBE, AE Hygro.

Accessories

Type ELF/VFE Ref. no. 2554

Spare air filter, suitable for the types VFE 70 and VFE 90. Contents = 2 pcs.

ETS



Surprisingly simple and cost effective solution to reduce noise transmission in central ventilation systems. Easy installation direct into ducting behind the air valve.

Advantages

- Optimum solution for the prevention of noise transmission in ventilation ducting.
- Excellent attenuation figures (see diagram).
- Simple installation by inserting into duct behind the air valve.
- Virtually no additional resistance to the system, as the resistance value is below the setting value of the valve.
- Minimising system costs by using cost effective ducting.
- Can be used with any brand of valves.

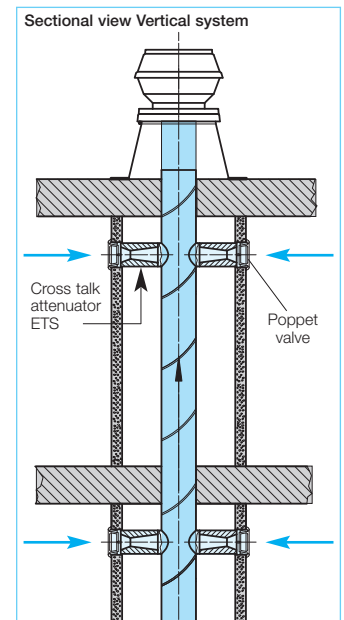
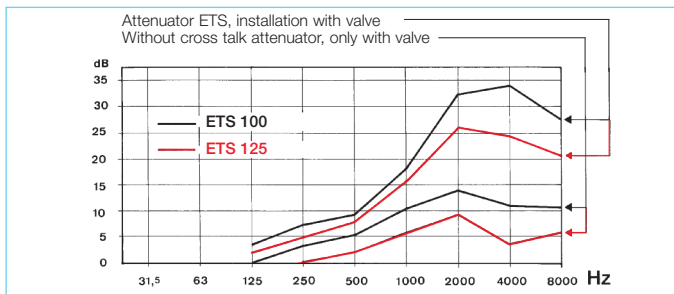
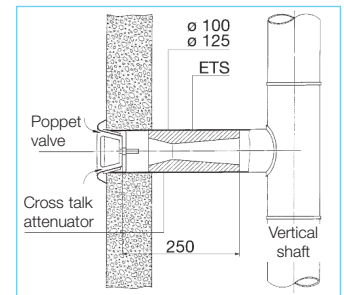
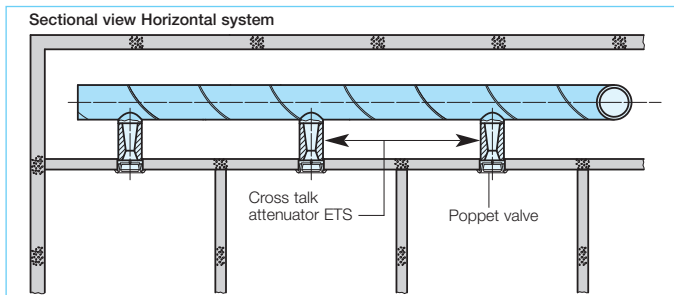

Delivery range

Type ETS 100 Ref. no. 4521
Nominal duct Ø 100 mm

Type ETS 125 Ref. no. 4522
Nominal duct Ø 125 mm

Attenuation figure

The attenuation figure can be doubled if you have two facing rooms where both have an ETS attenuator in the ducting.

Material

Flexible polyurethane foam with improved reaction in case of fire, complies with DIN 4102, class B1, UL-94-HF 1, MVSS 302 among others.



■ Operation

For supply air operation in all rooms without special fire protection requirements. Ideal for wall installation close to the ceiling with the air flow directed into the room.

■ Advantages

- Elegant, square casing made from high-quality polymer.
- Air cone evenly streams to the centre of the room.
- Includes mechanically adjustable volume controller for adjusting the ventilation system. Accessible by removing the casing, with location markers (stages 0 – 9, see diagram).
- Casing can be removed without tools for the simple cleaning of the air-exposed valve parts.
- Sealing ring on spigot for precise positioning and sealing in the ducting, prevents discolouration of the wall.
- Fixing holes in casing base for secure fixation.

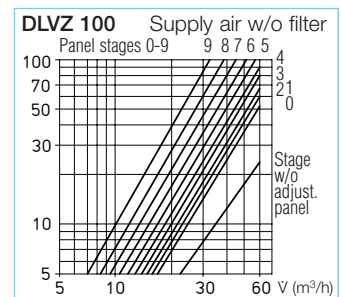
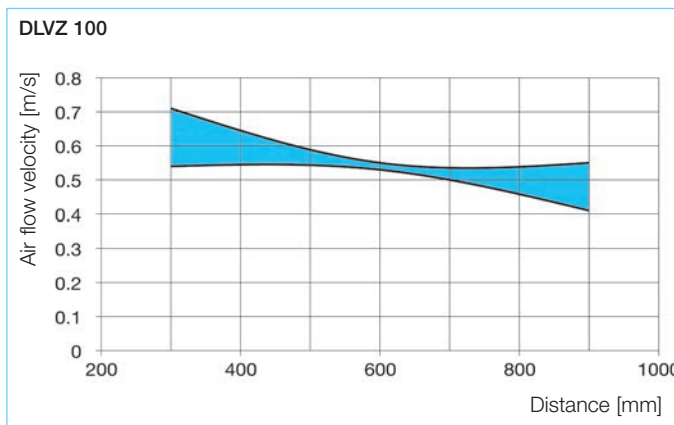

■ Design

Casing design made from white, impact-resistant polymer.

■ Delivery

Valves individually packaged in polybag, including setting control (mountable if necessary) as well as installation and operating instructions.

■ Installation

- Mount volume controller if necessary. Pre-set air volume according to diagram.
- Position casing base in ventilation duct and fix to the wall.

- When adjusting the entire system, adjust any air volume settings.
- Upper part of casing attachable without tools.

■ Performance data

The diagrams provide an overview of the air volumes and pressure losses for different volume controller settings, as well as the flow velocity of the out-flowing air at 30 m³/h in relation to the valve distance.

Ordering data	
Type	DLVZ 100
Ref. no.	3040
Dimensions in mm	
∅ C	100
A	135
B	135
D	20
Weight in g	150

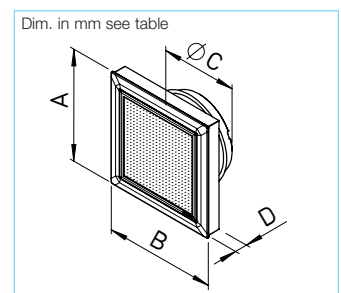

DLV



reddot
design
award
winner
2008



Designpreis
Deutschland
2010
NOMINIERT



product
design
award
2008



Focus Green
Silber 2008

Operation

For supply and extract air operation in all rooms without special fire protection requirements. Ideal for ceiling installation.

Advantages

- Elegant, square casing made from high-quality polymer with covered air intake and discharge area.
- Precise air volume adjustment by turning the elegant front panel in 90° stages, with location markers for adjusting the ventilation system.
- Integrated filter exchangeable without tools and without risk of changing the setting.
- Selected air volume setting can be locked.
- Minimum air volume also ensured for fully closed air volume setting. Full closure only by nur irreversibly removing the minimum air volume stop.
- Front panel can be removed without tools, with adjustment mechanism and filter holder for the simple cleaning of the air-exposed valve parts.
- Sealing ring on spigot for precise positioning and sealing in the ducting.
- Fixing holes in casing base for secure fixation to the ceiling.

Accessories

Replacement air filter class G2
Contents: 5 pcs.

Type ELF-DLV 100 No. 3042

Type ELF-DLV 125 No. 3058

DLV 100 – DLV 125

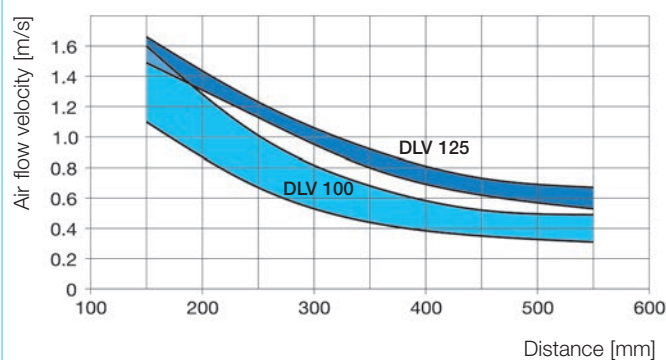

Design

Casing design made from white, impact-resistant polymer. Elegant square appearance with closed front panel.

Delivery

Valves individually packaged in polybag, including G2 filter, installation and operating instructions.

Installation

- Place G2 filter in the filter holder.
- Pre-set air volume according to diagram.
- Position casing base in ventilation duct and fix to the ceiling.

- When adjusting the entire system, adjust any air volume settings.
- Front panel with adjustment mechanism and filter holder can be attached without tools.

Performance data

The diagrams provide an overview of the air volumes and pressure losses for different front panel settings, as well as the flow velocity of the outflowing air at 30 m³/h (DLV 100) or 60 m³/h (DLV 125) in relation to the valve distance.

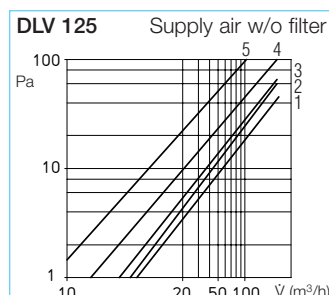
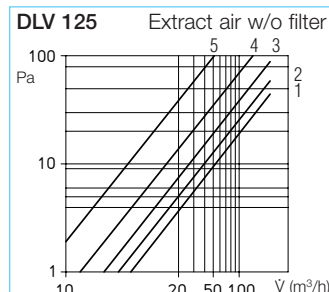
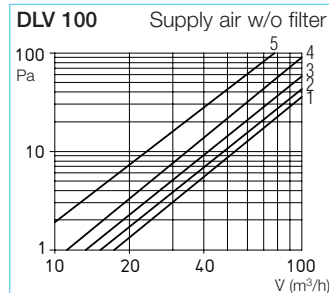
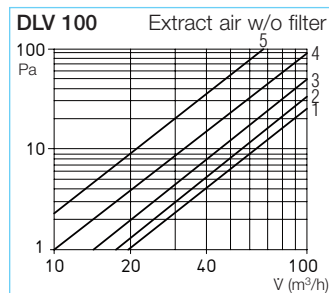

Ordering data

Type	DLV 100	DLV 125
Ref. no.	3039	3049
Dimensions in mm		
Ø C	100	125
A	135	176.5
B	135	176.5
D	10-30	15-30
Weight in g	150	210

Dim. in mm see table

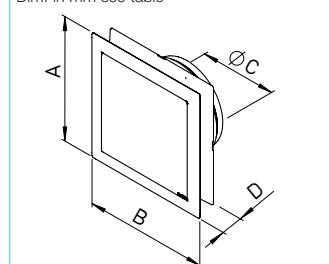

MTVA



■ Operation

For air extract in any room especially where ventilation system components of non flammable materials are required. Suitable for low and high air flow speed. Low noise characteristic.

■ Advantages

- Technically advanced design, aerodynamically shaped for low sound levels.
- Large cover with optimised height of the inlet ring avoids marking of decor.
- Quick mounting in ceiling and wall without tools.
- Plaster and difference compensation for unevenness, differences in diameter or ducting that has been too deeply plastered.
- Spring mounting clamp offers a direct insertion in ducts or walls up to approx. 20 mm size without an additional mounting ring.

■ Design

Metal construction protected against corrosion by a high quality epoxy paint in white. The foam strip fitted around the valve provides an air tight connection avoiding air leakage and dis-colouration around the valve.

■ Delivery

Each valve is separately supplied in polybag.

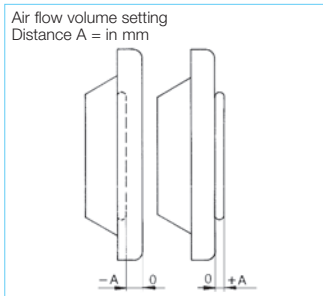

■ Accessories

For installation in ducting, walls or thin panels, a mounting ring may be required (see table).

■ Installation

Set valve to required air flow volume according to the diagram. The distance 'A' is given in mm from the 0 point. Then simply press valve into wall or ducting.

■ Performance data

These diagrams show the relationship between air flow volumes, resistances and sound levels at various adjustments of the distance "A" in mm.

MTVA 125

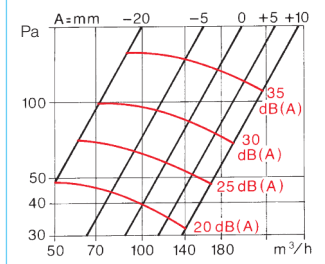

MTVA 75/80

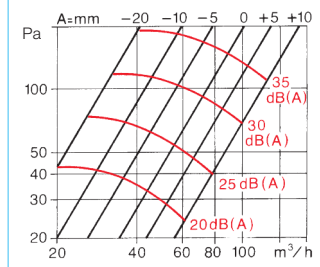

MTVA 160

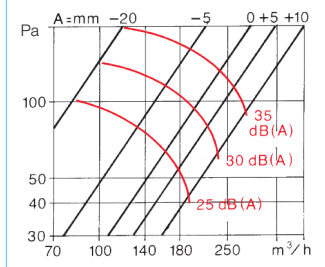

MTVA 100

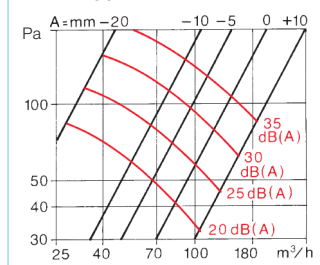

MTVA 200

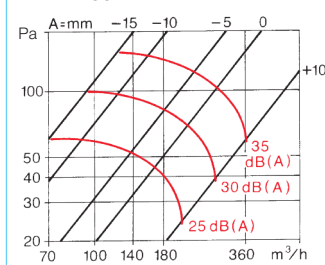

Ordering data					
Type	MTVA 75/80	MTVA 100	MTVA 125	MTVA 160	MTVA 200
Ref. no.	8868	8869	8870	8871	8872
Dim. in mm					
Ø A	73 – 85	95 – 105	120 – 130	150 – 165	195 – 205
Ø B	108	135	160	195	230
C	15	15	15	15	18
D	58	59	60	58	63
Weight in g	150	190	255	340	450
Mounting ring					
Type	EBR 75/80	EBR 100	EBR 125	EBR 160	EBR 200
Ref. no.	0952	0953	0954	0955	0956
for DN (mm)	75/80	100	125	150/160	200

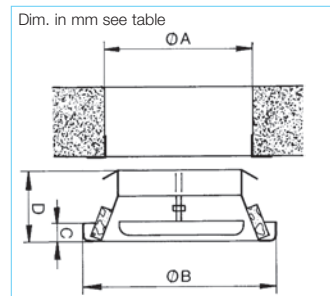

KTVA



■ Operation

For air extraction with high and low air flow speeds or resistances.
For all rooms without special fire protection requirements.

■ Advantages

- Installation without tools in seconds.
- High noise attenuation through built-in attenuator in fan.
- High quality anti static polymers suitable for temperatures up to +100 °C.
- Using a mounting ring avoids dis-colouration of surrounding decor.
- Plaster and difference compensation for unevenness, differences in diameter or ducting that has been too deeply plastered.
- Spring fit connector allows direct installation in ducting or wall with a minimum thickness of approx. 20 mm without an additional mounting ring.

■ Design

Aerodynamically shaped made from impact resistant white polymers. Adjustable air flow via rotating valve plate (volume throughput see diagram).

■ Delivery

Each valve is individually supplied in polybag.

■ Accessories

For installation in ducting, walls or thin panels, a mounting ring may be required (see table).

■ Installation

Set valve to required air flow volume according to the diagram through core revolutions then simply press valve into wall or ducting.

■ Performance data

These diagrams show the relationship between air flow volumes, resistances and sound levels at various core openings.

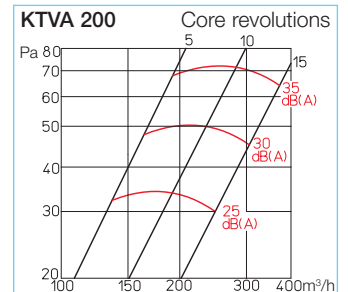
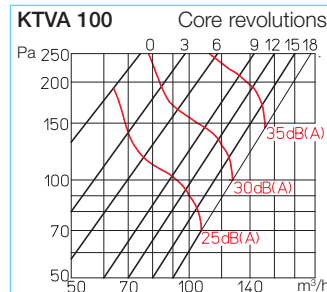
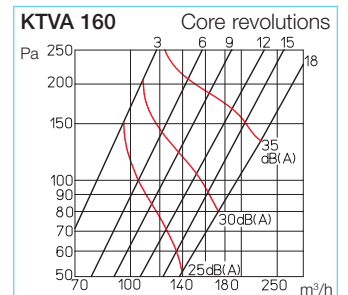
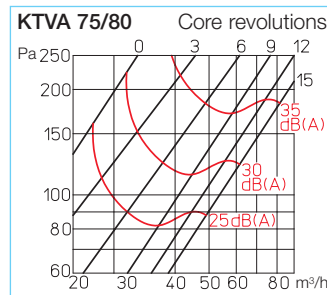
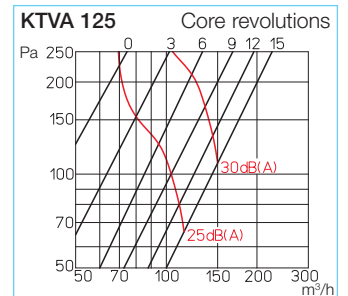

Ordering data					
Type	KTVA 75/80	KTVA 100	KTVA 125	KTVA 160	KTVA 200
Ref. no.	0940	0941	0942	0943	0944
Dim. in mm					
Ø A	73 – 85	95 – 105	120 – 130	150 – 165	195 – 210
Ø B	45	70	95	125	172
Ø C	120	145	160	195	240
D	35	35	35	35	35
Weight in g	90	115	150	200	340
Mounting ring					
Type	EBR 75/80	EBR 100	EBR 125	EBR 160	EBR 200
Ref. no.	0952	0953	0954	0955	0956
for DN (mm)	75/80	100	125	150/160	200

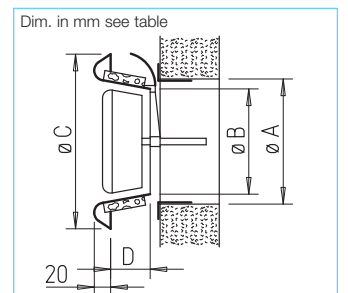



■ Operation

For air supply to any room especially where ventilation system components of non flammable materials are required. Suitable for low and high air flow speed. Low noise characteristic.

■ Advantages

- High-quality metal design, aerodynamically shaped for low sound levels.
- Large cover with optimised height of the inlet ring avoids marking of decor.
- Quick mounting in ceiling and wall without tools.
- Plaster and difference compensation for unevenness, differences in diameter or ducting that has been too deeply plastered.
- Spring mounting clamp offers a direct insertion in ducts or walls up to approx. 20 mm size without an additional mounting ring.

■ Design

Metal construction protected against corrosion by a high quality epoxy paint in white. The foam strip fitted around the valve provides an air tight connection and avoids air leakage and dis-colouration around the valve.

■ Delivery

Each valve is separately supplied in a polybag.

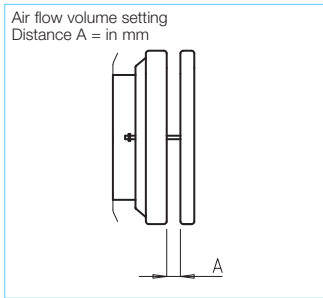

■ Accessories

For installation in ducting, walls or thin panels a mounting ring may be required (see table).

■ Installation

Set valve to required air flow volume according to the diagram. The distance 'A' is given in mm from the 0 point. Then simply press valve into wall or ducting. For an even air flow a straight duct of approximately 300 mm is required.

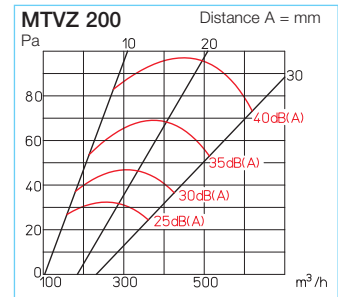
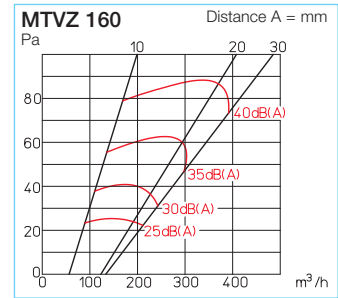
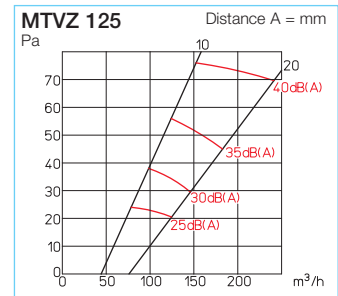
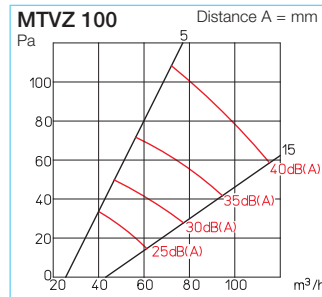
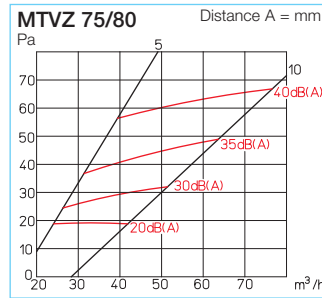

■ Performance data

These diagrams show the relationship between air flow volumes, resistances and sound levels at various adjustments of the distance "A" in mm.

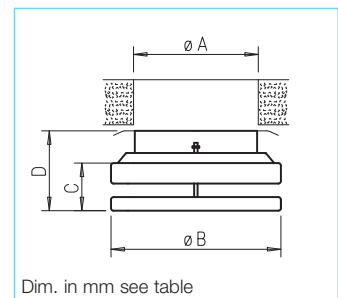

Ordering data					
Type	MTVZ 75/80	MTVZ 100	MTVZ 125	MTVZ 160	MTVZ 200
Ref. no.	9603	9604	9605	9606	9607
Dim. in mm					
Ø A	73 – 85	95 – 105	120 – 130	150 – 165	195 – 210
Ø B	108	135	160	195	230
C	26 – 46	26 – 46	26 – 46	26 – 56	26 – 56
D	68	70	70	68	73
Weight approx. g	190	240	300	390	480
Mounting ring					
Type	EBR 75/80	EBR 100	EBR 125	EBR 160	EBR 200
Ref. no.	0952	0953	0954	0955	0956
for DN (mm)	75/80	100	125	160	200

KTVZ



Fig.: Type KTVZ 100 – 200

■ Operation

For air extraction with high and low air flow speeds or resistances.
In all rooms without special fire protection requirements.

■ Advantages

- Installation without tools in seconds.
- Elegant valve plate covering the opening for stepless adjustment. Made from high-quality white polymer, suitable for temperatures up to +100 °C.
- Using a mounting ring avoids dis-colouration of surrounding decor.
- Plaster and difference compensation for unevenness, differences in diameter or ducting that has been too deeply plastered.
- Spring mounting clamp offers a direct insertion in ducts or walls up to approx. 20 mm size without an additional mounting ring.

■ Design

Made from impact resistant white polymers and aerodynamically shaped.
Adjustable air flow via rotating valve plate (volume throughput see diagram).

■ Delivery

Every valve is supplied separately in polybag.

■ Accessories

For installation in ducting, walls or thin panels a mounting ring may be required (see table).

■ Installation

Set valve to required air flow volume through corresponding number of core revolutions according to the diagram. Then simply press valve into wall or ducting. For an even air flow a straight duct of approximately 300 mm is required.

The air flow can be directed in a defined direction through the targeted sealing element, e.g. toward centre of room.

■ Performance data

These diagrams show the relationship between air flow volumes, resistances and sound levels at various core openings.

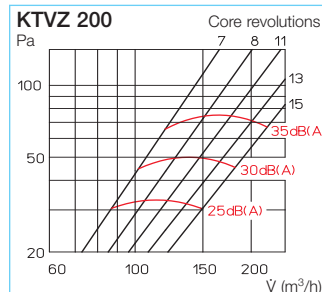
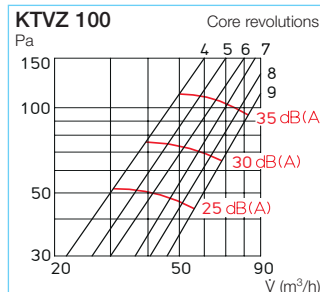
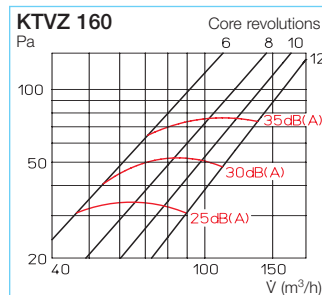
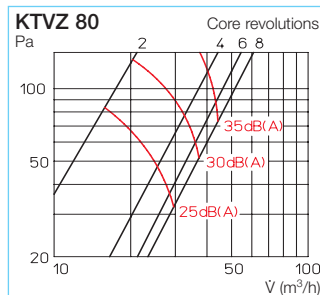
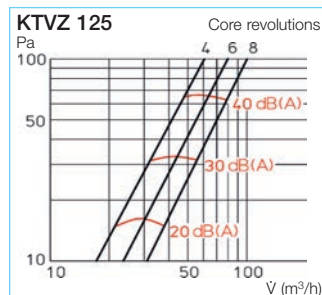

Ordering data					
Type	KTVZ 80	KTVZ 100	KTVZ 125	KTVZ 160	KTVZ 200
Ref. no.	2762	2736	2737	2738	2739
Dim. in mm					
Ø A	70 – 80	95 – 105	120 – 130	145 – 160	195 – 210
Ø B	80	138	170	195	235
Ø C	119	148	180	205	245
D	19,5	17	21	23	22
E	52	47	47	51	56
Weight approx. g	90	100	260	370	600
Mounting ring					
Type	EBR 75/80	EBR 100	EBR 125	EBR 160	EBR 200
Ref. no.	0952	0953	0954	0955	0956
for DN (mm)	75/80	100	125	150/160	200

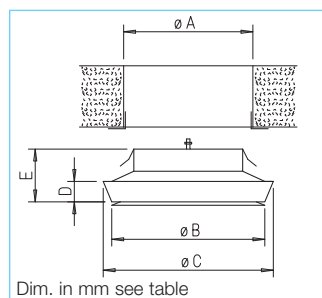

Dim. in mm see table

ZTV

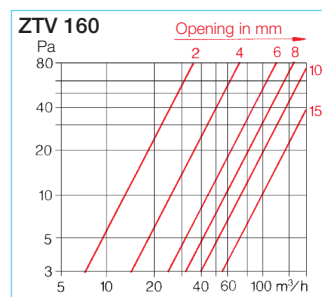
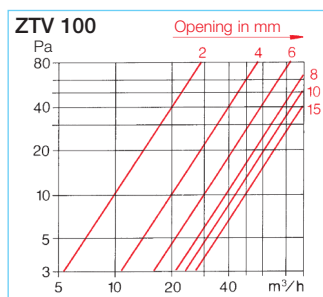
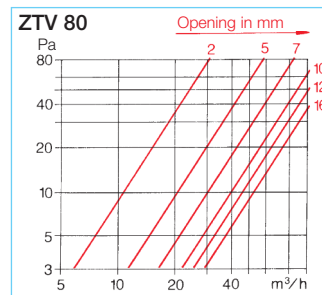

Special features – Operation
 Innovative thermostatic supply air valve for automatic temperature controlled replacement air. Efficiently combines energy savings and permanent ventilation. Permanent control of supply air flow volume with adjustable core for any type of room. Suitable for natural (thermal) and mechanical ventilation as supply air element.

Installation
 ZTV valves can be easily installed in existing supply air openings. They are fixed to ducting by push fit (with rubber gasket) or by three concealed fixing holes in the frame supplied with fixing screws.

Function
 The thermostat operates automatically within a temperature range of $-6\text{ }^{\circ}\text{C}$ to $+20\text{ }^{\circ}\text{C}$. Within this range air flow volumes between 0 and $30\text{ m}^3/\text{h}$ are achieved conforming to DIN guidelines. See performance diagrams on the right. In its standard setting the valve closes completely at outside air temperature of approx. $-4\text{ }^{\circ}\text{C}$. A minimum supply air rate is allowed by the 4 mm wide distance clip. The initial setting of the valve can be changed manually by rotating the centre core. One full rotation equals to a variance of 4 mm gap (see blue marked areas in diagram).

- Advantages**
- Fully automatic, demand-regulated air flow control.
 - Maintenance free, no running cost.
 - Individual air flow volume adjustment by rotating the valve plate.
 - Good sound insulation due to the attenuator built into the valve plate.
 - Attractive, functional design.
 - Wide intake ring reduces wall discolouration.
 - Quick and easy installation.

Design
 The Helios supply air thermostat valves are made of impact resistant, white polymer. Aerodynamically shaped and an attractive design. Insulated coating on inner side of the valve plate to prevent condensation.

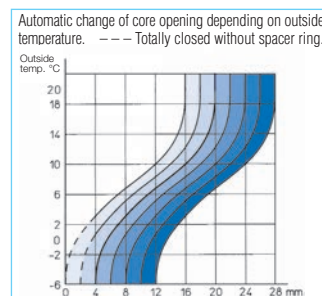
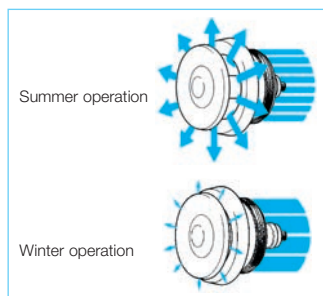

Number of units
 The number of supply air elements necessary is to be defined according to DIN 1946, T.6 depending on the apartment size and wind force (see chart on the right).

Number of units with mechanical demand-based ventilation			
Apartment size m ²	Number of ZLA / ZLE		Fans
	Extract air (8 Pa)*	Supply air (4 Pa)*	Number/Unit
Hotel room 25 m ²	2	-	1
Apartment 25 m ²	2 (3) **	-	1
Flat I 50 m ²	2	3 - 4	2
II > 50, < 80 m ²	3	4	2
III > 80 m ²	4	5	3
House up to 120 m ²	4	5	3

* according to DIN 1946, T.6 tab. 10 ** if a kitchenette is also to be extracted

Ordering data			
Type	ZTV 80	ZTV 100	ZTV 160
Ref. no.	0078	0073	0074
Dim. in mm			
∅ A = Duct nominal size	80	100	160
∅ B	77	95	156
∅ C	147	147	207
D	77	77	77
E	49	49	50
Weight approx. g	230	240	370

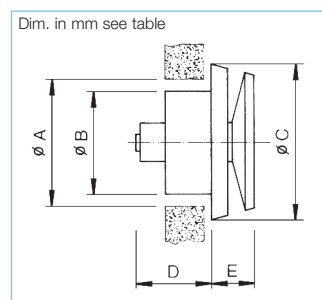

ZLA

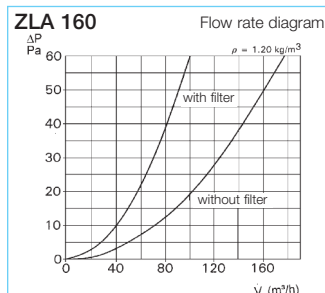
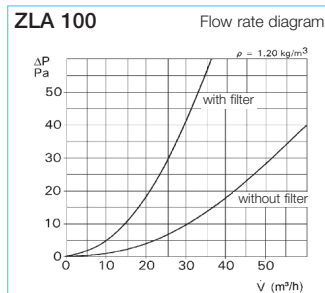
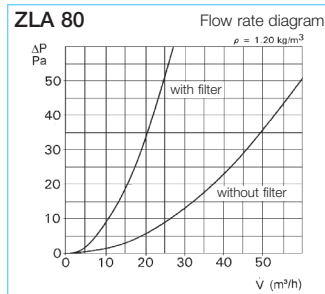
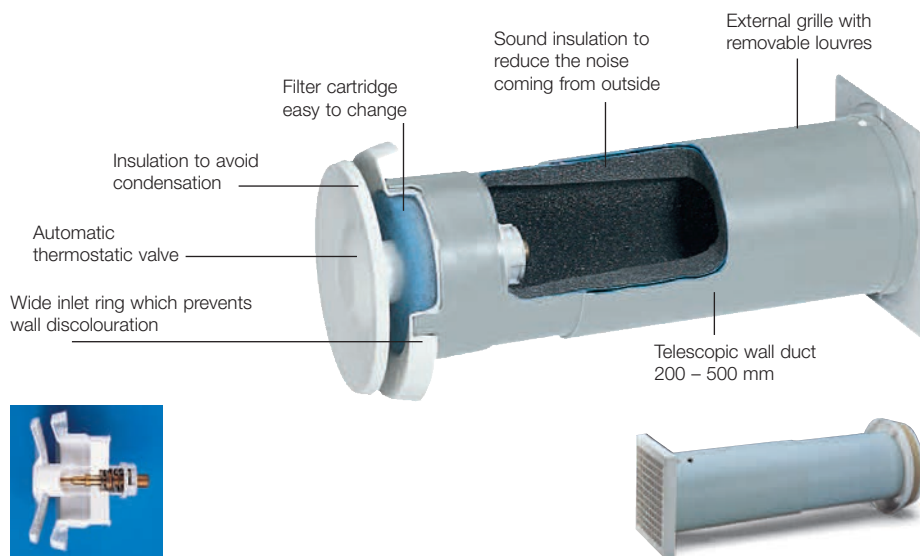

Special features – Operation

Universally adaptable temperature controlled supply air unit. The energy saving, thermostatic supply valve provides a continuous air exchange at highest efficiency. The supply air volume is controlled depending on the outside air temperature, without any electrical connection. The supply air is evenly distributed, filtered (class G 3) and attenuated.

Advantages

- Fully automatic, on demand air flow control.
- Maintenance free, no running cost.
- Individual air flow volume adjustment by rotating the central core.
- Telescopic wall duct, made of polymer for wall thicknesses between 200 to 500 mm.
- High sound insulation via the built-in attenuator.
- Easily removable filter.
- No electrical supply required.
- Quick and easy installation.

Function

The thermostat operates automatically within a temperature range of $-6 \text{ }^\circ\text{C}$ to $+20 \text{ }^\circ\text{C}$. Within this range air flow volumes between 0 and 30 m³/h are achieved conforming to DIN guidelines. See performance diagrams on the right. In its standard setting the valve closes completely at outside air temperature of approx. $-4 \text{ }^\circ\text{C}$. A minimum supply air rate is allowed by the 4 mm wide distance clip. The initial setting of the valve can be changed manually by rotating the centre core. One full rotation equals to a variance of 4 mm gap (see blue marked areas in diagram).

Installation

Suitable for wall or ceiling openings. Telescopic duct should be inserted from outside and the cover grille should be screwed on. Duct to be cleaned and the valve to be inserted from inside.

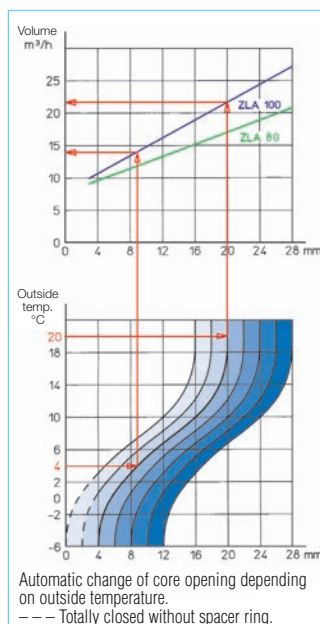

Note

The number of supply air units is to be defined according to DIN 1946, T.6 (see chart on the left page).

Performance data

The air flow volume depending on pressure difference is determined by the opening gap of the valve plate. The performance values can be seen from the diagrams above.

Accessories

Spare filters class G 3
Contents: 10 pcs.

Type ELFZ 80 Ref. no. 0339

Type ELFZ 100 Ref. no. 0340

Type ELFZ 160 Ref. no. 0341

Ordering data

Type	ZLA 80	ZLA 100	ZLA 160
Ref. no.	0214	0215	0216
Volume max. with filter m ³ /h	25	35	100
Duct nominal size (mm)	80	100	160
Wall penetration \varnothing mm	96	115	175
$\varnothing A$ mm	147	147	207
B mm	49	49	50
C mm	260–500	260–500	260–500
D mm	107	140	190
E mm	3	15	24
Weight approx. kg	0,7	0,8	1,6
Sound insulation value $D_{n,e}$ 30 to 35 dB (depending on installation or wall thickness; corresponds to double glazing acc. to VDI 2719 protection class 2 or 3).			

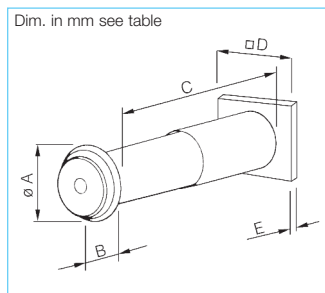

ZLE

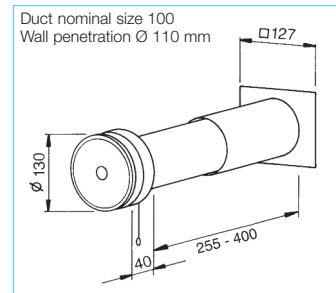
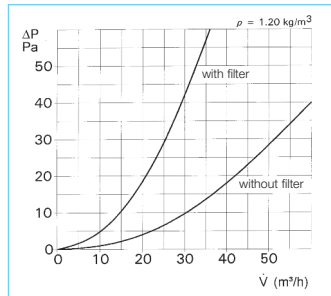

Special features – Operation

Manually operated supply air element for any kind of room. The air flow volume can be adjusted through a four step ratchet mechanism using a pull cord. The supply air is evenly distributed, filtered (class G 3) and attenuated.

Advantages

- Permanent intake air reduces draughts.
- Adjustable air volume controlled by adjusting the valve plate.
- Simple control via pull cord.
- No electrical supply required.
- Wide intake ring reduces wall discolouration.
- Telescopic wall duct, made of polymer for wall thicknesses between 255 to 400 mm.
- Good sound insulation with the built-in attenuator.
- Easily removable filter.
- Quick and easy installation.

Installation

Simple installation in wall openings. Insert the telescopic duct from outside, adjust to thickness of wall and render. Push in rain repellent grille from outside, snap lock fixing or can be screwed with masonry plugs. Insert valve from inside. If placed near radiators the supply air is preheated during the cooler periods. Ensure that valve is accessible for filter change.

Design

ZLE comes as a complete unit including:

Valve

Attractive, unobtrusive design made of high quality white polymer. Incorporating a pull cord for three core positions. Insulated coat on inner valve to prevent condensation.

Telescopic wall duct

Two liners, made of impact resistant polymer.

Attenuator

To reduce air sound levels from outside.

Air filter

For clean and dust free air supply (class G 3), replaceable.

Outside wall grille

Fixed, rain repellent, made of UV-stable polymer in white.

Filter change

Easy, without any tool kit. Can be maintained by removing the valve.

Performance data

The air flow volume depending on pressure difference is determined by the opening gap of the valve plate. The performance figures are shown in the diagram above. Sound insulation rate: $D_{n,e}$: 30–35 dB (depending on installation and wall thickness; comparable with double glazing class 2 or 3).

Number of units

The number of required supply air elements is to be defined according to DIN 1946, T.6 independant to the apartment size and wind force (see the following chart).

Type ZLE 100 Ref. no. 0079

Number of units with mechanical demand-based ventilation				
	Apartment size m ²	Number of ZLA / ZLE		Fans
		Extract air (8 Pa)*	Supply air (4 Pa)*	Number/Unit
Hotel room	25 m ²	2	–	1
Apartment	25 m ²	2 (3) **	–	1
Flat	I 50 m ²	2	3 – 4	2
	II > 50, < 80 m ²	3	4	2
	III > 80 m ²	4	5	3
House	up to 120 m ²	4	5	3

* according to DIN 1946, T.6 tab. 10 ** if a kitchenette is also to be extracted

Accessories

Spare filter class G 3

Type ELF/ZLE 100 Ref. no. 0338

Contents = 10 pcs.

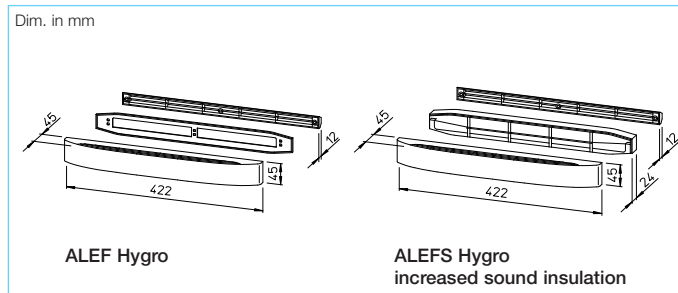
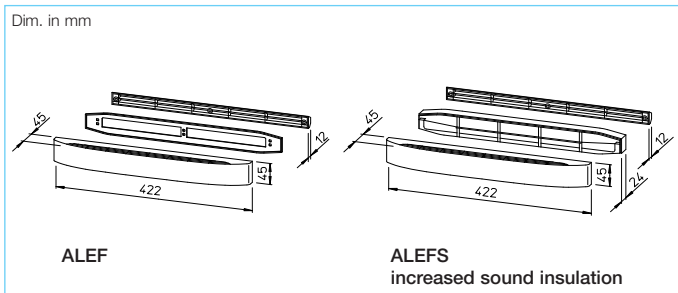

Air flow volume elements ALEF with air flow volume control / limitation, to install in window frames / casements.

Operation

The window element flow is directly related to the differential pressure and supplies the outside air to living rooms and bedrooms. Simple installation, is also suitable for retro-fitting.

Design

Ready-to-install unit, contains inner facade with an automatic air flow volume delimiter, installation plate and cover strip. All parts are made of high quality, white polymer. The models ALEFS have an acoustic element for an increased sound insulation.

Function

Due to the negative pressure of extract air in the kitchen, bathroom and toilet, the element allows a certain amount of air flow volume to enter in the living / bedrooms from outside (see diagram).

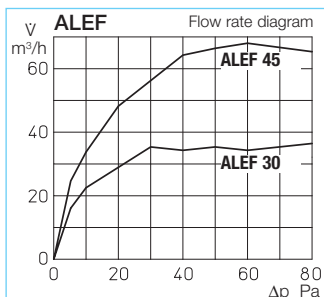

Humidity controlled air flow volume elements ALEF Hygro with air flow volume control / limitation to install in window frames / casements.

Operation

Window elements that allow a controlled air flow volume, dependent on the humidity level in the room, to enter in the living / bedrooms.

Ideal in combination with humidity controlled extract fans. Simple installation, is also suitable for retro-fitting.

Design

Ready-to-install unit, contains inner facade with an automatic air flow volume delimiter, installation plate and cover strip. All parts are made of high quality, white polymer. The models ALEFS Hygro have an acoustic element for an increased sound insulation.

Function

Due to the negative pressure of extract air in the kitchen, bathroom and toilet, the element allows a certain amount of air flow volume, which depends on the humidity level in the room, to enter in the living / bedrooms from outside (see diagram).

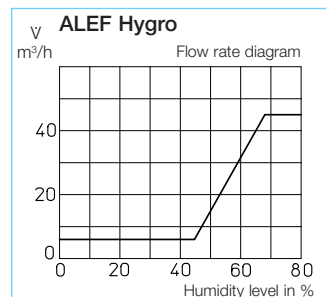

Installation

In wooden, polymer and metal window frames. Openings by means of milling groups or holes in the upper frame. Simply screw the cover strip to the installation plate and clip the inner facade on.

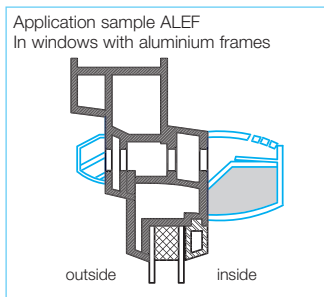

Installation

In wooden, polymer and metal window frames. Openings by means of milling groups or holes in the upper frame. Simply screw the cover strip to the installation plate and clip the inner facade on.

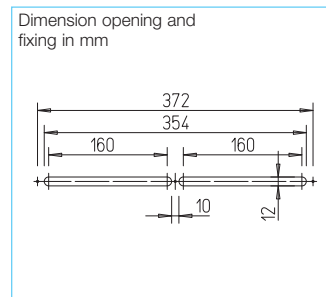

Ordering data	Air flow volume elements to install in window frames			
	ALEF with air flow volume control and limits		ALEFS similar to ALEF, extra attenuation	
Type	ALEF 30	ALEF 45	ALEFS 30	ALEFS 45
Ref. no.	2100	2101	2102	2103
Air flow vol. m³/h	30	45	30	45
Sound insulation D _{n,e} in dB (A)	39	37	41	39
Weight approx. g	190	190	210	210

Ordering data	Air flow volume elements to install in window frames	
	ALEF Hygro – with humidity controlled air flow volume control and limits	ALEFS Hygro similar to ALEF with extra attenuation
Type	ALEF 6/45 Hygro	ALEFS 6/45 Hygro
Ref. no.	2056	2057
Air flow vol. m³/h	6/45	6/45
Sound insulation D _{n,e} in dB (A)	37	39
Weight approx. g	200	220

Seal it up if there is a fire.

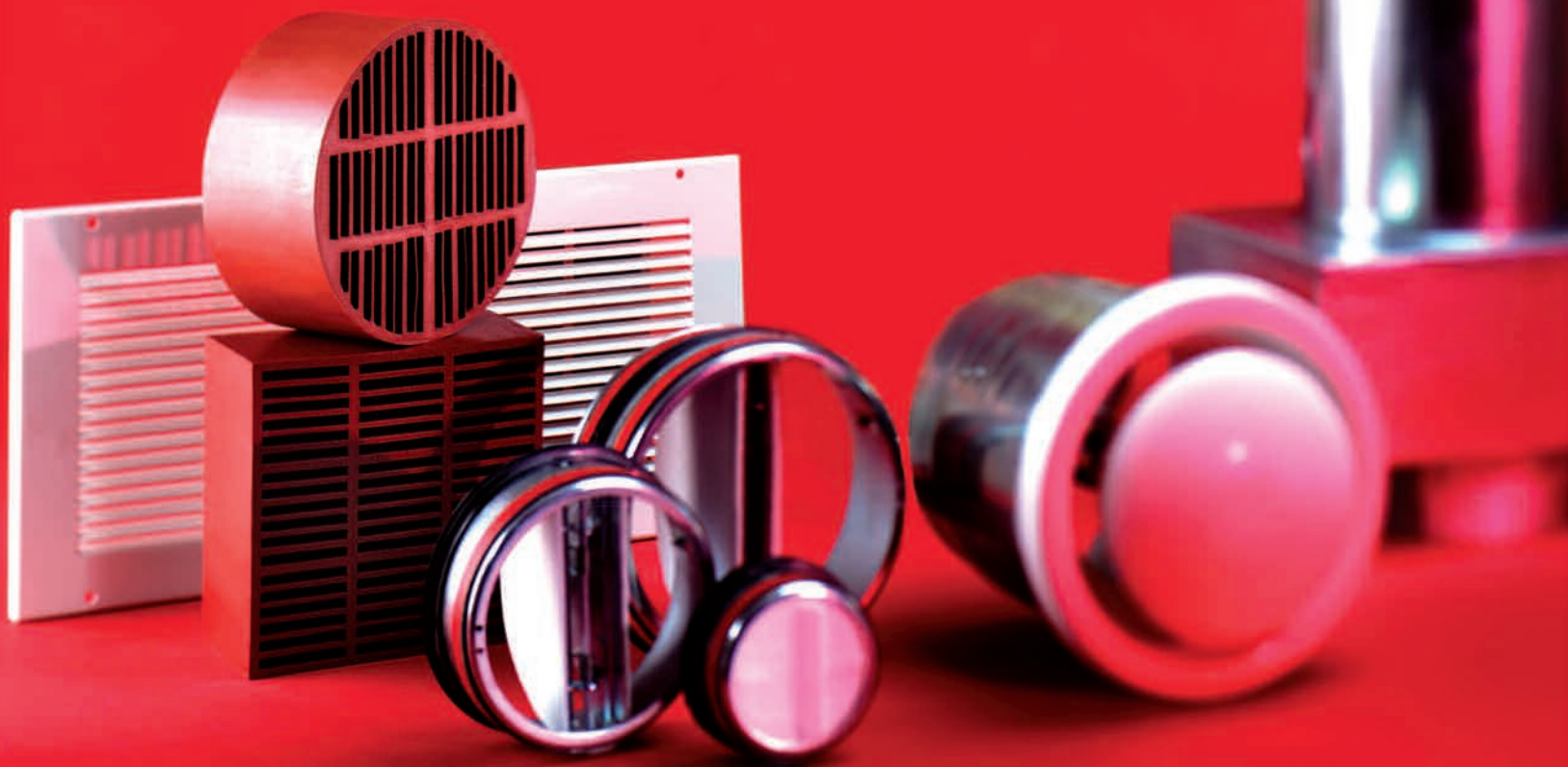

The aim of preventive fire safety in multi-storey buildings is to prevent the spread of fire to adjacent floors and rooms. The construction ordinances therefore divide apartment units or rooms into so-called units of usable area (fire section), the ceilings and walls of which have to fulfil specific requirements in terms of their fire resistance duration.

As supply lines such as ventilation ducts cross fire sections, their openings are to be fitted with shutter elements with the required classifications.

FIRE SAFETY SHUTTER ELEMENTS

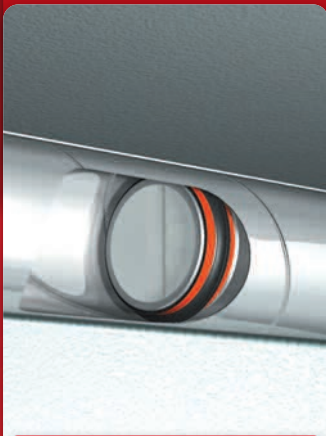

Fire safety shutter elements (BAE/BAK) prevent the transmission of fire and smoke through ventilation ducts or vents into other fire sections.

518

FIRE SAFETY POPPET VALVES



Shutter elements with air flow volume throttling (BTV/BTK) to prevent the transfer of fire and smoke through ventilation ducts or vents.

520

FIRE PROTECTION DAMPERS, COLD SMOKE DAMPERS

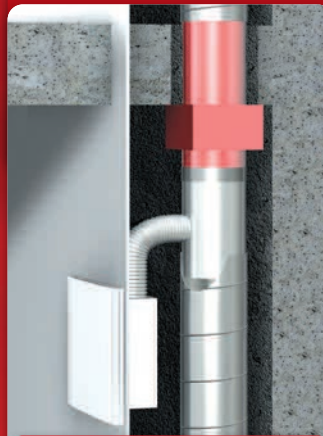

Fire protection dampers (ELS-D) for ventilation ducts according to DIN 18017. With their installation the use of further classified fire protection elements on air intakes / extracts is unnecessary. Ideal for installation shafts with mixed assignments (including those flammable ducting).

Cold smoke dampers (KAK) prevent the ingress of cold smoke into other fire sections. For room-side duct insertion, positioning behind poppet valves or extract air elements.

522

FIRE PROTECTION VENTILATION TILES

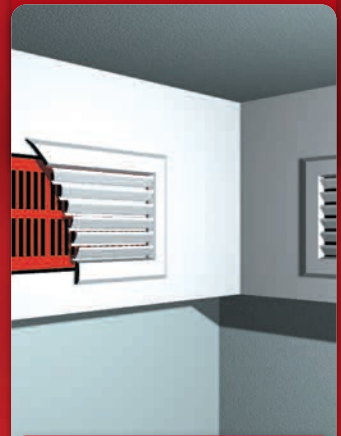

Fire safety ventilation tiles (BLS) enable the static ventilation of trapped persons to prevent the spread of smoke and fire to rooms and chambers to be protected, such as installation shafts, cable channels and the like.

524

BAE

Approval Z-41.3-696
maintenance-free

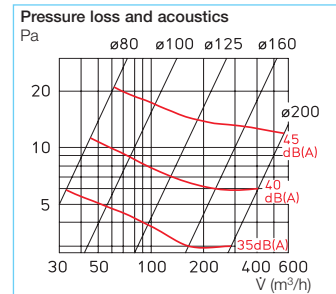

Operation

Shutter to prevent fire and smoke transmission. Suitable for installation in ventilation shafts and ducting with required fire resistance class K 90-18017. Suitable for insertion into spiral ducting or for wall installation with mounting sleeve EH (accessories) and non-fire-resistant suspended ceilings and fire-resistant ceilings as a damper.

Function

When the ambient temperature of +72 °C is exceeded, the integrated thermal coupling releases the spring loaded semicircle blades. Two safety bows interlock the shutter blades.

Official approval

The suitability of this shutter has been tested for use in ventilation systems to DIN 18017 and approved with the German Institute for Building Technology no. Z-41.3-696.

Special features

- Maintenance free.
- Cleaning and inspection together with the respective fan.
- Insertion in spiral ducting without additional wall mounting frame.
- Can be installed outside the shaft wall.
- For air flow in both directions, suitable for extract and supply air systems.
- Lower flow resistance even with high air flow volumes.
- Can be connected to fume extractors or cooker hoods.
- Low sound levels.
- Can also be used for commercial applications e.g. internal toilets, kitchenettes, etc.

Design

Cylindrical duct sleeve with butterfly shutter and integrated thermal coupling.

Delivery

Individually shrink-wrapped.

Installation and setting

- The installation and operating instructions contain the exact guideline relating to operation and installation.
- The specifications of the respective approval must be observed.

Accessories

Limit switch

To control BAE and report its operating status to the central building management system. For mounting on all DN, simple snap-in mounting.



Type BA-S Ref. no. 2585
Switch as change-over IP 67
max. load 5–250 V / 6 A (2 A ind.)
Connect. cable 50 cm long / 3 x 0.34 mm²
Wiring diagram no. 830

Installation examples

Duct installation

The element is to be installed through simple insertion (e.g. in spiral ducting) and to be fixed together with the duct in the wall. Suitable for installation in both directions, independent from air flow direction.

Duct installation

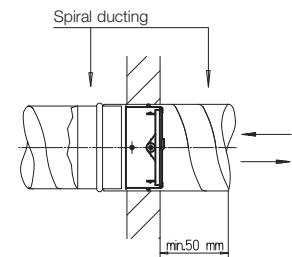

Wall installation

Via mounting sleeve EH (accessory) in walls of brick, thermolite block or plaster panel, shaft partition walls in F 90 and F 30 or system tested walls with more than 40 mm thickness. Suitable for installation in both directions, independent from air flow direction.

Wall installation with mounting sleeve or spiral duct and plug-in supply / extract air element.

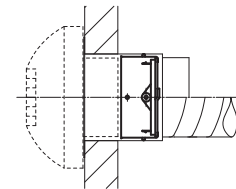

Ceiling installation

- Can be installed in non-fire-resistant suspended ceilings.
- Can be installed in fire-resistant ceilings as a damper unless a free cross-section is required.

Ceiling installation with mounting sleeve and plug-in supply / extract air element. Connection to mains through spiral ducting.

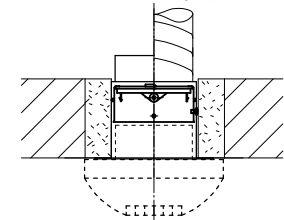

Ordering data					Accessories:						
Type	Ref. no.	Dim. in mm		Weight approx. kg	Mount. sleeve	Ref. no.	Dim. in mm				
		Ø A	B				Ø C	Ø D	E	F	
BAE 80	2624	78	60	0,17							
BAE 100	2625	98	60	0,23	EH 100	2639	100	98	110	140	
BAE 125	2626	123	60	0,30	EH 125	2640	125	123	110	140	
BAE 160	2627	158	60	0,40	EH 160	2641	160	158	110	140	
BAE 200	2628	198	60	0,55	EH 200	2642	200	198	110	140	

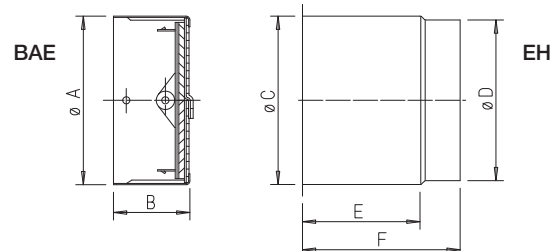

Dim. in mm see table

In accordance with the European Construction Products Regulation, fire dampers required an EC certificate of conformity and declaration of performance since 01.07.2013. Helios BAK meet these European requirements.

Operation

Shutter to prevent fire and smoke transmission. Suitable for installation in ventilation shafts or walls which serve as fire section with required fire resistance class EI 90 S or K 90-4102. Suitable for wall and ceiling installation or as overflow opening. Suitable for insertion into spiral ducting. In case of one-sided duct connection, mounting sleeve EH (accessories) recommended.

Function

When the ambient temperature of +72 °C is exceeded, the integrated thermal coupling releases the spring loaded semicircle blades. Two safety bows interlock the shutter blades.

Official approval

- With EC certificate of conformity and performance declaration according to European Construction Products Regulation 305/2011.
- Test according to EN 1366-2.
- Classified according to EN 13501-3: EI 90 (ve, ho, i→o) S – (300 Pa).
- Corresponds to European Product Standard DIN EN 15650.
- General Technical Approval from German Institute for Building Technology with no. Z-19.18-2180 and Z-41.3-695.

Special features

- Insertion in spiral ducting in space-enclosing component.

BAK

Approval Z-19.18-2180
EC certificate of conformity
BC1-606-0464-15650.69-2517

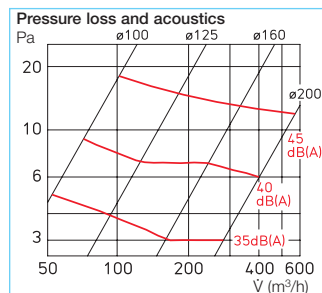

- For air flow in both directions, suitable for extract and supply air systems.
- Lower flow resistance even with high air flow volumes.
- Simple fixing through mounting sleeve (accessory).

Design

Cylindrical duct sleeve with butterfly shutter and integrated thermal coupling.

Delivery

Individually shrink-wrapped.

Installation and setting

- The installation and operating instructions contain the exact guideline relating to operation and installation.
- The specifications of the respective approval must be observed.

Accessories

Limit switch

To control BAK and report its operating status to the central building management system. For mounting on all DN, simple snap-in mounting.



Type BA-S Ref. no. 2585
Switch as change-over IP 67
max. load 5–250 V / 6 A (2 A ind.)
Connect. cable 50 cm long / 3 x 0.34 mm²
Wiring diagram no. 830

Installation examples

Duct installation in wall or ceiling

The element is fixed by inserting into the spiral ducting or the mounting sleeve EH (accessories) and then mounted together to the wall, ceiling or shaft wall. Installation is independent from air flow direction. Completed with connection to ducting on both ends of the mounting sleeve.

Duct installation

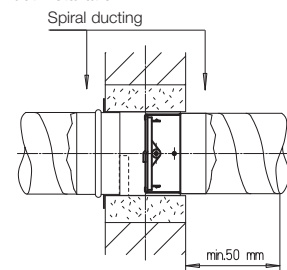

Wall installation

Via mounting sleeve EH (accessory) in walls of brick, thermolite block or plaster panel, shaft partition walls in F 90 and F 30 or system tested walls with more than 40 mm thickness. Suitable for installation in both directions, independent from air flow direction

Wall installation in brick, thermolite block or plaster panel.

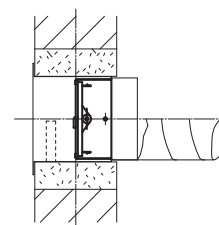

Overflow opening

The technical approval Z-19.18-2180 regulates the use as a shutter for overflow openings. Suitable for installation in tube sleeves from spiral ducting or mounting sleeve EH (accessories).

Ceiling installation in brick, thermolite block or plaster panel.

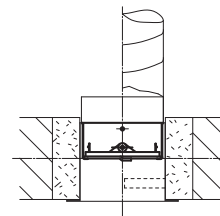

Ordering data					Accessories:					
Type	Ref. no.	Dim. in mm		Weight approx. kg	Mount. sleeve	Ref. no.	Dim. in mm			
		Ø A	B				Ø C	Ø D	E	F
BAK 100	2620	98	60	0,24	EH 100	2639	100	98	110	140
BAK 125	2621	123	60	0,32	EH 125	2640	125	123	110	140
BAK 160	2622	158	60	0,46	EH 160	2641	160	158	110	140
BAK 200	2623	198	60	0,64	EH 200	2642	200	198	110	140

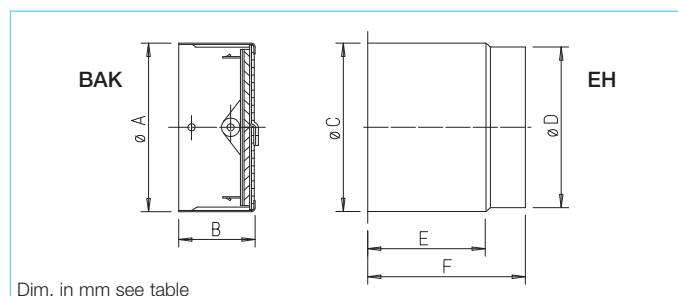

BTV

Approval Z-41.3-694
maintenance-free

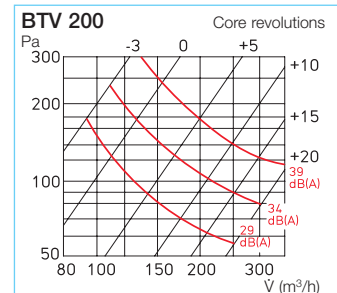
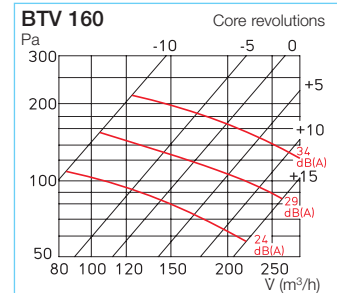
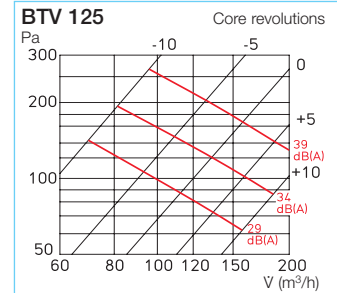
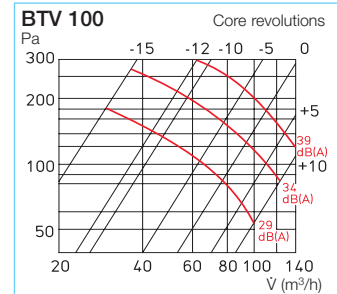

Operation

Shutter to prevent fire and smoke transmission. Suitable for installation in ventilation shafts and ducting with required fire resistance class K 90-18017. Suitable for insertion into spiral ducting or for wall and ceiling installation by means of mounting ring (included in the delivery).

Function

When the ambient temperature of +72 °C is exceeded, the thermal coupling trips. The built-in pressure spring closes the valve automatically.

Official approval

The suitability of this shutter has been tested for use in ventilation systems to DIN 18017 and approved with the German Institute for Building Technology no. Z-41.3-694.

Special features

- Maintenance-free.
- Cleaning and inspection together with the respective fan.
- Officially tested fire protection valve with low air noise at high pressure drop.
- Installation in spiral ducting, shaft walls or non-fire-resistant ceilings.
- High attenuation value.
- Attractive, functional shape.
- Simple adjustment that cannot be changed by unauthorised person reduces the amount of work.
- Can be easily removed only by authorised person for maintenance and cleaning purposes.
- Wide operation range.
- Can also be used for commercial applications e.g. internal toilets, kitchenettes, etc.

Design

Sheet steel construction with white powder-coating. Aerodynamically designed with center core and bell mouth ring.

Delivery

One valve in a polybag incl. mounting ring made of galvanised sheet steel.

Installation and setting

- The installation and operating instructions contain the exact guideline relating to operation and installation.
- Fitted with one hand using the mounting ring (included in the delivery).
- The specifications of the respective approval must be observed.
- Air flow volume settings according to the adjacent diagrams.
- Setting stays fixed and cannot be changed by an unauthorised person without dismantling the valve.



Ordering data

Mounting ring included in the delivery

Type	Ref. no.	Dim. in mm					Weight approx. kg
		Ø A	Ø B	C	D	E	
BTV 100	2634	135	99	17	67	91	0,38
BTV 125	2635	161	124	18	68	103	0,48
BTV 160	2636	191	160	18	68	107	0,64
BTV 200	2637	242	199	17	67	124	0,77

BTV

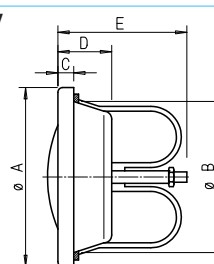

Dim. in mm see table

Installation in walls and non-fire-resistant ceilings with mounting ring (included in the delivery).

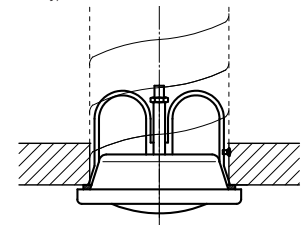

BTK

Approval Z-19.18-2180
EC certificate of conformity
BC1-606-0464-15650.69-2517



In accordance with the European Construction Products Regulation, fire dampers required an EC certificate of conformity and declaration of performance since 01.07.2013. Helios BTK meet these European requirements.

■ Operation

Shutter to prevent fire and smoke transmission. Suitable for installation in ventilation shafts or walls which serve as fire section with required fire resistance class EI 90 S or K 90-4102. Suitable for wall and ceiling installation or as overflow opening. Suitable for insertion into spiral ducting. In case of one-sided duct connection, mounting sleeve EH (accessories) recommended.

■ Function

When the ambient temperature of +72 °C is exceeded, the thermal coupling trips. The built-in pressure spring closes the valve automatically.

■ Official approval

- With EC certificate of conformity and performance declaration according to European Construction Products Regulation 305/2011.
- Test according to EN 1366-2.
- Classified according to EN 13501-3: EI 90 (ve, ho, i↔o) S – (300 Pa).
- Corresponds to European Product Standard DIN EN 15650.
- General Technical Approval from German Institute for Building Technology with no. Z-19.18-2180 and Z-41.3-695.

■ Special features

- Insertion in spiral ducting in space-enclosing component.
- Officially tested fire protection valve with low air noise with high pressure drop.
- High attenuation value.
- Attractive, functional shape.
- Simple adjustment that cannot be changed by unauthorised person reduces the amount of work.
- Can be easily removed only by authorised person for maintenance and cleaning purposes.
- Wide operation range.

■ Design

Polymer valve body, optimum aerodynamical design with centre core and bell mouth ring. Cylindrical duct sleeve with butterfly shutter and integrated thermal coupling.

■ Delivery

Individually shrink-wrapped.

■ Installation and setting

- The installation and operating instructions contain the exact guideline relating to operation and installation.
- The specifications of the respective approval must be observed.

■ Installation examples

Duct installation in wall or ceiling

The element is fixed by inserting into the spiral ducting or the mounting sleeve EH (accessories) and then mounted together to the wall, ceiling or shaft wall. Installation is independent from air flow direction. Completed with connection to ducting on both ends of the mounting sleeve.

Overflow opening

The technical approval Z-19.18-2180 regulates the use as a shutter for overflow openings. Suitable for installation in tube sleeves from spiral ducting or mounting sleeve EH (accessories).

■ Accessories

Limit switch

To control BTK and report its operating status



to the central building management system. For mounting on all DN, simple snap-in mounting.

Type BA-S Ref. no. 2585
Switch as change-over IP 67
max. load 5–250 V / 6 A (2 A ind.)
Connect. cable 50 cm long / 3 x 0.34 mm²
Wiring diagram no. 830

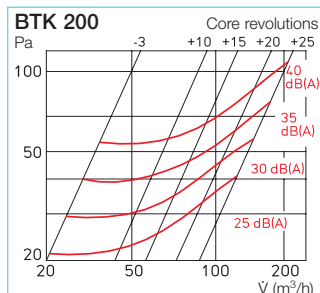
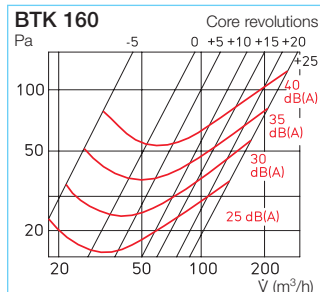
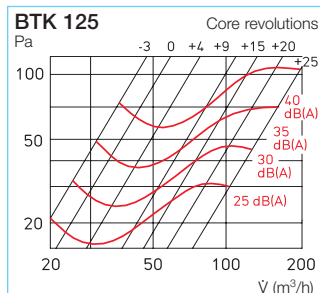
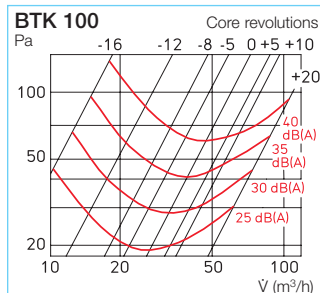

Ordering data

Type	Ref. no.	Dim. in mm					Weight kg	Accessories:		Dim. in mm			
		Ø A	Ø B	C	D	E		Mount. sleeve Ref. no.	Ø F	G	H	Ø I	
BTK 100	2633	150	98	19	129	20	0,45	EH 100	2639	100	110	140	98
BTK 125	2630	165	123	19	129	33	0,60	EH 125	2640	125	110	140	123
BTK 160	2631	220	158	19	129	51	0,85	EH 160	2641	160	110	140	158
BTK 200	2632	245	198	19	129	71	1,20	EH 200	2642	200	110	140	198

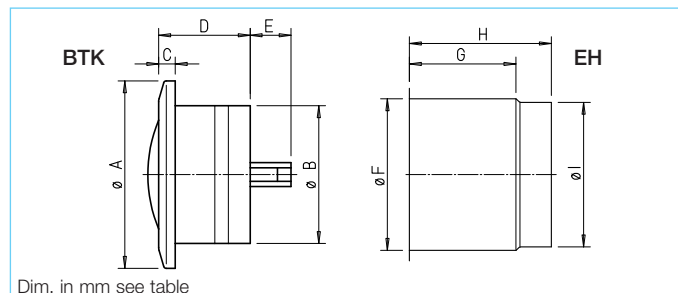

Dim. in mm see table

According to building regulations ventilation ducts that cross more than two storeys vertically must be protected against fire and smoke. These conditions have been fulfilled so far through installing the ventilation duct in a fire proof shaft. This has some disadvantages such as high investment cost, need of large space and longer building time, especially the construction of two shafts (separation of the mixed installation shaft from the ventilation shaft).

■ The use of ELS-D fire dampers results in various benefits such as:

- Ventilation ducting can be placed in mixed installation shaft with simple, 12,5 mm thick plasterboard cladding.
- ELS-D are completely maintenance free. Additional fire resistant elements that might need maintenance are not necessary.
- Allows the in-duct ventilation units to be connected via Aluflex ducting without fire protection sheathing and fire protection damper.
- In central ventilation systems, the poppet valves or air flow controlling extract air elements can be replaced with units made of polymer. In order to avoid cold smoke cold smoke dampers (KAK) to be used.
- The extraction of air from kitchens is admissible.
- The constructional and functional advantages of prewall installations or registers can be unconditionally implemented.
- Approximate reduction of the space required to the DN of the main ducting through axial rotation during installation (width like narrow side forward or diagonal).
- The full cross section of the ventilation duct remains, that means no additional pressure drop. Cleaning and maintenance works are not hindered.



Approval Z-41.3-368 maintenance-free

General Technical Approval from DIBt with no. Z-41.3-368. Fire resistance class: K 90-18017 (three-storey test).

■ Specification

Casing made of galvanised sheet steel with integrated spigot on top and bottom. The top spigot can also be used as ceiling lead through.

■ Two stage function

- The shutter closes first at approx. 90 °C and prevents the transmission of high temperatures to other storeys.
- At approx. 180 °C the integrated fire rated foam seals the ventilation ducting completely above the shutter.

■ Installation

ELS-D can be easily installed single handed vertically against the bottom part of the floor slab or in installation registers. The fire damper is to be fixed with two mounting fish plates, that are held in grating and floor finish. The ceiling leadthrough is already integrated in ELS-D. Thanks to the standard connection nozzles the main ducting can be simply imposed and inserted to the other side like a fitting.

■ Accessories

Cold smoke damper

Prevents any reverse flow of cold smoke in central ventilation systems and much else in other ventilation zones while the fan is not working. (Not required in individual ventilation systems.)

Type KAK 100 Ref. no. 4097
DN 100 mm

Type KAK 125 Ref. no. 4098
DN 125 mm

■ Note

Further sizes and product details for use of the cold smoke damper KAK.

see page 523

- Legend**
- 1 Fire damper ELS-D
 - 2 Ceiling grouting
 - 3 Installation shaft cladding e.g. 12,5 mm plasterboard panels
 - 4 Main ducting (spiral duct)
 - 5 Connection ducting (Aluflex)
 - 6 Insulation against condensation
 - 7 ELS individual ventilation units surface of flush mounting without fire protection requirements
 - 8 Central fan, e.g. DV EC (see page 65 on)
 - 9 Cold smoke damper KAK
 - 10 Extract air element AE or poppet valve (KTVA or MTVA)

System with in-duct fans

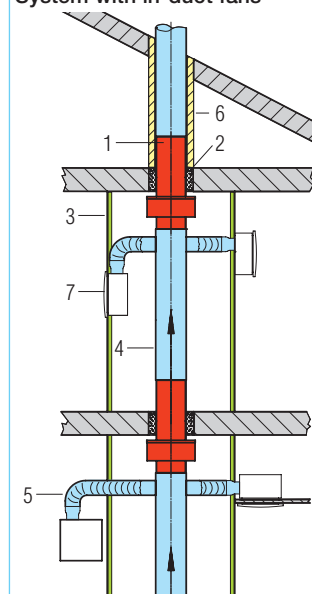

System with central fan

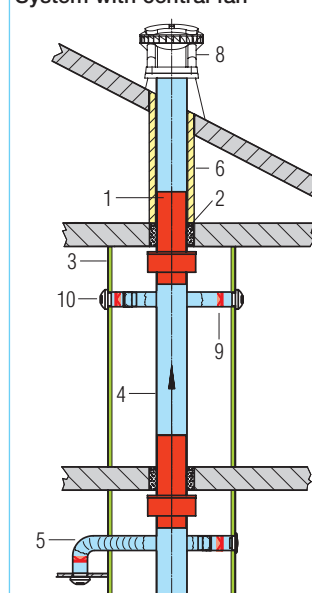

Ordering data

Type	Ref. no.	Dim. in mm								Weight approx. kg
		A	B	C	Ø d	Ø D	E	F	H	
ELS-D 100	0270	183	123	385	99	102	50	250	85	2,5
ELD-D 125	0185	208	148	394	124	127	50	250	94	3,4
ELS-D 140	0186	233	163	403	139	142	50	250	103	4,0
ELS-D 160	0187	258	183	413	159	162	50	250	113	5,0
ELS-D 180	0188	283	203	424	179	182	50	250	124	6,0
ELS-D 200	0271	308	223	434	199	202	50	250	134	7,2

Dim. in mm

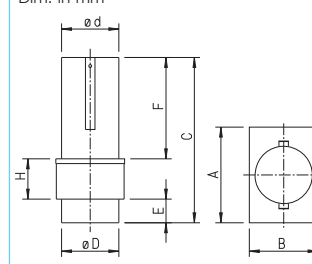

The following is stipulated in the Model Building Regulation and various Regional Construction Ordinances:

The spreading of fire and smoke must be prevented!

The automatic Helios cold smoke damper with magnetic lock meets this requirement. They seal the supply or extract air system as required in fire regulations.

Application

According to DIN 18017-3 the central extract ventilation systems in multi-storey dwellings have common mains and a central fan that is specified above or below the ceiling.

The affiliated rooms (e.g. kitchen, bathroom, toilet) in the respective storey ventilation zone) are ventilated through the extract air ducting. The mains cross multiple ventilation zones they must be led into a fire-resistant (F90 classified) shaft. The extract air vents in each ventilation zone must be equipped with fire dampers or fire safety valves. These costly and space occupying solutions can be replaced with certified fire dampers which are integrated or moulded on the route of mains in the ceiling area. Thereby the mains can be integrated in the installation shaft.

Regional building regulations as well as general technical approvals for shut-off elements and fire dampers ensure that an exhaust air flow on the vertically attached shut-off device in the mains must always be secured to outside through the mains. The requirement becomes relevant, if the central fan breaks down, in case of fire and the

KAK



smoke reaches to the mains in the room due to excess pressure and also enters areas (other ventilation zones) which are not affected by fire due to upcoming air pressure through openings (poppet valves).

The Helios cold smoke dampers KAK with magnetic lock prevent cold smoke from entering other ventilation zones. They must be positioned in all supply / extract air vents behind the poppet valves or extract air elements (also in combination with BAE/BAK).

Design

- Ready to install element for insertion in ducting and fittings.
- Frames with surrounding U-lip seal ring made of EPDM gasket to seal the ventilation duct.
- Shutter frames on both sides made of polymer with metal insert encompass the silicon membrane. Therefore the shutter sits quietly in the air stream.
- A permanent magnet which seals the shutter at low pressure levels is located on a thread axis in the inner cylinder frame.
- Closing and opening pressure can be adjusted to the installation circumstances.

- The very low installation depth and the asymmetric shape of the shutter frames, which ensure a big opening angle, are particularly beneficial.

Installation and setting

- While inserting KAK into ducting, the air flow direction must be considered.
- For vertical installation with horizontal air flow, the horizontal positioning of rotation axis must be considered.
- Positioning must be directly behind the poppet valve or behind the air inlet/outlet.

- Legend**
- 1 Fire damper ELS-D
 - 2 Ceiling grouting
 - 3 Installation shaft cladding e.g. 12.5 mm plasterboard panels
 - 4 Main ducting (spiral duct)
 - 5 Connection ducting (Aluflex)
 - 6 Insulation against condensation
 - 7 Central fan, e.g. type DV EC (see page 65 on)
 - 8 Cold smoke damper KAK
 - 9 Extract air element AE or poppet valve (KTVA or MTVA)

System with central fan

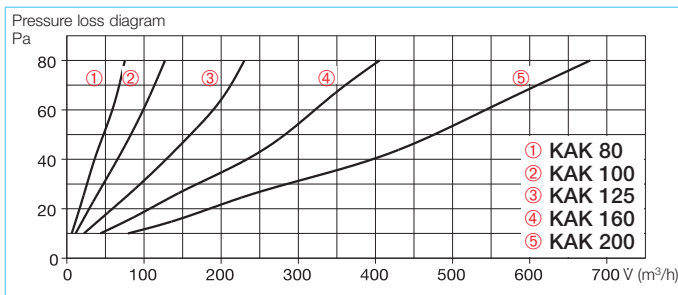
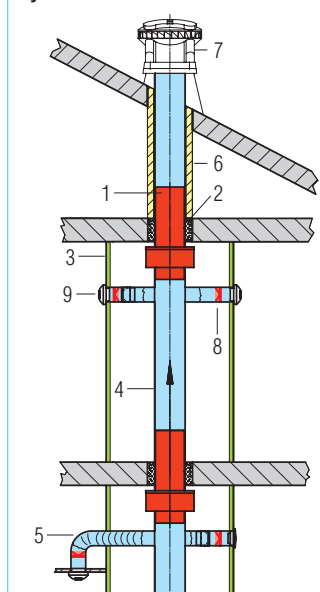

Ordering data

Type	Ref. no.	Dim. in mm		
		Ø D	A	B
KAK 80	4096	79	12	63
KAK 100	4097	95	20	60
KAK 125	4098	120	20	83
KAK 160	4099	155	20	110
KAK 200	4100	196	20	150

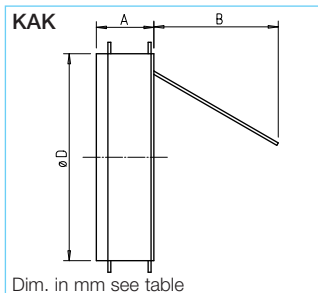

Fire protection ventilation tiles allow intake and extract ventilation in rooms and compartments protected against fire and smoke transmission, such as installation shafts and cable ducts. They enable a constant, static air change, which prevents the heat build-up in the closed compartments. Furthermore, the tiles serve as air vent openings in the walls of necessary corridors (emergency routes), as long as the openings are located on the lower part of the wall.

Special features

- Fire resistance class F 30 to F 120 conforms to DIN 4102 part 2 (see the box on the right).
- BLS consists of intumescent painted building material with DIBt approval. Furthermore, the regulations for the use and installation of BLS should be taken from the general technical approval no. Z-19.18-2065.
- Maintenance and inspection-free, no moving parts.
- Simple installation.
- Resistant against humidity, most oils, benzene and weak acids.

During the installation process the classification of building components is not affected. The ventilation tiles are finished with organic intumescent material, that foams up under the effect of heat. Openings, slots and joints close and thereby prevent fire and smoke transmission.

Each brick is delivered with two ventilation grilles made of galvanised sheet steel. These should be attached once the tile is in position on one side or both sides as mechanical protection and optical cladding depending on the area of application, i.e. screwed to the construction (wall).

Rectangular fire protection ventilation tiles must be installed horizontally.

In case of weaker walls, on-site reinforcement with fibre silicate frames in area of BLS.

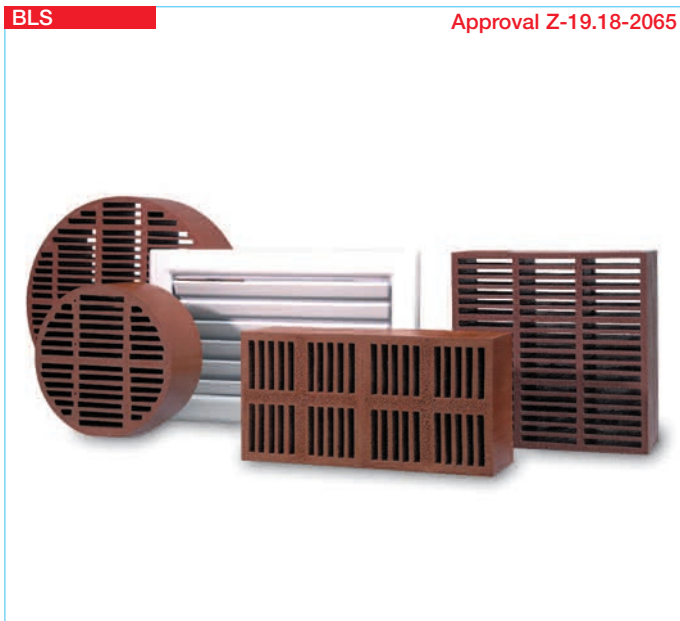

Fire resistant class	Ventilation tile installation in	Thick. mm	Legend
F 30	Brick and concrete walls. Light partition and shaft walls, classified cable ducts.	75	① Brick wall ② Ventilation tile ③ Ventilation grille, both sides ④ Fibre silicate panels
F 90 / F 120*	Brick-built and concrete walls.	75	
	Light partition wall, classified shaft walls and cable ducts.	75	

* Cover grilles on both sides

Air flow volumes – Differential pressure

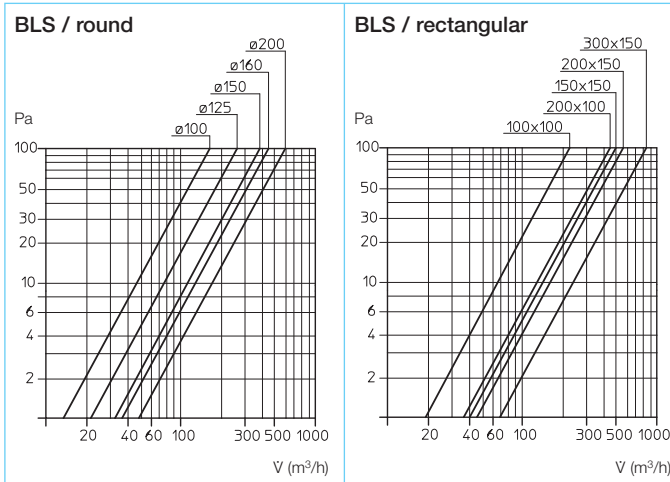

Product range, dimensions in mm									
Ventilation tile				Ins. opening max. i.L.	Wt. kg	Free cross-section cm²	Cover grille		
Ref. no.	Type	Ø	D				W	H	
2712	BLS 100	100	75	Ø 103	0.21	37	200	200	
2715	BLS 125	125	75	Ø 128	0.50	56	200	200	
2767	BLS 150	150	75	Ø 153	0.60	85	200	200	
2718	BLS 160	160	75	Ø 163	0.67	102	255	255	
2721	BLS 200	200	75	Ø 204	1.12	158	255	255	
		W	H	D			W	H	
2766	BLS 100/100	93	93	75	103 x 103	0.38	35	200	200
2724	BLS 150/150	150	150	75	153 x 153	0.80	115	255	255
2727	BLS 200/100	186	93	75	203 x 103	0.75	69	305	155
2730	BLS 200/150	200	150	75	203 x 153	1.15	153	305	200
2733	BLS 300/150	300	150	75	303 x 153	1.56	230	405	205

Installation in brick walls and concrete walls F 30 – F 120

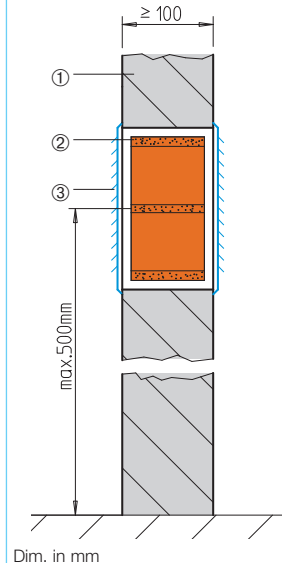

Installation in classified partition wall and cable duct F 30 and F 90

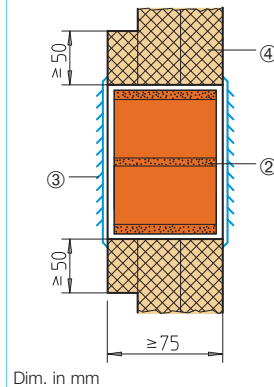

Installation in classified partition wall and cable duct F 30 – F 120

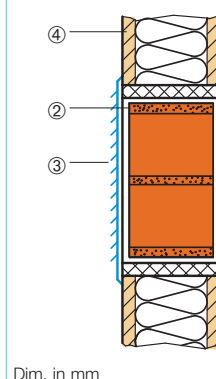

Comfortably controlled and energy-saving.

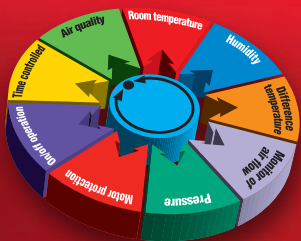

Controlling ventilation and air conditioning systems in accordance with changing requirements and conditions is a must for comfortable, energy efficient ventilation.

MEASURE

Changes in room occupancy, deteriorations in the quality of air at different times, fluctuating temperatures, day and night settings, etc. call for corresponding adjustments. Helios offers regulation, control and switch devices for all functions, which are tailored to the fans.

CONTROL

Complete system solutions bring the maximum possible security for the user and full guarantee by Helios. Furthermore, a lot of time can be saved during planning, installation and operation if the control and regulation devices are perfectly adapted to the fans and their functions. Problems are solved before they emerge.

REGULATE

The extensive MSR range from Helios provides the ideal solution for any application and simultaneously meets all requirements in relation to energy saving and noise reduction.

Task	Helios controller solution	Page
Manual control of air flow volume	Manual speed controller – Without motor protection – 10 V, 24 V DC – Potentiometer for EC fans – 230 V~ – Electronic, flush / surface mounted – 230 V~ – Transformer, surface mounted – 400 V 3~ – Transformer, surface mounted – 230 V~ – Transformer, electronic, surface mounted – With built-in motor full protection for connection to thermal contacts – 230 V~ / 400 V 3~ – Transformer, surface mounted – 400 V 3~ – Electronic, surface mounted – 400 V 3~ – Frequency inverter	PU / PA, SU / SA 541 ES, BSX 531 TSW, TSSW 532 TSD, TSSD 533 ETW 535 MWS / RDS 532 f. ESD 535 FU 536 f.
	Operation switch for fans with 2 speeds – Pole switch for Dahlander windings, flush / surface mounted – Pole switch for separated windings, flush / surface mounted	PDA / PDU 529 PGWA / PGWU 529
	Overrun timer	Overrun switch Thermal electric, electronic, mechanic with adjustable and fixed times ZT, ZNE, ZNI, ZV 527
	Air quality – automatic system Air flow velocity	Air quality sensor with on / off function depending on room air quality ACL 543
		Air flow monitor for monitoring the minimum air flow velocity in ducts and pipes SWE, SWT 543
	Room temperature dependant	Ventilation thermostat – one step with on / off function – four step, mechanical – stepless, electronic TME 1 542 TME 4 534 EST 534
		Temperature controllers with integrated power unit, surface mounted – 230 V~ – electronic – 230 V~ / 400 V 3~ – transformer EUR 6 C 538 KTRW / KTRD 534
		Differential temperature controller electronic, stepless, with power unit for surface mounting – 230 V~ EDTW 543
	Humidity dependant control	Humidistat with on / off function, surface mounted HY 3 542
	Temperature, pressure, speed Pressure dependant control	Fans for sanitary areas with integrated humidity control M1/.. F, ELS-VF 22,53
Universal controller with power unit 230 V~ with 0-10 V DC output, for EC fans with power unit 400 V~ EUR 6 C 538 EUR EC 539 FU 536 f.		
Differential pressure controllers, surface mounted, with digital display – 0-10 V DC – electronic EDR 540		
Motor protection against overload	Differential pressure switch for monitoring the air filters, system pressure and fan operation DDS 542	
	Motor full protection switch to connect the thermal contacts for monitoring the windings temperature MD, MW M 2, M 3, M 4 530	
	Motor protection tripping unit for PTC – temperature sensor in windings MSA 530	
Operation switch	Reverse switch to change air flow direction of axial fans WS 528	
	Isolation switch to disconnect all phases for service works RS, RHS 528 f.	
	Pole / reverse switch as before, but for 2 speed axial fans PWGW, PWDA 529	
Timer	Weekly autotimer for automatic operation control WSUP, WSUP-S 527	



Flush mounted overrun timer for installation in gang boxes behind a switch

Specially designed overrun timer for bathroom and toilet. The compact design allows installation behind a switch within a single gang box. Operation via on / off switch or ideally to be combined with a light switch in rooms without a window. Can be individually adjusted through different timer variations.

Interference immunity and emission
ZT is designed with a thermal electric circuit, is immune against tolerable peak voltages and interference-free. The interference immunity and emission of ZNE/ZNI comply with the latest EN guidelines. ZV is tested as follows: Interference emission to DIN EN 55014 / VDE 0875-14-1; DIN EN 50370 / VDE 0875-1; DIN EN 61000-3-3 / VDE 0838-3.

Overrun timer for mounting in terminal box

Weekly autotimer Surface mounted or in flush mounted box

Control cabinet installation

Type ZT Ref. no. 1277
Thermal electric overrun timer with adjustable run on time, depending on duty cycle.
Optional delayed start via different wiring options.
In parallel wiring with light switch the fan can be temporarily switched off via a series switch.

Type ZNE Ref. no. 0342
Electronic overrun timer with stepless adjustable run on times
Operation via on / off switch, e.g. in combination with light switch.
Compact design allows easy installation.

Type ZNI Ref. no. 0343
Electronic interval switch with adjustable interval and run on times
Starts operation automatically at adjustable time intervals, if no manual switching has taken place.
If switched manually, e.g. light switch, the preset overrun time applies.

Type ZV Ref. no. 1279
Electronic overrun timer with stepless adjustable run on times and operation switch with run on time/continuous operation options.
Parallel wiring to a light switch and fan is possible via an on / off switch or push button.

Type WSUP Ref. no. 9990
Weekly autotimer
Digital autotimer with LCD display to automatically control any unit in accordance with the technical data. Suitable for switching the least electronic current from 1 mA / 20 mV through a standard, gilded μ -contact. Installation in dry environment.

Type WSUP-S Ref. no. 9577
Weekly autotimer for control cabinet installation
Digital autotimer with LCD display to automatically control any unit in accordance with the technical data. Suitable for switching low-voltage or low currents through a standard, gilded μ -contact. Installation in dry environment or with occasional condensation.

Variable run on time, depending on duty cycle.
Min. approx. 2 min.; max. approx. 12 min.
Optional delayed start (approx. 45 sec.)
Voltage 230 V, 1~, 50/60 Hz
Current 4 A (ind.)
Protection class IP 20
Dimensions mm W 32 x H 40 x D 14
Installation flush mount box behind switch
Wiring diagram no. SS-174
– when two rooms/switches are to be controlled SS-174.3

Stepless adjustable run on time 0–21 min.
Optional delayed start 45 sec.
Voltage 230 V, 1~, 50/60 Hz
Current min. 0.05 A max. 0.8 A (ind.)
Protection class IP 40
Dimensions mm W 17 x H 37 x D 13
Installation flush mount box behind switch
Wiring diagram no. SS-477.1
– when two rooms/switches are to be controlled SS-174.3

Adjustable interval time 0, 4, 8, 12, 24 hr.
Run on time if manually switched, stepless adjustable 0–21 min.
Optional delayed start 45 sec.
Voltage 230 V, 1~, 50/60 Hz
Current min. 0.05 A max. 0.8 A (ind.)
Protection class IP 40
Dimensions mm W 17 x H 37 x D 13
Installation flush mount box behind switch
Wiring diagram no. SS-477.1
– when two rooms/switches are to be controlled SS-174.3

Stepless adjustable run on time 4–15 min.
Voltage 230 V, 1~, 50/60 Hz
Current 2,1 A (ind.)
Protection class IP 20
Dimensions mm W 18 x H 93 x D 67
Installation terminal box, 35 mm sectional rail
Wiring diagram no. SS-236.1

Voltage 230 V, 1~, 50 Hz
Current 1 mA / 20 mV DC
Switching contact potential-free changeover 250 V, 1~, 8 A $\cos \varphi \approx 1$, μ -contact
Protection class IP 20 / II
Dimensions mm W 85 x H 85 x D 52
Installation surf. casing, flush box
Temperature range -10° C to +35° C
Memory space (switching time) 42
Wiring diagram no. SS-862

Voltage 230 V, 1~, 50-60 Hz
Current 1 mA / 20 mV DC
Switching contact potential-free changeover 250 V, 1~, 16 A $\cos \varphi \approx 1$ 2 A $\cos \varphi \approx 0.6$, μ -contact
Protection class IP 20 / II
Dimensions mm W 36 x H 90 x D 69
Installation DIN rail mounting control cabinet
Temperature range -30° C to +55° C
Memory space (switching time) 56
Wiring diagram no. SS-1038



Reversing switch

For surface and flush mounting

Type WS **Ref. no. 1271**
To change air flow direction of 1 ph. and 3 ph. axial high performance fans. Installation: Surface or flush mounted (switch box is included as standard). With screw fixing (M 3, 60 mm). Similar to product pages the units are specified in the model chart.

Current AC 3 / 5.5 kW / 12 A (ind.)
Voltage 230 V, 1-, 50/60 Hz
400 V, 3-, 50/60 Hz
Protection class IP 54
(when flush mounted IP 30)
Wiring diagram no. SS-752
Weight approx. 0.4 kg
Dimensions mm W 91 x H 121 x D 109
– when flush mounted W 72 x H 72 x D 35
Casing polymer, light grey



Reversing, speed and on/off switch

Installation in FM switch box

Type DSEL 2 **Ref. no. 1306**
1. **Speed changeover switch** and on/off switch of fans with two speed steps such as ELS-V 60/35, -VN 100/60.
2. **Reverse switch** for changing the air flow direction of reversible fans (for supply and extract air) and on/off switch.
Similar to product pages the units are specified in the model chart.

Two switch rockers with symbols for speed change or reverse operation delivered as standard. Colour pure white.
Current 3 A (ind.)
Voltage 230 V, 1-, 50/60 Hz
Protection class IP 30
Installation in standard FM box
Wiring diagram no. – two speed SS-827
– reverse operation SS-828
Dimensions mm W 80 x H 80 x D 15
Weight approx. 0.1 kg



Three speed and operating switch with 0 position

Installation in FM switch box

Convenient flush mounted speed switch for fans with three speed steps. Cannot be parallel wired with the light switch
Voltage 230 V, 1-, 50/60 Hz
Weight approx. 0.1 kg

Type DSEL 3 **Ref. no. 1611**
Can be used with the fan models ELS-V 100/60/35 and ZEB 380.
Type DSZ **Ref. no. 1598**
Can be used with the central extract air box ZEB EC.



Speed, operation and reversing switch

For surface and flush mounting

Type FR 22/30 **Ref. no. 0998**
Suitable for fan models GX 225 or 300.
For surface and flush mounted installation in dry rooms.
Three sliding switches with following functions: Two pole operation switch on/off with operating display, high or low speed and reverse switch (supply/extract air).

Current approx. 0.8 A (ind.)
Voltage 230 V, 1-, 50/60 Hz
Protection class IP 20
Dimensions mm W 210 x H 85 x D 55
Weight approx. 1.2 kg
Wiring diagram no. SS-497
Casing polymer, white



Isolation switch
– 3 pole with auxiliary contact for direct starting

Type RS 3+1 7.5 **Ref. no. 6387**
Plastic casing for flush mounting. Locking options in position "0 OFF" and "I ON".

Technical data
Voltage 400 V, 3-, 50/60 Hz
Operating current 20 A
Current AC-23 B, 7.5 kW
Protection class IP 65
Protection category II
Actuation Rotary actuator
Temperature range -25 to +60 °C
Dimensions mm W 90.5 x H 90.5 x D 102
Weight approx. 0.3 kg
Wiring diagram no. SS-1088
Casing UV and weather-resistant



Isolation switch
– 6 pole with auxiliary contact for Dahlander windings or Y/Δ starting

Type RS 6+1 7.5 **Ref. no. 6388**
Current 20 A, AC-23 B, 7.5 kW
Dimensions mm W 90.5 x H 90.5 x D 139
Weight approx. 0.4 kg

Technical data
Voltage 400 V, 3-, 50/60 Hz
Protection class IP 65
Protection category II
Actuation Rotary actuator
Locking options "0 OFF" and "I ON"
Temperature range -25 to +60 °C
Wiring diagram no. SS-1088
Casing UV and weather-resistant for surface mounting

Type RS 6+1 11 **Ref. no. 6389**
Current 25 A, AC-23 B, 11 kW
Dimensions mm B 115 x H 115 x T 163
Weight approx. 0.6 kg



Isolation / main switch
– 3-pole with auxiliary contact

Type RHS 3+1 Ref. no. 1594
Position "0" is lockable via padlock. Conforms to DIN EN 60204 T.1 / VDE 0113-1. Polymer casing for surface mounting. 3-pole isolator with additional terminals, for single speed and speed controlled fans.

Technical data
Voltage 400 V, 3~, 50 Hz
Current
– Main contact AC 3 / 5.5 kW 12 A ind.
– Aux. contact AC 3 / 2,2 kW 4 A ind.
Protection to IP 54
Dimensions mm W 101 x H 126 x D 104
Weight approx. 0.35 kg
Wiring diagram no. SS-505.2



Isolation / main switch
– 6-pole with 2 auxiliary contacts

Type RHS 6+2 Ref. no. 1595
Position "0" is lockable via padlock. Conforms to DIN EN 60204 T.1 / VDE 0113-1. Polymer casing for surface mounting. 6-pole isolator with 2 additional terminals, for all pole changing fans.

Technical data
Voltage 400 V, 3~, 50/60 Hz
Current AC 3 / 5.5 kW
Protection to IP 65
Dimensions mm W 82 x H 82 x D 125
Weight approx. 0.3 kg
Wiring diagram no. SS-505.3



Pole switches
– for separate windings PGWA
– for Dahlander windings PDA

For surface mounting

Surface mounted operation switch for pole changing fans.

Type	Ref. no.	Current	SS no.
For separate windings			
PGWA 12	5083	AC 3/5.5 kW 12 A	345
PGWA 25	5061	AC 3/11 kW 25 A	345
For Dahlander windings			
PDA 12	5081	AC 3/5.5 kW 12 A	733 ¹⁾
PDA 25	5060	AC 3/11 kW 25 A	733 ¹⁾

¹⁾ For motors without thermal contacts: SS-732.

Technical data for all types
Voltage 400 V, 3~, 50/60 Hz
Protection to IP 65

Type	Dim. mm			Weight kg
	B	H	T	
P 12	82	82	130	0.4
P 25	92	92	140	0.5



Pole switches
– for separate windings PGWA
– for Dahlander windings PDU

For flush mounting

Pole switch PGWU/PDU
Flush mounted operation switch for pole changing fans.

Type	Ref. no.	Current	SS No
For separate windings			
PGWU 12	5084	AC 3/5.5 kW 12 A	345
For Dahlander windings			
PDU 12	5082	AC 3/5.5 kW 12 A	733 ¹⁾

¹⁾ For motors with thermal contacts; without thermal contacts: Connection to wiring diagram no. SS-732.

Technical data for both types
Voltage 400 V, 3~, 50/60 Hz
Protection to IP 30
Dim. mm Installation depth 87
Excess length 40
Cover plate 80 x 80
Delivery incl. flush mounting box
Weight approx. 0.2 kg



Reverse and pole switch
– for separate windings PWGW
– for Dahlander windings PWDA

For surface mounting

Type PWGW Ref. no. 1281
For separate windings

Type PWDA Ref. no. 1282
For Dahlander windings

To switch speed and air flow direction of individual pole changing fans. Grey polymer casing.

Technical data for both types
Voltage 400 V, 3~, 50/60 Hz
Current AC 3 / 7.5 kW
Protection to IP 55
Dimensions mm W 96 x H 105 x D 147
Weight approx. 0.5 kg
Wiring diagram no. for PWGW SS-13
Wiring diagram no. for PWDA SS-11



Speed reversing switches DS 2
– for two speed three phase Y/Δ fans

– for two speed alternating current fans (SlimVent, RR)

Type DS 2 Ref. no. 1351
On/off and speed reversing switch for two speed three phase Y/Δ-fans. Grey polymer casing for surface mounting.

Type DS 2/2 Ref. no. 1267
On/off and speed reversing switch for two speed 1 ph. fans, RR and SlimVent SVR, SVS.

Technical data for both types
Voltage 400 V, 3~, 50/60 Hz
Current AC 3 / 5.5 kW / 12 A
Dimensions mm W 82 x H 82 x D 130
Weight approx. 0.4 kg
Protection to, Type DS 2 IP 65
Wiring diagram no. for Type DS 2 SS-87
Protection to, Type DS 2/2 IP 54
Wiring diagram no. for Type DS 2/2 SS-939



■ **Motor protection**

Regulations and standards

The harmonised European standards and national installation directives require thermal overload protection for electric motors. This can be achieved in various ways and depends on the motor specification.

- Optimal protection is provided by thermal contacts ("TK" consecutively), which monitor the motor winding temperature. These contacts protect also the speed controlled motors.
- For low motor powers, the thermal contacts are wired in series with the motor windings, in other words, they are internally wired. This ensures an automatic function (resetting after cooling), without the operator reacting necessarily on the interference.
- For motors/fans with higher performances the leads of the thermal contacts or PTC thermistor-temperature sensor are wired to the terminal block and must be connected to the adjacent motor full protection/tripping units. Only under this condition is the warranty claim valid.
- Motors/fans without thermal monitoring elements in the windings (e.g. IEC norm motors) must be secured on all poles by a suitable motor protection switch.

For 1 ph. fans with thermal contact leads wired to the terminal block

Motor full protection switch MW
in polymer casing for surface mounting or installation in fuse board (clamping assembly for support rail).



For 3 ph. fans with thermal contacts

Motor full protection switch M
Operation and full protection unit in polymer casing for surface mounting or installation in fuse board (clamping assembly for support rail).



For pole changing 3 ph. fans with separate windings and thermal contacts

Motor full protection switch M 2
Switching and full protection unit in light grey polymer casing with control lamp for surface mounting.



For pole changing 3 ph. fans with Dahlander windings and thermal contacts

Motor full protection switch M 3
Design and functions as M 2.

For two speed 3 ph. fans with Y/Δ switching and thermal contacts

Motor full protection switch M 4
Design and function as M 3.



For 3 ph. fans with built-in positive temperature coefficient thermistors (PTC temperature sensors) for thermal motor protection. Specified for use in speed controlled, explosion proof fans.

Motor full protection switch MSA
Tripping unit with manual reset for 1 to 6, PTC thermistors wired in series.



If the nominal response temperature in PTC thermistors reaches a set limit the built-in relay disconnects the motor. The fault is indicated by a light emitting diode. Restarting via pressing the "Reset" button or an external switch. Casing made of polymer, suitable for fuse board installation on support rail according to DIN EN 60715.

Type MW

Ref. no. 1579

On/off operation via push-button switch. Manual reset function interference.
Volt free auxiliary contact for connection of failure indication alarm.
230 V, 1~, 50/60 Hz, applicable from 80 V
Nominal current 0.4 to 10 A
Protection to IP 55 Weight approx. 0.5 kg
Dimensions mm W 80 x H 140 x D 95
Wiring diagram no. SS-517

Type MD

Ref. no. 5849

On/off operation via push-button switch. Manual reset function interference.
Volt free auxiliary contact for connection of failure indication alarm.
400 V, 3~, 50/60 Hz, applicable from 80 V
Nominal current 0.1 to 25 A
Protection to IP 55 Weight approx. 0.5 kg
Dimensions mm W 80 x H 140 x D 95
Wiring diagram no. SS-518

Type M 2

Ref. no. 1292

If the thermal contact opens the motor disconnects from the supply. Restarting after interference via "0" position on the switch.

Voltage 400 V, 50/60 Hz
Power AC 3 / 5.5 kW
Nominal current approx. 12 A
Protection to IP 55 Weight approx. 1.0 kg
Dimensions mm W 170 x H 135 x D 115
Wiring diagram no. SS-142

Type M 3

Ref. no. 1293

As M 2, but suitable for pole changing 3 ph. fans with Dahlander windings and built-in thermal contacts.
Dimensions mm W 170 x H 135 x D 135
Wiring diagram no. SS-143

Type M 4

Ref. no. 1571

As M 3, but suitable for two speed 3 ph. fans with Y/Δ switching and built-in thermal contacts.
Wiring diagram no. SS-144

Type MSA

Ref. no. 1289

For thermal protection of electric motors (even explosion-proof electric motors) according to Directive 2014/34/EU (ATEX) with integrated PTC temperature sensors according to DIN 44081 and DIN 44082.

Voltage 230 V ± 15 %, 50/60 Hz
3 phase operation via contactor
Current at 230 V 3 A AC 15
Connection options 1 to 6 PTC thermistors in series

Tested by Physikalisch-Technische Bundesanstalt, according to
DIN EN 60079-14 / VDE 0165-1,
DIN EN 60079-0 / VDE 0170-1,
DIN EN 60079-17 / VDE 0165-10-1.
Protection to IP 20
Weight approx. 0.2 kg
Dimensions mm W 35 x H 90 x D 58
Wiring diagram no. SS-325.1

Information	Page
Technical information	15 on
Transformer controllers with motor full protection unit	
– for 1 ph. motors MWS	532
– for 3 ph. motors RDS	533

■ Electronic speed controller for stepless speed control of single phase fans

- Multiple, different fans can be operated with a controller up to the full load capacity. A reserve of 10% must be considered when calculating.
- The minimum output voltage can be adjusted to motor characteristics via potentiometer. Values must not fall below the lower limit for liquid motor start-up!
- Overload protection from built-in fine wire fuse.
- Additional connection of indicator lights or shutter possible via unregulated output.
- Corresponds to EMC guidelines, DIN EN 50370, DIN EN 61000 / VDE 0838, DIN EN 55014, DIN EN 60669.

■ Version ESU 1 and ESU 3 A HELIOS innovation

- Both types are compatible with the standard light switch programmes of many manufacturers. Thus, the speed controller can be integrated in the existing switch programme on-site. Colour matching is also not a problem. Frame, central insert and rotary knob are taken from the "dimmer programme" of the switch series and connected.
- Standard delivery includes: Controller insert, flush mounted cover plate and rotary knob made from white polymer.
- Operating display through circumferential light ring on rotary knob.

■ Surface mounted models

- Attractive, totally closed casing of polymer.
- ESA 1 and ESA 3 with illuminated control knob.

■ Important note

- Only motors which are suitable for speed control via electronic control should be used.

■ Electronic speed controllers

which operate on the phase control principle, can create humming noises which can be considered disturbing in the lower speed/voltage range. Silent transformer controllers should be used for noise-critical applications.

For surface mounting 230 V / 3 ph.

Type ESU 1 Ref. no. 0236

Max. load 1 A
Type ESU 3 Ref. no. 0237
 Max. load 2.5 A (T 40 E)
 White polymer casing. Installation
 Operation display via illuminated
 ring.
 Minimum current 0.15 A
 Protection to (installed) IP 30
 Wiring diagram no. SS-556.1
 Dimensions mm W 80 x H 80 x D 21 protr.



Type ESU 5 Ref. no. 1296

Max. load 5 A (T 40 E)
 (for install. in lightweight walls 4 A)
 White polymer casing. The double-
 box required for flush mounting is
 included in the scope of delivery.
 Minimum current 0.2 A
 Protection to IP 20
 Wiring diagram no. SS-165
 Dimensions mm W 81 x H 152 x D 40



For surface mounting 230 V / 1 ph.

Type ESA 1 Ref. no. 0238

Max. load 1 A
Type ESA 3 Ref. no. 0239
 Max. load 2.5 A (T 40 E)
 White polymer casing.
 Operation display via illuminated
 ring in control knob.
 Minimum current 0.15 A
 Protection to IP 40
 Wiring diagram no. SS-556.1
 Dimensions mm W 80 x H 80 x D 65



Type ESA 5 Ref. no. 1299

Max. load 5 A (T 40 E)
 Light grey polymer casing, facia
 plate anodised aluminium.
 Minimum current 0.2 A
 Protection to IP 44
 Wiring diagram no. SS-165
 Dimensions mm W 84 x H 170 x D 40



For surface mounting, with reversing switch 230 V / 1 ph.

Suitable for fan models:
 HVR 150/2 RE, REW 150
 and 200, range HV.
 H 200/4 and 250/4 and
 window fans GX.

Type BSX Ref. no. 0240

Max. load 1 A (T 40 E)
 Surface mounted speed controller
 with reversing switch for reversible
 fans (intake/extract) in a white
 polymer casing. Only suitable
 for fans, that are reversible via
 reversing switch.
 Minimum current 0.15 A
 Protection to IP 40
 Wiring diagram no. SS-480.2
 Dimensions mm W 80 x H 80 x D 65



For fuse board installation 230 V / 1 ph.

Type ESE 2.5 Ref. no. 1302

Max. load 2.5 A (T 40 E)
 For installation in fuse boards
 (35 mm standard buzzbar profile
 and for 68 mm built-in range).
 Minimum current 0.1 A
 Protection to IP 20
 Wiring diagram no. SS-376
 Dimensions mm W 50 x H 85 x D 60
 (there from 10 mm protruding)



■ **Five step transformer speed controller for speed controlling of 1 ph. alternating current fans**

- Suitable for power control of all speed controllable 1 ph. alternating current fans.
- Four secondary voltages stepped in 80 / 100 / 130 / 170 and 230 V (full mains voltage) allow to control 5 fan speeds.
- A number of different fans can be connected to one controller up to its nominal load.

■ **Advantages**

- Good cost effectiveness.
- Reliable.
- Low loss and low noise fan operation.
- MWS-, TSW- (from the model TSW 1.5) and STSSW models with full power output for connection with the signal lamp or shutter.

■ **Design for surface mounting units**

- Robust ISO casing, light grey, made of impact resistant polymer. Protection to IP 54.
- Built-in operating switch for five speed steps and on/off function.
- Operation display via control lamp.
- Fully impregnated transformers T 40 E.
- Conforms to DIN VDE 0550.
- Max. permitted ambient temperature +40 °C.
- Delivered ready for installation, simple connection to terminal block.

■ **Design for built-in transformers**

- Built-up terminal block for five voltage outputs.
- Attached fixing brackets for simple fixture.
- Fully impregnated transformers T 40 E.

□ **Accessories**

Six step cam switch, model STSSW for switch board installation, with front mounting plate.

**For surface mounting
Max. load 0.35 A
1 ph. alternating current, 230 V**

**For surface mounting
1 ph. alternating current, 230 V**

**For switchboard installation
1 ph. alternating current, 230 V**

**With motor full protection facility
1 ph. alternating current, 230 V
For surface mounting**

Mini speed controller TSW 0.3
Compact five step speed controller with on/off switch for surface mounting in dry rooms. Polymer casing, white.

Type TSW 0.3 **Ref. no. 3608**
max. load 0.35 A
Protection to IP 20
Dimensions mm W 160 x H 85 x D 60
Wiring diagram no. SS-496.1



Transformer speed contr. TSW
For one or more alternating current fans.

Type	Ref. no.	I max. A	Dim. in mm		
			B	H	T
TSW 1.5¹⁾	1495	1.5	154	200	79
TSW 3.0¹⁾	1496	3.0	154	200	148
TSW 5.0²⁾	1497	5.0	200	254	167
TSW 7.5²⁾	1596	7.5	200	254	167
TSW 10²⁾	1498	10.0	200	254	167

Wiring diagram no. ¹⁾ SS-960 ²⁾ SS-437.1



Speed control transformer TSSW

Built-in transformer with rail and terminals for 5 output voltages.

Type	Ref. no.	I max. A	Dim. in mm		
			B	H	T
TSSW 1.5	6520	1.5	78	90	78
TSSW 3	6521	3.0	84	94	92
TSSW 5	6522	5.0	105	111	87
TSSW 10	6523	10.0	120	122	112

Wiring diagram no. SS-268

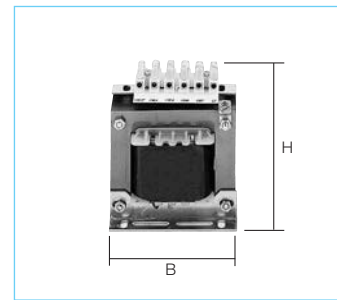

Five step operating switch STSSW Accessory for control transformer TSSW for 230 V, 1 ph. fans. For switchboard installation with front fixing and front panel. Connections are deepened.

Type STSSW **Ref. no. 0234**
Voltage AC 3, 230 V
max. load 2,2 kW
Installation depth 70 mm, □ 46 mm
Wiring diagram no. SS-548



Transformer speed controller MWS with motor full protection facility

Five step speed controller with integrated tripping unit for 230 V, 1 ph. fans.

To connect thermal contacts wired to the terminal box. A number of fans can be controlled up to the nominal load.

If a thermal contact trips all fans will be disconnected. Step switch and control lamp included. Restarting via "0" position after interference or power cut off.



Type	Ref. no.	I max. A	Casing IP 54 made of	Dimensions in mm			Weight kg
				W	H	D	
MWS 1.5	1947	1.5	Polymer	200	254	98	3.0
MWS 3	1948	3.0	Polymer	200	254	98	4.0
MWS 5	1949	5.0	Polymer	200	254	167	5,3
MWS 7.5	1950	7.5	Polymer	236	316	188	10.0
MWS 10	1946	10.0	Polymer	236	316	188	13.5

Connection according to wiring diagram no. SS-440.4

■ Five step transformer speed controller for speed controlling of 3 ph. alternating current fans

□ Suitable for speed control of all speed controllable 3 ph. alternating current fans, for Y/Δ reversible switching models in higher steps.

□ Four secondary voltages stepped in 80 / (115)* / 140 / 200 / 280 and 400 V (full mains voltage) allow to control 5 fan speeds.

* On TSD internally adjustable for voltage controllable, explosion proof in-duct and roof fans.

□ A number of different fans can be connected to one controller up to its nominal load.

■ Advantages

- Good cost effectiveness.
- Reliable.
- Low loss and low noise fan operation.
- RDS-, TSD- and STSSD models with full power output for connection with the signal lamp or shutter.

■ Design for surface mounting units

- Robust ISO casing, light grey, made of impact resistant polymer. Protection to IP 54. Models from RDS 7 and TSD 5.5 made of steel, double painted, protection to IP 65.
- Built-in operating switch for five speed steps and on/off function.
- Operation display via control lamp.
- Fully impregnated transformers T 40 E, protection class II.
- Conforms to DIN VDE 0550.
- Max. permitted ambient temperature +40 °C.
- Delivered ready for installation, simple connection to terminal block.

■ Design for built-in transformers

- Two transformers in V switching ensure the functions as described above.
- Built-up terminal block for five voltage outputs.
- Attached fixing brackets for simple fixture.
- Fully impregnated transformers T 40 E.
- Contactors and external wiring to be supplied onsite.

□ Accessories

Five step switch STSSD for fuse board installation, with front board.

**For surface mounting
3 ph. alternating current, 400 V**

**For switchboard installation
3 ph. alternating current, 400 V**

**With motor full protection facility
3 ph. alternating current, 400 V
For surface mounting**

Speed control transformer TSD

As TSW, but for 3 phase fans.

Type	Ref. no.	I max. A	Dim. in mm		
			W	H	D
TSD 0.8	1500	0.8	200	254	167
TSD 1.5	1501	1.5	200	254	167
TSD 3.0	1502	3.0	200	254	167
TSD 5.5	1503	5.5	300	300	150
TSD 7.0	1504	7.0	300	300	150
TSD 11.0	1513	11.0	300	400	200

Wiring diagram no. SS-436.2



Speed control transformer TSSD

As TSSW, but two transformers without casing, in V switching.

Type	Ref. no.	I max. A	Dim. in mm		
			W	H	D
TSSD 1	6516	1.0	84	95	80
TSSD 2	6517	2.0	96	104	92
TSSD 4	6518	4.0	105	112	98
TSSD 7	6519	7.0	120	122	134
TSSD 11	6515	11.0	150	146	158

Wiring diagram no. SS-267.1

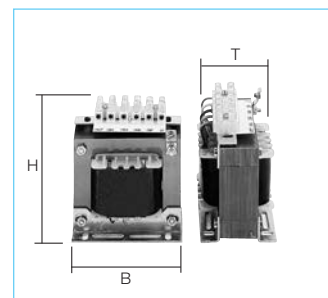

5 step operating switch STSSD

Suitable for control of transformer TSSD for 400 V, 3 ph. fans. For switchboard installation with front fixing and front panel. Connections are deepened.

Type STSSD Ref. no. 0235

Voltage AC 3, 400 V
max. load 5.5 kW
Installation depth 110 mm, □ 46 mm
Wiring diagram no. SS-549.1

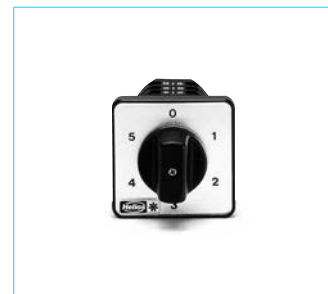

Transformer speed controller RDS with motor full protection facility

Five step speed controller with integrated thermal contact tripping unit for 400 V, 3 ph. alternating current fans.

To connect thermal contacts wired to the terminal box. A number of fans can be controlled up to the nominal load.

If a thermal contact trips all fans will be disconnected.

Step switch and control lamp included. Restarting via "0" position after interference or power cut off.



Type	Ref. no.	I max. A	Casing IP 54 made from	Dimensions in mm			Weight kg
				W	H	D	
RDS 1	1314	1.0	Polymer	236	316	128	6.0
RDS 2	1315	2.0	Polymer	236	316	128	9.7
RDS 4	1316	4.0	Polymer	236	316	128	10.5
RDS 7	1578	7.0	Steel	300	300	150	21.0
RDS 11	1332	11.0	Steel	300	400	200	26.0

Designed to comply with VDE 0550, fully impregnated transformers in V switching. Max. permitted ambient temperature +40 °C. Wiring diagram no. SS-139.

■ **Five-step climate transformer controller KTRW and KTRD**

- Trouble-free, low-loss transformer controller for temperature-dependent fan control including full motor protection.
- Recommended for noise critical applications.
- Control via an electronic thermostat type TME 4 or EST to be ordered separately as accessory.

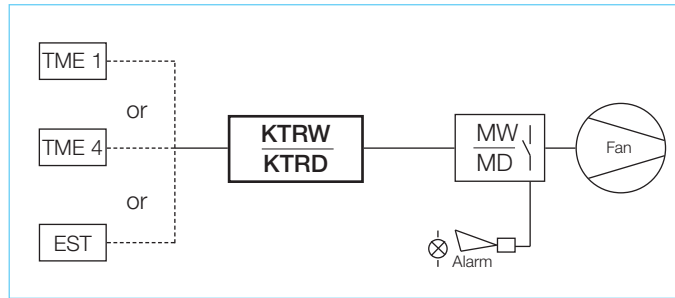

For single phase fans
1 ph., 230 V, 50/60 Hz

Climate transformer controller KTRW 230 V

For automatic control of one or several 1 ph. fans in relation to the room temperature. Five-step automatic operation, whereby each step can also be switched manually. Integrated full motor protection by connecting the thermal contacts on the motor. Suitable for stable ventilation. Light grey polymer casing.

Type	Ref. no.	I max.	Dim. in mm		
			A	B	H T
KTRW 3	1662	3	236	316	128
Voltage		230 V~, 50/60 Hz			
Protection class		IP 54			
Max. ambient temperature		+40 °C			
Wiring diagram no.		SS-674			



For three phase fans
3 ph., 400 V, 50/60 Hz

Climate transformer controller KTRD 400 V

For automatic control of five step 3 ph. fans in relation to the room temperature. The built-in operating switch also allows manual control. Integrated full motor protection by connecting the thermal contacts on the motor. Robust casing made of steel, dual coating in light grey.

Type	Ref. no.	I max.	Dim. in mm		
			A	B	H T
KTRD 3	1650	3	300	500	200
KTRD 5.5	1651	5.5	300	500	200
KTRD 10	1652	10	400	500	200
KTRD 15	1653	15	400	500	200
Voltage		400 V, 3~, 50/60 Hz			
Protection class		IP 54			
Max. ambient temperature		+40 °C			
Wiring diagram no.		SS-676.1			



■ **Accessories for KTRW and KTRD**

Four-step electronic thermostat

For temperature-dependent control of a KTR transformer controller or for on/off operation of up to four single phase fans. (Supply voltage 230 V required.)

Electronic four step thermostat with a switching sequence of 1 K for adjusted setpoint. Enables five step temperature-controlled fan operation in combination with the climate controller KTR in relation to the pre-set setpoint and actual temperatures. Robust casing made of impact-resistant, light grey polymer. Cable entry at the bottom of the casing in PG 11.

Type	Ref. no.	1335
Voltage		230 V~, 50/60 Hz
Max. continuous current (AC 3)		6 A
Temperature range		0 to +50 °C
Switching precision		+/- 0.8 K at 20 °C
Switching distance		1 K
Protection category		II
Protection class		IP 54
Dim. mm		W 120 x H 80 x D 75
Weight approx.		0.4 kg
Wiring diagram no.		SS-702



Electronic control thermostat EST

with various control variables to control a climate transformer controller KTR.

Control functions

- Temperature dependent, five-step fan control via KTR units. Limitation of control range possible by selecting a minimum and maximum air rate (voltage). Minimum air rate can be switched on and off.
- Ventilation damper control (analogue 0...10 V)
- Control of a frequency inverter (analogue 0...10 V)
- Heating thermostat
- Temperature monitor (insufficient and excessive temperatures with outside air temperature compensation).
- Adjustments made via a dirt-resistant membrane keypad.

□ **Displays**

- Displays for operation mode, room temperature, outside temperature and adjusted setpoint temperature.
- Signal LED for soft-closing mechanism.
- Alarm signal LED for insufficient, excessive temp., system error.
- Scaled LED display (0-100 %) for fan speed and opening of shutter.

□ **Temperature sensor**

An outside and an inside temperature sensors are included as standard. Casing protected to IP 55, installation up to 100 m distance from controller, connection by means of NYM 3 x 1.5 mm².

□ **Possible settings**

- Stepless specification of setpoint temp. and control range.
- Min. / max. power (speed) limit.
- Min. air flow vol. can be on/off.
- Soft-closing mechanism on/off.

Type EST Ref. no. 1355

Voltage		230 V, 1~, 50/60 Hz
Protection class		IP 54
Transf. connection		230 V AC / max. 10 A
Temperature range (adjustable)		0 - 40 °C
Control range (adjustable)		2 - 12 K
Alarm low temp. (adjustable)		-20 - 0 K
Alarm high temp. (adjustable)		0 - 25 K
Heating (adjustable)		-15 - +5 K
Outside temp. compensation		0 - 20 K
Min. air rate approx.		0 - 40 %
Max. air rate approx.		60 - 100 %
Disable minimum air speed		-25 - 0 K
Dim. mm		W 260 x H 215 x D 120
Weight approx.		2.0 kg
Wiring diagram no.		SS-357.3



- Stepless temperature specification for activation of heating.
- Stepless specification for alarm signal for low and high temperatures.
- Min. and max. shutter opening.

■ **Casing**

Polymer, light grey with transparent hinged lid, for surface installation.

ESD



With these speed controllers, Helios offers a simple solution by connecting the fans and central building management systems specified by the customer!

Common features

- Control via analogue 0–10 V on-site input signal, electronic control system EUR 6 C or other controllers.
- A number of different fans can be controlled by one controller up to its maximum load.
- Several controllers can be controlled in parallel by a central building management system that allows the ventilation to be distributed to several fans or fan units and therefore in several circuits.

Accessories for both series

An universal control unit with 10 V output can be used if the fans are not controlled by a central building management system.

Type EUR 6 C Ref. no. 1321
See electronic control system page for description.

Model range

Type	Ref. no.	Output current	Power consumption	Wiring diagram	Dimensions			Cooling element width	Weight	Protection to
					H	W	D			
					mm	mm	mm	mm	kg	IP
For three phase fans, 3~, 400 V, 50/60 Hz										
ESD 5	0501	5.0	2.2	831	160	115	165	23	1.5	65
ESD 11.5	0502	11.5	5.5	831	160	160	165	68	1.7	65

ETW



Specification ETW

Seven-step electronic transformer control unit for speed control of 1 ph. fans. Robust and low-loss power units for ventilation systems controlled by central building management systems.

Possible settings / Display

- Built-in operating switch allows on, off and direct supply switching.
- Power step rotary switch allows manual operation of steps (1–7) or automatic operation. In “auto” mode, the transformer control unit is automatically controlled by the on-site ventilation control.
- The operating step is displayed by a LED.
- The built-in minimum air volume switch can be totally switched off from the ventilation controller via the analogue input.

Overload protection

ETW types are protected against permanent overload by a built-in temperature switch. When the overload protection trips, the unit switches automatically to direct supply. After cooling down, the unit switches back to normal operation. The interference can or should be signalled via the output to an on-site alarm system.

Casing

- Polymer casing, light grey.

Dimensions

Type	Dim. in mm			Weight kg
	H	W	D	
ETW 5	315	240	210	8
ETW 10	315	240	210	10

Model range

Type	Ref. no.	Output current	Output voltages Step							Wiring diagram	Protection to
			1	2	3	4	5	6	7		
		A	V							No.	IP
For single phase fans, 1~, 230 V, 50/60 Hz											
ETW 5	1263	5.0	80	95	115	135	165	195	230	683	54
ETW 10	1264	10.0	80	95	115	135	165	195	230	683	54

FU-B and FU-BS



FU-C and FU-CS

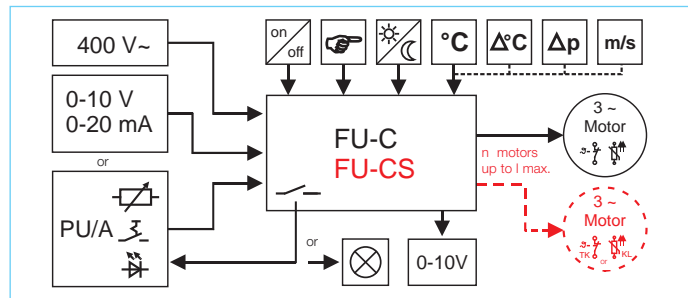
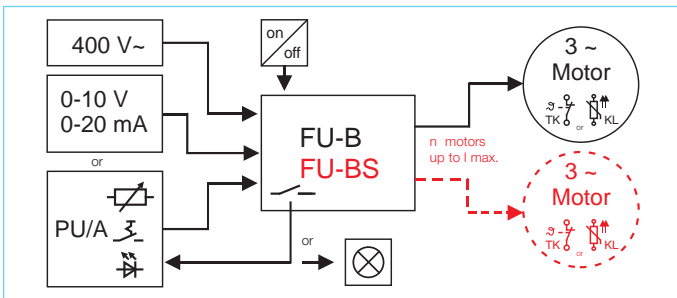

**■ Specification
FU-B “Basic”**

- Frequency inverter FU-B in basic design without sine filter to control the speed of a single fan.
- Speed specified by a 0-10 V control signal (e.g. potentiometer PU/PA, accessories).
- Maximum line length between FU-B and fan 10 m with shielded lines.
- The fan must be designed for operation with a frequency inverter (suitable EMC fan / motor, possibly with a special design).
- The FU-B is fixed to its nominal current.
- For FU-B operation (without sine filter), the suitability for the frequency inverter must be stated when ordering the fan.

**■ Specification
FU-BS “Basic-Sine”**

- Frequency inverter FU-BS in basic design with built-in sine filter effective on all poles.
- To control the speed of one or more fans. The permitted number of fans is calculated from the maximum FU current.
- The speed is specified by a 0-10 V control signal (e.g. potentiometer PU/PA, accessories).
- Line lengths between FU-BS and fan greater than 10 m are possible.
- No additional EMC shielding of the electrical lines required. The fans, including motor, do not require any specific EMC precautions to operate the frequency inverter.
- The FU-BS is fixed to its nominal current.
- When using the frequency inverter with a built-in sine filter, conventional standard fans / motors can be used.

**■ Specification
FU-C “Comfort”**

- Frequency inverter FU-C in comfort design without sine filter to control the speed of a single fan.
- Includes display and three buttons to set the fan and control parameters.
- Parameters can be set and unit can be controlled via modbus.
- With built-in, fully-fledged control system for temperature, pressure and air speed. The required sensors LDF 500, LGF 10, LT.. can be delivered as accessories (see page EUR 6 C).
- Speed specified by a 0-10 V control signal (e.g. potentiometer PU/PA, accessories) or direct entry on the display.
- Line length and suitability of the fan for operation with frequency inverter, see FU-B description.
- For FU-C operation (without sine filter), the suitability for the frequency inverter must be stated when ordering the fan.

**■ Specification
FU-CS “Comfort-Sine”**

- Frequency inverter FU-CS in comfort design with built-in sine filter effective on all poles.
- To control the speed of one or more fans. The permitted number of fans is calculated from the maximum FU current.
- Includes display and three buttons to set the fan and control parameters.
- Parameters can be set and unit can be controlled via modbus.
- With built-in, fully-fledged control system for temperature, pressure and air speed. The required sensors LDF 500, LGF 10, LT.. can be delivered as accessories (see page EUR 6 C).
- See FU-BS description for speed specification, line length, EMC precautions.
- When using the frequency inverter with a built-in sine filter, conventional standard fans / motors can be used.

	FU-B and FU-BS
Analogue inputs	1 x 0-10 V, Ri 100 kOhm or 0-20 mA
Logic inputs	1 x digital 24 V, release
Analogue output	—
Relay output	1 x closing contact 250 V / 2 A ind.
Power supply for modules	1 x 10 V DC, 10 mA, 1 x 24 V DC, 70 mA
Motor temp. monitoring	Thermal contact or PTC thermistor

	FU-C and FU-CS
Analogue inputs	2 x 0-10 V, Ri 100 kOhm or 0-20 mA, or KTY
Logic inputs	2 x digital 24 V, function parametrisable
Analogue output	1 x 0-10 V DC, 10 mA
Relay output	2 x changeover contact 250 V / 2 A ind.
Power supply for modules	1 x 10 V DC, 10 mA (in analogue output), 1 x 24 V DC, 70 mA
Motor temp. monitoring	Thermal contact or PTC thermistor

General properties

- Inverter specially designed for HLK use.
- Saves energy thanks to stepless speed adjustments.
- Specially tailored to the fan motor, i.e. minimal energy consumption and noise in partial load operations.
- Use of zero-maintenance alternating current asynchronous motors with all construction designs and powers.
- No power restriction when using standard motors.
- Operating notification via potential-free contact.
- Potentiometer voltage supply: E.g. 10 V DC / 10 mA for potentiometer with 10 kOhm
- Analogue input for speed specification (0-10 V, 0(4)-20 mA).
- Short-circ.-proof and grounded.
- Built-in electronic motor protection via thermal contacts or PTC thermistors.
- Electrically isolated control unit.
- Overvoltage protection
- Also suitable for installation into a control cabinet.
- At amb. temp. of 40 °C – 55 °C, consider a loss of performance.

Type-based properties

- Basic types:
- Additional voltage supply: 24 V DC / 70 mA for wiring digital inputs and additional external components.
- Sine types:
- Includes internal sine filter effective on all poles.
 - For the simple, subsequent enhancement of existing ventilation systems.
- Comfort types:
- Free specification of the acceleration and delay times to reduce noise on start-up.
 - Additional voltage supply: 24 V DC / 120 mA for wiring digital inputs and additional external components.
 - Easy to adjust and control values using the display
 - Extensive diagnostic display in case of an error.
 - Speed specification directly on the device via the display.
 - Serial interface RS 485 / Modbus-RTU.
 - Adjustment of performance according to needs and configurable parameters.

Information

- Internal sine filter effective on all poles** (types FU-..S)
Filters the voltages between the individual phases and string voltage between phase and protective conductor. Thus the output voltage of the frequency inverter is purely sinusoidal and matches the quality of a standard mains voltage.
- Ground fault circuit interrupters** (all types)
When using the frequency inverter in an environment that requires a ground fault circuit interrupter, this must match type B+, 300 mA sensitive to universal currents.
- EMC**
All FU types comply with the EMC Dir. 2004/108/EG and the applicable standards such as DIN EN 60335-1 and DIN EN 550011. Radio interference filters are built in to ensure cl. B (res. area). For FU-B and FU-C, the line between the fan and frequency inverter must be shielded and must be no more than 10 m long. Motor supply/temp. monitoring lines laid separately.

Design motor current / frequency

When selecting the right frequency inverter, the maximum motor current is to be used as a starting point. When operating multiple fans, the sum of the individual currents is to be used. To prevent faults and failures, a 10% reserve should be included in the plans. A maximum frequency of 50 Hz must not be exceeded when controlling the speed of a series fan, as otherwise the motor will be overloaded and broken. A higher-frequency operation is only possible upon request.

Motor protection

Maximum motor protection is achieved through monitoring (thermal contacts / PTC thermistors); a maximum of 6 PTC thermistors can be connected to the device in series. It is possible to increase the number of PTC thermistors by using monitoring devices (type MSA, accessories).

Accessories for all FU types

PW 24 / PA 24 No. 1736/1737
Speed potentiometer, flush / surface, LED 24 V, Poti 10 V / 1.3-10 V

SU-3 10 / SA-3 10 No. 4266/4267
Three-step speed switch, flush / surface, 10 V / 1.7-10 V

Type WSUP Ref. no. 9990
Week timer with LCD-display, potential-free contact

Type WSUP-S Ref. no. 9577
Week timer potential-free contact, for DIN rails

Type EDR Ref. no. 1437
Electronic differential pressure controller 0-1000 Pa, 10-24 V / 0-10 V

Type ETR Ref. no. 1438
Electronic temperature controller (sensor see accessory ETR)

Type EUR EC Ref. no. 1347
Electronic universal controller (sensor see accessory EUR EC)

Type MSA Ref. no. 1289
Full motor protection for PTC thermistor

General technical data

Mains voltage 3~, 208 – 480 V
Mains frequency 50/60 Hz
Output voltage 95 % of U_{mains}
Output frequency 50 Hz
Protection class IP 54
Ambient temperature 0 to +40 °C
(–20 °C not currentless)

Type	Ref. no.	Max. power		Cable cross section from mains to motor cable	Wiring diagram	Dimensions			Weight net approx.	
		Output current	Motor			Height	Width	Depth		
		A	kW	mm ²	No.	mm	mm	mm	kg	
Basic design without sine filter for 3 ph. AC fans, 400 V, 50/60 Hz, protection to IP 54										
FU-B 3.6	5453	3.6	1.5	4 x 1.5 ¹⁾	1020	284	240	115	2.6	
FU-B 5.0	5454	5.0	2.2	4 x 1.5 ¹⁾	1020	302	250	196	4.6	
FU-B 7.0	5455	7.0	3.0	4 x 1.5 ¹⁾	1020	302	250	196	4.7	
FU-B 8.5	5456	8.5	4.0	4 x 1.5 ¹⁾	1020	302	250	196	5.6	
FU-B 12	5457	12.0	5.5	4 x 1.5 ¹⁾	1020	302	250	196	5.7	
FU-B 17	5458	17.0	7.5	4 x 1.5 ¹⁾	1020	302	250	196	5.9	
Basic design with all-pole sine filter for 3 ph. AC fans, 400 V, 50/60 Hz, protection to IP 54										
FU-BS 2.5	5459	2.5	2) ²⁾	4 x 1.5	1028	284	240	115	2.7	
FU-BS 5.0	5460	5.0	2) ²⁾	4 x 1.5	1028	302	250	196	5.2	
FU-BS 8.0	5461	8.0	2) ²⁾	4 x 1.5	1028	302	250	196	6.3	
FU-BS 10	5462	10.0	2) ²⁾	4 x 1.5	1028	302	250	196	6.8	
FU-BS 14	5463	14.0	2) ²⁾	4 x 1.5	1028	302	250	196	6.9	
Comfort design without sine filter for 3 ph. AC fans, 400 V, 50/60 Hz, protection to IP 54										
FU-C 4.2	5865	4.2	1.5	4 x 1.5 ¹⁾	1030	302	250	195.5	6.4	
FU-C 8.5	5868	8.5	4.0	4 x 1.5 ¹⁾	1030	302	250	195.5	7.3	
FU-C 12	5869	12.0	5.5	4 x 1.5 ¹⁾	1030	302	250	195.5	7.5	
FU-C 17	5870	17.0	7.5	4 x 2.5 ¹⁾	1030	302	250	195.5	7.5	
FU-C 25	5464	25.0	11	5 x 4.0 ¹⁾	1030	355	280	239	12.5	
FU-C 32	5465	32.0	15	4 x 6.0 ¹⁾	1030	524	386	283	24.5	
FU-C 39	5466	39.0	18.5	4 x 10.0 ¹⁾	1030	524	386	283	26.3	
FU-C 46	5467	46.0	22	4 x 10.0 ¹⁾	1030	524	386	283	26.3	
FU-C 62	5468	62.0	30	4 x 16.0 ¹⁾	1030	524	386	283	26.3	
Comfort design with all-pole sine filter for 3 ph. AC fans, 400 V, 50/60 Hz, protection to IP 54										
FU-CS 2.5	5871	2.5	2) ²⁾	4 x 1.5	1032	284	240	115	3.3	
FU-CS 8	5873	8.0	2) ²⁾	4 x 1.5	1032	302	250	195.5	7.9	
FU-CS 10	5874	10.0	2) ²⁾	4 x 1.5	1032	302	250	195.5	8.2	
FU-CS 14	5875	14.0	2) ²⁾	4 x 1.5	1032	302	250	195.5	8.7	
FU-CS 18	5469	18.0	2) ²⁾	4 x 2.5	1032	302	250	196	9.1	
FU-CS 22	5470	22.0	2) ²⁾	5 x 4.0	1032	355	280	239	14.5	
FU-CS 32	5471	32.0	2) ²⁾	4 x 6.0	1032	525	386	283	29.6	
FU-CS 40	5472	40.0	2) ²⁾	4 x 10.0	1032	525	386	283	29.6	
FU-CS 50	5473	50.0	2) ²⁾	4 x 16.0	1032	525	386	283	32.8	

¹⁾ max. 10 m shielded, motor supply and motor protection laid separately

²⁾ The max. current for all connected fans is decisive for design

■ **Universal controller EUR 6 C**
Electronic control unit with power supply unit on the phase control principle.

□ **Area of application**

For control of central ventilation systems or for stepless control of one or more speed controllable 1 ph. fans.
In domestic, commercial, industrial and agricultural applications.

□ **Control functions**

Simple and quick start-up of parameters via integrated "startup wizard". Depending on the connected sensor a control can be carried out according to following control variables:

- **Manual speed control**, e.g. adjustable via keyboard
- **Temperature** (required accessory temperature sensor LTR 40 or LTK 40)
- **Temperature with additional functions** pre-programmed, (required accessory temperature sensor LTR 40 or LTK 40)
- **Differential temperature control** (required accessory temperature sensor LTR 40 or LTK 40)
- **Differential pressure** (required accessory differential air pressure sensor LDF 500)
- **Differential pressure with outside air temperature compensation** (required accessory differential air pressure and temperature sensor LDF 500 and LTR 40 or LTK 40). Ideal for central ventilation systems according to DIN 18017 in residential construction.
- **Air velocity** (required accessory air velocity sensor LGF 10)

The required sensor is to be ordered separately as an accessory. The control ranges are freely adjustable within the sensor's range.

The aligned output voltage according to nominal value and current value is between 0 % (35 V) to 100 % (approx. 80 V – 230 V). The specification of minimum and maximum values is possible.

- Main switch with positions:
"0" = Controller off
"I" = Automatic operation
"230 V" = uncontrolled direct supply.

Inputs and outputs:

Outputs:

- 1 x motor connection based on phase control principle
- 1 x analogue output 0–10 V for control of e.g. frequency inverter, shutter, EC motor.
- 2 x potential-free relay, programmable, alarm, heating or status signals

EUR 6 C



Inputs:

- 2 x sensor inputs, programmable on the respective necessary sensor type
 - Connection of thermal contacts for motor protection
- The whole system stops when a thermal contact TK trips. It must be restarted manually once the motor has cooled down.
- 2 x digital inputs, programmable for release, external interference, limit on/off, switching night reduction, internal/external, control/manual operation, reset, max. speed on/off

Possible settings

- Stepless selection of setpoints and control range
- Min./max. power (speed) limit
- On/off switching of minimum air flow volume
- Switching e.g. heating via programmable relay
- Stepless selection for alarm indication at low and high temperature, output on display or additionally on relay
- Min. and max. shutter opening
- Reverse control functions
- Continuous control of ventilation dampers
- Adjustments made via a dirt-resistant membrane keypad.

□ **Display**

- Multi-function LC display
- Numerical setpoint and actual value display with scale
- Symbols (alarm, heating, release)
- Bar graph/level indicator
- Text display for menu, status and fault indications

Mode 2.03: Temperature control with additional function
Mode 2.05: Differential temperature control

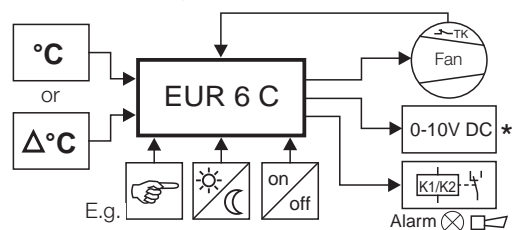

* e.g. for shutter, frequency inverter

Mode 4.01: Differential pressure control
Mode 6.01: Air velocity control

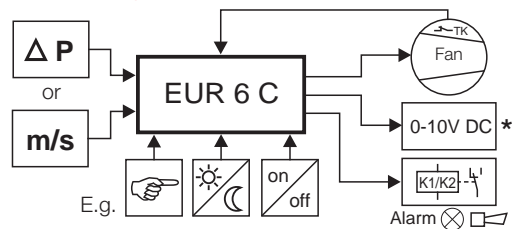

* e.g. for shutter, frequency inverter

Type EUR 6 C Ref. no. 1321

Voltage	230 V~, 50/60 Hz
max. current	6 A
Required minimum current	0.2 A
Controlled output voltage	0 – 100 %
Control range temperature	0 – 40 °C
Control range pressure	0 – 500 Pa
Control range velocity	0 – 10 m/s
Permitted ambient temp.	0 to +40 °C
Protection class	IP 54
Casing	surface mounted installation, polymer, light grey
Dim. mm	W 223 x H 200 x D 131
Weight	approx. 1.4 kg
Wiring diagram no.	SS-911

■ **Necessary accessories**

Type LDF 500 Ref. no. 1322
Differential air pressure sensor
Range 0 – 500 Pa

Type LGF 10 Ref. no. 1325
Air velocity sensor
Range 0 – 10 m/s

Type LTA 40 Ref. no. 1336
Temperature sensor for outside
Range –20 to +60 °C
Protection class IP 54

Type LTK 40 Ref. no. 1324
Temperature sensor for duct installation
Range 0 to +40 °C

Type LTR 40 Ref. no. 1323
Room temperature sensor
Range 0.5 to +40 °C

■ **Note**

Electronic speed controllers may produce motor humming. Transformer controllers are to be used for noise critical applications.

EUR EC



■ **Universal control system EUR EC**
Electronic control unit with 0–10 V DC control output.

□ **Area of application**
For stepless control or regulation of single and three phase EC fans with a setpoint input of 0–10 V DC.

□ **Control functions**
Simple and quick start-up of parameters via integrated “startup wizard”. Depending on the connected sensor a control can be carried out according to following control variables:

- **Manual speed control**, e.g. adjustable via keyboard
- **Temperature** (required accessory temperature sensor LTR 40 or LTK 40)
- **Temperature with additional functions** pre-programmed, (required accessory temperature sensor LTR 40 or LTK 40)
- **Differential temperature control** (required accessory temperature sensor LTR 40 or LTK 40)
- **Differential pressure** (required accessory differential air pressure sensor LDF 500)
- **Differential pressure with outside air temperature compensation** (required accessory differential air pressure and temperature sensor LDF 500 and LTR 40 or LTK 40). Ideal for central ventilation systems according to DIN 18017 in residential construction.
- **Air velocity** (required accessory air velocity sensor LGF 10)

The required sensor is to be ordered separately as an accessory. The control ranges are freely adjustable within the sensor's range.

The aligned output voltage according to nominal value and current value is between 0 % (0 V DC) to 100 % (10 V DC). The specification of minimum and maximum values is possible.

Inputs and outputs:

Outputs:

- 2 x analogue outputs 0–10 V to control e.g. EC motor, frequency inverter, shutter
- 2 x potential-free relay, programmable, alarm, heating or status signals

Inputs:

- 2 x sensor inputs, programmable on the respective necessary sensor type
- 3 x digital inputs, programmable ro release, external interference, limit on/off, switching night reduction, internal/external, control/manual operation, reset, max. speed on/off

Possible settings

- Stepless selection of setpoints and control range
- Min./max. power (speed) limit
- On/off switching of minimum air flow volume
- Switching e.g. heating via programmable relay
- Stepless selection for alarm indication at low and high temperature, output on display or additionally on relay
- Min. and max. shutter opening
- Reverse control functions
- Continuous control of ventilation dampers
- Adjustments made via a dirt-resistant membrane keypad.

Display

- Multi-function LC display
- Numerical setpoint and actual value display with scale
- Symbols (alarm, heating, release)
- Bar graph/level indicator
- Text display for menu, status and fault indications

Note

Depending on the fan type to be connected, multiple fans can be connected in parallel to an EUR EC.

Mode 2.03: Temperature control with additional function
Mode 2.05: Differential temperature control

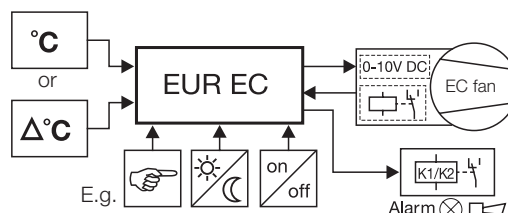

Mode 4.01: Differential pressure control
Mode 6.01: Air velocity control

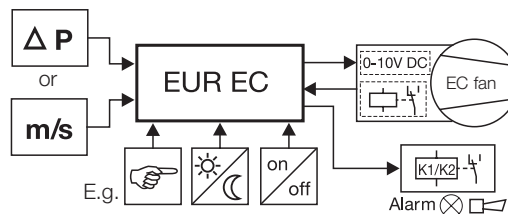

Type EUR EC Ref. no. 1347

Voltage	230 V~, 50/60 Hz
Control output	0–10 V / max. 10 mA
Controlled output voltage	0 – 100 %
Control range temperature	0 – 40 °C
Control range pressure	0 – 500 Pa
Control range velocity	0 – 10 m/s
Permitted ambient temp.	0 to +40 °C
Protection class	IP 54
Casing	surface mounted installation, polymer, light grey
Dim. mm	W 223 x H 200 x D 131
Weight	approx. 1.0 kg
Wiring diagram no.	SS-1001

■ Necessary accessories

Type LDF 500 Ref. no. 1322

Differential air pressure sensor
Range 0 – 500 Pa

Type LGF 10 Ref. no. 1325

Air velocity sensor
Range 0 – 10 m/s

Type LTA 40 Ref. no. 1336

Temperature sensor for outside
Range –20 to +60 °C
Protection class IP 54

Type LTK 40 Ref. no. 1324

Temperature sensor for duct
installation
Range 0 to +40 °C

Type LTR 40 Ref. no. 1323

Room temperature sensor
Range 0.5 to +40 °C

EDR



■ **Electronic controller for differential pressure or temperature**

□ **Area of application**

For stepless control of 1 ph. and 3 ph. EC fans or frequency inverters with a setpoint input of 0-10 V DC. If the EC fan or frequency inverter provides a supply voltage of 10-24 V DC/6 mA (safety extra-low voltage), the controller can be directly powered or alternatively via a power supply unit (NG 24, accessories).

□ **Display**

- Multi-function LCD display
- Numerical setpoint and actual value display with measurement unit
- Alarm, day/night mode
- Text display for menu, status

□ **Control functions**

Simple and quick start-up of parameters using LCD display and three internal input keys. Permanent measurement display on LCD display.
Optional parameterisation as
– **regulator** = 0-10 V analogue output proportional to the measured actual value as control variable for external controls or as
– **controller** = controlled 0-10 V analogue output in relation to the set setpoint value and the measured actual value.
The controlled output voltage between the actual and setpoint value lies between 0 % (0 V DC) and 100 % (10 V DC). The specification of min. and max. values is possible, two setpoint values (e.g. for day/night mode) are also adjustable. Switching by means of week timer (types WSUP, WSUP-S, see accessories).

■ **Differential pressure controller EDR**

With firmly integrated pressure sensor and connections for pressure hoses (DN 5 mm, on-site).

- Adjustable pressure ranges:
0-1000 Pa, 0-500 Pa, 0-300 Pa, 0-200 Pa

Type EDR	Ref. no. 1437
Supply voltage	10-24 V DC, 6 mA
Analogue outputs	0-10 V DC 10 V / 0.3 mA 24 V / 10 mA
Signal input	10-24 V DC / 6 mA Switching setpoint 1/2 (day/night)
Permitted humidity	85 % non-condensing
Protection class	IP 54
Protection category	III (safety extra-low voltage, galvanically isolated)
Permitted ambient temp.	0 to +50 °C
Casing	Surface installation, Polymer, light grey
Dim. mm	W 114 x H 108 x D 56
Weight	250 g
Wiring diagram no.	SS-1039

ETR



■ **Temperature controller ETR**

The controller is freely adjustable within the sensor measuring ranges, with the optional functions of cooling or heating, with adjustable minimum air shut-off.

- Temperature control range
–50 to +150 °C.
□ Appropriate sensors (types LTA, LTK, LTR, see accessories) are available for temperature measurement.

Type ETR	Ref. no. 1438
Supply voltage	10-24 V DC, 6 mA
Analogue outputs	0-10 V DC 10 V / 0.3 mA 24 V / 10 mA
Signal input	10-24 V DC / 6 mA Switching setpoint 1/2 (day/night)
Permitted humidity	85 % non-condensing
Protection class	IP 54
Protection category	III (safety extra-low voltage, galvanically isolated)
Permitted ambient temp.	0 to +50 °C
Casing	Surface installation, Polymer, light grey
Dim. mm	W 114 x H 108 x D 56
Weight	200 g
Wiring diagram no.	SS-1040

■ **Note**

Depending on the fan type to be connected, multiple fans can be connected in parallel to an EDR or ETR.

■ **Necessary accessories for EDR and ETR**

Type NG 24 Ref. no. 1439
Power supply unit for DIN rail mounting, input 100-240 V AC, output 24 V DC / 1.75 A. Required if fan type does not supply 10-24 V DC / 6 mA.

Type WSUP Ref. no. 9990
Week timer

Type WSUP-S Ref. no. 9577
Week timer for DIN rail mounting

■ **Necessary accessories for ETR**

Type LTA 40 Ref. no. 1336
Temperature sensor for outside
Measuring range –20 to +60 °C
Protection class IP 54

Type LTK 40 Ref. no. 1324
Temperature sensor for in-duct installation
Measuring range 0 to +40 °C

Type LTR 40 Ref. no. 1323
Room temperature sensor
Measuring range 0.5 to +40 °C

PU / PA



SU / SA



Basic circuit diagram

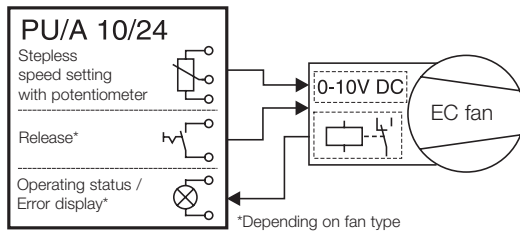

Basic circuit diagram

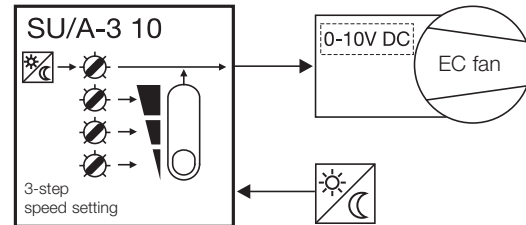

■ Speed-potentiometer PU / PA with additional functions switch and LED

- **Area of application**
For direct control/setpoint specification of EC fans with potentiometer input. Additionally equipped with a release switch and LED display for the operating status (depending on the fan type features).

□ Control with potentiometer

The potentiometer is attached directly to the potentiometer input of the fan control. This has a potentiometer supply of e.g. 10 V DC and an input control signal of 0-10 V DC.

□ Minimum voltage

A second potentiometer is firmly integrated in the PU/PA. The minimum voltage (min. 1.3 V) is steplessly adjustable, thus a reliable motor start-up is guaranteed on the lowest speed setting.

□ Release switch

The rotary knob for the potentiometer is also a pressure switch, which can be used to switch the fan with release input (e.g. 24 V DC) on/off.

□ LED light ring

The colour of the light ring signals the operating status of the fan. For fans with operating signal relay, change from green (normal operation) to red (fault). See technical data for necessary supply voltage.

■ Delivery range

□ LED power supply 10 V

Type PU 10 Ref. no. 1734
Installation standard flush mounted box
Dim. mm W 80 x H 80 x D 21 overhang

■ Type PA 10

Casing Surface installation, Polymer, light grey
Dim. mm W 80 x H 80 x D 65

□ LED power supply 24 V

Type PU 24 Ref. no. 1736
Installation, dimensions see PU 10

■ Type PA 24

Casing, dimensions see PA 10

■ Technical data for all types

Potentiometer 10 kOhm (min. potentiometer approx. 7.9-16.5 kOhm)
A Potentiometer supply of 10 V results in a control voltage 0-10 V DC.
Min. voltage 1.3-6.7 V DC adjustable.
LED supply voltage: 10/24 V DC (P 10/24), min. 6 mA
Permitted ambient temp. 0 bis +40 °C
Protection class IP 40
Wiring diagram no. SS-1000

■ Three-step switch SU / SA 10 V / 0-10 V

□ Area of application

Three-step switch for flush or surface mounting. For three-step control of EC fans or frequency inverters, with a 0-10 V DC control input.

□ Functions

Three different setpoints can be specified/issued using SU/SA. Each step is freely adjustable via a separate potentiometer from 0 to 10 V DC. A week timer (WSUP, WSUP-S, accessories) can also be connected to switch from 3-step day mode to e.g. night mode. The night/reduction mode is freely adjustable using another potentiometer from 0 to 10 V DC.

■ Delivery range

□ Flush mounting

Type SU-3 10 Ref. no. 4266
Installation in deep flush box (D 65 mm)
Dim. mm W 80 x H 80 x D 15 overhang

□ Surface mounting

Type SA-3 10 Ref. no. 4267
Protection class IP 40
Casing Surface installation, polymer, white
Dim. mm W 80 x H 80 x D 60

■ Technical data

for all SU / SA types

Supply input: 10 VDC Ri = 12.5 kOhm (safety extra-low voltage)
Own consumption: 1.5 mA
Control output: 0 to 10 V DC optional via switch or external switchover
Protection class IP 30 when installed
Protection category III
Wiring diagram no. SS-1022

■ Note

Depending on the fan type to be connected, multiple fans can be connected in parallel to a speed-potentiometer or three-step switch.

Differential pressure switch DDS
Type DDS Ref. no. 0445

Area of application

- Complete kit to monitor air filter, system pressure and fan operation.
- Suitable for DDC applications (24 V DC/0.1 A) due to gold-plated connection contacts. Once the unit has been connected conventionally (230 V AC/1.5 A), subsequent use in DDC applications is no longer possible.
- Suitable for applications according to VDI 6022.

Technical data

Adjustable pressure range	50 – 500 Pa
Switching difference Δp	20 Pa
max. operating overpressure	5 kPa
Current	230 V AC 1.5 (0.4) A
	24 V DC 0.1 A
Ambient temp.	-20 to +85 °C
Air flow temp.	-20 to +85 °C
Humidity	0...50% RH, non-condensing
Protection class	IP 54
Dim. mm	Ø 104, D 58
Weight approx.	0.23 kg
Wiring diagram no.	SS-490



Function

Adjustable opener/closer to monitor pressure loss and thus the amount of dust in air filters, the pressure increase of fans and the pressure level within the ventilation system.

Delivery

- Complete kit including:
- Differential pressure switch DDS
 - 4 fastening screws
 - 2 pipe connections
 - Connection pipe Ø 6 mm x 1.5 mm x 2000 mm
 - Drilling template for connecting points
 - Retaining plate + 3 fastening screws
 - 3 screw terminals

One-step thermostat TME 1
Type TME 1 Ref. no. 1334

Area of application

- Robust, electronic thermostat for temperature-dependent on/off operation of fans or heaters. Suitable for installation in humid and dusty rooms. Surface mounting in any position.

Technical data

Voltage	230 V-, 50/60 Hz
Current	16 A
Max. current (AC 3)	6 A
Temperature range	0 to +50 °C
Switching sensitivity	+/- 0.8 K at 20 °C
Protection category	II
Protection class	IP 54
Ambient temp.	0 to +60 °C
Dim. mm	W 82 x H 80 x D 75
Weight approx.	0.2 kg
Wiring diagram no.	SS-701
Connection cable	NYM-0 4 x 1.5 mm ²



Function

- Single step control thermostat for direct switching of one or a number of fans.
- Also suitable for heater control through optional connection.
- Potential-free switch-over contact.

Specification

- Enclosed casing made of impact resistant, light grey polymer. Cable entry on the bottom of casing via self-sealing grommet PG 11.
- Connection via terminal block, after removing the casing cover.

Ventilation hygrostat
Type HY 3 Ref. no. 1359

Ventilation hygrostat
Type HY 3 SI Ref. no. 1360
Internal scale.

Area of application

- Electromechanical humidity controller for on/off operation of fans (in 3 ph. models control via contactor) to reduce the relative humidity in a room through air exchange.

Technical data

Relative humidity level	30 to 90 %
Switching sensitivity approx.	± 6 %
Voltage max.	230 V-, 50/60 Hz
Current	3 A (ind.)
Ambient temperature	0 – 40 °C
Protection class	IP 20
Dim. mm	W 76 x H 76 x D 34
Weight approx.	0.25 kg
Wiring diagram no.	SS-168.1



Specification

- Universal hygrostat housed in an attractive polymer casing for surface mounting. Colour white.
- Setpoint adjustment via external rotary knob. In HY 3 SI via the inner scale.

- Not suitable for dusty or aggressive air.
- Sensor element made of polyamide fibres.
- Also suitable for humidification through optional connection.

Air quality controller

Type ACL Ref. no. 0492

Area of application

- Electronic air quality controller to control:
 - 1 ph. fans up to max. 1 A.
 - 3 ph. fans via contactor.
- For ventilation systems in conference rooms, restaurants, shops, manufacturing plants, living/meeting rooms.

Function

- On and off operation of one or a number of fans in relation to the room's air quality.
- The unit has an integrated sensor which reacts on oxidable gases and pollutants such as carbon monoxide, alcohol, formaldehydes, benzene, solvents, methane, tobacco etc.

Possible settings

- The unit switches the fan on if the set value is exceeded or if the concentration rises quickly.
- Adjustable (from outside) overrun timer after the sensor has switched off.
- Indicator lamp for operation type (automatic/manual) and fan operation and overrun time.
- Functional and operational switch on the front casing

Technical data

Voltage	230 V, 1~, 50/60 Hz
Overrun time, adjustable	1 – 10 min.
Power-up delay	approx. 5 sec.
Current	2 A (ind.)
Protection class	IP 30
Dim. mm	W 125 x H 75 x D 30
Weight approx.	0.2 kg
Wiring diagram no.	SS-485.1



Casing

Compact casing with air exchange slots, made of light grey polymer, for surface installation.

Electronic air flow monitor

Type SWE Ref. no. 0065

Area of application

To monitor air flow in ducting. Open or closed circuit principles are available as options.

Function

The air flow sensor (connected to controller) registers the air flow and compares it with the preset value. That can be set on the front side of the control unit (in the range of 1 – 20 m/s). The relay contacts if the set

value is reached or exceeded. Two LED's show UN and the position of the output relay. It is possible to connect an external failure display via a relay output (1 change-over, voltage free, max. current 5 A / AC 250 V).

Installation

Control unit suitable for mounting in switch cabinet for fixing on a 35 mm support rail. Air flow sensor with mounting rosette for in-duct installation with cable (length 2.5 m; up to

max. 10 m extendible), that is to be connected to the control unit.

Technical data

Voltage	230 V, 1~, 50/60 Hz
Current	5 A (ind.) cos φ 0.4
Setpoint adjustment range	1-20 m/s
Air flow temperature	max. 60 °C
Ambient temperature	max. 60 °C
Protection class	IP 20
Dim. mm	W 35 x H 90 x D 66
Sensor length mm	140
Weight	approx. 0.4 kg
Wiring diagram no.	SS-689.1



Mechanical air flow monitor

Type SWT Ref. no. 0080

Area of application

Mechanical air flow monitor with adjustable trigger power to monitor the minimum air flow velocity in ducting minimum diameter 315.

Design

Robust design with a paddle made of high-grade steel and supplied with mounting plate to fix the unit outside of the ducting.

Function

- Can be used as a switch to make or break circuit connections.
- The unit can be set to respond if a minimum or maximum air flow velocity is achieved.
- Adjustable minimum air flow velocity:
 - Lower than approx. 1.5 m/sec.
 - Higher than approx. 3 m/sec.

Installation

Unit must be installed in a way that the weight of the paddle does not affect the spring mechanism inside the unit.

Technical data

Voltage	24-230 V AC, 50/60 Hz
Current	15 (8) A (ind.)
Air temperature limits	-40...+ 85 °C
Protection class	IP 65
Dim. mm	
- Paddle	W 55, L 200, D 0.15
- Casing	W 140 x H 65 x D 62
Weight	approx. 0.4 kg
Wiring diagram no.	SS-557.1



Differential temp. controller

Type EDTW Ref. no. 1613

Area of application and advantages

- Electronic, stepless differential temperature controller for connection of electronically controlled
 - Ceiling fans and all
 - 1 ph. fans.
- For continuous speed control in relation to the temperature difference.
- Designed for use in combination with ceiling fans or fans which move the room air towards the floor to save heating energy. The unit optimises the difference between the floor and ceiling temperature.

Function

- Stepless speed control between (0 – 100%) in relation to the temperature difference between both temperature sensors and the equalisation with the setpoint specification.
- Includes temperature sensors with a flying lead (1 x 10 m long, for mounting below the ceiling; 1 x 2 m long, for mounting above the floor.
- If the temperature difference rises the fan speed increases proportionally and slows down for decreasing temperatures.
- Proportional range can be adjusted steplessly from 1–10 K.

Technical data

Voltage	230 V, 1~, 50/60 Hz
Current max.	2.5 A (T 40 E)
Adjustable control range	1 – 10 K
Protection class	IP 20
Dim. mm	W 210 x H 85 x D 55
Weight approx.	0.7 kg
Wiring diagram no.	SS-438

Possible settings

- On/off (with function display)
- Automatic/manual operation.
- Reverse of air flow direction.
- Proportional range.
- Summer operation: as manual speed controller. Depending on the fan type, motor humming might be produced.



Casing

Impact-resistant white polymer, for surface and flush mounting.

Copyright The copyright for text, graphic illustrations and photographic material of products lies exclusively with Helios Ventilatoren, 78056 Villingen-Schwenningen · Germany.
Reprints of this catalogue, even in modified form, are only allowed with written authorization through Helios.

Technical modifications All information and illustrations in this catalogue are non-binding and only an approximate description. We reserve the right to make modifications to the delivery item in comparison to the information and illustrations in this catalogue, e.g. with regard to technical data, construction, equipment, material and external appearance.



air technology

Helios Ventilatoren

Lupfenstraße 8
78056 Villingen-Schwenningen
Germany

Phone +49 (0) 77 20 / 606 - 0
Fax +49 (0) 77 20 / 606 - 257

info@heliosventilatoren.de
www.heliosventilatoren.de